

UNIV. OF
TORONTO
LIBRARY

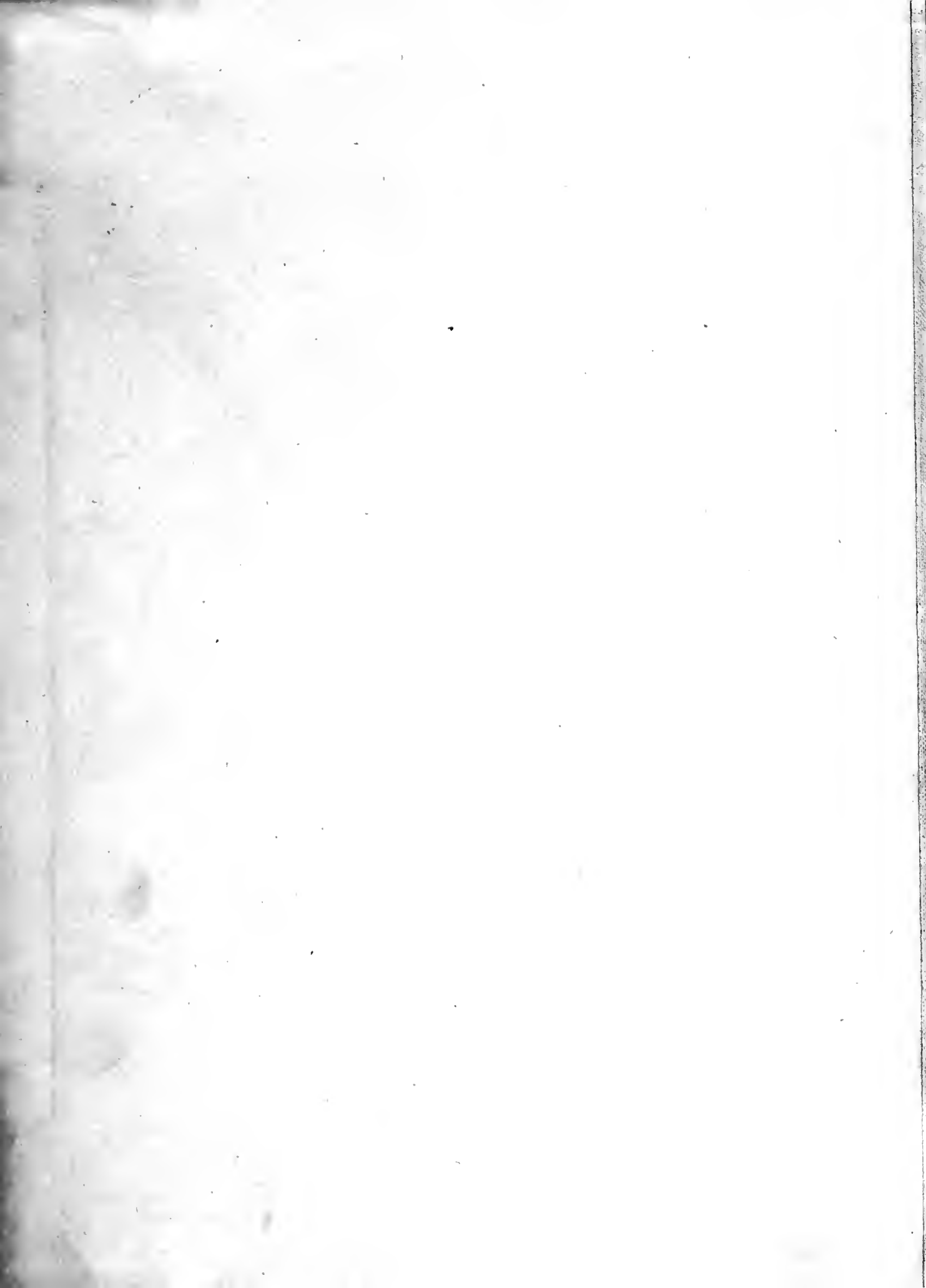

Digitized by the Internet Archive
in 2007 with funding from
Microsoft Corporation

Technol.
A.
Vol. CXIX

January-June
1921

Special Index Issue

THE AMERICAN ARCHITECT

243 West 39th Street
NEW YORK

Founded 1876

Published Fortnightly
in New York

Six Dollars
Yearly

A FOREWORD

THIS index is for the 119th volume of THE AMERICAN ARCHITECT. This series of volumes constitutes an encyclopaedia of architecture in America. They mark the progression from a time when our architecture was but a re-echo of classic precedent to the present day when architecture, as practiced in this country, sets a standard for emulation all over the world.

The development of architecture in America is a reflex of our great advancement as a nation. The progress of THE AMERICAN ARCHITECT has been in keeping with this great advancement. It mirrors today, as it has always done, the highest ideals of a profession that is the oldest of all the arts, and it has blazed the way to a better appreciation of the dignities and the responsibilities of architectural practice.

Its twenty-six issues each year, more than twice as many as any other architectural publication, form a compendium to architectural practice.

Its many illustrations—more than four hundred full page plates and approximately twice as many text illustrations—give to readers a larger volume of suggestive material on architectural subjects than is to be found elsewhere.

Its various departments of Architectural Engineering, Economics as applied to building, Specification and Cubage Costs, place in the hands of subscribers, a fund of material that makes the magazine indispensable to architects, engineers and students who are keenly interested in our architectural development.

EDITORIAL COMMENT

Light-faced figures refer to text pages; bold-faced to serial number

—A—

American Architecture, 147, **2355**.
American Specification Institute, 93, **2353**;
175, **2356**.
Annual Convention of the A. I. A., 515, **2366**.
Architect, The Advancing, 649, **2370**.
Archives Building, A National, 245, **2358**.

—C—

Calder Committee, Report of, 427, **2363**.
Canadian Copyright Law, Proposed, 489, **2365**.
Chicago's Opportunity, 365, **2361**.
Civic Center in New York, 275, **2359**.
Confidence, 319, **2360**.
Confidence, Commonsense and Co-operation,
43, **2351**.
Congress and the Housing Shortage, 44,
2351.
Contractors Adopt Code of Ethics, 395, **2362**.

—D—

Daylight Saving, 275, **2359**.
Digest, A Nationwide, 453, **2364**.

—E—

Elimination of Waste in Building Industry,
555, **2367**.
Ethics in Architectural Design, 147, **2355**.
Europe Turns to American Architects, 69,
2352.
Excessive Bidding, 70, **2352**.

—F—

Farm Buildings, Improving, 613, **2369**.
Farm Conditions, Improving, 245, **2358**.
Fine Arts in the Government, 94, **2353**.
Fund to Assist Young Architects, 43, **2351**.

—G—

Greenwich Village, Los Angeles, 175, **2356**.

—H—

Holy Land in 1920, 122, **2354**.
How Much Will It Cost? 44, **2351**.

—I—

Ignoring Our American Art, 121, **2354**.
Illinois Chapter, A Timely Resolution of, 427,
2363.

—L—

League of New York Artists, 489, **2365**.

—M—

Military Honors to an Artist, 453, **2364**.

—N—

National Duty, A, 585, **2368**.
New Jersey Abolishes State Architect, 555,
2367.

—O—

Organized Labor Enters Field of General
Contracting, 205, **2357**.

—P—

Personal Equation Editorial by Sullivan
Jones, 176, **2356**.
Philadelphia Building Trades Work Toward
Building Resumption, 365, **2361**.
Plain Duty, 275, **2359**.
Prices, 94, **2353**.
Public Library, For What Is It Maintained?
585, **2368**.

—S—

Sketching for Architects, 515, **2366**.
Skilled Workmen for the Building Trades,
93, **2353**.
State Registration Fails in Indiana, 427,
2363.
State Societies, 649, **2370**.
State Societies and the Institute, 613, **2369**.

—T—

Traffic Congestion in New York, To Relieve,
395, **2362**.
Transportation Tangles, Reducing, 148, **2355**.

—W—

What Is a "Public?" 69, **2352**.
Where Does the Evil Lie? 121, **2354**.

TEXT ACCORDING TO SUBJECT

Light-faced figures refer to text pages; bold-faced to serial number

—A—

Ambassador Hotel, The. Warren & Wet-
more, Architects, 644, **2370**.
American Chippendale, Some Examples of,
321, **2360**.
American Institute of Architects, Fifty-
fourth Annual Convention of, 573, **2368**.

American Specification Institute, 172, **2356**;
320, **2360**.
American Specification Institute, Announce-
ment by Board of Governors of, 670, **2370**.
Architect and Engineer, Relation Between.
By Kort Berle, 4, **2350**.
Architects, What They May Think About in
1921, 11, **2350**.

Architectural Interiors of the United States
Shipping Board S. S. "Hawkeye State."
By Francis B. Ellis, 446, **2364**.
Architectural League of New York, Thirty-
sixth Annual Exhibition, 475, **2365**.
Architectural Management. By Francis B.
Ellis, 397, **2362**; 428, **2363**.
Architectural Quicksands. By Clinton H.
Blake, Jr., 390, **2362**; 484, **2365**.

TEXT ACCORDING TO SUBJECT

(Continued)

Architectural Registration Boards, National Council of, 513, **2366**; 580, **2368**.
 Architecture and Building, Relation Between By Louis Jay Horowitz, 2, **2358**.
 Architecture and the Motion Picture. By Carl A. Ziegler, 543, **2367**.
 Architecture, Case for, 238, **2358**.
 Architecture, Fashionable, 443, **2364**.
 Architecture in 1921, Practice of. By C. H. Blackall, 1, **2350**.
 Architecture of the Small College. By S. B. P. Trowbridge, 614, **2369**.
 Art-Teaching Experiments in the Schools, 89, **2353**.

-B-

Baum, Dwight James, Architect, Notes on Work of, 557, **2367**.
 Beauty, The Basis of, 263, **2359**.
 Beaux-Arts Institute of Design, 276, **2359**; 313, **2360**; 516, **2366**; 609, **2369**; 651, **2370**.
 Boston College, The New. By Ralph Adams Cram, 615, **2369**.
 Building Guilds and Housing in England, 304, **2360**.
 Building Material Costs in 1921. By A. R. Kreichbaum, 19, **2350**.
 Building Outlook in the Middle West, 16, **2350**.
 Buildings on Narrow Streets, High. By Harvey W. Corbett, 603, **2369**.
 Business Conditions, 326, **2360**.

-C-

Chicago Bridges, 552, **2367**.
 Competition for School Group, New Britain, Conn., 59, **2352**.
 Color in Architecture, 202, **2357**.
 Congestion Defended by Landscape Architect, 454, **2364**.
 Construction Costs, Some Solid Facts on. By F. E. Davidson, 268, **2359**.
 Craftsmanship, The True. By "Travi," 9, **2350**.
 Creating a New Investment Center in New York, 617, **2370**.

-D-

Dunning, N. Max, Work of, 111, **2354**.

-E-

Entasis, Calculation of. By J. T. Tubby, 550, **2367**.

-F-

Factory Production Applied to Housing. By Robert Tappan, 62, **2352**.
 Financial Outlook. By Francis H. Sisson, 7, **2350**.

-G-

Gutham National Bank Building. Sommerfeld & Streckler, Architects; Kenneth Murchison, Consulting Architect, 350, **2361**.

-H-

Hospital Construction Affecting Distribution of Food, 234, **2358**.
 Hotel Webster, Chicago. Fridstein & Co., Engineers, 383, **2362**.

-I-

Impression of the Washington Convention, An. By Howard Van Doren Shaw, 620, **2369**.

-J-

Japanese Life, Insight Into, 39, **2351**.

-L-

Labor Attempts to Organize Architectural Draftsmen, 36, **2351**.
 Legal Regulation of Standards of Architectural Practice. By Emory Stanford Hall, 199, **2357**.
 Louis XV Paneled Room, A, 586, **2368**.

-M-

McIntire, Samuel. By W. H. Hunt, 415, **2363**.
 Memorial Bridge Across the Hudson River at New York, Proposed. Alfred C. Bosson, Architect, 423, **2363**.
 Minneapolis Architects Have a Colony, 88, **2353**.

-N-

New York District Conference of Building Industry, 139, **2355**.
 Noyes-Buick Building, Boston, Mass. Arthur H. Bowditch, Architect, 195, **2357**.

-O-

Old Salem Houses. By W. H. Hunt, 507, **2366**.
 Own Your Home Small Home Competition, Prize Designs of, 321, **2360**.

-P-

Paris, Extension of, 64, **2352**.
 Personal Equation, What About the? 324, **2360**.

Prague—As a City of the Baroque, Part III. By Selwyn Brinton, 343, **2361**.
 Prague, Housing Problem Met in, 66, **2352**.
 Prices, Study of. By Edmund D. Fisher, 107, **2353**, 133, **2354**, 163, **2355**.
 Proposal Worth Millions, An Intangible, 366, **2361**.

-R-

Real Estate Outlook for 1921. By Joseph P. Day, 7, **2350**.
 Reconstruction in Northern France. By Ralph Fanning, 167, **2356**.
 Registration Matters, Architectural, 116, **2354**.
 Research and Educational Hospitals of Illinois. Schmidt, Garden & Martin, Architects, 223, **2358**.
 Roman Catholic Church of St. Clare, Staten Island. Eggers & Higgins, Architects, 41, **2351**.

-S-

School Buildings in Syracuse, N. Y., Two. James A. Randall, Architect, 89, **2353**.
 Scottish Rite Cathedral Competition, Portland, Oregon, Extracts from Competition Program of, 358, **2361**.
 Side Trip in Building. By Thomas Crane Young, 85, **2353**.
 Southern Intercollegiate Competitions, 523, **2366**.
 Specifications, Department of, 667, **2370**.
 Standardization of Parts in House Construction. By D. Knickerbacker Boyd, 200, **2357**.
 State Societies, 629, **2369**.
 Straus, S. W., & Co., Building. Warren & Wetmore, Architects, 637, **2370**.

-T-

Trade Agreements in Chicago, 650, **2370**.
 Trained Observer? Are You a, 150, **2355**.

-U-

Unwise Building Laws, Written and Unwritten. By Grosvenor Atterbury, 90, **2353**.
 Urban Congestion—A Study of Its Causes and Suggestions for Its Eradication. By John Irwin Bright, 581, **2368**.

-W-

War Memorials. Cass Gilbert, Jr., 33, **2351**.
 Westward—Ho! 149, **2355**.

-Z-

Zoning Regulations, Simpler. By Herbert S. Swan, 454, **2364**.

TEXT ACCORDING TO AUTHOR

Light-faced figures refer to text pages; bold-faced to serial number

-A-

Atterbury, Grosvenor:—
 Building Laws, Unwise, Written and Unwritten, 90, **2353**.

-B-

Berle, Kort:
 Architect and Engineer, Relation Between, 4, **2350**.
 Blackall C. H.:—
 Architecture in 1921, Practice of, 1, **2350**.
 Blake, Clinton H., Jr.:—
 Architectural Quicksands, 390, **2362**; 484, **2365**.
 Boardman, Charles S.:—
 Steel Sheet Piling, 123, **2354**.
 Bosson, Alfred C.:—
 Memorial Bridge Across the Hudson River at New York, Proposed, 423, **2363**.
 Bowditch, Arthur H.:—
 Noyes-Buick Building, Boston, Mass., 195, **2357**.

Boyd, D. Knickerbacker:—
 Standardization of Parts in House Construction, 200, **2357**.
 Bright, John, Irwin:—
 Urban Congestion—A Study of Its Causes and Suggestions for Its Eradication, 581, **2368**.

Brinton, Selwyn:—
 Prague—As a City of the Baroque, 343, **2361**.
 Bryant, Henry F.:—
 Noyes-Buick Building, Boston, Engineering Features of, 207, **2357**.

-C-

Corbett, Harvey W.:—
 Buildings on Narrow Streets, High, 603, **2369**.
 Cram, Ralph Adams:—
 Boston College, The New, 615, **2369**.

-D-

Davidson, F. E.:—
 Construction Costs, Some Solid Facts on, 268, **2359**.
 Day, Joseph P.:—
 Real Estate Outlook for 1921, 7, **2350**.

-E-

Eggers & Higgins:—
 Roman Catholic Church of St. Clare, 41, **2351**.
 Ellis, Francis B.:—
 Architectural Interiors of the United States Shipping Board S. S. "Hawkeye State," 446, **2364**.

Architectural Management, 397, **2362**; 428, **2363**.
 Ericson, Lamert T.:—
 Creosoted Wood Block Factory Floors, 212, **2357**.

-F-

Fanning, Ralph:—
 Reconstruction in Northern France, 167, **2356**.
 Farwell, Milo S.:—
 Reinforced Concrete, Short Cuts for Calculating and Estimating, 251, **2358**.
 Fisher, Edmund D.:—
 Prices, Study of, 107, **2353**; 133, **2354**; 163, **2355**.
 Fridstein & Co.:—
 Hotel Webster, Chicago, 383, **2362**.

-G-

Gardner, Henry A.:—
 Paints and Varnishes, Fire-Resisting, 594, **2368**.
 Gilbert, Cass, Jr.:—
 War Memorials, 33, **2351**.

TEXT ACCORDING TO AUTHORS

(Continued)

—H—

- Hall, Emory Stanford:—
Architectural Practice, Legal Regulation of Standards, 199, **2357**.
- Horowitz, Louis Jay:—
Architecture and Building, Relation Between, 2, **2350**.
- Hubbard, Charles L.:—
Heating and Ventilating Equipment, 367, **2361**; 399, **2362**.
Heating and Ventilating Industrial Buildings, 71, **2352**; 95, **2353**.
Refrigeration, 528, **2366**; 587, **2368**; 654, **2370**.
- Hunt, W. H.:—
McIntire, Samuel, 415, **2363**.
Old Salem Houses, 507, **2366**.

—K—

- Kriechbaum, A. R.:—
Building Material Costs in 1921, 19, **2350**.

—M—

- Matteson, Victor Andre:—
Architect and Engineer, 51, **2351**.
- Mensch, L. J.:—
Warehouse for The National Tea Company, Chicago, 492, **2365**.

—N—

- Nimmons, George C. & Co.:—
Federal Electric and Walker Vehicle Plants, Chicago, 559, **2367**.

—O—

- Owen, Allan F.:—
Hollow Tile Floor Construction, An Improvement in, 26, **2350**.

—R—

- Randall, James A.:—
School Buildings in Syracuse, N. Y., Two, 89, **2353**.
- Rohm & Son, Jean B.:—
Warehouse for The National Tea Company, Chicago, 492, **2365**.

—S—

- Schmidt, Garden & Martin:—
Research and Educational Hospitals of Illinois, 223, **2358**.
- Shaw, Howard Van Doren:—
Impression of the Washington Convention, An, 620, **2369**.
- Sisson, Francis H.:—
Financial Outlook, 6, **2350**.
- Sommerfeld & Steckler:—
Gotham National Bank Building, New York, 350, **2361**.
- Swan, Herbert S.:—
Zoning Regulations, Simpler, 454, **2364**.

—T—

- Tappan, Robert:—
Factory Production Applied to Housing, 62, **2352**.
- Trowbridge, S. B. P.:—
Architecture and the Small College, 614, **2369**.
- Tubby, J. T.:—
Entasis, Calculation of, 550, **2367**.

—W—

- Warren & Wetmore:—
Ambassador Hotel, New York City, 644, **2370**.
- Strans, S. W., & Co., Building, New York City, 637, **2370**.
- Willard, A. C.:—
Warm-Air Furnaces, Rating and Comparing, 155, **2355**.

—Y—

- Young, Thomas Crane:—
Side Trip in Building, 85, **2353**.

Z

- Ziegler, Carl A.:—
Architecture and the Motion Picture, 543, **2367**.

CURRENT NEWS

Figures refer to text pages

—A—

- Alabama Architects, 188.
- American Academy in Rome, 159.
- American Federation of Arts, Convention of, 439.
- American Standard of Living, 31.
- American Students to Help France Rebuild, 597.
- America's Gift to the World, 337.
- Ancient Stone Plaque, 632.
- Architects Elect New Officers, 569.
- Architects Join National Group, 257.
- Architects and Engineers Organize, 438.
- Architects' "House Organ" Issued, 629.
- Architect's Service, The, 375.
- Architect's Service Bureau, An, 596.
- Architects to Compete, Manhattan College, 258.
- Architect Wins Prize for Writing Best Play, 336.
- Architectural Association Elects Officers, 375.
- Architectural Exhibit for Ghent, Belgium, 52.
- Architectural League Exhibition, 376.
- Architectural League of Indianapolis, 30.
- Architectural Water Colors, 187.
- Architecture, Growing Appreciation for, 596.
- Armour Institute of Technology, Head of, 569.
- Art Appreciation Lacking, 190.
- Art Center Getting Settled, 376.
- Art Historian Dies, 257.
- Art in the Home, 375.
- Artists Divide Auto Prize, 500.
- Association of Collegiate Schools of Architecture, Annual Meeting of, 467.
- Australian Artificers, 537.
- Automatic Doorsill Permits Exit Only, 162.

—B—

- Back Door, Neglect of, 129.
- Balsa Wood Lighter than Cork, 161.
- Basements, To Beautify, 297.
- Beauty and Utility, 258.
- Better Distribution of Aliens Aimed at, 79.
- Billboard Nuisance in Massachusetts, 161.
- Billions for Construction in 1921, 31.
- Bill to Register Builders in New York, 500.
- Birren Prize, 467.
- Bismarck's Unique Park, 357.

—C—

- Borglum to Carve Army on Mountain, 162.
- Boston Architectural Show, 257.
- Boston Society of Architects Meets, 335.
- Brangwyn to Decorate Missouri Capitol, 129.
- Bridge for the U. S., Highest, 438.
- Bridge Resists Floods for Ages, 80.
- Brooklyn's Plymouth Church Rebuilding, 104.
- Builders Form New Organization, 500.
- Building Now, Wisdom of, 255.
- Building Officials' Conference, 438.
- Building with Government Aid, 255.
- Bungalow on Factory Roof, 297.
- Bureau of Housing, 105.
- Burning Coal Mine Under City, Fighting, 131.
- Burroughs Memorial, Plan, 631.
- Cabinet May Urge War Reductions, 502.
- Calder Committee Suggests Remedy for Housing Shortage, 469.
- Cambridge Architect Wins, 337.
- Carnegie Institute, 439.
- Carnegie Institute Exhibit, 376.
- Chicago Architectural Exhibit, 159.
- Chicago Architectural Exhibit—1921—The 34th Annual, 468.
- Chicago News Notes, 53, 106.
- Chicago Notes of Interest, 336.
- Chicago's Field Museum, 596.
- Chinese Art, 536.
- Circulating of Pictures, 162.
- City Bureau to Plan Homes, 105.
- City Plan for St. Paul, 438.
- City Planning in Kansas, 470.
- Civic Federation to Discuss Labor Problems, 104.
- Coal, Plan to Pipe, 296.
- Cocanut Palm, The Versatile, 297.
- Competition, Small House, 29.
- Concrete Building, Largest, 31.
- Construction Division U. S. A. Holds Reunion, 103.
- Contractor, Ethics for the, 295.
- Corinthian Capital, The Origin of the, 295.
- Country's Oldest House, This, 579.
- Craue, R. T., Buys Westover, 469.
- Danes Erect Obelisk, 80.
- Doctors' Co-operative Building, 499.
- Dutch Dry the Zuyder Zee, 215.

—D—

—E—

- Efficiency Body Favors World Fair in 1926, 378.
- Engineer, Definition of 2000 Years Ago, 30.
- English Architects Meet, 630.
- Estate Management, Will Teach, 407.

—F—

- Factory Machinery No Longer Black, 130.
- Fine Exchange of Unselfish Recognition, A, 568.
- Finns Develop Own Architecture, 296.
- Fire Loss, 1920, Third Largest on Record, 470.
- Forrests in Northwest, Vast, 104.
- France Plans Home for Married Women Only, 104.
- French Town, To Build Model, 362.
- French Village Has American Aid in Memorial, 190.

—G—

- Georgia Architects Organize, 187.
- Georgia School of Technology, 536.
- Germany Wants Skyscrapers, 215.
- Gobelins, Trying to Save, 105.
- Gobelin Works Admit Women, 80.
- Good Housing Hurt by Shortage, 255.
- Gotham National Bank, 53.
- Government Service, For, 408.

—H—

- Health Commissioner Invokes Millionaires, 191.
- Henry Reinhardt, Art Dealer, Dead, 103.
- High Bridge Saved, 159.
- High School Competition, 376.
- Historic St. Paul's, in Washington, D. C., Destroyed by Fire, 570.
- Home Builders, To Help, 375.
- Home Building by Advertising Campaign, To Push, 499.
- Hotel Entrances, 189.
- House Managers for the Dutch, 217.
- House Names, 407.
- Housing and Garden City League Formed, 160.
- Housing Conference, 105.
- Housing in Germany, 104.

CURRENT NEWS

(Continued)

Housing Problem in America, 256
 Housing Problems to Be Considered, 53.
 Housing Resolutions Passed, 256.
 How We Look from Above, 295.
 Hudson River to Be Bridged, 191.

—I—

Illinois Chapter Architects Hold Meeting, 338.
 Imports of Art Works, 189.
 Indians Had 45 Story Apartment, 132.
 Industrial Art at Museum, 103.
 Industrial Teachers' Scholarships in New York, 630.
 Information Bureau for New York State Contractors, 569.
 International Congress of Cities in Paris, 160.
 International Situation, 502.
 Inter-State Bridge, Maine, 161.
 Italy Wants Art Treasures, 615.

—J—

Jamestown Architects Organize, 499.
 Japanese Houses, Signs on, 216.
 Jersey City Building Active, 160.
 Jersey City Planning, 160.
 John Hopkins Plans Building Costing \$11,500,000, 52.

—K—

Kansas Architects Annual Meeting, 188.
 Kansas City Architects Announce New Service Bureau, 569.
 Kitchen Marathon Two Miles, 104.

—L—

Landmarks for the Aviator, 297.
 Langley, Batty, Two Books Illustrating Designs by, 631.
 Leases, \$600,000 in, 499.
 LeBrun Scholarship Award, 191.
 Legacy to Posterity, A, 583.
 Leviathan, Nobody Wants the, 467.
 Library of Congress Wants The American Architect, 52.
 Lumbermen to Reduce Building Costs, 104.

—M—

Marriage Profitable in Berlin, 336.
 McFadden Art Disposal, 375.
 Memorial Competition, 296.
 Memorial Plans, 439.
 Michigan Chapter, A. I. A., 632.
 Model City for China, 272.
 Moving a City, 536.
 Mural Painters Appointed, 438.
 Museums, Additions to, 377.

—N—

National Arboretum, 188.
 National Building Code, 256.
 National Landmark, A, 570.
 National Memorials Committee Issues Warning, 569.
 Nebraska A. I. A. Holds Annual Election, 470.
 Nebraska Chapter Elects Officers, 159.
 New York Miscellanies, 53.

New York Rent Laws Upheld, 377.
 New York Society of Architects, 29, 159, 408, 568.
 New York Society of Architects, Annual Dinner of, 597.
 New York Society of Architects, Year Book, 597.
 New York State Association Meets, 336.
 Niagara Power, 161.
 Noises, Silencer for Street, 131.

—O—

Omaha Art School, 189.
 Origin of "Checks," 105.
 Our Most Popular Building, 537.
 Own Your Home, 377.
 Own Your Home Competition, 215.

—P—

Painters Hear Lecture on Color Dimensions, 377.
 Paris Prize, Society of Beaux-Arts Architects, 187.
 Paris Salon, American Architects Invited to Exhibit in, 129.
 Paris to Have Mosque, 631.
 Paris Walls for War Area Homes, 162.
 Peace Gardens for War Gardens, 536.
 Pennsylvania Academy Exhibit Announced, 79.
 Permanent State Buildings in Washington, D. C., A Proposed Erection of, 631.
 Personalities of Cities, 538.
 Philadelphia Architects Co-operate with Labor, 189.
 Philadelphia Architects Join Exposition, 103.
 Philadelphia Architects Receive Gold Medal Award, 499.
 Philadelphia's Exhibit, 335.
 Philadelphia's New Art Museum, 596.
 Portland, Ore., to Get City Plan, 468.
 Poverty of Immigrants, 257.
 Prague, In, 79.
 Prehistoric Village Found, 79.
 Publicity by Contractors, 191.
 Pueblo Architecture in Concrete, 296.
 Pullmans Used as Houses, 538.
 Puppets in Egyptian Tombs Show Ancient Conditions, 161.

—R—

Razing Paris Forts, 409.
 Real Estate Lecture Course, Y. M. C. A., 52.
 Realistic Art Is Urged, 537.
 Reconstruction in Belgium, 80.
 Reduce Excessive Building Costs, 256.
 Reims, Two Churches Under, 631.
 Rembrandt, A Rare, Stolen, 105.
 "Rembrandt" Found, 132.
 Rheims Cathedral, Cannot Match Stone in, 597.
 Ricker Library of Architecture, 189.
 Rome Extending Her Area, 272.
 Roosevelt Memorial in Washington to Surpass All, 160.
 Roosevelt Memorial Proposed, 52.
 Roosevelt Memorial Site, 536.
 Rotch Scholarship Award, 632.
 Rotch Scholarship Examinations, 407.
 Roumanian Parlor Stoves, 215.

—S—

St. Lazare Prison Is to Be Demolished, Famous, 377.
 St. Louis "Own Your Home Exposition," 463.
 San Francisco Is Unearthed, Ancient, 349.
 Sargent Returns to Boston, 188.
 Scholarships, M. I. T., 438.
 School Building Program for New York, 191.
 Schoolhouse, Good-Bye to Little Red, 296.
 Scientists to Delve in Ruins of Old Palestine, 408.
 Seattle A. I. A. Elects, 335.
 Skyscraper, Birth of the, 408.
 Skyscrapers, Rue de Rivoli Wants, 190.
 South America Offers Inducements to Immigrants, 537.
 Southern California Chapter's Officers, 187.
 Spain to Use Electricity, 362.
 Spanish Missions to Be Restored, 216.
 Specification Writers Reports Progress, Organization of, 407.
 Speir, Oswald, Dead, 187.
 Stage Settings from Blocks, 296.
 Standard of Living, 255.
 State Financing for Home Building, Favors, 501.
 Summer Classes in Architecture, 568.

—T—

Tax Exemption Passed in New York City, 409.
 Teacherages Are Gaining Favor, 439.
 Teach Housing in Schools, 256.
 Technical Man in War Department, Want, 322.
 Tenement, Revamping the, 257.
 Thessalian Temple, Unearth, 632.
 Tower Made of Tree Trunk, 536.
 Traveling Exhibits of Art, 130.
 Treasures of Loreto Are Reduced to Ashes, 337.

—U—

U. S. Wearing Away, 162.
 University of Chicago, To Enlarge, 597.
 Upbuilding the Nation, 255.

—V—

Virginia Chapter Names Officers, 188.

—W—

Washington State Society Elects, 188.
 Westminster Acknowledges American Gift, 129.
 Whale Bones for Building, 337.
 Where Land Costs Most, 536.
 White House Again to Become Mecca Under the Hardings, 337.
 Wichita Architects Hold Election, 188.
 William Willett Dead, 467.
 Workhouse Closes, Famous, 79.
 World's Fair in Philadelphia, 160.
 World's Fair, Permanent Buildings for, 189.
 World Trade, To Restore, 469.

—Z—

Zoning, Saving by, 295.

CRITICISM AND COMMENT

American Specification Institute, Communications from Architects, 67, 119, 283, 322, 375.
 Appreciative Letter from an Old Subscriber. By James M. Macqueen, 490.

Architect and Engineer. By Victor Andre Matteson, 51.
 Communication from an Old Subscriber. By William H. Mersereau, 595.

"Hawkeye State," The. By Edwin D. Weary, 595.

"Westward-Ho," An Echo from, 303.

DEPARTMENT of ARCHITECTURAL ENGINEERING

Light-faced figures refer to text pages; bold-faced to serial number

- Ambassador Hotel and the Architectural Engineer, The, 659, **2370**.
 American Engineering Standards Committee, The, 466, **2364**.
 Bituminous Concrete Foundation, Advantages of, 534, **2366**.
 Book Notes—A Book of Ceilings, 298, **2359**; Hendrick's Commercial Register for 1921, 298, **2359**; Red Lead, and How to Use It in Paint, 497, **2365**.
 Building Codes, Inconsistencies of Some, 463, **2364**.
 Cement Slabs, New Design Data for, 287, **2359**.
 Central Warehouse, Chicago, Shoring and Underpinning the, 592, **2368**.
 Cleveland Auditorium, 21, **2350**.
 Coal Bin of Unusual Design and Construction, A Concrete, 621, **2369**.
 Colored Wall Plaster, 661, **2370**.
 Concrete Strength, Effect of Colorings on, 661, **2370**.
 Crane, Making the, Safe, 154, **2355**.
 Creosoted Wood Block Factory Floors, By Lambert T. Ericson, 212, **2357**.
 Elevator Motors, Controls for A. C., 434, **2363**.
 Engineers and Architects, Estrangement Between, 294, **2359**.
 Federal Electric and Walker Vehicle Plants, Chicago, The, George C. Nimmons & Co., Architects, 559, **2367**.
 Fire Precautions in a Woodworking Plant, 331, **2360**.
 Fire Tests, 498, **2365**.
 Flat Slab Floors, 100, **2353**.
 Flues, Proper Size and Design for, 158, **2355**.
 Frame Roof a Thatched Appearance, Giving a, 373, **2361**.
 Garage Fire Record, 76, **2352**.
 Generator Units, Emergency, 334, **2360**.
 Good Design Increases Rental Values, 151, **2355**.
 Heating and Ventilating Equipment, By Charles L. Hubbard, 367, **2361**; 399, **2362**.
 Heating and Ventilating Industrial Buildings, By Charles L. Hubbard, 71, **2352**, 95, **2353**.
 High Bridge, Fate of, 45, **2351**.
 Hollow Tile Floor Construction, An Improvement in, By Allan F. Owen, 26, **2350**.
 Lighting Fixtures, New Idea in, 50, **2351**.
 Linoleum and Its Proper Application, 565, **2367**.
 Metal Lath to Avoid Plaster Cracks, Application of, 246, **2358**.
 Method of Securing Weather-tight Contact Between Swinging Doors, 534, **2366**.
 Motor Transport Industry, A New Building for the, 429, **2363**.
 National Safety Council, 1921 Campaign, 405, **2362**.
 Noyes-Buick Building, Boston, Engineering Features of, By Henry F. Bryant, Engineer, 207, **2357**.
 Overhead and Underground Streets for New York, 463, **2364**.
 Paints and Varnishes, Fire-Resisting, By Henry A. Gardner, 594, **2368**.
 Pittsburgh Changes Regulation on Wall Thickness, 535, **2366**.
 Plaster Walls, Preventing Cracks in, 186, **2356**.
 Raising and Shoring a Fireproof School House, 464, **2364**.
 Refrigeration, By Charles L. Hubbard, 528, **2366**; 587, **2368**; 654, **2370**.
 Reinforced Concrete Against Electrolysis, Protection for, 498, **2365**.
 Reinforced Concrete Construction, Modern Practice in, 177, **2356**.
 Reinforced Concrete, Short Cuts for Calculating and Estimating, My Milo S. Farwell, 251, **2358**.
 Relative Heat Conductivities of Building Materials, 78, **2352**.
 Sheathing and Wall Board, Relative Strength of, 498, **2365**.
 Single Doors for Entrances to School Buildings, 534, **2366**.
 Spray Painting, Recent Developments in, 157, **2355**.
 Stairs, The Rise and Run of, 661, **2370**.
 Steel Forms for Concrete Columns and Floor Slabs, 332, **2360**.
 Steel Sheet Piling, By Charles S. Boardman, 123, **2354**.
 Theatre, Safety in a Modern, 292, **2359**.
 Tile and Concrete Floor Shows to Advantage Under Test, 327, **2360**.
 Ventilation of the Home Office Building of the Travelers Insurance Company, Hartford, Conn., 429, **2364**.
 Warehouse for The National Tea Company, Chicago, Jean B. Rohm & Son, Architects; L. J. Mensch, Engineer, 492, **2365**.
 Warm-Air Furnaces, Rating and Comparing, By A. C. Willard, 155, **2355**.
 Wrought Iron, How It Is Made, 101, **2353**.

ILLUSTRATIONS ACCORDING TO AUTHORS

Figures refer to the number of the issue, not to the text pages

- Albro, Lewis Colt:—
 Mendleson Memorial Chapel, Loudenville, N. Y., 2368.
 Asheim, Leonard:—
 Fire and Police Station for the City of Bridgeport, Conn., 2369.
 Barber, Donn:—
 Hartford Times Building, Hartford, Conn., 2365.
 Barnard, John:—
 Second Prize, Brick House, Own Your Home Small House Competition, 2360.
 Bates & How:—
 House of Mr. Chapin S. Pratt, Bronxville, N. Y., 2365.
 Baum, Dwight James:—
 House of Mr. John W. Griffin, Fieldston, N. Y., 2367.
 House of Mr. R. E. Lewis, Hartsdale, N. Y., 2367.
 House of Mr. M. A. Shea, Fieldston, N. Y., 2367.
 Riverdale Country Club, Riverdale, N. Y., 2367.
 Blackall, Clapp & Whittmore:—
 Broadway Theatre, South Poston, Mass., 2369.
 Boehm, G. A. and H.:—
 Store of Richard Hudnut, New York, 2364.
 Bowlitch, Arthur H.:—
 Noyes-Buick Building, Boston, Mass., 2357.
 Buchman & Kahn:—
 Borden Building, New York City, 2365.
 House of Mr. Herman Younker, Elmsford, N. Y., 2365.
 Childs & Smith:—
 First National Bank, Menasha, Wis., 2351.
 House of Mr. G. S. Gaylord, Neenah, Wis., 2369.
 House of Mr. A. C. Gilbert, Neenah, Wis., 2351.
 House of Mr. Ralph Isham, Santa Barbara, Cal., 2351.
 House of Mr. Mowry Smith, Menasha, Wis., 2364.
 Menasha Cafe, Menasha, Wis., 2364.
 Cross & Cross:—
 Guaranty Trust Company, Fifth Avenue, New York City, 2365.
 Davis, McGrath & Kiesling:—
 Community Building, Flint, Mich., 2365.
 Industrial Savings Bank Building, Flint, Mich., 2365.
 Dies, J. Ivan and Maier, E. J.:—
 Second Prize, Frame House, Own Your Home Small House Competition, 2360.
 Dunning, N. Max:—
 American Book Co., Chicago, 2356.
 Bethany Bible School, Chicago, 2354.
 Dixon National Bank, Dixon, Ill., 2356.
 Dixon Telephone Co., Dixon, Ill., 2356.
 House of Mr. C. D. Barnes, Kenosha, Wis., 2359.
 House of Mr. F. C. Traver, Kenilworth, Ill., 2354.
 House of Mr. Robert E. Ward, Wilmette, Ill., 2354.
 Kenosha Hospital, Kenosha, Wis., 2356.
 National Cloak & Suit Co., Kansas City, Mo., 2354.
 Newell Memorial Chapel, Kenosha, Wis., 2356.
 Shelter House, Kenosha, Wis., 2357.
 Simmons Mfg. Co., Kenosha, Wis., 2354.
 Stromberg Motor Device Co., Chicago, 2356.
 N. Max Dunning & John W. McKeeknie:—
 House of Mr. Robert J. Thorne, Lake Forest, Ill., 2359.
 Eggers, O. R.:—
 Drawings of Early American Architecture: Old Shop, Litchfield, Conn., 2350.
 Door of a Dutch Farm House, North Paterson, 2351.
 Trinity Church, Newport, R. I., 2352.
 Doorway, Trinity Church, Newport, R. I., 2353.
 Old State House, Newport, R. I., 2354.
 A Street in Newport, R. I., 2355.
 Bilop House, Staten Island, N. Y., 2356.
 St. Andrew's Church, Staten Island, N. Y., 2357.
 Old Tavern, Rossville, Staten Island, 2358.
 Old Dutch Farm House, Staten Island, 2359.
 Christ Church, Philadelphia, 2361.
 St. Peter's Church, Philadelphia, 2362.
 Christ Church and Graveyard, Philadelphia, 2363.
 Old State House, Philadelphia, Pa., 2364.
 Pennsylvania Hospital, Philadelphia, Pa., 2365.
 Old Custom House, Philadelphia, Pa., 2366.
 Old State House, Philadelphia, Pa., 2367.
 Doorway to Fairfax House, Alexandria, Va., 2368.
 Kitchen Wing, Mount Vernon, Va., 2369.
 Christ Church, Alexandria, Va., 2370.
 Fridstein & Co.:—
 Hotel Webster, Chicago, 2362.
 Green, James C.:—
 House of Mr. Duane Armstrong, Greenwich, Conn., 2365.
 Gregory, Julius:—
 House of Mr. Clarence McDaniel, Hartsdale, N. Y., 2362.
 Holabird & Roche:—
 Building for Beckley-Ralston Co., Chicago, 2364.
 Building for R. T. Ederer Co., Chicago, 2364.
 Building for Maxwell Sales Co., Chicago, 2364.
 House for Mr. Louis A. Ferguson, Evanston, Ill., 2363.
 House of Mr. Joseph E. Tilt, Chicago, 2363.
 Wesley Foundation, University of Illinois, Urbana, Ill., 2364.
 Hood, Raymond M.:—
 House of Mr. Cyril Crimmins, Noroton, Conn., 2359.
 Jackson, John F.:—
 House of Mr. E. L. Woodworth, Passaic, N. J., 2364.
 Justement, Louis:—
 First Prize, Frame House, Own Your Home Small House Competition, 2360.
 First Prize, Stucco House, Own Your Home Small House Competition, 2360.
 Kohn, Robert D.:—
 Loft Building, New York, 2368.
 Leone, Amado:—
 Second Prize, Stucco House, Own Your Home Small House Competition, 2360.
 McGoodwin, Robert R.:—
 House at Chestnut Hill, Pa., 2369.
 House of Mr. Norman Ellison, Chestnut Hill, Pa., 2369.
 House of Mr. Spencer Erwin, Chestnut Hill, Pa., 2369.
 House of Mr. Norman Mackie, Chestnut Hill, Pa., 2369.
 House of Mr. Walter Schwartz, Chestnut Hill, Pa., 2369.
 House of Dr. George Woodward, Chestnut Hill, Pa., 2369.
 McIntire, Samuel:—
 Baldwin-Lyman House, Salem, Mass., 2366.
 Cabot-Endicott-Low House, Salem, Mass., 2366.
 Details of Old Salem Houses, Salem, Mass., 2366.
 Jeffrey Lang House, Salem, Mass., 2366.
 Old Ladies' Home, Salem, Mass., 2363.
 Pickering House, Salem, Mass., 2366.
 Pierce-Nichols House, Salem, Mass., 2363.
 Richard-Derby House, Salem, Mass., 2366.
 Stearns House, Salem, Mass., 2366.

ILLUSTRATIONS ACCORDING TO AUTHORS

(Continued)

- McKecknie, John W., & N. Max Dunning:—
House of Mr. Robert J. Thorne, Lake Forest, Ill., 2359.
- McKim, Mead & White:—
Town Hall, New York, 2355.
- Murchison, Kenneth M.:—
Primelles Building, Havana, Cuba, 2365.
- Pennell, H. B.:—
Store Building for Pennell, Gibbs & Quiring Co., Boston, Mass., 2362.
- Pope, John Russell:—
House of Mr. Andrew V. Stout, Redbank, N. J., 2368.
- Randall, James A.:—
Blodgett Vocational High School, Delaware School, Syracuse, N. Y., 2353.
- Rossiter & Muller:—
House of Mr. B. Austin Cheney, New Haven, Conn., 2368.
- Salomonsky, Edgar, and Verna Cook:—
First Prize, Brick House, Own Your Home Small House Competition, 2360.
- Schmidt, Garden & Martin:—
Cosmopolitan State Bank, Chicago, Ill., 2364.
- Sommerfeld & Steckler:—
Gotham National Bank Building, New York, 2361.
- Sutton & Whitney:—
Scottish Rite Cathedral Competition, Portland, Oregon, First Prize Design, 2361.
- Walker & Gillette:—
House of Mr. James J. Hill, Westbury, L. I., N. Y., 2350.
- Warren & Wetmore:—
Ambassador Hotel, New York City, 2370.
- Straus, S. W., & Co. Building, New York City, 2370.
- Welsh, Lewis E.:—
House of Mr. Laurence M. Thompson, Montrose, Pa., 2365.

ILLUSTRATIONS ACCORDING TO SUBJECT

Figures refer to the number of the issue, not to the text pages

- Administrative and Governmental**
- Fire and Police Station for the City of Bridgeport, Conn. Leonard Asheim, Architect, 2369.
- Town Hall, New York City. McKim, Mead & White, Architects, 2355.
- Banks**
- Cosmopolitan State Bank, Chicago, Ill. Richard E. Schmidt, Garden & Martin, Architects, 2364.
- Dixon National Bank Building, Dixon, Ill. N. Max Dunning Architect 2356.
- First National Bank Menasha, Wis. Childs & Smith, Architects, 2351.
- Gotham National Bank Building, New York. Sommerfeld & Steckler, Architects, 2361.
- Guaranty Trust Company, Fifth Avenue, New York City. Cross & Cross, Architects, 2365.
- Industrial Savings Bank Building, Flint, Mich. Davis, McGrath & Kiesling, Architects, 2365.
- Straus, S. W., & Co. Building, New York City. Warren & Wetmore, Architects, 2370.
- Ecclesiastical**
- Bethany Bible School, Chicago. N. Max Dunning, Architect, 2354.
- Mendelson Memorial Chapel, Loudenville, N. Y. Lewis Colt Albro, Architect, 2368.
- Newell Memorial Chapel, Kenosha, Wis. N. Max Dunning, Architect, 2356.
- Scottish Rite Cathedral Competition, Portland Oregon—First Prize Design. Sutton & Whitney, Architects, 2361.
- Educational**
- Blodgett Vocational High School, Syracuse, N. Y. Delaware School, Syracuse, N. Y., James A. Randall, Architect, 2353.
- State Normal School Competition, New Britain, Conn. Guilbert & Betelle, W. F. Brooks, Aymar Embury, II, Architects, 2352.
- Wesley Foundation, University of Illinois, Urbana, Ill. Holabird & Roche, Architects, 2364.
- Frontispieces**
- Cathedral, Wetzlar, Germany, 2350.
- Roman Aqueduct, Tarragona, Italy, 2351.
- Altar, Church of Santa Maria Della Salute, Venice, 2352.
- French Romanesque Doorway, 2353.
- Cathedral, Mainz, Germany, 2354.
- Detail, Gallery Parapet, Church of S. Mark, Venice, 2355.
- Gothic Window, Cathedral, Wetzlar, Germany, 2356.
- Church of S. Maria Della Salute, Venice, 2357.
- Interior, Choir, Sta. Maria Dei Miracoli, Venice, 2358.
- Tomb of Beato Pacifico Buon, Venice, 2359.
- Monuments of Doges, Venice, 2360.
- Detail, Church of St. Maclou, Rouen, France, 2361.
- Cathedral, Wetzlar, Germany, 2362.
- Canal and Bridge of the Miracoli, Venice, 2363.
- Ravenna, Italy, 2364.
- Cloisters, Church of St. Bertrand, Comminges, France, 2365.
- Entrance Detail, Andrew-Safford House, Salem, Mass.
- Detail of Doorway, Rathaus, Lucerne, 2367.
- Church of S. Stephen, Florence, Italy, 2368.
- Detail of a Spanish Church, Circa XV-XVI Century, 2369.
- Basilica of S. Spirito, Ravenna, Italy, 2370.
- Hotels**
- Ambassador Hotel, New York City. Warren & Wetmore, Architects, 2370.
- Menasha Cafe, Menasha, Wis. Childs & Smith, Architects, 2364.
- Hotel Webster, Chicago. Fridstein & Co., Engineers, 2362.
- Industrial**
- American Book Co., Chicago. N. Max Dunning, Architect, 2356.
- Borden Building, New York City. Buchman & Kahn, Architects, 2365.
- Building for Beckley-Ralston Co., Chicago, Ill. Holabird & Roche, Architects, 2364.
- Building for R. T. Ederer Co., Chicago, Ill. Holabird & Roche, Architects, 2364.
- Building for Maxwell Sales Co., Chicago, Ill. Holabird & Roche, Architects, 2364.
- Dixon Home Telephone Co., Dixon, Ill. N. Max Dunning, Architect, 2356.
- Hartford Times Building, Hartford, Conn. Donn Barber, Architect, 2365.
- Loft Building, New York. Robert D. Kohn, Architect, 2368.
- National Cloak & Suit Co., Kansas City, Mo. N. Max Dunning, Architect, 2354.
- Noyes-Buick Building, Boston, Mass. Arthur H. Bowditch, Architect, 2357.
- Office for Simmons Manufacturing Co., Kenosha, Wis. N. Max Dunning, Architect, 2354.
- Stromberg Motor Device Building, Chicago, Ill. N. Max Dunning, Architect, 2356.
- Miscellaneous**
- Architectural League of New York, Thirty-sixth Annual Exhibition, 2365.
- Broadway Theatre, South Boston, Mass. Blackall, Clapp & Whittemore, Architects, 2369.
- Community Building, Flint, Mich. Davis, McGrath & Kiesling, Architects, 2365.
- Details of Old Salem Houses, Salem, Mass. Samuel McIntire, Architect, 2366.
- Kenosha Hospital, Kenosha, Wis. N. Max Dunning, Architect, 2356.
- Old Ladies' Home, Salem, Mass. Samuel McIntire, Architect, 2363.
- Own Your Home Small House Competition, Prize Designs of, 2360.
- Primelles Building, Havana, Cuba. Kenneth M. Murchison, Architect, 2365.
- Riverdale Country Club, Riverdale, N. Y. Dwight James Baum, Architect, 2367.
- Shelter House, Kenosha, Wis. N. Max Dunning, Architect, 2357.
- Store Building for Pennell, Gibbs & Quiring Co., Boston, Mass. H. B. Pennell, Architect, 2362.
- Store of Richard Hudnut, New York. G. A. and H. Boehm, Architects, 2364.
- Residences**
- House at Chestnut Hill, Pa. Robert R. McGoodwin, Architect, 2369.
- House of Mr. Duane Armstrong, Greenwich, Conn. James C. Green, Architect, 2365.
- House of Mr. C. D. Barnes, Kenosha, Wis. N. Max Dunning, Architect, 2359.
- House of Mr. B. Austin Cheney, New Haven, Conn. Rossiter & Muller, Architects, 2368.
- House of Mr. Cyril Crimmins, Noroton, Conn. Raymond M. Hood, Architect, 2359.
- House of Mr. Norman Ellison, Chestnut Hill, Pa. Robert R. McGoodwin, Architect, 2369.
- House of Mr. Spencer Erwin, Chestnut Hill, Pa. Robert R. McGoodwin, Architect, 2369.
- House of Mr. Louis A. Ferguson, Evanston, Ill. Holabird & Roche, Architects, 2363.
- House of Mr. G. S. Gaylord, Neenah, Wis. Childs & Smith, Architects, 2369.
- House of Mr. A. C. Gilbert, Neenah, Wis. Childs & Smith, Architects, 2351.
- House of Mr. John W. Griffin, Fieldston, N. Y. Dwight James Baum, Architect, 2367.
- House of Mr. James J. Hill, Westbury, L. I., N. Y. Walker & Gillette, Architects, 2350.
- House of Mr. Ralph Isham, Santa Barbara, Cal. Childs & Smith, Architects, 2351.
- House of Mr. R. E. Lewis, Hartsdale, N. Y. Dwight James Baum, Architect, 2367.
- House of Mr. Norman Mackie, Chestnut Hill, Pa. Robert R. McGoodwin, Architect, 2369.
- House of Mr. Clarence McDaniel, Hartsdale, N. Y. Julius Gregory, Architect, 2362.
- House of Mr. Chapin S. Pratt, Bronxville, N. Y. Bates & How, Architects, 2365.
- House of Mr. Walter Schwartz, Chestnut Hill, Pa. Robert R. McGoodwin, Architect, 2369.
- House of Mr. M. A. Shea, Fieldston, N. Y. Dwight James Baum, Architect, 2367.
- House of Mr. Mowry Smith, Menasha, Wis. Childs & Smith, Architects, 2364.
- House of Mr. Andrew V. Stout, Redbank, N. J. John Russell Pope, Architect, 2368.
- House of Mr. Laurence M. Thompson, Montrose, Pa. Lewis E. Welsh, Architect, 2365.
- House of Mr. Robert J. Thorne, Lake Forest, Ill. John W. McKecknie, Architect; N. Max Dunning, Associate Architect, 2359.
- House of Mr. Joseph E. Tilt, Chicago. Holabird & Roche, Architects, 2363.
- House of Mr. F. C. Traver, Kenilworth, Ill. N. Max Dunning, Architect, 2354.
- House of Mr. Robert E. Ward, Wilmette, Ill. N. Max Dunning, Architect, 2354.
- House of Dr. George Woodward, Chestnut Hill, Pa. Robert R. McGoodwin, Architect, 2369.
- House of Mr. E. I. Woodworth, Passaic, N. J. John F. Jackson, Architect, 2364.
- House of Mr. Herman Younker, Elmsford, N. Y. Buchman & Kahn, Architects, 2365.
- Baldwin-Lyman House, Salem, Mass. Samuel McIntire, Architect, 2366.
- Cabot-Endicott-Low House, Salem, Mass. Samuel McIntire, Architect, 2366.
- Jeffrey Lang House, Salem, Mass. Samuel McIntire, Architect, 2366.
- Pickering House, Salem, Mass., Samuel McIntire, Architect, 2366.
- Pierce-Nichols House, Salem, Mass. Samuel McIntire, Architect, 2363.
- Richard-Derby House, Salem, Mass. Samuel McIntire, Architect, 2366.
- Stearns House, Salem, Mass. Samuel McIntire, Architect, 2366.

ILLUSTRATIONS ACCORDING TO LOCATION

Figures refer to the number of the issue, not to the text pages

California—

Santa Barbara:—
House of Mr. Ralph Isham. Childs & Smith, Architects, 2351.

Connecticut—

Bridgeport:—
Fire and Police Station. Leonard Asheim, Architect, 2369.

Greenwich:—
House of Mr. Duane Armstrong. James C. Green, Architect, 2365.

Hartford:—
Hartford Times Building. Donn Barber, Architect, 2365.

New Britain:—
State Normal School Competition. Guilbert & Betelle, W. F. Brooks, Aymar Embury, II, Architects, 2352.

New Haven:—
House of Mr. B. Austin Cheney. Rossiter & Muller, Architects, 2368.

Noroton:—
House of Mr. Cyril Crimmins. Raymond M. Hood, Architect, 2359.

Cuba—

Havana:—
Primerles Building. Kenneth M. Murchison, Architect, 2365.

Illinois—

Chicago:—
American Book Co. N. Max Dunning, Architect, 2356.

Bethany Bible School. N. Max Dunning, Architect, 2354.

Building for Beckley-Ralston Co. Holabird & Roche, Architects, 2364.

Building for R. T. Ederer Co. Holabird & Roche, Architects, 2364.

Building for Maxwell Sales Co. Holabird & Roche, Architects, 2364.

Cosmopolitan State Bank. Richard E. Schmidt, Garden & Martin, Architects, 2364.

Hotel Webster. Fridstein & Co., Engineers, 2362.

House of Mr. Joseph E. Tilt. Holabird & Roche, Architects, 2363.

Dixon:—
Dixon National Bank Building. N. Max Dunning, Architect, 2356.

Dixon Telephone Co. N. Max Dunning, Architect, 2356.

Evanson:—
House of Mr. Louis A. Ferguson. Holabird & Roche, Architects, 2363.

Kenilworth:—
House of Mr. F. C. Traver. N. Max Dunning, Architect, 2354.

Lake Forest:—
House of Robert J. Thorpe, John W. McKecknie, Architect; N. Max Dunning, Associate Architect, 2359.

Urbana:—
Wesley Foundation, University of Illinois. Holabird & Roche, Architects, 2364.

Wilmette:—
House of Mr. Robert E. Ward. N. Max Dunning, Architect, 2354.

Massachusetts—

Boston:—
Noyes-Buick Building. Arthur H. Bowditch, Architect, 2357.

Store Building for Pennell, Gibbs & Quiring Co. H. B. Pennell, Architect, 2362.

Boston, South:—
Broadway Theatre. Blackall, Clapp & Whittemore, Architects, 2369.

Salem:—
Baldwin-Lyman House. Samuel McIntire, Architect, 2366.

Cabot-Endicott-Low House. Samuel McIntire, Architect, 2366.

Details of Old Salem Houses. Samuel McIntire, Architect, 2366.

Jeffrey Lang House. Samuel McIntire, Architect, 2366.

Old Ladies' Home. Samuel McIntire, Architect, 2363.

Pickering House. Samuel McIntire, Architect, 2366.

Pierce-Nichols House. Samuel McIntire, Architect, 2363.

Richard-Derby House. Samuel McIntire, Architect, 2366.

Stearns House. Samuel McIntire, Architect, 2366.

Michigan—

Flint:—
Community Building. Davis, McGrath & Kiesling, Architects, 2365.

Industrial Savings Bank Building. Davis, McGrath & Kiesling, Architects, 2365.

Missouri—

Kansas City:—
National Cloak & Suit Co. N. Max Dunning, Architect, 2354.

New Jersey—

Passaic:—
House of Mr. E. I. Woodworth. John F. Jackson, Architect, 2364.

Redbank:—
House of Mr. Andrew V. Stout. John Russell Pope, Architect, 2368.

New York—

Bronxville:—
House of Mr. Chapin S. Pratt. Bates & How, Architects, 2365.

Elmsford:—
House of Mr. Herman Younker. Buchman & Kahn, Architect, 2365.

Fieldston:—
House of Mr. John W. Griffin. Dwight James Baum, Architect, 2367.

Hartsdale:—
House of Mr. R. E. Lewis. Dwight James Baum, Architect, 2367.

House of Mr. Clarence McDaniel. Julius Gregory, Architect, 2362.

Loudenville:—
Mendelson Memorial Chapel. Lewis Colt Althro, Architect, 2368.

New York:—

Ambassador Hotel. Warren & Wetmore, Architects, 2370.

Borden Building. Buchman & Kahn, Architect, 2365.

Gotham National Bank Building. Sommerfeld & Steckler, Architects, 2361.

Guaranty Trust Company, Fifth Avenue. Cross & Cross, Architects, 2365.

Loft Building. Robert D. Kohn, Architect, 2368.

Store of Richard Hudnut. G. A. and H. Boehm, Architects, 2364.

Straus, S. W., & Co. Building. Warren & Wetmore, Architects, 2370.

Town Hall. McKim, Mead & White, Architects, 2355.

Riverdale:—
Riverdale Country Club. Dwight James Baum, Architect, 2367.

Syracuse:—
Blodgett Vocational School, Delaware School. James A. Randall, Architect, 2353.

Westbury, L. I.:—
House of Mr. James J. Hill. Walker & Gillette, Architects, 2350.

Oregon—

Portland:—
Scottish Rite Cathedral Competition—
First Prize Design. Sutton & Whitney, Architects, 2361.

Pennsylvania—

Chestnut Hill:—
House at Chestnut Hill, Pa. Robert R. McGoodwin, Architect, 2369.

House of Mr. Norman Ellison. Robert R. McGoodwin, Architect, 2369.

House of Mr. Spencer Erwin. Robert R. McGoodwin, Architect, 2369.

House of Mr. Norman Mackie. Robert R. McGoodwin, Architect, 2369.

House of Mr. Walter Schwartz. Robert R. McGoodwin, Architect, 2369.

House of Dr. George Woodward. Robert R. McGoodwin, Architect, 2369.

Montrose:—
House of Mr. Laurence M. Thompson. Lewis E. Welsh, Architect, 2365.

Wisconsin—

Kenosha:—
House of Mr. C. D. Barnes. N. Max Dunning, Architect, 2359.

Kenosha Hospital. N. Max Dunning, Architect, 2356.

Newell Memorial Chapel. N. Max Dunning, Architect, 2356.

Office for Simmons Mfg. Co. N. Max Dunning, Architect, 2354.

Menasha:—
First National Bank. Childs & Smith, Architects, 2351.

House of Mr. Mowry Smith. Childs & Smith, Architects, 2364.

Menasha Cafe. Childs & Smith, Architects, 2364.

Neenah:—
House of Mr. G. S. Gaylord. Childs & Smith, Architects, 2369.

House of Mr. A. C. Gilbert. Childs & Smith, Architects, 2351.

States listed as follows:—
194^a 16^b, 2^a 44^b, 28^a 70^b, 42^a 94^b, 120^a 120^b, 140^a, 50^a 114^b = 176^a,
194^a 206^b, 206^a 244^b, 174^a 364^b, 394^a 398^b, 426^a 428^b, 452^a,
452^a 488^b, 488^a 490^b, 514^a 522^b, 534^a 536^b, 584^a 586^b, 612^a,
116^a 16^b, 648^a 650^b,
(These undeclared are in inches).

The American Architect Specification Manual for 1921

THE American Architect *Specification Manual*, edition of 1921, is now being prepared and will be ready for distribution about August 1st.

We publish this volume as a service rendered to the profession which supports our publication, and copies of the *Manual* will be supplied (until the stock is distributed) free of charge to all practicing architects sending us requests on their office stationery. Many requests for the 1921 edition have already reached us, and we suggest that promptness in forwarding these requests is desirable in order to secure a volume before the stock is exhausted.

We take this opportunity to express appreciation of the cordial welcome given previous editions of the *Manual*. These were supplied to more than 3,000 architects in America, and have proved of practical value in the preparation of specifications, as evidenced by hundreds of letters received by us from architectural offices heartily commending the work.

The 1921 edition will be of greater size and importance than its predecessors, and will contain more than 170 specifications of standard building materials and processes. These specifications embody in condensed language the result of many years of experience of hundreds of experts in the use of the materials and methods specified.

Mr. Gardner C. Coughlen, Executive Secretary of the American Specification Institute, is acting as editor of the 1921 *Manual*. This is an indication of the quality of the form of the specification material.



The American Architect

fish to piece to No 2350



THE CATHEDRAL, WETZLAR, GERMANY

THE AMERICAN ARCHITECT

VOL. CXIX

WEDNESDAY, JANUARY 5, 1921

NUMBER 2350

The Practice of Architecture in 1921

The Future as Viewed by C. H. Blackall, F. A. I. A.

IN THE AMERICAN ARCHITECT of June 5, 1918, when the hopes of the great war were at their lowest ebb, the writer ventured to make certain predictions as to what architecture would be after the war. So far not one of those predictions has come true. The much anticipated revival of business has not taken place. There have been sporadic developments, and a few of the favored ones have been very busy, but building as a whole has not flourished since the war in any general locality, and if we may make some rough approximations from general statistics, there are not as many architects in practice today as there were in 1918, and the amount of work available is very much less. It would be very easy, and perhaps quite natural, to deduce from this that the prospects are altogether disappointing, that the hopes we had cherished in the time of our stress were not justified and that the future is no more clear now that it was then. Now what is the answer?

The eclipse which the profession suffered during the war has fairly passed away. In fact, even during the latter years of the war some of the most important war work was entrusted to members of our profession, not merely the housing, which after all was simply a pot-boiler, but the more serious engineering works which assumed the magnitude of monuments; and we are as a profession in a better shape to handle our work because of the experiences which we had, and especially because of the chastening indifference which the public and the authorities evinced for several years to our high professional claims. As I see it, the profession is more nearly on a business basis than ever before. The discussions which took place in the last convention of the American Institute of Architects were on the whole so eminently practical and so free from mere professionalism that they showed how we have been forced to look at our calling, and there has been such a wide-spread interest in the business and the so-called practical side of architecture that there must be something behind it more than the mere desire of the members of the profession to get work. In fact, one of the character-

istics of the attitude of the profession has been that it ought not to try to get work. Perhaps it would have been better if we had tried more earnestly and more intelligently; perhaps we would have more work and more public esteem if we were more ready to take part in the constant fight for recognition; perhaps we would stand higher if we were not so retiring. Surely when so much emphasis is placed on the manner of doing and getting our work, and on the necessity of doing our work right from the business and scientific as well as the imaginative side, it is pretty good evidence that the profession has cast away a very considerable proportion of the purely professional attitude which so hampered it during the war.

From the standpoint of carrying out our work, there is every reason to anticipate conditions will constantly improve in the next few months. Also in our offices conditions will improve. Few of the young men who entered the service of the government during the war came out of it with credit. They shared in the general let-down which affected all classes and conditions, not excepting the architects themselves, and we were forced to put up with indifferent co-operation and inefficient assistance. That is changing fast, and by spring we will have a better choice of help and more hearty co-operation than we have had for six years. That will mean better architecture, better satisfaction to our clients and a better feeling on all sides. As to what part of the work will come to us in the future, opinions may vary, but there are a number of cases which have been noted where the architect has resumed not only his past importance as a director of work, but where he has been looked to in a degree which would have been impossible before the days of the war. In one city the writer knows of a large project involving tens of millions which a few years ago would have come to the architect only after all the preliminaries were decided, but in this case the architects were called in first and were able to assist at the very beginning of the whole conception. This is only one of the many instances which are on record.

THE AMERICAN ARCHITECT

As to how much work the architects will have, it is my belief that those who have had in the past and have shown their ability will have a great deal more; that as a result of the stress of the war period, the public will be more cautious about accepting an architect simply because he is a good fellow, or well connected, and that the profession will see more than ever before the rise of the architect, or architectural organization, controlling many millions of work, and the subordination of the men of limited experience and ability to the smaller work. This is inevitable and will mean better architecture, better execution, and in the long run better professional feeling. One architectural combination is reported as having work running up to seventy-five millions of dollars. It is a fair probability that this concern with seventy millions of work will do it better, more thoroughly, more efficiently and more economically than would have been possible at any time before the war for an architect, or group of architects, to do one-tenth part of that work. The war lessons have not all been hard. Some of them we have been able to take very much to heart, and the most valuable, as I see it, is the need of

association, the impossibility of one man doing it all, and the inevitableness of the concentration of large work in the hands of the few who are best fitted for it. This may seem like restricting the hopes of the young men. On the contrary, it greatly increases the horizon for every young man who will take the pains to fit himself properly for his profession, for the opportunities of the profession are not measured by the average chance, but by the higher prizes; and with the country suffering as it does now from underbuilding in every line, with the vast accumulation of wealth in the hands of banks, trustees, insurance companies and the like, which will be readily available for legitimate building operations, I look to see a revival of building such as the world has never seen before, when we will have opportunities measured only by our capabilities, when those who are able to take, will have both hands full. But we must not, and we cannot, forget the lessons of the war, nor ignore the extent to which we must live up to the best of our profession and must treat our calling as a very exacting business, a very definite science and the highest art which man can make manifest in this world.

The Relationship between Architecture and Building

The Present Conditions and Future Prosperity of the Building Industry

By LOUIS JAY HOROWITZ, President, Thompson-Starrett Co.

THE Editor of THE AMERICAN ARCHITECT asked me to express in this article my views as to the relationship between architect and builder, and the present condition and future prospects of the building industry. One may, at best, offer only a surmise as to what is in store for the industry in the near future, but of the absolute need of co-operation between Architect and Builder in every operation, I may be allowed to speak with sympathy and conviction.

I am unalterably opposed to the methods of some contractors who seek to dispense with the architect and who attempt to embrace in their activities both the design of a building and its execution. I am opposed to it, not from any sentimental reason for the architect, but from purely business reasons for the owner. The designing and planning of buildings is in itself a special and separate study, and the contractor who treats it as just one more addition to the great variety of his labors is not only slighting the

architect's profession, but disparaging architecture itself, and needs to be reminded (loth as I am to admit it!) that architects are remembered when builders are forgotten. Sir Christopher Wren designed St. Paul's Cathedral, but who built it? However, the architect's case does not rest on tradition alone, but on efficiency. His is a career of true specialization, and with the constantly rising cost of space in modern cities, it is sheer folly to underestimate the services of one who devotes his talents to utilizing it to the best advantage.

Obversely, I may be permitted the privilege of saying, that the contractor cannot wisely be dispensed with by the architect. Indeed, this must be so, or the other side of the argument falls to the ground. A properly-conducted building operation demands the services of both architect and contractor, and, for either to dismiss the services of the other as superfluous, is to create a situation inherently unsound and unsafe. I will not assume to define the

THE AMERICAN ARCHITECT

limits of the architect's work, but I violate no confidence when I say, that the contractor's end of the proposition, if skillfully and conscientiously handled, will provide his organization with all it can do. In these days of collusive bidding, complex transportation problems, high wages, shortage of skilled mechanics, and other economic difficulties, a contractor has enough to do to cope with his own tasks without assuming those for which he is not fitted. It is deplorable that many contractors fail either to appreciate the gravity of these problems or to overcome them, and certainly any attempt to enlarge upon their difficulties by adding architecture to the list, may be set down as due to an excess of zeal for their own interests at the expense of the client.

Still another advantage in having an architect is that he is equipped to supervise and check the work of the contractors, and to see that promises of speed and economy are kept without sacrificing the specifications. Having no financial interest in the building beyond his fee, he is detached and impartial, can be depended upon to see that justice is done to his client, and is ideally situated to act in an advisory and supervisory capacity. Obviously, when an architect takes the contractor's place, too, he loses much of that detachment and impartiality, for however zealous his dual labors as both architect and contractor his zeal can hardly be expected to include criticism of his own work! And in any event his fee is inadequate to maintain a great organization on his payroll, and without such an organization the work is bound to suffer in efficiency and to expand in cost.

Coming to the second part of my assignment, the present condition of the building industry is obviously due to three changes:

1. Universal business depression.
2. Inability in many instances to finance building prospects.
3. Disposition of owners to wait for stabilizing of material and labor costs.

The present depression is, of course, one of the aftermaths of the great conflict, and no man can say just how long it will continue. One may only hazard a guess, and risk the prophecy. But it is my personal opinion that most of the drastic processes of post-war readjustment should be over in the early part of 1921 and that we may reasonably look for a gradual recrudescence of confidence from that time on. It may be argued that the present chaos in Wall street—which is the barometer of economic cycles—hardly justifies a spirit of optimism at this time. But my own conviction is, that that is just what it does justify. The great consolation in having things so bad that they cannot be worse, is that they have got to get better. It is blackest before the dawn, and swift as have been the disillusionments of recent months, the restoration of confidence will be swifter still when it starts, for the world reacts to prosperity as its rightful heritage, but has no use for trouble. With a return of confidence money will be easier, building loans more readily available, and to employ Webster's famous figure (though times are not so bad as when he used it) "The corpse of public credit will spring to its feet."

As for building costs, I do not look for any reduction in the scale of wages; but inasmuch as labor is much more efficient today than it has been for several years past, higher wages will be absorbed by more skillful and competent workmanship. Neither do I look for any substantial reduction in the cost of building materials, though it is sure to take place in such lines as have been unduly susceptible to inflation. But I believe that many materials, such as lumber, for example, are selling well below production cost at this time on account of forced liquidation to raise cash. There is, in other words, no serious obstacle beyond the cited shortage of confidence and credit to prevent much longer a period of great building activity to take care of requirements whose figures are estimated at five billions of dollars.



The Relationship between the Architect and the Engineer

An Interview with Kort Berle, M. Am.Soc. C. E., of the Firm of Gunvald Aus Company, Consulting Engineers, New York City

AFTER a very full and free discussion with Mr. Berle of the relationship between the architect and engineer as it exists and as it should be one could not avoid carrying away the impression that if the feeling of admiration and esteem and the attitude of helpful co-operation which exists between this engineering firm and some of its clients could prevail throughout the two professions there would be no need of any discussion of this much debated subject. But Mr. Berle feels that ideal relationship does not generally exist, and for this condition he believes the architects themselves are largely to blame.

"What, in your opinion," we asked Mr. Berle, "could and should be done to improve present conditions?" His answer was readily forthcoming.

"Simply a recognition on the part of architects of the highly professional nature of engineering which makes possible the erection of structures which arouse the awe of our European visitors. The architect frequently views the structural engineer as no more than a draftsman capable only of pushing a slide rule in figuring the size of beams and getting out structural drawings. In this conception he is entirely at fault. The ability to compute loads and stresses and set forth the results by drawings is indeed a necessary attribute for the engineer engaged in building construction, but engineering is much more than this, as any architect of important structures will realize. The failure on the part of architects to recognize and properly evaluate the services of the engineer, and to accord him a place as an associate, tends to place the engineer in a position so subordinate that it is unfair. How often, even on buildings of great magnitude, is the name of the engineer mentioned? In the presentation of work in the architectural press, the engineer's name is almost invariably conspicuous by its absence. Surely the mention of the man upon whose work the stability of the structure depends would in no way detract from the credit accruing to the architect. Architects decry the practice of the daily press in so often omitting any mention of the architect's name, yet in their own press they very often deny the engineer the same recognition for which they—however justly—criticise others.

"I have often talked over this matter with prominent architects, and they feel that my attitude on this

subject is absolutely correct, and that in order to foster a greater co-operation and a more friendly feeling between these brother professions, the architect must recognize the engineer as a fellow professional man, and not merely as a subordinate.

"I do not wish in any way to depreciate the splendid work of the architects, and am greatly gratified to see a constant improvement in building design."

Mr. Berle then led the writer around the office, pointing out pictures of various structures ranging from the humble warehouse to the lofty Woolworth Tower, and called my attention to their excellent architectural treatment, over which he waxed so enthusiastic that one would have thought him an artist rather than the keen, calculating engineer that he is. Probably his former connection as Chief Engineer of the Supervising Architect's office in Washington and his many years of close contact with some of our foremost architects, have much to do with his high appreciation of art in architecture.

Since in several recent instances structural engineers have been commissioned by the owners to handle the entire work—both architectural and engineering—we questioned Mr. Berle as to his views on such practices. We found him absolutely convinced that such an arrangement was all wrong. To the arrangement by which the engineer became associated with an architectural organization as a member of the firm, he saw no particular objection and felt that such combinations led to a better understanding between the members of both professions, while at the same time placing them on an absolutely equal footing as professional men. However, except where the volume of business handled by an architectural organization was very large, he expressed doubt as to the possibility of the engineer member of the firm keeping busy all the time on engineering work. "Some few architects," said Mr. Berle, "have their structural work performed in their own office by the employment of an engineer and assistants on a salary basis. It should be self-evident that such an arrangement cannot properly fulfill requirements. For it is safe to say that no engineer of ability and high standing in his profession would be satisfied to hold so subordinate a position and which, necessarily, would be very limited as to compensation and advancement as well as to scope of work."

"In my opinion," said Mr. Berle, "the best inter-

THE AMERICAN ARCHITECT

ests are served by the architect calling to his assistance a consulting engineer of the highest reputation and one in whom he can place absolute confidence. He should call upon him to co-operate in the work from its earliest preliminary stages. By such an arrangement the architect can secure the very highest type of engineering service and he is obliged to pay only for the work performed."

The importance of this close co-operation during all stages of the work, and of the architect immediately calling to the attention of the engineer any changes, he illustrated by mentioning an instance in which on a certain piece of work a 20 in. by 80 lb. I-beam was to span an entrance opening. Due to a change in the façade requiring a shallower beam, the size specified was replaced by two 12 in. by 40 lb. I-beams without the engineer's knowledge. The result was unfortunate in that the excess deflection of the beams caused very serious cracks in the stone façade. In this case $2 + 2$ did not equal 4.

WE next discussed bridges and the desirability of architectural treatment on such structures. Here we found Mr. Berle placed the highest importance upon architectural co-operation. He pointed to the Hell Gate bridge as a most excellent example. But in such work he felt the order should be revised—that while in building design the architect should be the guiding head. "We must have a head to everything, you know," he said—and the engineer his co-operating associate, in the case of bridges the engineer should be the directing head, and the architect the co-operating associate. "I would be the last to depreciate the value of aesthetically designed structures, and certainly, beauty of line should be an object sought for in the design of any bridge." In the matter of bridge approaches, he felt the architect could render and has already rendered most valuable service.

He denounced the practice of some architects who seek to obtain "free" engineering services from contracting firms, such as the design of their structural work. "While this service is free to the architect," stated Mr. Berle, "it costs money to some one, and although it may be indirectly charged, the owner ultimately has to pay for it. It is just as much a violation of a proper ethical code to obtain so-called free engineering service as to endeavor to have the contractor furnish free architectural service. Both are practised, but neither is conducive to the best interests of either the owner or the two professions, and no architect can in the long run continue such methods and retain either his self-respect or his professional reputation."

Another point Mr. Berle made was the discrimination between the structural and mechanical engineer by the code of the Institute. It is here stated that the mechanical engineer should be paid a fee (on the value of all mechanical equipment) by the owner, whereas no such distinction is made in the case of the structural engineer, who must conduct his own negotiations with the architect as to the amount of his fee, which the architect must pay out of his own often-too-meager compensation.

"Why not at least put both structural and mechanical engineer in the same class?" he queried. "In justice both to the architect and the structural engineer, the Institute code should again be revised, so that *all* engineering services be paid for by the owner. This would perhaps, more than anything else, tend to make the relationship between the two professions more nearly what it should be."

In closing, Mr. Berle expressed his belief that a closer co-operation was already more evident and that the engineering profession welcomed it. The future hinges entirely on a better understanding.



The Financial Outlook

By FRANCIS H. SISSON, *Vice-President, Guaranty Trust Company of New York.*

WITH economic conditions in this country fundamentally sound, the great need of the hour, as we turn from retrospection to face the prospects of the New Year, is constructive thinking. If faith alone has moved mountains, surely faith plus brain power can put the world on a new and stable peace basis.

We are richly endowed with all the assets for our full participation in that task and the wonderful future that lies ahead of us when the task shall have been completed—but we seem to lack faith. As we stand on the threshold of the New Year and of the door to the greatest opportunities ever opened to any nation in all history, we hesitate and doubt. Like those who cannot see the forest for the trees, we are too prone to exaggerate our liabilities and not only belittle but even ignore our vast resources.

Leadership that will direct our national thought into logical channels and more in accord with our manifest destiny is imperatively demanded as we enter 1921. And it is the duty of the Government, especially Congress, to assume that leadership.

Congress has never faced more important problems than those which confront it today. It is faced with the necessity of not only enacting constructive legislation but also of repealing obstructive laws.

While many changes should be made in our existing tax law in the interest of business progress, the first and most important step in tax revision should be the repeal of the Excess Profits tax. This tax may have been justified as a war measure, but it clearly has no place in peace-time legislation, and few, if any, tenable arguments can be advanced in favor of its retention. On the other hand, the arguments offered against it have become so familiar that it is useless to discuss them. Let it suffice to say that the inequalities resulting from its application are so great as to condemn it absolutely and fully justify its repeal at the earliest possible moment.

Although the adoption of a budget system and the introduction of a more economical system of administering the Government will materially reduce the aggregate amount of revenue required for the support of the Government, it seems likely that the rapid fall of prices which we are now experiencing and the existing depression in business will adversely affect the amount of revenue to be derived from income taxes. It will, therefore, be incumbent upon Congress to adopt a new method of taxation which will serve to make up the deficit resulting from the repeal of the Excess Profits tax.

SOME form of sales tax at a low rate seems to offer the least objectionable substitute for the Excess Profits tax, since it would be most produc-

tive and would be so widely distributed that it would not prove unduly burdensome. Such taxes will not have the tendency to encourage extravagance and penalize business efficiency, as is the case with the Excess Profits tax, and, on the other hand, from the standpoint of the Government, will not be subject to great fluctuation in periods of business depression and may be easily administered. Sales taxes can no longer be regarded as experiments, if we can rely upon the reports of the success of these taxes in Canada, the Philippines, and France, and to a limited degree in several other countries.

The great burden of war taxation has brought home to business men with added force the need of adopting as a permanent part of our machinery of Government, a well-organized budget system which will result in the placing of the financial operations of the Government on a scientific basis, thereby helping to eliminate waste and extravagance. Legislation, to this end, should be first considered by Congress.

Of equal importance, as compared with the problem of taxation, is the state of our international relations and their effect on our present and future foreign trade. In spite of the fact that more than two years have elapsed since the signing of the armistice, we are still, theoretically at least, in a state of war with Germany and her allies. No doubt exists as to the necessity for the establishment, at the earliest possible moment, of a state of peace with these countries and the strengthening of international economic relations with the whole world. While it seems probable that the present period of industrial depression is but a temporary one and that it is only a question of time before our industries will be functioning as usual, it is quite evident that our future prosperity is largely dependent upon our international trade.

Valuable service can be rendered through the enlarging of the Government's facilities for obtaining prompt and accurate information in regard to conditions existing in foreign countries which will affect our foreign trade, and the prompt distribution of this information to business concerns who can use it.

Of equal importance with the enactment of legislation necessary to placing the Government on a sound business, is efficient administration of existing laws.

Basically, as I have stated, economic conditions in the United States are absolutely sound, and what is chiefly needed to preserve our prosperity is just common-sense, constructive co-operation between Congress and the progressive business interests of the country.

The Real Estate Outlook for 1921

A Forecast for the Year by One of the Country's Most Prominent Real Estate Operators, Who Believes Architects to Be So Important in Our Complex Scheme of Civilization that They "Can Either Make or Break Real Estate Values"

By JOSEPH P. DAY

REAL estate, not only in New York City and the so-called Metropolitan Zone, but also throughout the entire country, has had a wonderful period of prosperity during the past year, and the outlook is for continued activity during 1921. The scarcity of buildings of all kinds has had the effect of increasing valuations and also has brought this greatest form of investment into stronger hands than ever before in the history of the country.

In the first place there has been and is to-day a distinct shortage of places of residence. The war brought on a recession of building of this class of structure, except in certain industrial centres where houses were erected to accommodate the war worker. Private operations came practically to a standstill and the high prices precluded the possibility of speculative builders erecting houses for the open market.

Builders, however, went into the field of constructing war plants and large industrial buildings to meet what was then the most pressing demand, with the result that apartments and dwellings were neglected. This had the effect of increasing values, because the demand far exceeded the supply. Those operators and speculators who owned multi-family houses were obliged to raise rents in order to meet the increased cost of operation, but, unfortunately, there were some who took advantage of the situation to increase rentals beyond reason. This caused the passage of certain restrictive legislation in New York State and in some other states throughout the country, though these laws have a time limit, when it is hoped that the supply will be more nearly equal to the demand than to-day.

Students of real estate conditions throughout the country are all of the opinion that we are working into a period of construction. This will be commenced just as soon as the building material prices recede to a sufficiently low level and when labor becomes more plentiful. The trend at the present time is toward lower prices and freer labor conditions, and unless something unforeseen occurs the building move should begin within the next few months. Once building starts the market will assume a more healthy tone.

At the present time there is no particular shortage of industrial buildings, because many of the war-time plants have been built to a far larger than peace-time requirements, but this additional space will soon be absorbed by other concerns which will devote their energies toward making products precluded by war needs.

At the present time the financial interests are concerned with general business conditions, and they are only willing to make commitments where necessity is shown. The country, however, is so big and it has such recuperative powers that the money market should soon be readjusted and normal conditions again obtain.

"Booms" in real estate are not desirable. Of course money is made, but there is always a "throw-back" which interferes with the normal conduct of business and in the end hampers real progress. In the case of vacant lots, I look to see a forward movement, which will last for some time to come. When the builders again enter the field thousands and thousands of vacant lots will be absorbed, with the result that not only the actual land improved will enhance in value, but the effect will be felt by the property in the vicinity.

So far as realty in the cities is concerned, those sections which are served with transit lines will be the first to feel the benefits, and then later those more remote will come in for their proportionate share. This is of course logical, and I believe that history will repeat itself. In suburban sections, not served with real transit, those tracts which are accessible by good roads will be developed first and then the outlying sections will be marketed.

AVAST number of people have made money during the war, and I look to see an active market for country estates in all sections of the country, within reasonable distances from the city. The automobile has, of course, been a great factor in bringing these properties into the market and has made them available for this purpose, where heretofore farming was the only use to which they could be put.

THE AMERICAN ARCHITECT

I look to see the auction market in vacant lots more active than ever before. There are many reasons why this should be the case. Let us say that a large tract of land is under one ownership and is located near transit and within a reasonable distance from a city. The owner, to sell this property at private treaty, must have a large selling force, do a great deal of advertising over a long period, and go through a large amount of trouble and annoyance before he finally gets rid of his holding.

The auction market provides a means whereby he can dispose of all his property at one time, through one advertising campaign, assuming, of course, he engages an auctioneer with a sufficiently large and well equipped organization to handle his property. On the day set his property is offered and sold and then he is relieved from further responsibility. Naturally his property must have merit and the sale must be held at a time when there is a demand for that particular class of property, but my experience is that in a properly conducted campaign of education the advantages of buying at auction can be shown to those residing in the community and the result should be that the seller gets a fair price for his property and the buyer obtains a plot which will meet his requirements.

The selling of property at auction takes it out of one ownership and places it in the hands of many. This means enhancement, because it is frequently

the case that where a property is long and closely held it acts as a detriment to the neighborhood, rather than an advantage.

The country is so large and the interests of the inhabitants are so varied that it is hard to lay down any fast and set rules which will apply universally. One thing is certain, however. Real estate is the finest investment in the world. The man who owns realty is his own "Board of Directors" and he has no one to account to, except the municipality. So long as he obeys the laws on the statute books he has nothing to fear, and it is only right that this should be so. If in certain sections there are unjust laws, they can be repealed and should be repealed. It is simply up to the citizens of that locality.

There are three essentials to life here on earth. The first is food, the second is clothing and the third is housing. So long as there are humans on this globe these three must be provided. So far as the third named is concerned the architect plays a most important part. He is a specialist. It is up to him to see that proper houses of all types are designed. He can either make or break real estate values. Too much importance cannot be placed on this phase of the situation. I hope that architectural schools and colleges will be encouraged and that the standard of the profession will always be kept on the present high level.

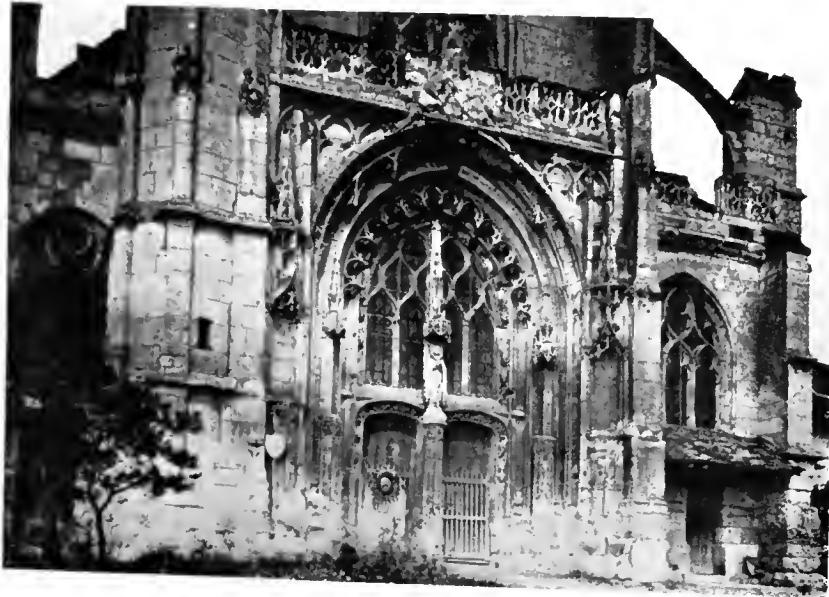

Good Workmanship the True Craftsmanship

Craftsmanship as Viewed by a Man Who Believes That the Designer of Anything Should Be as Familiar with the Best Designing That Has Been Done in the Past as He Is with His Own Collar Button, and That the Designer of Anything at All Should Be a Profound Student Before He Is Allowed Any Freedom as a Craftsman

By "TRAVI," Craftsman

IN this iconoclastic age when little is held sacred and nearly everything prostituted, words are also taken liberties with, usually through ignorance, until they through common misuse lose their original meaning. As craftsmen now are makers of pantaloons and "artists" shavers of men's faces, it is rather foolish and misleading to use either of these words in connection with this very much in earnest work. Craftsmanship is just Good Workmanship, judged from the standpoint of an earlier and more capable period when workmen's ideals were higher and their work as much a matter of religion as their church; when their interest had more to do with the excellence of their handicraft and was not entirely devoted to the clock and the pay envelope.

It is work done as conscientiously, as carefully finished and in the same reverential spirit as the work done in the past. Consequently it is of no commercial value and of little interest to anybody—from a factory standpoint—as it takes too long to do and is too costly. It is done more or less in the spirit of the work done in the seventeenth century and earlier, with a striving after the directness and simplicity of methods which are necessarily brought about by working entirely by hand and "feeling" and dispensing with any mechanical shortcuts to results.

Doing this usually necessitates the going back to simple, fundamental types of tools (many of which the modern workman has forgotten the use of and does not even know the names of) and which are better suited for fashioning the different materials to be used, and to bring about results as near as possible to those achieved when the workman knew of little or no machinery and scorned to use it if he did.

In the past, during the periods when the most beautiful work was done, the tools used were very few. Now there has never in the history of the world been so many tools or such an infinite variety of them, and of machinery, and yet our world is all "messed up" with cheap and inferior performances done with both, with the exception of course of tools of precision for scientific purposes and instruments

of accuracy. All of which would very likely better fulfill their missions if they were of better design.

THE primitive (for want of a better word) in man, or his human side, seems never satisfied with the things he handles in everyday life, as they have little appeal to his imagination. A man always likes a tool which he thinks he could have made himself, and sooner or later he usually tries and does do so. Man is a creative animal and to be happy must use his hands to fashion things with.

So it seems that the obvious thing lacking in modern workmanship is the human note—a slight blemish on a thing or an irregularity gives it more individuality and human interest, than something turned out "standardized," "inspected," "O. K'd" and what not. Another deplorable thing is the lack of sense of proportion generally and the small attention paid to design. Most things in the arts, crafts, industries and textiles are poorly designed, not well or strongly made. But finished to the last degree. Always *finish* with no merit beneath the skin. So everything is more or less covered with glitter of some kind—varnish, plating or dressing—"dolled up" in some way, to catch the eye of ignorance. It is a Jerry-built world we are living in at present and man's performance with his hands, of every kind, make a sorry showing and are very inferior to the best which has been done in art, architecture and workmanship of the past.

To go back to our work-bench:

All the work is done, in whatever material, whether it is mural painting or miniature, sculpture or etching in metal or glass, enamelling metal, inlaying amethyst in lead, carving alabaster or jade, ivory, carved wood or brick, parquetry, intarsia, sgraffito, scagliola, building buttressed stone walls, forging iron work, plaster work, brass, adzing wooden timber and inlaying them with lead and bone and harder and more precious woods, or mosaic or tiling, all of it and any of it is done with practically the same tools and with a selection from not more than twenty

THE AMERICAN ARCHITECT

types. The material is of only incidental interest. It is the beauty and character of the design and true feeling of it, and the "tooling" of the material that is the essence. It is equally possible to put this feeling in any of the materials mentioned above.

Modern jewelry, for instance, is designed more like left-over designs for Victorian ice pitchers than like beautiful trinkets. The spirit of jewelry is not there and only the value of the material is considered. In other words, that part of the mind which "cash registers" is pleased and not the eye or the aesthetic sense, with the beauty of form and design.

The designer of anything at all should be a profound student before he is allowed any activity and should be as familiar with the best designing that has been done in the past as he is with his own collar button. But most of them do not read enough, many of them do not read at all. Otherwise the libraries and art museums would not have the atmosphere of churches or have to advertise for visitors. The art museums and public libraries, particularly the Museum Library in the Metropolitan Museum of Art, are looked upon by the public as sacred tombs of dead achievements (very "highbrow" and visited and entered by people more or less on their "tip-toes") instead of being as they are, like banks with untold riches in them to be drawn upon by anyone, whenever one feels like doing so. Museums and libraries are the friendly temples of modern times and have much of the maternal atmosphere which built up the early Christian church and made it the mighty institution and power it still is. Bless them, and all of the kindly folk connected with them.

People are apt to feel that all of the works in the museums are exceptional examples of past workmanship when really nearly everything in them with the exception of the world famous examples of paintings, sculpture, etc., by known masters, are simply the average work which every skilled workman was doing at that time. They must have had a jolly time in the doing of it—there is a noticeable sense of humor through it all.

I AM wholly in sympathy with the modern workmen and I am for them, and think they have been cheated out of all the fun of their work. I believe if they could get some of their individuality "out of their systems" by more work fashioned by their own hands, there would be more happiness and pride of work, and less unrest, as I believe every man is a potential artist or craftsman of sorts if he had the opportunity to develop, and we are mostly Cro-Magnon cave-men.

I know it is so from my own experience. I have had men who were "failures" and could do nothing in particular and were "Jacks of all trades," (which last by the way are the most intelligent persons one may meet.) They were usually "fond of tools," however, and rarely younger than fifty years old, or older. And in a month or less they were doing amazingly beautiful work. Which proves the over-estimation of technique. To me one of the most impressive things in nature is an unusually intelligent man. He can almost without effort or any previous knowledge, do anything and understand almost anything. It is such men who like this work and the doing of it. The technical end of the work is usually only a matter of explanation, after which he finds his own way and individuality and becomes a master of it and not a "hand."

All of this exemplifies the spirit of this way of working and it is no "stunt" nor is there anything remarkable about it. Nor is it done in the Greenwich Village spirit of faddish amateurism and affectation. It is a man-size job done by real he-men of middle age who have a great time doing it as they know it is good and they are proud of it and feel kindly toward everybody. What is to be lamented is that it is so costly that it is only for the rich in culture, wealth and knowledge as it is done regardless of time or expense, and for that reason I repeat what I said in the beginning—"of little commercial value and of small interest to the average public."

Although as "Lo the poor Indian" used to say, "It is good medicine."

What Architects May Think About in 1921

A Summary of Numerous Conversations with Many Prominent Members of the Profession of Architecture, in Which the Subjects Treated in This Article Stood Out Above All Else

Editor's Note:

To stand as a sign-post of intellectual activity in any profession is a rather dangerous and quite often a thankless task. Dangerous because the men who compose any of the professions, and especially that of architecture, are not the sort, naturally, given to pliant submission in matters affecting their individual processes of thinking. Thankless because professional men rightly resent any arbitrary attempt to "direct their thought."

This article has been written with these factors thoroughly in mind. There has not been the slightest idea, in its writing, of assuming a "thou shalt think thus" attitude. Rather, it is an honest attempt to speak frankly and more or less fully of certain phases of the profession of architecture which appear to the Editor of this journal to be the things most important in architectural thought for the coming year. It is not an editorial, but rather, as has been stated, a summary of numerous conversations in which the things spoken of throughout the article seemed to dominate the intellectual activity of many prominent members of the profession.

WHAT are the important things for architects to think about in 1921?

This is a broad question. To answer it fully would require volume upon volume, and would really get one nowhere. A better approach to the subject, and a more satisfactory one, is to limit whatever discussion there is upon the matter to a few things which seem to be significant and which appear to be the things which architects actually will give most thought to during the year. With that view in mind, prominent architects in all parts of the country were called upon by this journal, either personally or by means of correspondence, to tell what they considered the big things for 1921. In order to get a frank expression of opinion, it was necessary to promise that no individual would be directly quoted. That promise has been strictly maintained.

One of the outstanding facts developed in this canvass of opinion had to do with the conservation of architectural resources. There was not a single architect who did not speak of this as a vital affair. It was not looked upon as a constantly recurring and therefore hackneyed subject. One architect in speaking of it, said:

"It is time we do more in this matter. All architects realize that it is a most vital affair. We have discussed it from almost every conceivable angle, but what have we actually done?"

Another member of the profession, internationally famous, spoke of the conservation of architectural resources as it applies to large cities, such as New York or Chicago. What he said was both interesting and novel, since it got away from what might be termed the usual architectural viewpoint.

"The only way you can conserve architectural resources," he said, looking down upon a section of New York which distinctly emphasized the necessity for such conservation, "is to pass a constitutional amendment defeated some years ago on excess condemnation. The law provides authority for state or city to take what it needs for highways or other public uses by condemnation, but no condemnation in excess of actual usage. The *New York Times*, when that paper was in the height of its power, editorially opposed it on the ground that it was likely to be misused and become a powerful factor for graft. That may be the price you have to pay for improvement, in a public democracy. Central Park itself was built by a notorious political administration. The Speedway similarly. Other public improvements have been done the same way. But the *Times* opposed it. If you had the right of excess condemnation the scheme suggested could have the right of resale under restriction, and when you do that, under restriction, you can restrict and *maintain* the restriction. This area where we are now was restricted. The zoning law restricted this one. By combination of condemnation of streets, and restriction laws and zoning laws, you would get an intelligent scheme which would give people a chance to live. Develop also convenient lines of traffic. In Grand Central, for instance, trains pull in and pull out by the same place. Instead, let the traffic be continuous in one direction. Manufacturers should be at the ends of the city, shops in the central portions."

There are architects who disagreed with this very practical viewpoint. Not so much with the soundness of it, as with its philosophy of accepting things as they actually exist and of making the best of them. Here is a typical opinion:

"We know that architectural resources are not being conserved, and we know that by accepting certain facts in the political make-up of cities or towns such resources could well be conserved. But why should we accept the thing that way? Why not start at the bottom and work properly? It may well

be said that good comes from evil practices, but it must be remembered that the day of reckoning *must* come. I believe the only way to attack the problem is to start at the bottom. Clean house thoroughly or don't clean it."

ARCHITECTURAL resources naturally give rise to some thought concerning regional types of architecture. This, in the opinion of almost every architect whose opinions regarding architectural prospects for 1921 were obtained by this journal, is one of the big things to think about. There are those who believe that regional types can be more or less forced upon communities, in the sense that architects can definitely give a certain style or color to the architecture of those communities. Theirs is the "immediate" view which holds that regional types will develop only when architects emphatically insist upon a correlated attempt by members of the profession to put into certain communities a definite scheme of treatment. They agree with one of the world's most prominent architects that "the thing cannot be done by anything like a propaganda or fiat," and that climatic conditions of the country "would assert themselves in time." But they insist that climatic conditions governing such matters exist *now*, and that Nature having done her work, it is up to the architect to contribute his share.

Regional types, states this prominent architect, cannot be attained by fiat. In that part of the thinking world in Italy, when people lived in isolated communities, communication was to some extent interrupted. Regional development then took place, and more particularly when the regional character had become more or less crystallized. In the early days when Rome ruled the world it would be difficult to determine whether a Roman arch built in Syria or a Roman bath in England or a Roman theatre in France had been designed for the location in which it was built or for somewhere in the environs of Rome itself. But when the Roman Empire had dissolved and Italy had become a country composed of separate states each protesting its individuality, communication to some extent having been interrupted, the national views of the people of each community began to express itself along the lines of precedent with which it seems to develop its type, in accordance with its needs, and so you find in Sienna and Florence, cities not farther apart than an easy afternoon's automobile ride, a very good development of regional architecture. So one thing must have been in Florence, another in Sienna, another in Rome. It was the expression of the natural instinct of the people to some extent, and to some extent the reversion back to original regional ideas. The Lombard built as a Lombard. The Etruscan built from the stand-

point of the Etruscans, although the race had disappeared. The Neapolitan built a conglomerate sort of thing that indicated the conglomerate population from which he sprung—Greece, Spain, Arabia, Rome and all the mixed races of the world. Hence the mixed and conglomerate sort of development.

IT will be so in America, and you will find that as time goes on and our 144 years of national life has developed into 500 years of national life and, let us hope, peaceful development, the individual sections of the country will come to self-consciousness and self-expression, and that new needs will create new types. That cannot be done in a month. There are so many analogies in nature that indicate that nature works in the same way. A pine tree grows on a high altitude where a palm tree would not and each grows to its own needs. The branch of the pine slopes to a base that would carry the weight of snow and resist wind and the palm does not. Nature works in the same way whether with inanimate or animate things. Architecture shows a growth of evolution. There may be a powerful intelligence in some receptive community and around him will be a group that will accept his dicta and from him develop a cult. In Hildesheim a bishop centuries ago developed an artistic community where the neighboring Huns fell back into barbarism. In Spain is the constant recurrence to two great factors in civilization: one the Roman, the other the Arabian, neither Iberian in character, neither indigenous to the soil, but both the result of a powerful and dominating intelligence that had at one time occupied that area and familiarized the people with types that best seemed to meet their needs.

Therefore no artificial development of a national style can be looked for. I look for it just when the national need requires it, and that we are accomplishing such a development at the present time can be perceived. The English at a certain period tried their best to import the Italian Renaissance architecture and made wonderful successes in Renaissance, but no one for a moment would contend that Wren's churches had anything of the aspect of an Italian church. They are English and always will be. Climate influences a country's sense of design. Certain details are obtrusive, but it is necessary that they should be so if they are to be seen at all in an atmosphere which so large a part of the time is dull and colorless. The English country house with mullioned windows results from the same climatic conditions. Our own country houses developed from climatic conditions. Southern California, for example. Climatic conditions, and regional construction. It is a happy thing that types of this sort are being developed.

THE AMERICAN ARCHITECT

WE are evolving a regional type and regional characteristics and it is not at all difficult to perceive it. But it will not develop into definite stylistic forms for a long time.

How can you expect a regional type to develop when the country absorbs at least from one to ten per cent. of its population from foreign countries?

But was not the whole country at first "foreign"? arises immediately in a listener's mind.

Here is the answer to that:

"The Colonists built towns but did not intermingle. They were isolated. Those that were close together were very largely from the same Anglo-Saxon root, so there was not a material difference between the influence of the Dutch in New Amsterdam and New Jersey, the Swedes in Delaware and the Germans in Pennsylvania, and especially was that true because those countries were themselves very closely related. Did not the Puritans in England go first to Holland before they came to America? This had no influence on architecture, but shows the interrelation between England and the Netherlands."

A man who is unquestionably one of the world's great architects gives the practical application in the following comment:

The development of regional types in architecture naturally implies a building program. "But when?" is the big question of the day. The answer to this question was almost unanimous, and is very well expressed in the one quoted below. There is quite a bit in that answer regarding paternal legislation in building activities. That, in the opinion of a great number of architects questioned by this journal, is a big thing to think about in 1921.

THERE will not be a *quick* resumption of building," this architect holds. "The weight is too great to move quickly. But it is bound to come. I am very optimistic about it. But it will not come if we have excessive labor prices or combinations of material supplies. You have got to normalize conditions and I am optimistic that we will be able to do so. I do not think the banks have retarded resumption. The chief source of retardance is high prices. It is fundamental that no one wants to pay more than a thing is worth. Only extreme necessity drives him to do it. Any one who invests in a building for rent, no matter what type of building it is, has to keep his average income for a period of years. He cannot afford to build on a high market unless he is sure to have high rents for sufficient time to amortize what he pays and what competitors will pay in ten years. Renting is a business. It invites investment by reason of opportunity for reasonable profit. Laws that obstruct reasonable profit and discourage men from taking risks are not going to produce more buildings.

As a general proposition it is a debatable one that the attempt to legislate in a paternal way is contrary to the interests of democracy. The large portion of the distresses that communities suffer is from excessive legislation. Think of the old independent spirit of the American people, who scorned to take refuge under legislative action and built up a spirit of personal independence. I do not believe at all in paternalistic legislation. You cannot legislate the law of supply and demand out of existence.

WHEN communities come together the conditions of human life vary from when individuals live apart. The more there are, and the closer together, the more necessity there is for the maintenance of the rights of individuals one against the other. Only for that would I legislate.

The moment you begin to fix values, of farm products for example, you have interfered with the benefits of the farmers. You have not done any good. He was induced to plant wheat to meet a great necessity, not on the basis of supply and demand, but because the government guaranteed \$2.35 for wheat. When the price of wheat went up the cost of bread went up. Then everybody thought they would get what was coming to them because they thought they could get it, and also because they needed it. Then the farmers had to pay more for labor. The efficiency decreased. The farmers found the price of wheat falling. The supply was met. For a time he could not get his product to the market because no railroads were available. Over-legislation attacking railroads caused confusion to transportation. Hill said ten years ago that to put railroads back would cost \$50,000,000. The government took the railroads for the war. The government broke the railroads down by congestion. Ten yards of ten shipways each would have been better than one yard with 100 shipways. The farmer sees that while he thought that at \$2.35 he was going to make money, he has to pay \$10 a day to harvest his wheat, so he does not make so much as he did when he got only \$1 a bushel for it.

Such comment brings to mind the oft repeated question: "Is architecture a business?" A very prominent architect recently termed this a "banal" question, but he gave an answer to it which in itself is something to think about every day of the year.

He referred to the subways of New York, and to the insistent demand that new subways are sorely needed. The present interest paid by the city, he said, is about \$45,000,000 a year. A little over four hundred millions more is contemplated for subway construction.

"Four hundred million is spent on rapid transit, to say nothing of the interruption to business during

(Continued on page 15)

Old Shop, Litchfield, Conn.

(See reproduction of original drawing by O. R. Eggers on opposite page)

LITCHFIELD'S history dates from its settlement in 1720. It grew as all New England towns of earlier settlement grew with winding streets and shaded lanes which truly typified the simple characters of the early inhabitants.

Its builders built as did all the early New Englanders with a fine regard for the basic elements of good architecture and even the humble shop was not too insignificant to receive the careful thought of its designer. There is a most satisfactory indication of good design and honest building in the present subject so well presented by Mr. Eggers, who found many equally satisfactory subjects for his book of sketches during a visit to old Litchfield. Litchfield preserves its traditions, which teem in historic association, and it is equally proud of its record as the birthplace of many illustrious men.

The first law school founded in the United States was at Litchfield, as was also the first "woman's seminary," the forerunner of the woman's college. Lyman Beecher, the father of Henry Ward Beecher and Harriet Beecher Stowe, was a much respected pastor of a Litchfield church, and it was in Litchfield that Henry Ward Beecher and Harriet Beecher Stowe were born. Ethan Allen was also born in Litchfield.

When the murmurings that marked the days before "the shot heard round the world" was fired at Lexington, and the Revolutionary struggle was begun, Litchfield had rounded out a half century of growth. Many old buildings stand today that stood then as silent witnesses to the part this quaint New England town played when it sent its manhood forth to join the Continental armies.



OLD SHOP, LITCHFIELD, CONN.
THE AMERICAN ARCHITECT Series of Early American Architecture

THE AMERICAN ARCHITECT

(Continued from page 13)

construction, also a cost. The interest on that at 4 per cent. would be \$16,000,000 per annum. If you took only half of that, namely \$8,000,000 a year, and spent it in building a series of diagonal avenues linking up east and west sides of the city with facilities for playgrounds, short cuts across town, convenience in traffic to the business section, you would open up a section now in bad condition and do it at least as well as Naples thirty years ago, when they re-zoned that city; and for \$6,000,000 to \$10,000,000 a year you could have a permanent investment that would amortize, that provides a convenient living place, that would do away with a large portion of your subways and save original cost to a considerable extent. With diagonal avenues you would not have the north side of the street with all the sun and the south side with no sun at all. You could have both sides of these dwellings exposed to the sunlight. You would have broad avenues; you would have places where people might promenade and for streets carrying traffic and would assume at minimum cost that instead of carrying the live human people in holes in the ground out of the sunlight like a lot of moles, and the freight or traffic in the sunlight, you could have some traffic subways to take freight and let the people occupy the surface where they belong."

Now, that opinion is extremely valuable, and most certainly furnishes something to think about, when it is remembered that the man who gave it to this journal is an Immortal, a member of the Legion of Honor, has won the Medal of Honor for Architecture, and has achieved distinction and fame as one of

the finest *artists*, in every sense of the word, in the profession of architecture. If he can give time and thought, as he undoubtedly has, to matters as commercial and material as taxation and subway construction, as well as to the more aesthetic side of life, it would seem that the consideration of the time-worn and timely "Is Architecture a business?" question would well merit very serious thought this year.

Last, but not least, is the matter of the registration of architects. Full comment on this would require many issues of this journal. We print the following comment, because it is rather new and seems to us to be a thought-provoking statement:

"Registration does not make for any better architects or any better service to the people. It adds to taxation. It would not keep out incompetents. You cannot pass a law stopping the country carpenter from building a barn. I believe that branches also on paternalistic legislation. The best protection for the public and the architect both is the establishment of high standards of public information in regard to what constitutes good design and good building. The survival of the fittest does not necessarily hold good because a man may make up in activity of solicitation, like any other quack, what he lacks in genuine ability, and get the business."

These are some big things to think about in 1921. They are not the only things worthy of serious consideration, but most certainly they are the big ones, if opinions gathered from all over the country can be taken as an accurate gauge of worthwhileness. This journal believes it is an accurate gauge—an extremely accurate one.

The Building Outlook in the Middle West and on the Pacific Coast

(Special Correspondence to THE AMERICAN ARCHITECT)

CHICAGO.

THE building fraternity in Chicago is welcoming the new year with much more than the usual acclaim because of the potential progress in the industry which the incoming year seems certain to possess. Everything points to an early and comprehensive resumption of building activity, which will keep all hands busy during the year and beyond.

Practically no one who is in a position to gauge present indications dissents from the general tone of optimism. Real estate men, contractors, builders, architects—everybody who touches the building industry seems well assured that the long-needed expansion is certain to begin early in 1921 and to continue without interruption for an indefinite period.

The psychology of the situation favors this expansion; the labor problems are becoming simplified; material costs are being reduced; the need of buildings is growing more acute and the financial aid necessary to make the building program possible now seems more easily available. With all of these concomitants so favorably disposed, there is really nothing in the way of the forward march. Even the mild weather now prevailing seems auspicious and may mean the opening of many important projects much earlier than could be usually expected.

A very optimistic expression comes from Henry K. Holsman, president of the Illinois Chapter of the American Institute of Architects, who believes that the approaching season will be marked by great building activity.

"I am constantly in touch with a great many architects," says Mr. Holsman, "and my information is that the architects are going to have all the work they can possibly do. A great deal of work is already on the boards, with many plans already completed and merely awaiting the word for actual work to begin."

Charles M. Bostrom, Chicago commissioner of buildings, is another who predicts record-breaking activity. Chicago's greatest building boom will shortly begin, according to Mr. Bostrom, and before it is finished living quarters for the present unaccommodated 100,000 families will have been built. He estimates that at least ten square miles of property now vacant in and around Chicago will be covered with homes and apartments during the building renaissance.

Mr. Bostrom's records show that the first eleven

months of 1920 saw the issuance of permits for buildings valued at \$74,000,000 as compared with a valuation of more than \$95,000,000 for the same period in 1919. Permit valuations for December of this year are estimated at \$3,000,000.

Chicago's record building year thus far was 1916 when permits representing a value of \$113,000,000 were issued, but it is Mr. Bostrom's belief that the building in 1921 will set a new mark for progress in Chicago.

A word of very great encouragement comes also from S. W. Straus, head of an important Chicago financial house. He points out that there has been great improvement in the conditions which have previously hindered building and he expects an immediate resumption of building activity as soon as weather conditions become more settled and favorable.

"While construction is at a low ebb at this time," said Mr. Straus, "conditions are favorable for the resumption of building on a large scale."

Even more emphatic emphasis of the encouraging outlook than that given expression in mere individual views may be found in the news of the actual building improvements under consideration at this time. Most of these projects have passed through the nebulous stage and are definitely under way.

It is reported that the building program of the University of Chicago which was held up by the war is about to be resumed. Very vast expenditures are contemplated, among them the erection of the important medical group of buildings at the university. Northwestern University on the north of Chicago also has some very important building plans which are shortly to be revived.

Announcement has recently been made of plans to raise \$1,000,000 for a new hospital on the Chicago Southside. The site is that now occupied by the Woman's Hospital at 460 East 32nd street. This property has been sold to a new corporation known as the Illinois General Hospital which will be the name of the new and larger institution. Clubwomen in Chicago are behind plans to start an early drive to raise funds for this new project.

News of a 21 story hotel project to cost \$5,000,000 is also current in Chicago. The site of the proposed new hostelry is the now popular Union Station district, the exact location being at Canal and Clinton streets. Property has already been secured by the



HOUSE OF JAMES J. HILL, OLD WESTBURY, L. I., N. Y.
WALKER & GILLETTE, ARCHITECTS



HOUSE OF JAMES J. HILL, OLD WESTBURY, L. I., N. Y.
WALKER & GILLETTE, ARCHITECTS



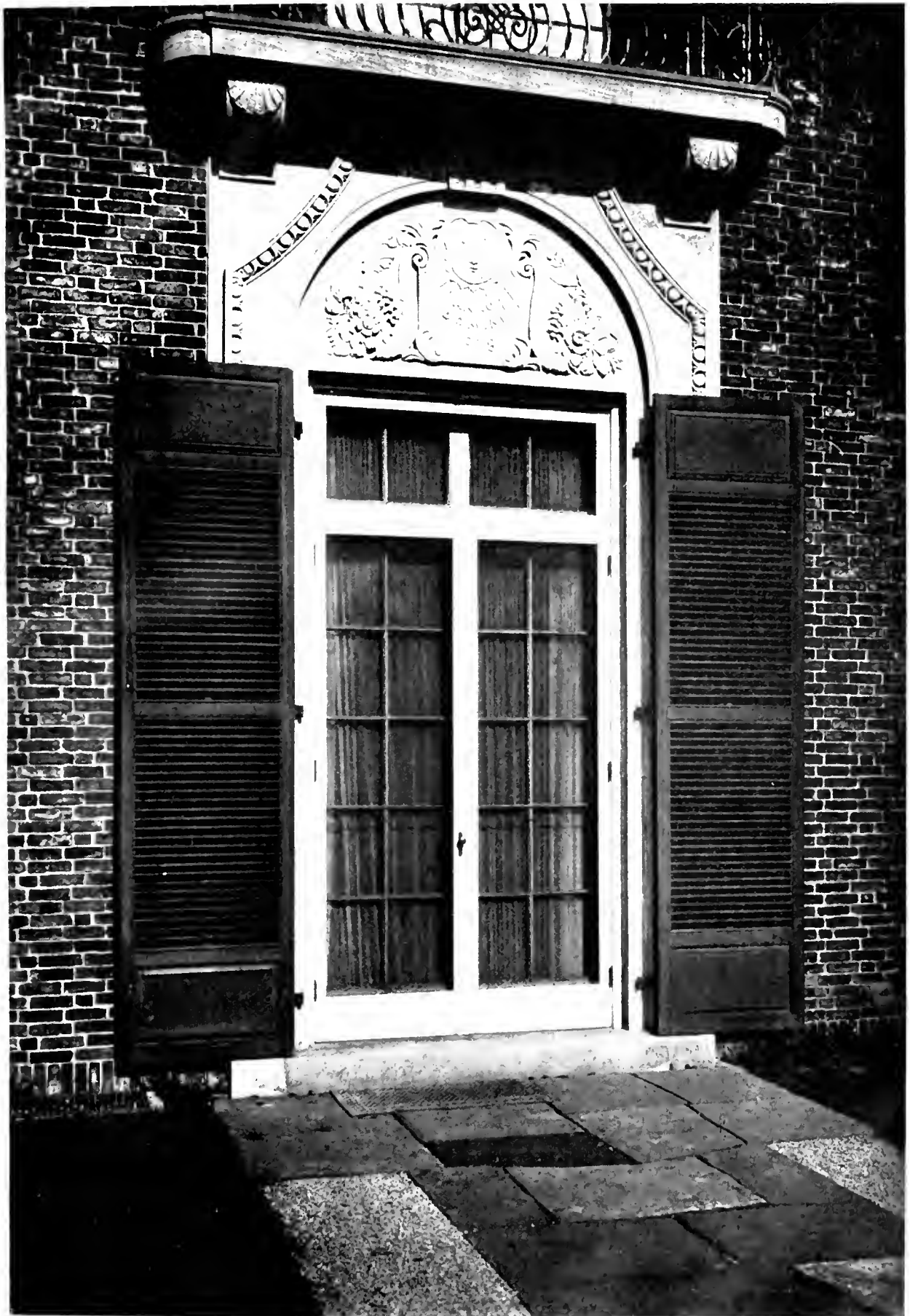

HOUSE OF JAMES J. HILL, OLD WESTBURY, L. I., N. Y.
WALKER & GILLETTE, ARCHITECTS

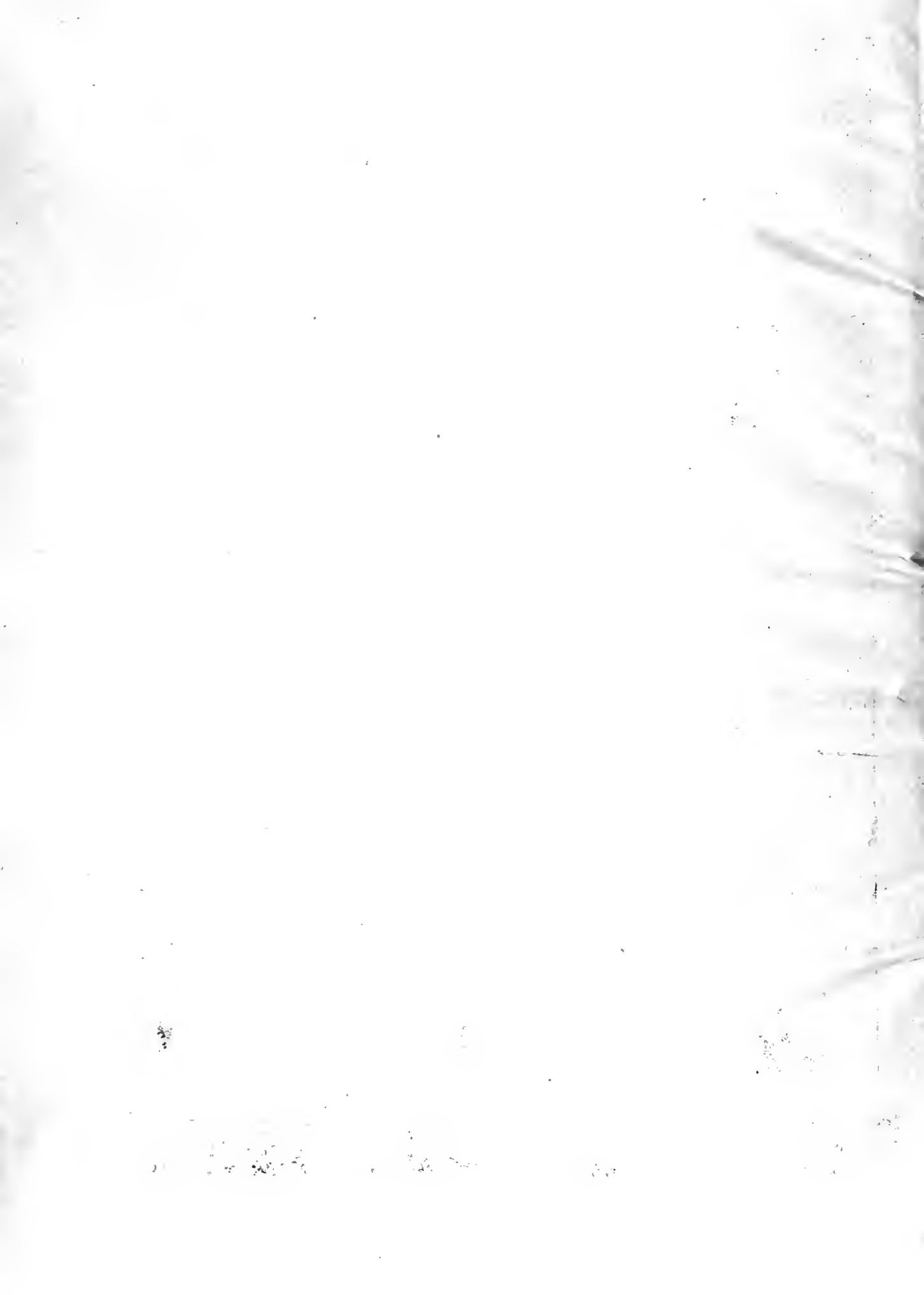



PORTE COCHERE
HOUSE OF JAMES J. HILL, OLD WESTBURY, L. I., N. Y.
WALKER & GILLETTE, ARCHITECTS





ENTRANCE DETAIL
HOUSE OF JAMES J. HILL, OLD WESTBURY, L. I., N. Y.
WALKER & GILLETTE, ARCHITECTS

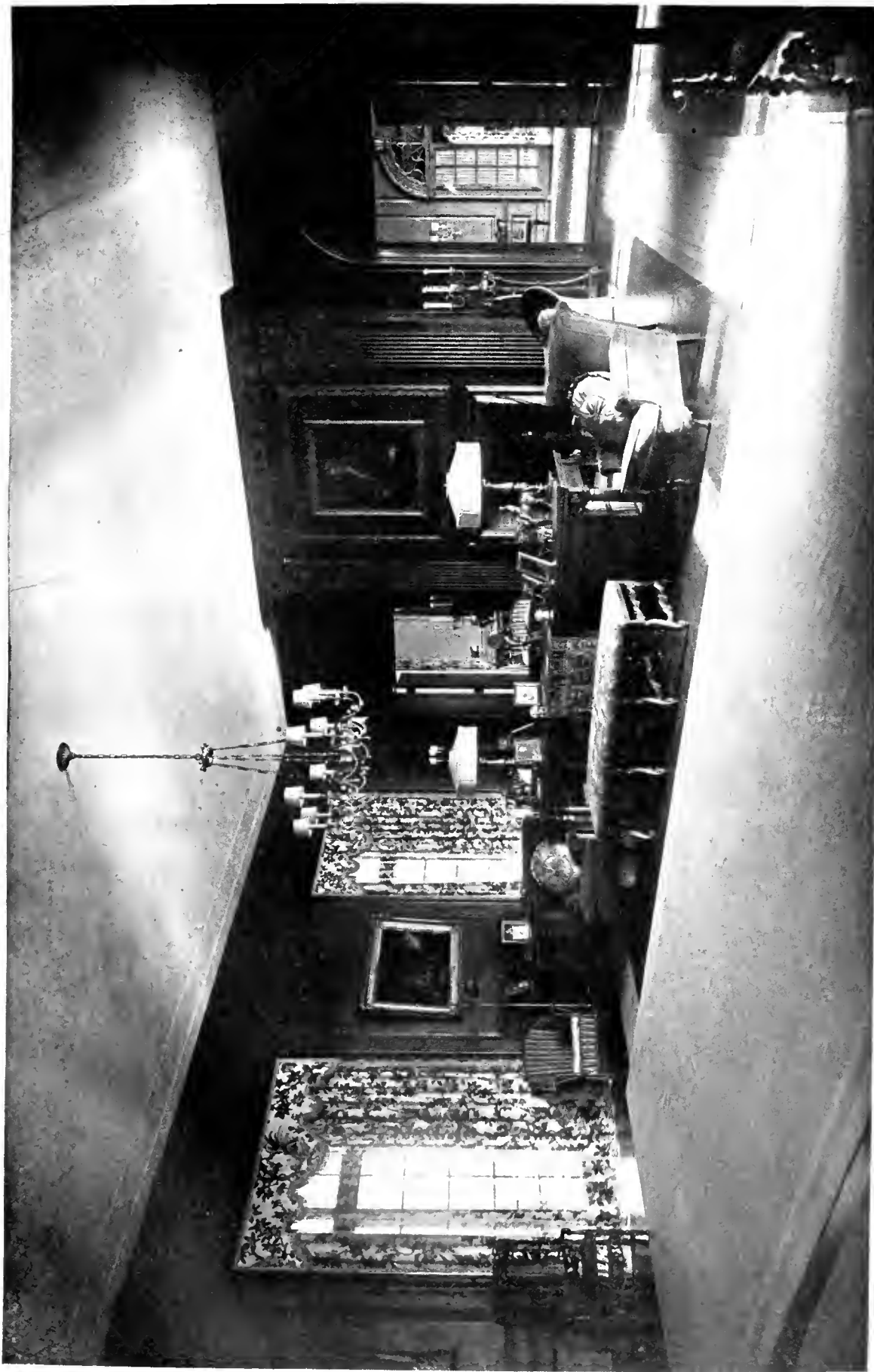

THE LIVING ROOM
HOUSE OF JAMES J. HILL, OLD WESTBURY, L. I., N. Y.
WALKER & GILLETTE, ARCHITECTS

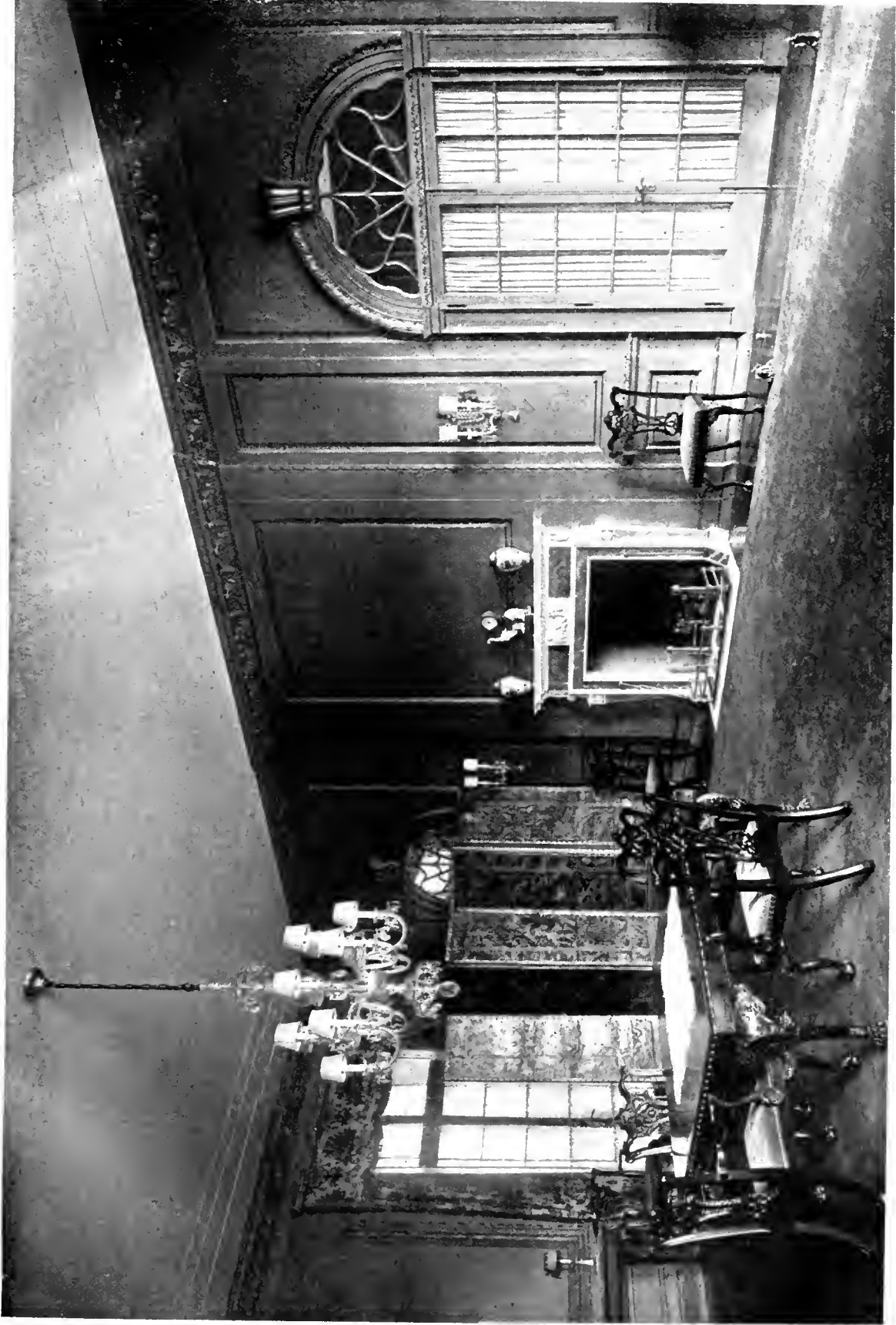

THE DINING ROOM
HOUSE OF JAMES J. HILL, OLD WESTBURY, L. I., N. Y.
WALKER & GILLETTE, ARCHITECTS



HOUSE OF JAMES J. HILL, OLD WESTBURY, L. I., N. Y.
WALKER & GILLETTE, ARCHITECTS



Arthur R. Jones Syndicate which has the project in hand. The buildings on the property will be the hotel already mentioned and an office building to supply the needs of this important business section. The hotel will be connected by means of a boulevard subway with the station, after the fashion of the Grand Central station in New York with its hotels adjoining.

The Union Station improvement will give new impetus to building in this part of the city and a gradual upgrowth of the entire wholesale section in that vicinity is anticipated. Rents, in fact, are already feeling the pull of the improved situation and new leases are being made on a higher rate.

Chicago's greatly needed new postoffice building is also to grace this same general locality. The exact location is at the northeast corner of Jefferson and Quincy streets, a half block west of the Union Station. The building will cost in the neighborhood of \$1,500,000. It will not displace the general postoffice in the Federal Building at Dearborn, Clark and Adams streets but will be utilized to relieve the mail congestion which results from the inadequate size of the present building. Alfred L. Alschuler is the architect of the new postal station, upon which work will begin in early spring.

Theatrical progress is to add its share to the building boom. Three new theatres in the downtown district are said to be in contemplation by the Shubert interests, though nothing very definite has been given out as to plans. More tangible is the proposal of an unnamed eastern syndicate to erect in Chicago a chain of outlying vaudeville houses at a cost of approximately \$4,000,000. The first of the chain will be a \$300,000 building on West Roosevelt Road near Ashland avenue.

Definite plans for the new Federal Reserve Bank building, for which excavation is practically complete have lately been made public. This building to be located at La Salle Street and Jackson Boulevard will be fourteen stories in height, with provisions made for the addition of four stories should the first limit prove inadequate. Architecturally, the building will be a free interpretation of Greek and Roman classic style, the outstanding feature being a front colonnade, sixty-five feet high.

The cost of lumber and other building materials has taken no important decline during the past week or so. The feeling is general in the lumber industry that the building boom will drive prices upward and this hope is doing a great deal to firm the market.

Following recent revisions, the materials manufacturers are also holding firm, with no change of importance in the list of prices.

A general summary of building and materials quotations follows:

Yellow pine:—B. & B. 1 in., \$95 to \$130; 13-16,

3¼ flat flooring, \$85 to \$90; 2 by 4, 10 to 16 feet, No. 1 long leaf, \$51; 2 x 6, \$48 to \$49; 2 x 8, \$49 to \$50; 2 by 10, \$52 to \$54; 2 by 12, \$54 and \$56.

Northern Hardwoods, carload lots, Chicago:

Birch, four ¼ No. 1 and 2, \$155; select, \$130 to \$138; No. 1 common, \$95 to \$100; No. 2 common, \$60 to \$65; No. 3, \$35 to \$40.

Hard Maple, four ¼ No. 1-2, \$135 to \$140; select, \$115 to \$120; No. 1 common, \$95 to \$100; No. 2, \$60 to \$65; No. 3, \$32 to \$50.

Red gum four ¼ No. 1 and 2, \$148 to \$152; No. 1 common, \$88 to \$92; No. 2, \$43 to \$47.

Birch, four ¼ No. 1 and 2, \$155 to \$160; select, \$130 to \$139; No. 1 common, \$95 to \$100; No. 2, \$60 to \$65; No. 3, \$35 to \$40.

Douglas fir, 12 by 12, No. 1 up to 32 feet, \$65 to \$75; 14 by 14, \$68 to \$75; 16 by 16, \$70 to \$75; 18 by 18, \$75 to \$80.

Cement:—Universal, \$3; Lehigh, \$3.00; Portland, \$3.00.

Bulk lime, \$1.70 to \$1.90; face brick, octagons, \$68 to \$75; fire brick, \$32 to \$40; 12 in. .24 to .27, 18 in. .46 to .54.

Crushed stone gravel \$3.40 to \$4; lake and bank sand-torpedo, \$3.40 to \$4.

SEATTLE.

NOT until an American dollar will buy 100 cents' worth of steel and hardware will building over the Pacific Coast be resumed in the proportion hoped for, and American business go on a basis that will be safe, sane and profitable. This was the tone in which large hardware, sheet, pipe and nail operators defined the situation for 1921 this week. It is contended that the steel mills have not responded to the demands of the hour, and that other marketing avenues, in guaranteeing prices on building essentials as they are offering to do today to jobbing houses are outside their rights if they propose to aid the country in getting back to normal.

The general tendency of jobbing houses on the coast, which include all steel and shelf hardware, sheets, roofing, cement and wall board is to refuse to buy, taking on only what can meet the narrowed requirements of the year-end. In this way, with individual action prolonged, it is felt that stocks will accumulate in the hands of manufacturers and that a price tumble will be inevitable. Corroboration of this position is shown in the fact that salesmen have increased in number, eastern steel mills have found it necessary to personally scan, cultivate and tactfully view the field in person. However, the minds of jobbers seem to have been made up, particularly since it is known that gross margins in the North Pacific jobbing trade were not moved upward during the war as in other sections, and the jobbing trade protected its customers by keeping as close to reasonable

THE AMERICAN ARCHITECT

profits as was possible at that time. Jobbers claim that it is impossible for any one of the many lines of construction material to guarantee prices to-day until March 31, as is proposed, or for twenty-four hours, and the point has been raised as to whether it can be done in conformity with law. This attitude of manufacturers has stirred jobbers into a belligerent mood, and buying will be limited in the Pacific coast territory until the future basis is modified.

There is an ample supply of nails, pipe, all but halves and three-quarters galvanized, and nails. Stocks of roofing, cement, fire brick and plaster wall-board are ample to take care of the estimated need for the next ninety days. Jobbers in steel products announce that they will follow all declines in the market regardless of cost.

Whenever steel mills more thoroughly reflect the national temper in their price list, at that time the reconstruction period will begin. This is the crystallized sentiment of nine out of ten of the heads of corporations engaged in distributing these products over the Pacific coast territory.

It is believed that fir lumber has struck bottom. A good many price lists are going to eastern commission houses, but save in the case of financial pressure prices are being held taut. The larger mills are refusing to accept business on the market of to-day and wages have fallen \$1 to \$1.25 per day, to \$3.75.

Production for the week was 38½ per cent. below

normal, and fir mills of the west coast territory sold only 769 carloads, 30,000 feet to the car, in the rail or eastern building trade. The mills hold orders for 2,736 carloads, still unshipped. The cut at the mills and the shipments were only 1.50 per cent. apart, a situation that has not been paralleled in months.

Negotiations for moving fir lumber and shingles to New York, Boston and Baltimore intercostal are going forward rapidly. Association authorities took up with the steamship lines the subject of low rates immediately after the railroads instituted what has become a prohibitive transcontinental rate, and comparison shows that the water haul to New York harbor will save shippers \$14.60 per 1,000 feet on lumber alone.

Lightering rates in New York harbor and to Boston and other ports that have yardage space for lumber cargoes have been filed here, and a rate of 17 cents per hundred pounds from New York to Buffalo via the Erie Canal has been named. The railways stand to lose the lumber as they have lost the steel tonnage west bound, as well as the backhaul to interior points.

The fir mills this week sold mill base at \$51 to \$57 for vertical grain flooring, \$29 to \$31 for slash grain, \$63 for finish, \$27 to \$29 for ceiling, \$28 to \$30 for drop siding, \$18 to \$20 for boards and shiplap, and \$13.50 to \$16 for common dimension.



The Outlook as to Building Material Costs in 1921

By A. R. KRIECHBAUM, *Eastern Editor, Lumber*

THE fundamental soundness of America is a guarantee for better business in 1921. This applies more particularly to the building industry than to many other lines of industry because the nation is at least four years behind in its building construction. The war taught the people of America many things, the most important of which was economy. Economy in housing space as now practiced would have been considered intolerable a few years ago, but this very thing has created business in the building material industry at a time when retrenchment in all lines has been general. The remodeling of buildings to provide more space for housing accommodations has furnished the principal demand for building materials during the past several months. This remodeling work, creating two apartments where there had been but one, is purely an emergency measure, and while it answers the purpose just now, it does not lessen in the slightest degree the potential demand for housing in this country. This demand must be met sooner or later. It remains for someone to start. Under existing business conditions the large investor has not been anxious to put his money in the building field when he could lay it away in tax-free securities. That this chief adverse element even now shows signs of improvement, however, is indicated by the fact that the larger insurance companies, building and loan associations and banking institutions are displaying a much more liberal attitude towards the building industry, particularly with reference to loans on individual housing projects.

Following as it did the artificial boom which began immediately after the signing of the Armistice, the period of depression of the past few months was fully expected, and, in fact, did not reach the proportions anticipated. It resulted largely from public sentiment. The public was sick and tired of high prices and it simply "struck." That the "strike" was won is easily attested by the present prices of all commodities, including building materials. Lumber, steel, brick and cement, the four basic building materials, are wholesaling cheaper today than at any time in 1920, and in many instances this is true of retail prices as well, but as a general rule the retailer has not taken his loss in proportion to other branches of the building industry, except, of course, the laborer. He is taking his loss just now in non-employment.

Building construction will begin during 1921.

Whether it starts in early Spring or later, it is bound to start, and when it is finally under way it will continue for at least three years to come. There are several important elements which bear on the situation, the foremost of which is legislation, both existing and prospective. The "anti-landlord" rent laws enacted by the last New York Legislature virtually placed all rented property in the hands of the courts, and landlords as a general rule prefer to have supervision over their own property. Such legislation offers little inducement to the prospective apartment builder. On the other hand, the law-making body passed another law giving cities the power to exempt from taxation for a period of five years all new construction, and the City of New York is now working on an ordinance to this effect which may become a law in the Spring. This undoubtedly will encourage building.

The sensational disclosures of the Legislative Committees, which have been investigating the building industry for several months, have proven a revelation and have undoubtedly resulted in breaking up several "rings" which in the past have exacted great toll from the public. Prospective builders this year can proceed with the assurance that they will get a dollar's worth of building for every dollar they spend. This, again, will encourage building.

In the matter of material supply, there is everything in favor of the builder, at least for the one who builds early in 1921. The retail lumber yards as a rule are well stocked with lumber, the cement plants have a goodly supply of cement to start with and there is enough brick to keep things moving until summer when the brick plants resume operation. Material prices (the big factor) are very much in favor of the prospective builder. The basic materials are cheaper today than they were at any time during 1920 and the market will probably remain around its present level until Spring. The trend of the market during the last half of 1921, however, will undoubtedly be upward, but prices will never reach the peak of last year, at least, not for some years to come. And it is well that they will not. Any attempt to force prices up to last year's peak would be immediately followed by a stoppage of building.

The labor situation will be favorable to the resumption of building by Spring. Labor is getting more plentiful every day and it is merely a matter of a short time until wage scales will be reduced in the

THE AMERICAN ARCHITECT

building trades just as they are being reduced at manufacturing centers throughout the country. And another important factor is the change in the attitude of labor. The individual is growing more efficient and less dictatorial. He is more willing to perform a full day's work for a full day's pay, which necessarily means a reduction in labor costs, even if wages are not actually reduced.

Transportation, another factor in the building industry, is almost 100 per cent. better now than it was at the beginning of 1920 and railroad officials promise continued improvement throughout this year. Shipments of building materials from producing points are moving smoothly. There are plenty of cars and the terminals are cleared of traffic, a condition which is just the reverse of that of last January. For the first half of this year the big trunk lines will undertake only improvements which are absolutely essential and the roads will be operated with as few men and at as little cost as possible. Their retrenchment policy, however, will not be taken to the point where it will interfere with service to the public.

In all branches of the building industry there is a better feeling of confidence than there has been at any time since the close of the war. Everyone knew that the boom which followed the signing of the Armistice was artificial and could not continue. They knew that the prices which prevailed last winter were entirely too high for the best interests of the industry. For the most part, they welcomed the turn downward, for while many of them lost money by the break in the market, they were able to take their loss because they realized a good profit during the months preceding.

During 1920 more buildings were planned than ever before in history and yet actual construction fell considerably short of that of the previous year. Millions of dollars in new construction, represented by plans and blue prints, are now held in "cold storage" by architects. They have all been approved and in most instances the money appropriated. The architects are waiting until they think prices have reached the bottom before they ask for bids. A survey of architects' offices reveals the fact that housing projects and educational and religious institutions predominate, although there are quite a number of commercial and office buildings in the list. The general

curtailment of production in all lines indicates there will not be such a great volume of industrial building this year. The building now under way is confined largely to the completion of structures started many months ago and to repairing and remodeling.

Manufacturers of building materials are very optimistic as to the outlook for this year. Both the cement and the brick manufacturers declare there will be a shortage of materials. One cement manufacturer pointed out that more than 31,000,000 barrels of cement will be used in highway construction this year, or about one-third of the nation's production. Cement producers are refusing to accept orders on present prices for spring delivery. In a good building year approximately 1,200,000,000 bricks are used. Last year the consumption was only 350,000,000. At present there are only 300,000,000 brick on hand at producing points and this supply would be exhausted in 60 days' time if building was resumed in any volume. The brick plants are closed down for the winter and will not resume operation until after May 1, the exact date depending upon weather conditions. Brick manufacturers will not accept orders for future delivery on the present market values.

In the lumber industry the producers have responded more readily to the downward price tendency than probably any other branch of the building material industry. Most low grade lumber today is wholesaling at less than cost of production. The mills are making some profit on the better grades, but not enough to offset this loss. This means that lumber prices, as a whole, must be higher after spring buying begins than they now are. A great majority of the lumber, shingle and lath mills on the West Coast and in the South have been closed down since the middle of November and most of them will not resume operation until buying begins in some volume. Stocks of lumber at the mills are not up to pre-war normal, but are considerably larger than those of last January. This surplus will be exhausted, however, with sixty days of active buying.

No one looks for a great boom year or the skyrocketing of prices, but for the last nine months in 1921 is generally predicted a period of good, substantial business, and from then on business generally will continue prosperous for the next five years.

DEPARTMENT OF ARCHITECTURAL ENGINEERING

The Cleveland Auditorium

A Notable Example of Architectural and Engineering Skill

ONLY the ordinary palls. And because the world is largely composed of ordinary people, ordinary buildings and many other ordinary things, they fail to excite interest. But the big men, the unusual things, are those that never fail to arouse our interest, our curiosity and often our ad-

investing money, part of which has been raised by a bond issue, in a structure which its citizens firmly believe is a most excellent investment and which will pay handsome dividends in the form of increased business for Cleveland citizens. Although it is not here desired to discuss the economics of the question,



THE CLEVELAND AUDITORIUM AS IT WILL APPEAR WHEN COMPLETED

J. H. MAC DOWELL, ARCHITECT. F. R. WALKER, CONSULTING ARCHITECT

miration. We look on with awe and wish that we also might do big things.

The city of Cleveland, while not ranking with the largest cities, is yet a most progressive one. Just now Cleveland is doing something big in the building business. While private building lags behind and business in many lines is unusually dull, this city is

a consideration of the structure itself is worthy of attention.

The accompanying illustrations will more readily convey an idea of the magnitude of this structure than any lengthy description.

The Auditorium, now under construction, is the fourth building to be erected in what is known as the



RECENT PROGRESS VIEW SHOWING STONE-WORK OF MAIN FAÇADE WELL UNDER WAY

Cleveland Group Plan. It occupies a site on the east side of the proposed Mall and is bounded by Lakeside Avenue on the north, St. Clair Avenue on the south and East 6th Street on the east. This building is 230 by 430 ft., while the arena or public hall proper is to be 220 ft. wide and 370 ft. long. In this vast auditorium there will not be a single pillar to obstruct the view of the army of spectators it will seat. The whole auditorium will be lighted from the ceiling, where the use of incandescents with a total wattage equivalent to 218,000 ordinary lamps is being planned.

Modern fireproof steel construction is used throughout. The exterior is faced with granite and limestone, while the interior is finished in marble, tile and decorative plaster. The requirements to be met in the auditorium were such that the plan could not be well expressed on the exterior by the type of classi-



A SECTION OF THE BALCONY STEELWORK

cal Roman architecture that prevails in the other public buildings of this group. It was found, however, that façades designed in the spirit of the Italian Renaissance were applicable to a true expression of the plan, and this type of architecture was therefore adopted, although the exterior details are classical and harmonize with the other buildings of the Group Plan.

The Auditorium is an exceedingly interesting building because of the many varied functions that it is intended to serve. Many special features are incorporated in plan and equipment in order to fulfill these functions. The purposes for which the Auditorium is designed and equipped to be used may be classified as follows:

CONVENTIONS.

- | | |
|------------------|-------------------------|
| (a) Industrial. | (e) Political. |
| (b) Educational. | (f) Religious. |
| (c) Fraternal. | (g) Sales and business. |
| (d) Medical. | (h) Scientific. |

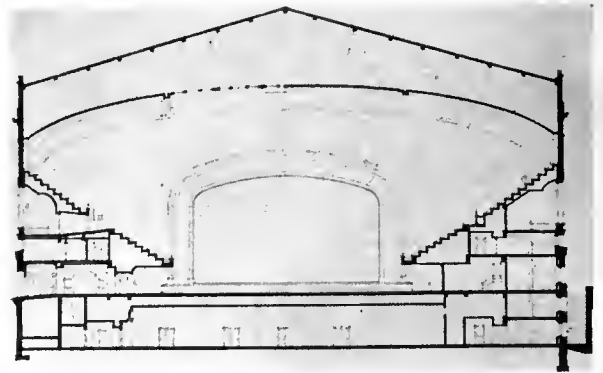

CROSS SECTION LOOKING TOWARDS THE STAGE

ENTERTAINMENTS.

- | | |
|----------------------|-------------------------|
| (a) Athletic. | (f) Military. |
| (b) Balls. | (g) Plays. |
| (c) Carnivals. | (h) Pageants. |
| (d) Circus. | (i) Musical Concer t s. |
| (e) Motion pictures. | Grand Opera. |

EXHIBITIONS.

- | | |
|-------------------------------|-----------------------------------------------|
| (a) Aeronautical. | (i) Farm products (raw) |
| (b) Animal shows. | (j) Building materials. |
| (c) Automotive. | (k) Textile. |
| (d) Machinery. | (l) Industrial methods & and Special process. |
| (e) Electrical. | (m) Plumbing and heating. |
| (f) Chemical. | (n) Forestry. |
| (g) Flower shows. | |
| (h) Food products (prepared). | |

The seating capacity of the Auditorium for concerts and operas is 12,000; during conventions, however, this capacity may be increased to 13,500 by

THE AMERICAN ARCHITECT

placing 1,500 additional seats on the stage. The main floor and basement combined offer 61,000 square feet of exhibition space, 32,000 on the main floor and 29,000 in the basement. Steam, gas, compressed air, vacuum and electric current (A. C. and D. C. 110 volt and 220 volt) are among the services available to exhibitors.

One of the primary functions of the building is the

72 ft. ice skating rink or swimming tank from the basement to the stage level. The stage wings are provided with 28 private dressing rooms and chorus rooms with a total capacity of 200. One of the finest pipe organs in the country is to be installed. Special care is being taken to design the interior acoustically correct.

South of the arena will be a unit housing a com-

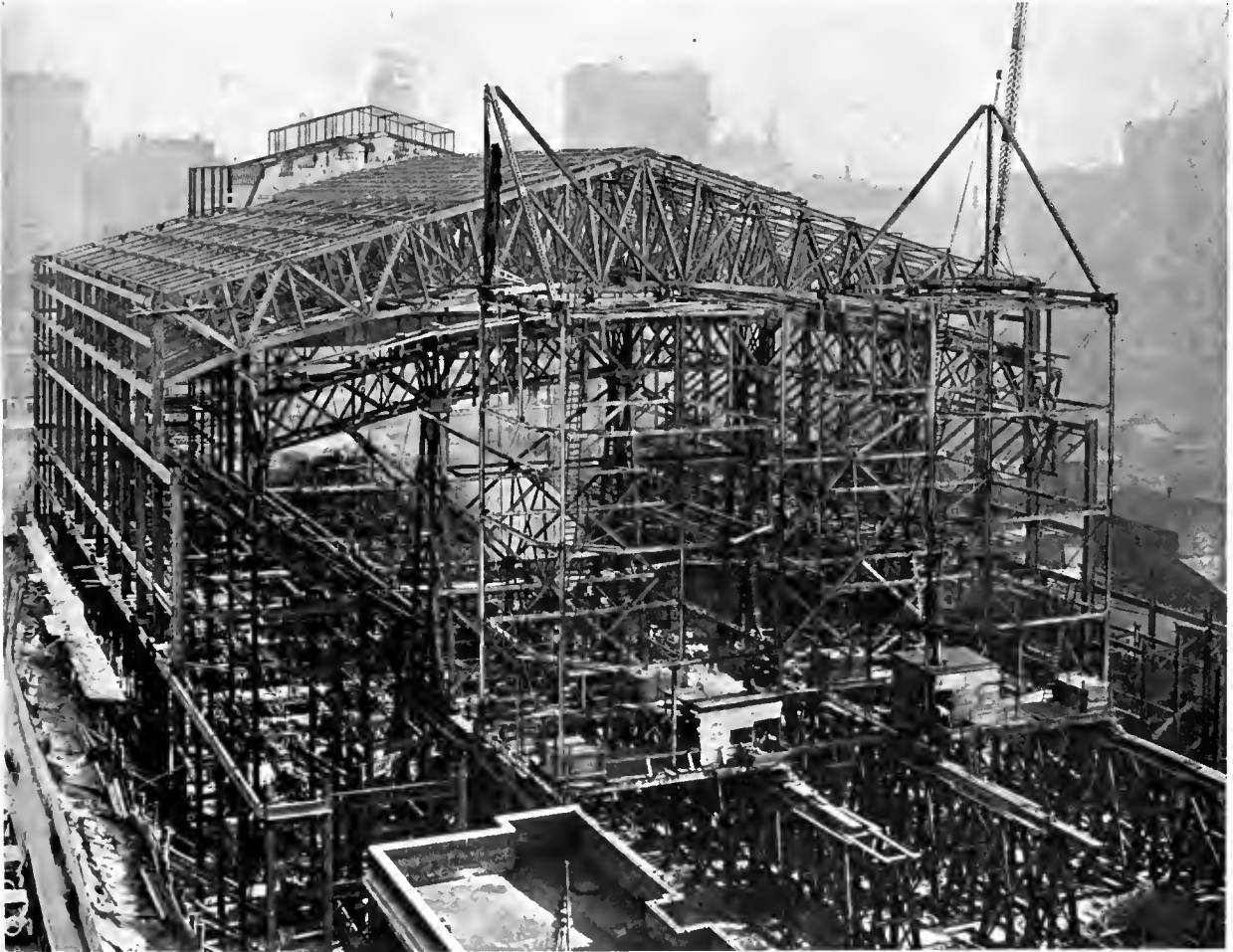

VIEW SHOWING PLANT USED IN THE ERECTION OF THE AUDITORIUM STEEL WORK

Note the two traveling derrick towers in foreground

housing of national conventions. Every dependency required by such conventions is provided. These include suites of large committee rooms with separate entrance foyers, scores of telephones with a private exchange, taxicab service, lunch room, flower shop, barber shop, shower baths, and numerous other accommodations for the convenience of the busy convention delegates.

The stage is equipped in accordance with the best modern theatre practice. It is one of the largest in the world and provision is made for raising a 30 by

plete theatre capable of seating an audience of 2,700 and with facilities for a company of 200 players. The stage of the theatre unit will also be the stage of the main auditorium and has a proscenium arch of 72 ft. span, a depth of 48 ft. and an overall width of 108 ft. Fly galleries are to be done away with, and nothing but modern stage-setting machinery used.

To the north of the arena will be located another complete unit of the same approximate size as the theatre unit on the south. The northern unit will be

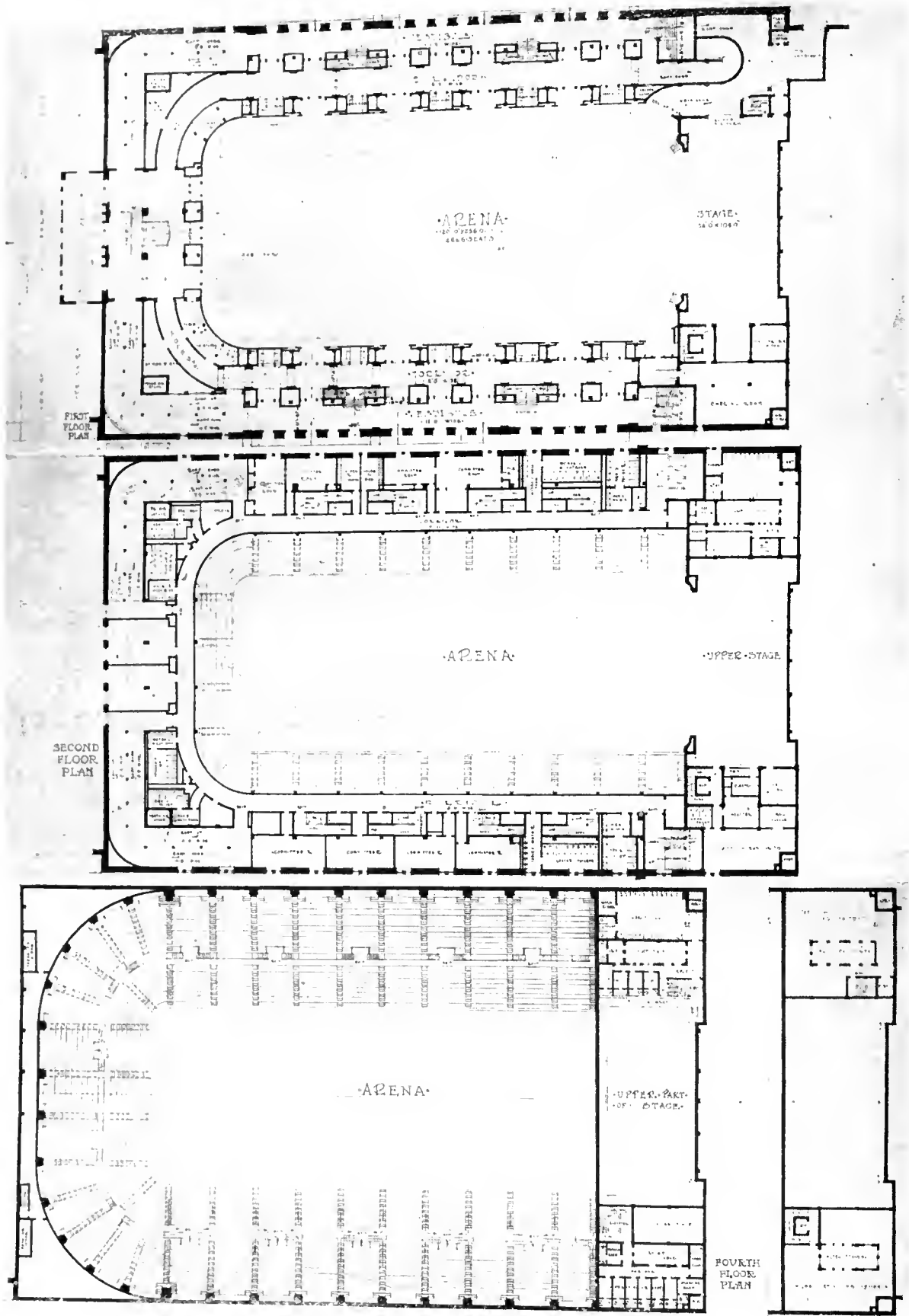

FLOOR PLANS OF THE CLEVELAND AUDITORIUM
J. H. MACDOWELL, ARCHITECT. F. R. WALKER, CONSULTING ARCHITECT

THE AMERICAN ARCHITECT

six stories in height and will include the formal lobby and some twenty convention halls, with seating capacities ranging from 300 to 1,200.

Curving runways will be built from the basement to the arena floor to take care of circus parades and pageants. It is stated that the Cleveland public hall will be able to take care of a much bigger circus audience than Madison Square Garden in New York City.

Two great steel derrick towers, movable on wooden trestles, played an important part in erecting the framework of this structure. The four trestles, two for each tower, were built within the side walls, and parallel with the longitudinal center line of the building. Upon these trestles the towers were built. On top of each tower was erected a large derrick, operated by a hoist at the tower base. The most difficult task handled by the towers was the placing of the roof trusses, each over 200 ft. long and weighing 200 tons a piece. They were put in place without trouble, however. As riveters went to work on one,

the cables were removed from the derricks and anchored to the ground. The hoists then pulled themselves and the towers rearward, into position for lifting the next truss. The bottom chord of each truss came in seven sections. In placing these the center section was laid first, after which the other sections were connected and wedged up to proper elevation. When the complete chord had been bolted up and connected to the wall columns, all web members were set and finally the top chord (shipped in four sections) was set in place. The truss was then riveted complete and swung by cutting loose the blocking.

It is planned to complete the building by October 1, 1921. The total cost will be approximately \$5,000,000. The building was started during the administration of Mayor Davis and will be finished under the administration of Mayor Fitzgerald. Floyd E. Waite has served as Director of Parks and Public Property during these administrations. F. H. Betz has been succeeded by J. H. MacDowell as architect. F. R. Walker is the consulting architect.

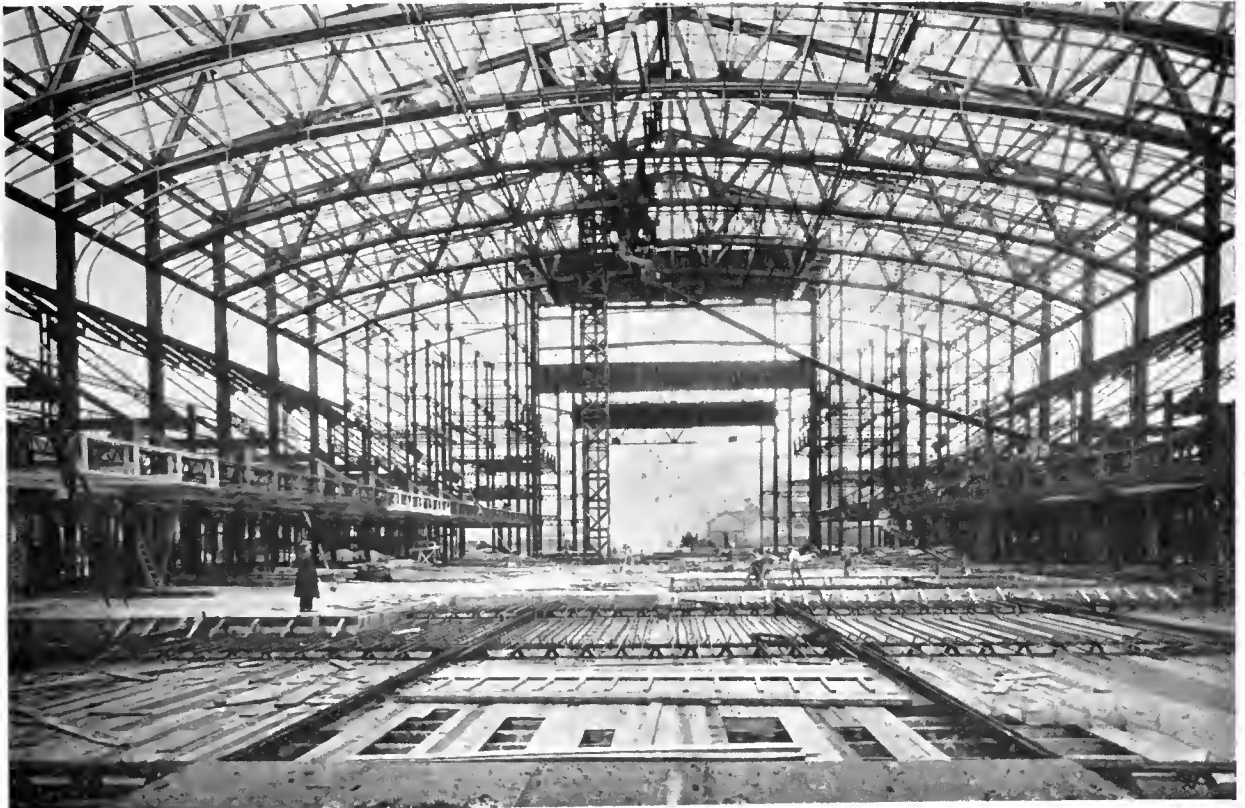

A VIEW FROM THE MAIN FLOOR DURING STEEL ERECTION

An Improvement in Hollow Tile Floor Construction

By ALLAN F. OWEN, M.W.S.E.*

THE use of hollow tile floor arches was coincident with the erection of the first steel frame buildings and until the introduction of reinforced concrete it was universally used. The first arches to be used were of the segmental type. The fireproofing of the tie rods was an item of considerable expense and rather unsightly in appearance, the plastering of the ceiling was costly and

voussoirs are standard for each depth of arch, the skewbacks vary with each depth of supporting floor beam and the keys vary with the length of the spans. The function of the key is to close the arch which is built towards the center from each supporting beam. It will be seen that in a building in which several depths of floor beams are used and several span lengths occur, there are quite a number of spe-



INTERIOR VIEW DURING CONSTRUCTION, OLD COLONY LIFE BUILDING, CHICAGO, ILL.

Note ceiling, showing an excellent surface for plastering, also small amount of debris

the finished appearance unsatisfactory. In buildings of the better character a suspended ceiling was used in order to secure a flat ceiling, thus entailing a considerable added cost. The rise of these segmented arches was generally one inch per foot of span.

A later development was the flat arch, the first of which were of the side construction type, succeeded by the better end construction type. A flat arch is made up of skewbacks, voussoirs and a key. The

cial tiles which are expensive to manufacture and are conducive to confusion in sorting, distributing and placing. Every tile in this type of construction has some feature which adds to the cost of its production. These arches range from ten to sixteen inches in depth and are generally set with a three-quarter inch camber. On striking the centering the mortar joints adjust themselves in such a way that the ceiling becomes practically level. This type of arch is very satisfactory for steel frame buildings.

*Structural Engineer, Marquette Building, Chicago.

THE AMERICAN ARCHITECT

Economy in construction is secured by decreasing the cost of materials and labor. In making a study to develop a less expensive type of flat arch construction attention was first given to the materials. The cheapest hollow tile material is that known as partition tile which have rectangular sides and square ends as opposed to the radial joint ends of the voussoir tiles. Partition tiles are made in full and half lengths, twelve and six inches long respectively. It is obvious that a floor constructed with standard partition tile, soffit and channel tiles would be economical as to the tile material. The next element to be considered was labor. If the arch could be constructed of medium weight pieces and placed without the necessity of making accurate closures in each arch, a labor saving would be effected. The elimination of the usual three-quarter inch tie rods would also make a saving of steel and in the labor of fitting the tile about them. The cost of centering would be the same in both cases.

These factors were embodied in the design of the floor arches installed in the Old Colony Life Insurance Company building now being erected in Chicago. This building is located at 168 West Jackson Boulevard and extends through the block to Quincy street. The building was designed by C. A. Eckstorm, architect, the fireproofing erected by the T. G. Nicholson Company and the writer was structural engineer for the floor construction.

In constructing these floors an 8 x 12 x 12 in. partition tile was used in full and half lengths. The tile was laid on its eight inch face making the depth of the arch twelve inches. Two rows of tile were laid from beam to beam with cement mortar joints be-

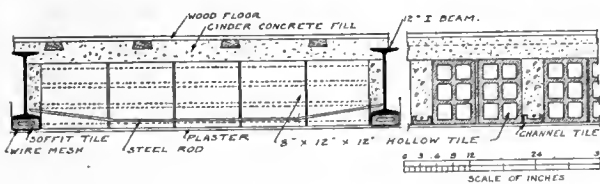

DETAILS OF FLOOR CONSTRUCTION

tween all adjoining surfaces. Between these two rows of tile was placed a four inch channel tile and the space between the partition tiles filled with concrete in which was embedded a $\frac{3}{8}$ -inch steel rod as shown in the design. The partition tiles were laid from the center of the span to the supporting floor beams and the skewback closure made with concrete, poured with the concrete joists and thus surrounding the tile construction with monolithic concrete on ends and sides. No provision was made to prevent the slight inflow of concrete into the tiles at the skewbacks. This was inconsiderable owing to the size and shape of the cells but is an appre-

ciable element of strength. The soffit tile under steel floor beams had a metal fabric under it and extending up into the concrete skewback as shown. This provided a most effective anchorage for the soffit tiles.

The four inch concrete joists and the $\frac{3}{8}$ -inch steel rods were largely a concession to the Chicago Build-



VIEW SHOWING CONSTRUCTION OF FLOOR ARCHES

ing Department requirements. Some few panels have been constructed with two inch concrete joists with no apparent differences in strength. When tested under the supervision of the Chicago Building Department with an applied load of 900 pounds per square foot, no deflection was indicated by the gauge. The first arches were laid with a three-quarter inch camber but no settlement took place when the centering was struck twenty-four hours after the arch was laid. The balance of the arches were laid with an one-eighth inch camber.

The fine level ceiling surface secured for plastering is indicated in the illustration on the opposite page. The installation was made with unusual speed, the contractor being compelled to stop work two times to enable the steel erector to get ahead of him.

An interesting comparison of cost was made recently between a long span combination tile and concrete system of floor arches and this new short span system is a sixteen story steel frame building now under construction. Three steel floor beams were added in each bay for the short span system and this cost of steel was more than compensated for by the cheaper erection cost of tile and its erection, less reinforcing steel and yardage of concrete. The total dead load was slightly less for this system.

The advantages of this system are those relating to cost and speed of construction. The elimination of the radial jointed voussoirs, special skewbacks and

keys, resulting in the use of from seven to fourteen different shapes, and the substitution of standard full and half length partition tile, standard one-size soffit and channel tiles reduces the cost of manufacturing, transportation and handling and obviates the delays due to the wrong distribution of the sizes at

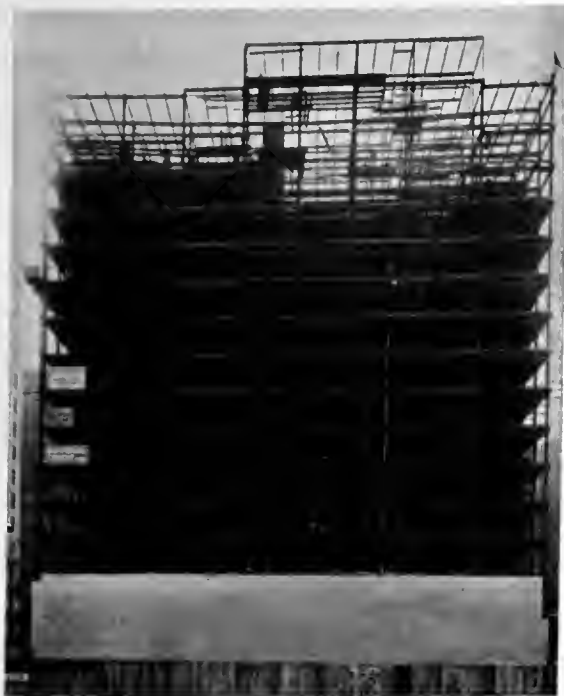

CONSTRUCTION VIEW, OLD COLONY LIFE BUILDING, CHICAGO, ILL.

the building and simplifies the work of the tile setter. Patents have been applied for covering several features of this system of construction.

[Among the several departures from the usual types of building construction made necessary by the cost or scarcity of materials and labor, the above article describes an interesting improvement in methods. It also is one more indication of the facility with which plastic concrete can be used in connection with materials difficult to alter after manufacture. It is evident that the use of concrete in combination with other materials offers a field for further investigation and invention. In this case, Mr. Owen, who has had an extensive experience in the manufacture and use of hollow tile wares, has made a notable improvement in methods of hollow tile construction.—The Editors.]

Not Educated Up to Sprayer

That architects may oftentimes be shortsighted is indicated by the following instance, which came under our observation:

A local painting-contractor had a contract for the painting of the large steel trusses of an auditorium. In this work he contemplated the use of an air sprayer as being more efficient for that type of work than brush work. The architect, learning of that intention, notified the general contractor that since the specifications did not state that a sprayer might be used, forbid that method, claiming that it was impossible to get the paint into the cracks and crevices.—December Bulletin, Associated General Contractors of America.

[Editor's Note:—The subject of Spray Painting was treated very fully in the June 23, 1920, issue of THE AMERICAN ARCHITECT.]

A Correction

Reference is made to a photograph of the Plaza Hotel on page 713 of our issue of December 1, 1920. This was in error attributed to Warren & Wetmore as the architects. Mr. H. J. Hardenburgh was the architect of the original building, while the addition is the work of Warren & Wetmore.

Publications Received

The Atlas Portland Cement Company has just published "The Atlas Handbook on Concrete Construction." This book is bound in cloth, and contains 144 pages, 4" x 6½", of solid information on concrete mixing, reinforced concrete, concrete forms, concrete building construction. The information contained in this booklet is well illustrated by 135 pictures and 40 tables. It is classified for ready reference in both a Table of Contents as well as an alphabetical index.

The chapter on concrete mixing gives valuable tables, information on methods and tests, etc. This is followed by a discussion of reinforcements, taking up beams, girders, floor slabs, etc. Bending steel reinforcements receive considerable attention. The discussion of the building of typical concrete forms is good.

Current News

Happenings and Comments in the Field of Architecture and the Allied Arts

Small House Competition for Architects

Mr. Henry K. Holsman, president of the Illinois Chapter of the American Institute of Architects and architectural adviser to the "Own Your Home" Expositions to be held in New York City and Chicago early next year, is sending to architects the general program for a "Small House Competition" which is to be conducted in connection with these two events. The Chicago exposition, as previously announced, will be held March 26 to April 2, 1921, while the New York City exposition opens April 16 and closes April 30. In explaining the purpose of this "Small House Competition" Mr. Holsman, in a letter to architects, says:

"The American Institute of Architects realizes that the architectural profession and the services it can render to society are not properly appreciated by the people, greatly to the detriment of the profession and the community.

"The architectural profession has not received as much public recognition as other professions because it has not hitherto performed as much public service. The logical way to keep the value of architectural services in the minds of the people is to do some conspicuous public good.

"The country is now confronted with a lack of private initiative in home building and home ownership. The government is beginning to realize that homeless citizens and families, whether rich or poor, are not potentially the best citizens—that every additional home owner makes an additional credit possibility, an additional property security to the nation's wealth, and an additional urge for all other forms of permanent construction.

With a view to stimulating home building and home ownership, "Own Your Home" expositions have been inaugurated to be held in various large centers to show the people the value of a good home and how to obtain it. Realizing that the majority of homes are not designed by the most competent architects, and that small house plans are not usually profitable work for the established architect, the architects will make their contribution to this movement at present in the form of a Small House Competition, program of which is herewith enclosed.

"You are invited to participate in this movement

and send in the best solution of the small house problem that can be devised for your particular locality.

You will notice that the cash prizes to be awarded are considerable, and that the other prize conditions are more important to the architectural profession. The plans securing the prizes will be widely published, will be made available, complete with specifications ready for execution, at small cost to home owners, architects and builders. These plans will bear the architect's name and address so that he may receive not only compensation for every reproduction of his plan, but may be placed in contact with the builder. Furthermore, arrangements are being made to reproduce the first-prize designs in the exposition in facsimile and other prize designs in small models. One large house-furnishing store has offered to reproduce the prize designs in full size, furnished and decorated, in their store and it is expected that other stores throughout the country will do similar service.

"We trust that you will consider this matter of enough value to yourself, the profession and the public to prepare and send a design which will be the best that your combined office force can produce. If you cannot participate, will you be kind enough to hand this program to some draftsman who would be competent to participate."

The program may be had by addressing Mr. Holsman at 175 West Jackson boulevard, Chicago.

New York Society of Architects

This society held its regular monthly meeting Tuesday evening, Dec. 21, at the United Engineering Societies Building, West Thirty-ninth street, New York City, President James Riely Gordon in the chair. A full quota of members was present, and great interest manifested in the various important topics discussed.

A communication was read from the chairman of the Board of Standards and Appeals, in regard to the proposed rules requiring rat-proofing of buildings along the river fronts. After somewhat extended discussion, in which the element of humor was not lacking, the meeting, on motion by Mr. H. Holder, passed a resolution that "the society is opposed to the structural requirements under consideration before the Board of Standards and Appeals,

and that this matter can be more effectually dealt with by the Board of Health, each individual householder co-operating." The discussion led to the conclusion that the good accomplished as applied to existing buildings, would not warrant the expense involved, and that there are simpler and more economical expedients, such as wire netting applied to sewers, which are largely infested by rats; the filling in with broken glass or concrete between studs of partitions, and closing up runways of these vermin, which would suffice to meet the emergency. At the same time, as regards new buildings, the proposed additional precautions might, if only in a modified form, be adopted.

In response to an inquiry from a member as to whether a corporation can practice architecture under the title of Registered Architect, the information was elicited that such practice is illegal, since the title of R. A. is conferred only upon individuals, and a corporation, even though employing registered architects, may not assume such title.

President Gordon asked for suggestions from members which might assist Senator Dunnigan's Housing Committee, and the discussion brought out the general opinion of members that reforms are necessary in the practice of dealers and manufacturers refusing to give price quotations to architects or their clients. It was pointed out that corporations doing business in the state owe a duty to the public, by whose sufferance they are permitted to do business as such, and such corporations should be placed under a legal obligation to sell to any bona fide customer at a fair market price. Material men and dealers at present will not quote prices to anyone except contractors in their particular or affiliated line. This ignorance of costs prohibits the architect from giving a comprehensive estimate to prospective investors, entailing a loss of prestige and confidence in the architect. Another point brought out was the wasteful methods encouraged by the rules of the labor unions, which make necessary a great deal of work in the field which could be done in the shop at half the cost.

The idea of the open shop was strongly favored by the meeting, as being thoroughly American, and in accord with the principle that the right to work shall not be denied to any man.

The Society deplored the fact that there does not appear to be a man in public life who has courage to uphold the right of the individual as against combinations, whether of capital or labor. This same principle of class interest appears to dominate the commercial life of the community, to the grievous limitation of individual liberty.

Severe comment was also made upon the fact that architects as a class have been the chief sufferers from the conditions which have prevailed for some

time past. The term architect in its original and strictly correct meaning signifies Master Builder. As such the man who bears that title ought to be able to control all classes and interests included in the domain of building construction. As a matter of fact, however, the architect is held to be of little account in these days, and as to compensation for his services—essential to the welfare of the community as those services are—he is probably the most poorly paid of all professional men: the average employee in an architect's office receiving perhaps about the same pay as a common laborer on the building he designs and superintends.

A 2,000-Year Old Definition of an Engineer

In a recent address before the Western Society of Engineers, Mr. John W. Alvord, past president of the society, gave a definition of an engineer made by Marcus Vitruvius, who wrote 150 years B. C.

"He should be a good writer, a skillful draughtsman, versed in geometry and optics, expert at figures, acquainted with history, informed on the principles of natural and moral philosophy, somewhat of a musician, not ignorant of the sciences, both law and physics, nor of the motions, laws and relations to each other of the heavenly bodies. * * * Moral philosophy will teach him to be above meanness in his dealings and to avoid arrogance. It will make him just, compliant and faithful to his employer, and what is of highest importance, it will prevent avarice gaining an ascendancy over him, for he should not be occupied with thoughts of filling his coffers, nor with the desire of grasping everything in the shape of gain, but by the gravity of his manners and a good character, should be careful to preserve his dignity."

The Architectural League of Indianapolis

The Architectural League of Indianapolis is a new organization based upon that of the Architectural League of New York City, with some changes that were considered necessary to adapt it to local conditions.

Charter membership is still open as it is hoped to reach everyone personally who might be interested or benefited by an organization of this character.

It is the purpose to bring about a closer association and co-operation of the architects, sculptors, landscape architects, draftsmen, painters, decorators, and all the allied artisans.

Arrangements have been made whereby the League will have use of lecture and class rooms at the John Herron Art Institute. The League is responsible for the local atelier of the Beaux-Arts Institute of Design, which has a following of about thirty-five students. Courses have been arranged in Architecture and Interior Decoration. Beginners will have a special class to train them in the elements of design to prepare for Beaux-Arts problems.

An interesting course of lectures is planned for the winter. Several small exhibitions will be held and later it is hoped that some large exhibition of local work may be arranged for and advantage taken of some of the large traveling exhibits.

The League is a post-war effort to revive interest in artistic organization and to increase public appreciation of the arts. All lectures are open to the public. The secretary of the League would be glad to correspond with other organizations, for the purpose of exchanging ideas which would be of mutual benefit, and to learn of possible lectures and exhibits.

Billions for Construction in 1921

Early resumption of home building and other forms of construction is assured if reports of contemplated building projects may be taken as a criterion for the coming year.

These reports show that contemplated building projects for the territory north of the Ohio River and east of the Missouri will probably reach the tremendous amount of \$4,800,000,000, which under normal conditions would indicate actual construction during 1921 of approximately \$3,200,000,000.

The low lumber market now prevailing paves the way for a big reduction in building costs. Thousands upon thousands of homes, so badly needed, will be built under these conditions. This will necessarily call upon thousands of men from all trades for the production of building materials.

Such demands will naturally lead to steady production and universal employment which in turn will make for better business activity and general prosperity.

Largest Concrete Building

The largest concrete building yet erected on Manhattan Island is now being built at 395 Hudson street, New York. The building, partly an 11-story office building and warehouse and partly a five-story and basement warehouse, will occupy the entire block surrounded by Hudson, West Houston, Greenwich and Clarkson streets. The construction will cover an area 338 by 200 feet and will be throughout of reinforced concrete with the exception of a veneer of brick on the exterior walls. McKenzie, Voorhees

& Gmelin are the architects. The work is being done by the Turner Construction Company.

This operation furnishes a most interesting side light on the trend of building design in the greater city. For many years it has been an accepted fact that reinforced concrete was an ideal building material for industrial buildings, but loft buildings, apartment houses, office buildings and institutional buildings have still been built almost exclusively of structural steel, brick, stone and terra cotta. With the present labor and material price situation, the economy in favor of reinforced concrete is so big that many people, who through prejudice or inertia, had refused to consider reinforced concrete, are now turning to this material as the only way out of their difficulties.

The building is of a type which up to a year or so ago, would have been built of structural steel. Today it is going ahead, the largest building of its kind, or reinforced concrete without any structural steel involved at all. There are many office and loft buildings, twelve stories or less in height, which could be efficiently, economically and expeditiously built of reinforced concrete at this time. This building will be occupied by the Western Electric Co. and the New York Telephone Co.

The American Standard of Living

Much is said about an American standard of living, remarks the Boston *Transcript* editorially. Much is said of the necessity of minimum wage scales in industry. It is time that there should be some well-formulated ideas as to what constitute an American standard of housing, especially in the congested districts of the great cities. Of what avail is it to erect hospitals and maintain clinics for the treatment of the sick if disease is to spread and multiplied in its extent by the overcrowding of tenements? How much permanent good will follow efforts at combating vicious tendencies in city life, if many thousands of city dwellers are deprived of any semblance of decent privacy in their living quarters, and if the lure of the streets is enhanced by the lessening of home accommodations, already, in many cases, pitifully inadequate?

It is questions such as these that are evidently making strong impression upon the minds of judges who hear cases involving the meaning or the validity of laws passed during the present crisis. These laws are emergency measures. But back of them is the fact that, while there may be only temporary need of drastic measures such as have recently been enacted, there is urgent and permanent need of the maintenance of an American standard of housing, in accomplishing which a well-considered and reasonable body of law, of course, will be essential.

Personals

Charles K. Cummings, architect, is located at 8 Beacon street, Boston, Mass., formerly of 6 Joy street, that city.

W. D. Johnson & Co., architects, have changed their firm name from Johnson & Burns to the above. They are situated at 174 Bond street, Hartford, Conn.

Bruno Wozny, architect, formerly located at 381 Main street, Springfield, Mass., has moved to 94 State street, that city.

Marshall J. Smith, architect, has opened new offices at 411-412 Oxford Building, Washington, D. C.

William C. Noland, architect, has become located at the Old Dominion Trust Building, Ninth and Main streets, Richmond, Va. Mr. Noland formerly was a member of Noland & Baskerville, architects, of the same city.

Simpson & Githens, architects, moved from room 833, Reibold Building, Dayton, O., to room 869 of the same building, for the larger quarters the latter affords.

News from Various Sources

Of the 110,000,000 citizens of this country, 45,000,000 are physically imperfect, 15,000,000 die annually, 3,000,000 are in bed all the time, and 1,000,000 have tuberculosis. Only 37,500,000 are fairly healthy, and only 19,500,000 are in full vigor. There are more persons in the insane asylums in this country than in the colleges and universities, and it costs more to maintain the former than the latter.

* * *

The Illinois Legislature will be asked to provide a total of \$8,000,000 for the new state hospital in Chicago. A million dollars have already been appropriated, the foundations have been laid and bids are being received for the construction. Frank I. Bennett, director of public works for the state, has the matter in charge.

* * *

The new Ambassador Hotel, at North State and Goethe streets, is scheduled to open in mid-December. A legal dispute is now being waged as to the use of the name "Ambassador." The Hotel Sherman Company owns the new Chicago hotel, and the Ambassador Hotel organization objects to the local use of the name.

Interest in the "Own Your Home Exposition," to be held at the Coliseum, March 26 to April 2, is increasing. Practically all exhibition space has been sold, it is announced.

* * *

Addressing itself to the proposition, "Is Chicago a Jay Town," the Chicago Tribune says editorially: "Architecturally we are anarchy, lacking the unity and harmony and high standards which stamp with character all the great cities of the world—even nouveau New York."

* * *

Sweden may spend \$2,500,000 to establish wireless communication with the outside world, especially with the United States.

* * *

The largest industrial eating place in the world, capable of feeding 3,100 persons at one time, is operated at the Westinghouse plant in Pittsburgh.

* * *

President Wilson's annual message, transmitted to Congress Dec. 7, recommends revision of tax laws, economy in Government, a "workable" budget system, a loan to Armenia, independence of the Philippines, rehabilitation and training of disabled soldiers and efforts to reduce cost of living.

* * *

Senate, Dec. 7, received and referred approximately 17,000 nominations, chiefly those made during recess of Congress. They included officials of all ranks and about 15,000 army nominations.

* * *

Senator Knox, for Senator McCormick (R.), Dec. 7, introduced a bill reorganizing the executive departments and various Federal agencies.

* * *

Senator Kenyon (R.), Dec. 7 introduced a bill to create a department of public welfare.

* * *

Representative Rogers (R.) introduced a bill, Dec. 7, providing for co-ordination of functions of War Risk Insurance Bureau, Public Health Service and Federal Board for Vocational Training to be combined in a bureau of veteran re-establishment of Interior Department.

A Correction

In the article on Post-War Housing in our issue of December 22, page 817, it was stated that only about three per cent. of all building in this country is designed by architects. This is a typographical error, as the correct amount in value should be 73 per cent.

In our issue of Dec. 15, page 787, the President of the Cleveland Cliffs Iron Co. should have been noted as W. G. Mather. Mr. George W. Maher was consulting architect.

frontispiece to 2351

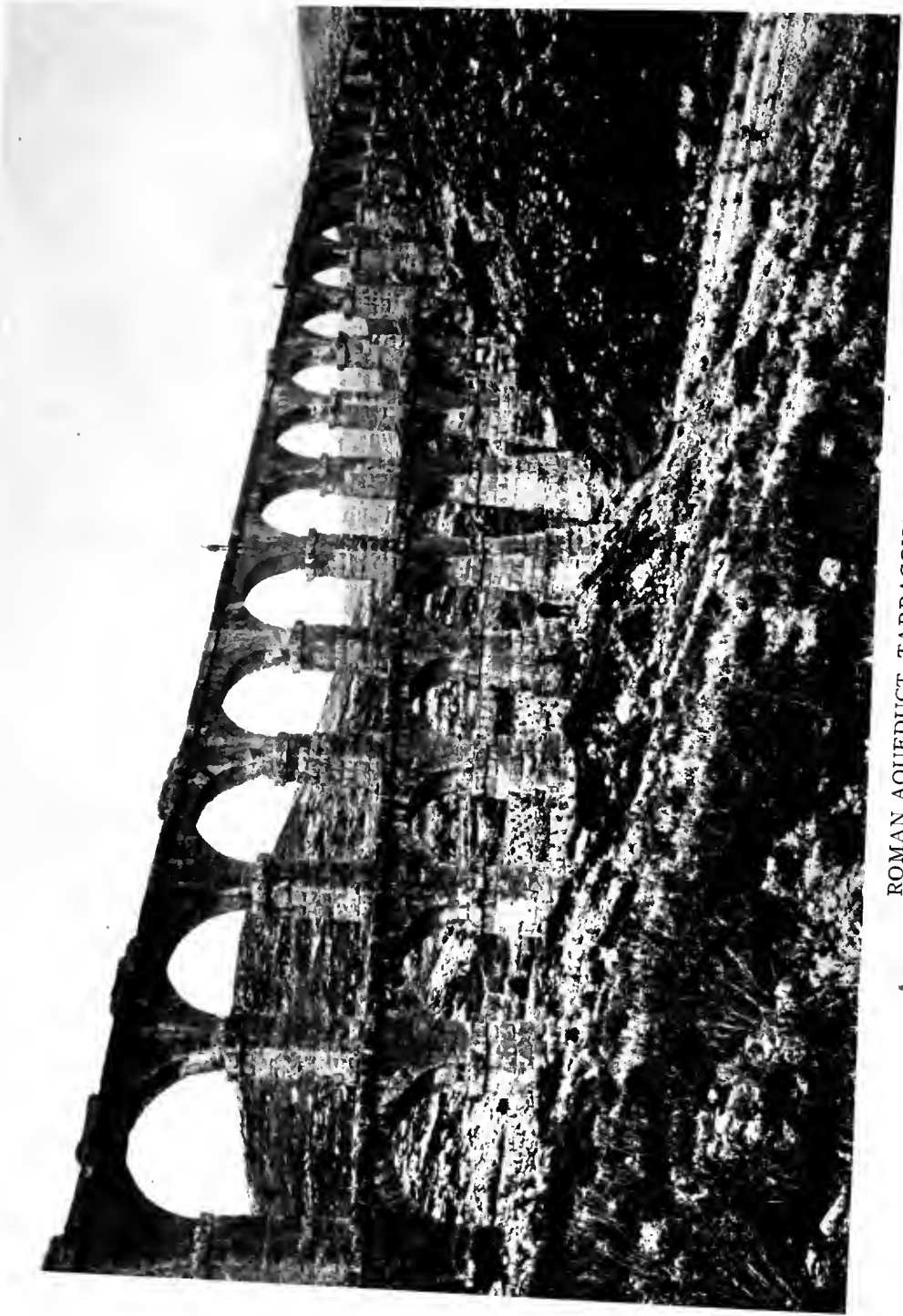

ROMAN AQUEDUCT, TARRAGONA, ITALY

THE AMERICAN ARCHITECT

THE AMERICAN ARCHITECT

VOL. CXIX

WEDNESDAY, JANUARY 12, 1921

NUMBER 2351

War Memorials

Impressions of an Interview with Cass Gilbert, Jr. (Who Served As Second Lieutenant, 17th Field Artillery, 2d Division, A.E.F.), in Which Mr. Gilbert Comments on War Memorials Generally and the Proposed New York State Memorial Particularly

WHAT form should a war memorial take? In that question is summed up a vast amount of contention which has seriously affected a substantial portion of our population since the signing of the Armistice and which remains today as far from a satisfactory solution as it was at the very beginning of that period when war memorials came seriously to mind with so large a part of the nation's population. There appear to be two schools, the one believing purely in beauty which will inspire the ideals for which the Army and Navy fought, as opposed to utility; the other in a combination of the two. Both schools have in mind the commemoration of an ideal or ideals. Those who speak for utility do so in relation to the community as a whole, and usually have in mind such ideals as citizenship (Americanization programs, for example), fraternity, democracy and the benefits which are offered the living through such a medium as the proposed Victory Hall or similar types of community centers. They believe that the commemoration of ideals can go hand in hand with any sort of memorial designed primarily with a view to utility, and that the spirit with which the men fought and died can be most appropriately remembered and cherished through the medium of utility which seeks to benefit, and materially better, the citizenship of any community, large or small.

To these contentions serious objections were raised.

"A war memorial," Mr. Gilbert explained, "should be so designed and executed that it gives one impression only, and that impression should be one of sheer beauty, strongly suggestive of the ideals for which the memorial stands; namely, Courage, Bravery, Liberty and Victory. It should be thought of only in relation to those who were most actively and intimately engaged in the war. I am speaking of those who not only gave their lives on the field of battle, but of the men and women alike who gave

themselves entirely to the aid of the Government in helping the men on the battle line.

"With those basic principles in mind, it is difficult to understand how anything other than the strictest interpretation of a memorial would suffice. The so-called utility which has been spoken of is not at all fair to the men who fought. Think of a so-called Community Center, Public Hall or other utility which should perhaps, on its own merits, be provided by the community in the normal progress of its development as opposed to a magnificent monumental memorial, and analyze the value of the two. The community idea, expressed by such a structure, would not be used to any great degree by the men most concerned with it. It would not be enough merely to provide some sort of 'forum' where people could meet to further citizenship. Supposing even that the scheme worked as contemplated, and that the 'forum' proved its worth as anticipated. What of it? What would there be in that to remind people in future years of the ideals for which men fought and for which men and women alike gave their all?

"Practically nothing. A public gathering place in New York, regardless of its beauty, does not inspire much reverence, or idealism, or thoughts of the past as related to the future. The city is too huge. There are too many other buildings. Such a memorial would not stand out; it could hardly make itself felt so effectively as a detached memorial.

"That, in a general way, is true of all cities. There is only this difference, that in New York it loses its purpose because of the city's hugeness, and in smaller cities or towns it becomes commonplace, regardless of its beauty. Commonplace because it is, after all, merely another building, another public gathering place. Sheer beauty of the structure cannot take away from the fact that it is designed primarily as a common meeting ground for the community; and there are few persons idealistic enough to detach

THE AMERICAN ARCHITECT

themselves from a gathering and think of the place where it is being held as a commemoration of an ideal. And if they cannot do so, the memorial is a failure, because any memorial should be a symbol of the splendid achievements of the past in relation to the actions of the present or future. Its purpose is retroactive.

"There is another objection to the community center scheme which seems to me a very serious one. Utility is usually the pallbearer of idealism. It is necessarily a fact that utility in itself implies the subordination of sheer idealistic beauty, else such beauty would be considered alone in the first place. I do not mean that beauty and utility cannot exist side by side, but I do mean, most emphatically, that if a memorial is considered from the utilitarian point of view, every other element of the scheme must necessarily be thought of in its proper relation to utility, and not to beauty or to the interpretation of an ideal.

"Such a viewpoint holds true for all who enjoy the privileges of any utilitarian memorial. The thing begins as a building consecrated, so far as it is possible to consecrate it, to an ideal; but in a very short while it becomes a building and nothing more. Whatever idealism may have existed at the beginning gives way to thinking of that memorial as a building where one may go, precisely as one goes to a hotel or theatre or other public place.

"Idealism, or the commemoration of idealism through the medium of any community scheme, which is after all merely a gathering place for people, inevitably gives way to thinking of that scheme of commemoration primarily as a gathering place, and *nothing more*. Consider Carnegie Hall as an example. People go to Carnegie Hall with no thought of Andrew Carnegie, and the name has become merely an address rather than a memorial."

"There are purely material objections as well, are there not?" the writer asked Mr. Gilbert.

"One particularly suggests itself at the moment," he replied. "Death will reduce the ranks of the American Legion or other patriotic organizations to whom a memorial is built. As they become fewer and fewer, it becomes a harder matter to support the memorial, to furnish funds for its continued existence. It falls into a slow and gradual decay. It is sometimes lost entirely and goes its way under the auctioneer's hammer.

"Now, this is not a guess or a prophecy. It is based on fact. Precisely that has happened to certain 'memorials' of the Grand Army of the Republic. It is also based upon observation. Consider for a moment how difficult it is to raise money with which to buy or support the homes of our great men in this country. Isn't that a fact? Is it not

true that, if any society or group of citizens sets out to buy the home of a former president or other public figure, it is not at all an easy matter to get the money with which to carry out their intention? Does money pour in upon them with a mere mention of their plan? Not at all. They must *campaign* for it, even if the home to be bought was once that of a well-known and very much loved public figure, such as 'Monticello,' the home of Jefferson.

"Now, how much more difficult would it be to maintain a war memorial dedicated to no one in particular, but to an ideal? What chance would it stand of being saved from sale for commercial purposes, if the community found it to be a matter related definitely to taxes or to assessments of some form or other? Suppose the Memorial Hall were endowed. How many endowed funds have come down to us from ancient times? We are suggesting this memorial not for the present (the present knows and will remember), but for the future so that our descendants may know what this generation did for the country in the Great War."

"What sort of memorial, then, would you suggest?"

"The idealistic sort, the purely beautiful sort, which would most certainly serve the community with its idealism and its beauty, but which could not possibly be confused with a public gathering place in the sense that a building would be so confused.

"There are innumerable sorts of such memorials. Arches, monuments, symbolic statues, and so forth. In its planning and execution I would like to see a close co-operation between the architect and the sculptor. If it were to be set by itself, apart from any but a natural background, and not as a part of a structure, it may become then a matter more for the sculptor alone; but this is dependent upon its extent and importance; and where planning is required the services of the architect are essential. If it is to be a structure—arch, monument or the like—in which the sculptor will contribute his share, I believe the architect should have complete supervision of every detail, so that whatever the sculptor produces will fit into the structure and not the structure into the sculptor's work.

"As an example of a very appropriate memorial, let me cite a proposal for New York. A splendid memorial for the state could be erected at Fort Wadsworth, facing the Lower Bay. It is very nearly the last bit of land one sees in leaving these shores and the first on coming in. There an impressive memorial could be erected that would impress beauty and idealism and nothing else. A monument in this location would inspire our fighting forces to stronger efforts as they sailed out to war. It would be seen by the thousands who go in and out the bay, whether to or from foreign ports or to the recrea-

THE AMERICAN ARCHITECT

tion centers along the neighboring coasts; and, in fact, its environment could be made a park of great beauty, available to the people. So situated it would not rival the Statue of Liberty further up the bay, but would reinforce the ideal for which it stands. In some appropriate place it would have the name of every New York man who took part in the war as a soldier or sailor."

"But why not place it somewhere on Fifth Avenue?"

"There are various reasons why that could not be done, on Fifth Avenue itself. One of the most pertinent, I believe, is that there are only a very few streets in all the world along which troops may march properly, and Fifth Avenue is one of them. Anything, however small, placed in the Avenue would naturally break that wonderful straight stretch for marching. Troops would have to go around a column of any sort, and that would spoil the effect of any magnificent parade.

"The traffic signal towers to some extent already constitute obstacles to effective marching of troops on parade. These towers can readily be removed, however, for such parades as would march up Fifth Avenue. This was done in 1919. A permanent monument could not be removed for a parade, nor would it be desirable to remove a memorial to Victory for a Victory Parade.

"Secondarily, the matter of scale must be taken into consideration. A monument for such a purpose should be the dominant and unrivalled feature of the location in which it is placed. Where on the Avenue do you find any considerable number of buildings less than five stories in height? Where, except at its upper end, could you put up a suitable monument or arch which would not necessitate the tearing down of expensive improvements?

"At Madison Square. Yes, the space exists, but what would the proportions of any monument there have to be in order to dominate the place? The Metropolitan Tower would dwarf anything less than 700 feet high, and even at that height, the eye would be taken up too much with the surrounding buildings.

"It may be urged that an arch would not obstruct marching troops. That is true, but it presupposes either that the arch should span a sufficient width to permit of 'columns of platoons' as wide as those in the parades of 1919, when the marching troops filled the full width of the avenue from curb to curb; or that the column formation should be changed to permit it to pass through an arch of smaller width. The narrower the columns of troops the longer it takes for the march past. The old Roman arches are far too small for a modern column to pass through. Moreover, there must be sufficient width for the piers and sufficient height

for good proportion. In any event the modern towers and skyscrapers would form an unrelated and unsympathetic environment for such a monument."

"Are there no other locations?"

"Yes, there are other fine locations. At 59th Street and Fifth Avenue, at the entrance to Central Park, for an example. Another fine site would be Mt. Morris Park, which is at the north end of Fifth Avenue. Here property could be restricted and building height limited at the present time so that a memorial situated on the rocky knoll would be the dominant feature of the section. Troops would march up to it and disburse around its base. It could be seen from way down the Avenue. The Washington Arch is at the south end of the Avenue, and what would be more appropriate than to have a memorial to valor at the north end of the Avenue? Other sites may be found, as, for instance, the heights at the northern end of Manhattan Island, where a memorial of sufficient size could be seen from way up the Hudson and from Long Island Sound."

"But the finest you believe to be the site near Fort Wadsworth?"

"I do. And incidentally, let me say that the theory that a memorial to a present achievement should go where the greatest number of persons can see it is not always correct. A monument should be as conveniently located to the center of population as possible, but it should always be located in a completely proper setting, with the right kind of background. There are very few places in New York City where a fitting memorial can be put up. Rather than risk a poor background, I believe in the more or less isolated location, so far as the center of population or the heaviest circulation is concerned.

"Grant's Tomb is an example of a memorial which is not at all centrally located, but which is most certainly visited by thousands of people who find it convenient to get there.

"I believe in people seeking the memorial, and not the memorial seeking the people."

Mr. Gilbert was then asked by the writer whether he believed it advisable to postpone the building of memorials for either definite or indefinite periods, until, as has been suggested by the advocates of postponement, "crystallization of thought takes place."

"Not at all," was his answer. "An ideal will not be more apparent nor finer ten years from today than it is at the present moment, because it is a basic and fundamental ideal: the maintenance of common justice. There is nothing about it which requires perspective, as the character and achievements of a man require perspective; and it is probable, if anything, that we could build a much finer and more fitting memorial at present than we could when enthusiasm has cooled.

"The fundamental ideals of civilization need no inquiry into the motives which prompted them, and therefore it is not necessary to wait for any 'crystallization of thought,' as there usually is in regard to the character or public services of an individual.

"The achievements of the present should be commemorated in the present. What the good men do is too soon forgotten. We are too much given to criticism of things present and praise of things past.

"There is one thing I wish to add," Mr. Gilbert

concluded. "Too much emphasis cannot be given it. Such a monument as we have been discussing is to memorialize a great event, and it is to honor those men and women who gave themselves and their substance to service. Is it not fitting, then, for those who served and who came through to determine the form, character and location of the memorial which shall be erected? The best is none too good, nor in the ranks of those who served is there lack of talent to create a fitting memorial."

A New Attempt by Labor to Organize Architectural Draftsmen

A Review of the Recent Newark, N. J., Controversy, with Impressions of a Conversation with One of the Most Prominent Architects of the Metropolitan District and Opinions of the Situation from Various Sections of the Country

EDITOR'S NOTE: *The architect quoted in this article, who requested that his name be withheld, is very well known to the profession throughout the country and in the Metropolitan District in particular. It was thought best by the Editor that no personal aspect be given to opinions quoted herein, and for that reason no names have been printed. A free and frank opinion of the situation has thus been obtained.*

THE recent attempt on the part of the Building Trade Council of Newark to unionize the architectural draftsmen of that city marks what might be termed a new policy on the part of organized labor.

There would appear to be three vital points at issue. First, what would be done in the case of architects who draw their own plans? Secondly, is there precedent for the formation of such a union? Thirdly, do the draftsmen themselves desire it?

As to the first point, one of the prominent architects of the country admits frankly that he does not know, nor does he believe the labor leaders of Newark know, what would be done about the small architect who draws his plans, and is therefore a draftsman.

"To intelligently grasp the situation it is necessary to review its brief history. Some time ago I received the following letter:

"To All Architects, Engineers and Contractors of Newark and Vicinity.

"Gentlemen:

"This is to inform you that Local No. 34 of the International Federation of Technical Engineers', Architects' and Draftsmen's Unions affiliated with the Building Trades Council of Newark and vicinity is actively engaged trying to better the material and social conditions of technical men. We are aware of the fact that all fair-minded employers of draftsmen and engineers are welcoming the advent of our union, which, it is hoped, will prevent further depletion of the ranks of technical men.

"Due to the unorganized state of the drafting departments, many employers, regardless of their desire to increase the wages and salaries of their technical staff, can not possibly do so without running into competition with employers who do not take the same view.

"To ameliorate this condition, Local No. 34 has been prosecuting for some time a vigorous campaign of organization among the draftsmen and architects in the building industry, finding full support in the Building Trades Council of Newark and vicinity, which at its session of May 14, 1920, passed a resolution, setting November 1 of this year as the date on which all the plans and drawings to be acceptable in the field, must be made by union architects and draftsmen, belonging to the International Federation of Technical Engineers', Architects' and Draftsmen's Unions.

"Trusting this information will obviate all possible misunderstanding in the future, and bring about mutual co-operation of all concerned, we are,

"Sincerely yours,

"WILLIAM LYONS,
"President Building Trades Council."

"Now, you will note that the letter is headed

"Technical Men of Newark and Vicinity (Local No. 34) International Federation of Technical Engineers', Architects' and Draftsmen's Unions.' That is a very important point, because the existence of the International Federation of Technical Engineers', Architects' and Draftsmen's Unions might be taken as precedent for the formation of a draftsmen's union here.

"The fact of the matter is this: On July 1, 1918, upon application of six local unions, which had been operating as units for some time, the American Federation of Labor granted an International Charter, under the title of 'International Federation of Draftsmen's Unions.' Subsequently, this name was changed to the present one. The reasons that brought about the formation of this International at that time were as follows:

"The marine draftsmen, then organized in several independent Unions, made an attempt to appear before the Shipbuilding Labor Adjustment Board (also known as the Macy Board) and to present a proposed classification for the marine draftsmen throughout the shipbuilding industry. Their appearance before this board was prevented on the ground that the Board could consider such matters only when presented by organizations that were representative national or international bodies.

"These several unions, realizing this fundamental weakness in their position, made immediate application to the American Federation of Labor for a charter. This application was tentatively approved about the 28th day of May, 1918, and recognized them as an international body, pending the granting of a formal charter on the date first above state. As an International of the A. F. of L., a hearing was promptly granted by the Macy Board. Sitting on this board of three was A. J. Berres, Secretary-Treasurer of the Metal Trades Department of the A. F. of L. The result of this hearing was that all marine draftsmen in Government, as well as in private employ, were granted a wage increase of about 36 per cent.

"Those facts are taken from a pamphlet issued by this particular Federation, entitled 'A Practical Organization: What It Is, What It Has Done.'

"Now, let me emphasize the fact that I believe the unionization of marine draftsmen in the Government employ or in private employ, or of draftsmen in terra cotta works, pipe factories, or the like, is a legitimate procedure. Everyone knows well enough that draftsmen in the Government employ could not get a hearing without organization of some sort. That is due to a multiplicity of reasons. Every one knows that draftsmen in terra cotta factories, or in factories of any sort where one finds about three draftsmen to three hundred union workers, are hopelessly out of everything unless they are affiliated with

some organization through which they can make themselves felt.

"Apart from that fact, however, is the very apparent one that the architectural draftsman is distinctly apart from the marine or even the architectural draftsman in the Government employ under civil service regulations. The architectural draftsman in private life has something ahead of him, for he looks forward to the time when he will become an architect himself and go into the open market in competition with other architects. The government employee, on the other hand (and this Federation of Technical Engineers, Architects and Draftsmen is composed principally of Government employees) looks forward to practically nothing. He usually remains a Government employee for the greater part of his life. He has little, if any, desire to get into the open market in competition with other draftsmen or architects. Hence he has need of some sort of organization through which he can make himself felt, or through which he can secure an audience with the powers that be."

The speaker paused for a moment and searched in his files for a letter, which he handed to the writer a moment later. It was an application for a position as draftsman by a man duly registered in New Jersey as an architect.

"There you have quite a problem," the speaker continued. "What is that man? Is he a draftsman or an architect? I look upon him as a draftsman because he makes application for a position as such and because architects as a whole regard him as such. But what does this proposed draftsmen's union term him? Supposing they *did* call him a draftsman? He comes into my office today, and is admitted into the union. Six months from today he leaves my employ, becomes an architect himself, and employs a draftsman. He then becomes an employer. What happens to his union membership? Unions don't want employers in their organizations, do they?"

"It's not the usual procedure."

"I should say it is not. Yet, that architect who draws his own plans is actually a draftsman, so far as the union is concerned, and the union seal would necessarily be placed upon all his works. Now, there must be some sort of fee for the use and privilege of the seal, and the small architect would be obliged to pay that fee precisely as would the draftsman employed by any architect. What would he be given in return? If he could not belong to the union he would gain none of its privileges. Is it exactly fair to ask a man to contribute something to a union without the slightest advantage to himself for that contribution?"

"But above all these facts there is a very vital point which seems to have been overlooked by the Building Trades Council," the speaker emphasized. "I

THE AMERICAN ARCHITECT

want to emphasize it, because I believe it to be the outstanding factor in the whole situation.

"The draftsman in our offices is the architect of the future. He is closely affiliated with the architect in all his dealings. Draftsmen are often delegated to inspect work, interpret drawings, and make decisions on behalf of the architect. It is therefore vital that the draftsman, if he is to render impartial service, shall not be affiliated with a labor organization.

"By the forming of a draftsmen's union, the employing architect is driven into an employers' association and the draftsman is enlisted on the side of labor. Under such circumstances, how is it possible for either party to make just and equitable decisions?

"It is important for the proper conduct of the building industry that there be one set of men who are *neutral*, to whom both the owner and contractor can look for just decisions. This body of men should be the architects and their draftsmen.

"If the organizers of labor would think for a moment they could readily see our point of view. It is for their advantage, and the advantage of society in general, that the architects and their draftsmen should not be affiliated in any way with either the owners, contractors, or labor, but be free to render just and impartial service in the future as they always have in the past.

"Furthermore, an organization of draftsmen and architects along labor union lines is wholly unsuited to a profession, and a fine art like architecture. We already have two societies in New Jersey, the New Jersey Chapter of the Institute and the State Society of Architects. Architects are admitted to both, and draftsmen to the latter. How much better it would be if all the architects and draftsmen in New Jersey joined the same society. We could then get together and discuss any problem and settle it to the satisfaction of all concerned. If the draftsmen cared to have an association as a side issue of the society, they could do so after they became members, and they would receive the fullest co-operation from the architects."

"Do the draftsmen care to become members of a union?"

"The best answer to that is summed up in the meeting of all architects and draftsmen of Newark and vicinity, held October 16, for the purpose of discussing this union, at which not a single draftsman could be found who in any way desired to become affiliated with such a union. This is a resolution unanimously passed at that meeting:

Whereas, The Building Trades Council of Essex County has notified architects, engineers and contractors that after November 1, 1920, "all plans and drawings to be acceptable in the field must be made by union architects and draftsmen belonging to the International Engineers', Architects' and Draftsmen's Unions," and

Whereas, The draftsman is the future architect in training for his profession, he being a part of the architect's organization, representing him in interpreting the drawings and specifications as a part of each contract, as such the draftsman necessarily being in the same position of neutrality in his decisions as the architect himself. Even the independent architect not being in a neutral position if his men were allied with the draftsmen's unions and he (the architect) allied with the employers, the contractors whose work he has to judge and control, be it

Resolved, That the architects and draftsmen here assembled do hereby agree to ally themselves with the New Jersey Society of Architects (if not allied thereto already) for the purpose of having a truly representative organization in which all questions affecting the interests of architects and draftsmen alike may be fully considered and equitably and fairly adjudicated.

"Have you ever attempted any inquiry into various sections of the country regarding this matter?"

"I have. These letters"—handing a thick batch of correspondence to the writer—"are answers to a circular I sent to leading architects in representative sections of the country. Not one of these answers indicates in any way that similar attempts at unionization of architectural draftsmen in private offices has been successfully attempted in any of the sections of the country to which the answers have reference. In other words, there has been no other such attempt.

"What is even more important, you will notice that the sentiment of draftsmen in the various sections of the country represented in those letters not at all interested in unionization, much less desirous of becoming members of a draftsmen's union."

Glancing through the letters, the writer noticed that from practically all sections of the country this sentiment seemed to prevail:

First, that no known effort (except in one or two unusual instances) has been made to organize draftsmen's unions in the states represented in the answers. Draftsmen in various states have been questioned regarding their desire to become unionized, and expressed themselves as against any such move.

Second, where any effort has actually been attempted to unionize the draftsmen, the movement has failed almost completely, so far as the architectural draftsmen in private offices are concerned. As one draftsman in a large western office expressed it: "I look forward to the time when I will practice for myself and, if for no other reason than this, I would not wish to affiliate with any labor organization."

Third, the draftsmen in a number of cities have expressed themselves emphatically satisfied with things as they are.

"Such is the sentiment in almost every section of the country. That being the case, I cannot see how the Building Trades Council can advocate

a draftsman's union on any sort of precedent whatsoever. It does not exist."

"But there is a local of the International Federation of Technical Engineers, Architects and Draftsmen's Unions in Newark, is there not?"

"Well, if the local exists, I can say pretty definitely

that I do not know of a single Newark architect or draftsman who is a member. That alone should indicate the feasibility or advisability of a draftsman's union in Newark. The letters I have showed you indicate its feasibility in other sections of the country. It is a local and national impossibility.

An Insight into Japanese Life

A JAPANESE house is one of the simplest things ever built for it consists of little more than four posts and a roof. But such impermanence, says the *New York Herald*, which is also seen in other things, is a part of the strength of the nation, for no people in the world have so few wants.

The Japanese have no bread, no beds, no fires, no boots or shoes, no trousers for the men, no petticoats for the women—for both sexes wear several dressing gowns, one over the other. In their houses they have no windows, no doors, no walls but paper shutters fixed in grooves, no ceilings, no chests of drawers, not even a washstand.

In the kitchen they have no range, no pots, no pans, no flour bins, no kitchen tables. But then they have no tables or chairs in the drawing room, and in the real native house the drawing room itself is only a lot of bed rooms with the paper shutters taken down. There is no reason why you should find anything in a Japanese house except mats and a charcoal stove for warming your fingers and making tea.

These and a cushion or two and a quilt to sleep on, with an elaborate conventional politeness, constitute the furniture of a Japanese house, except the guest chamber. And the articles in the guest chamber consist of a screen, a kakemono and a flower vase.

Along with his magnificent want of wants, so to speak, the Japanese combines a capacity to get huge pleasure out of what we would regard as trifles and after labors and sacrifices that we should think intolerable. This extraordinary patience and whole hearted enjoyment under all the niggardliness of his lot marks the Japanese as unique among the peoples of the world.

He lives on next to nothing and thrives on it. He always has a smile. He works whenever he can get any work to do. They are all week days to him. Instead of a seventh day, Sunday, he has his festa, a national holiday or a temple festival. In either case he goes a-faring to some temple and takes his

children or a friend. He is never too poor to have money to treat them.

He gives himself a holiday only when he is out of work, and his holidays are inexpensive. He just walks a hundred miles to see some famous garden in its glory. He carries his baggage in a box, wrapped in oil paper, and gets a bed at an inn for a sum equivalent to a cent of our money. His food is almost as cheap, and when the last turn in the road shows him the irises of Horikai or the house and cherry trees of Yoshino on the day of all the year he would not change places with the King of Great Britain and Ireland.

Judging by Western ideas, Japanese babies have a hard time, yet there are no healthier children in the world. The Japanese baby is dressed and undressed in a frigid temperature in winter, and in summer no care is taken to protect its tender little eyes from the full glare of the sun. In winter the small head is covered with a worsted cap of the brightest and gayest design and color. The black hair is cut in all sorts of fantastic ways, just like the hair of the Japanese dolls imported into this country.

The babies of the lower classes are generally carried on the back of the mother or little sister; sometimes the small brother is obliged to be the nurse maid. The kimono is made extra large at the back, with a pocket of sufficient size to hold the baby, whose round head reaches the back of the neck of the person who is carrying it.

It is not an uncommon sight to see children who are barely old enough to toddle burdened with a small brother or sister sleeping peacefully on their backs. At first one expects to see the child stagger and fall beneath the weight, but apparently none of its movements are impeded and it plays with the other children as unconcernedly as if it were not loaded down with another member of the family.

At Nagasaki among the women coalers who coal the ships one sees many who carry babies on their backs in this way. The mothers work all day in the rain or the sun or the snow, and the baby seems indifferent to everything.

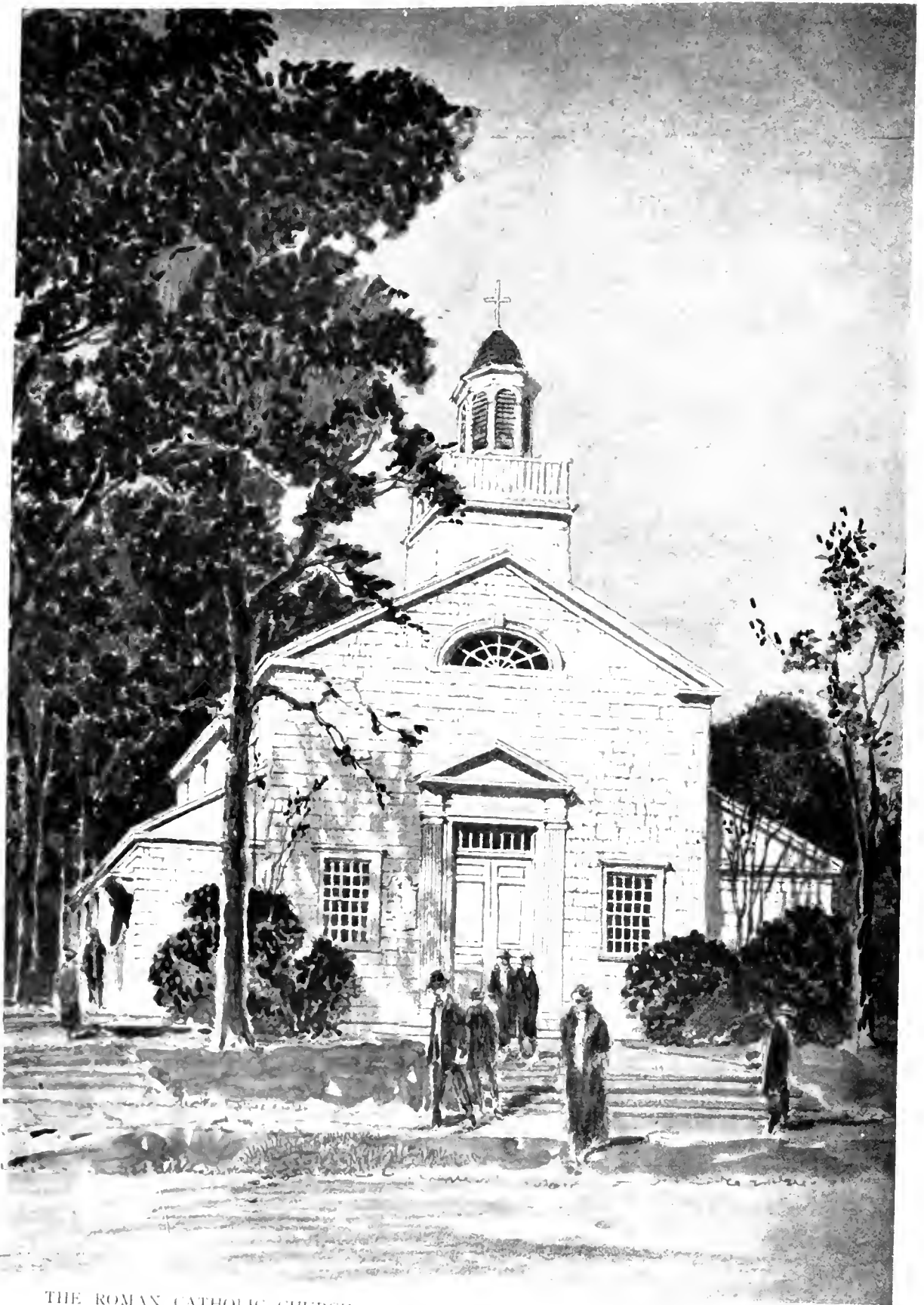

THE ROMAN CATHOLIC CHURCH OF ST. CLARE, GREAT KILLS, STATEN ISLAND
EGGERS & HIGGINS, ARCHITECTS

The Roman Catholic Church of St. Clare

Great Kills, Staten Island, New York

EGGERS & HIGGINS, Architects

IN a western city there is now being brought to conclusion, under the direction of a large church organization, a scheme for an educational group of buildings. The promoters of this undertaking contemplate the adoption of a Georgian Colonial type of architecture and further propose to include in the group replicas of many of the structures that are to-day landmarks of our Colonial history. The idea is based on the complete Americanization of every student and incidentally to serve to inculcate a viewpoint of patriotism.

Methods of Americanization in this country have been carefully studied and important work is being done. The Catholic Church in the United States has undoubtedly largely aided in seeking to inculcate a correct attitude on the part of its members towards their duties as citizens. The small church now being erected at Great Kills on Staten Island shows on the part of its clergy and congregation a fine sense of the fitness of things, of the duty of the Church in the promotion of every patriotic impulse, and in a much to be commented appreciation of its neighborhood.

We do not recall, and we doubt if ever before there has been built in this country a Roman Catholic church of any size that took for its architectural expression a style so purely American. And we are sure that now so excellent an example has been set that there will follow a further building of Roman Catholic Churches that will express in the finest way the high ideals of the Church in the United States, both religious and civil. These things are the well placed milestones on our path as a nation toward our highest ideals.

Great Kills, on Staten Island, formerly known as Giffords-by-the-Sea, was for many years a quaint old fishing village. The lives of the people were the lives of others in similar towns the length of our North Atlantic Coast. Its men were the sturdy element-braving type that fared forth at all seasons and at all hours. Its women, equally sturdy as a type, were of the quiet, reserved character that is bred in women who daily wait the uncertain return of their men folks from their fishing. The houses were the typical fishermen's cottages, with a sprinkling of the better type that showed the material prosperity of the village. The whole atmosphere of the town was purely American, the growth of American customs and the establishment of American ideals.

While no reasonable person will question those

matters of tradition that have for centuries caused the Roman Catholic Church to avail of a purely Roman type of architecture as an expression of its church edifices, yet, like all precedent it is but the acquirement of a habit based on a custom that no one has been disposed to question.

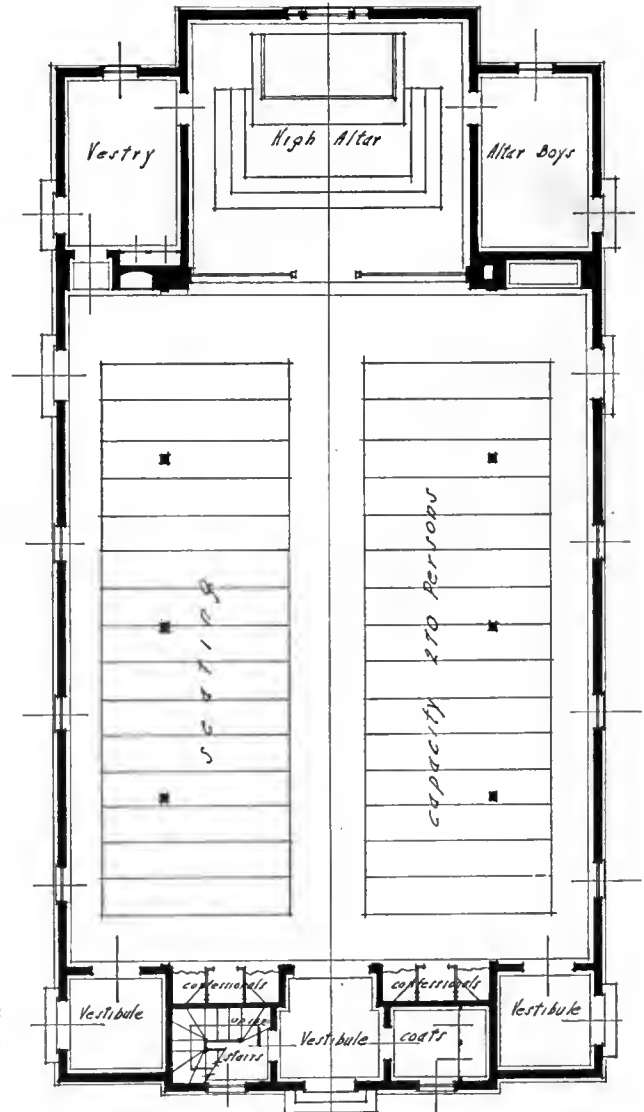

FLOOR PLAN

A church in this typically American town would naturally need to be of the town itself. It is therefore something worthy of mention when a commun-

(Continued on page 51)

Door of a Dutch Farm House, North Paterson, N. J.

(See reproduction of drawing by O. R. Eggers on opposite page)

I*N a preceding issue there was illustrated a gambrel-roof house, located on Staten Island in New York Harbor. While, as stated, this type of house was typical of the earlier form built by the Dutch when they settled along the Hudson River Valley, the later coming of the English and the intermingling of settlers from two countries so widely differing in their architectural traditions undoubtedly exerted certain influences, one on the other.*

While the doorway which Mr. Eggers has drawn for the present illustration is strongly influenced by the later Georgian motives as developed in this country, it appears to be an original part of an otherwise typically Dutch house. The door is divided after the Dutch fashion into two separately movable leaves and the stone door sill undoubtedly has its placement as part of the Dutch custom. But the general detail of the frame of the door is equally and unmistakably a relic of our early English Colonial architecture.

The paneling at the sides of this doorway is apparently hinged so as to close and form an outer door, a wise precaution in a section where the winters were often extremely rigorous. It becomes interesting in studying a detail of this character to note the effect of social conditions on the development of architectural details.

42^a



DOOR TO AN OLD DUTCH FARMHOUSE ON THE GOFFLE HILL ROAD, NORTH PATERSON, N. J.

THE AMERICAN ARCHITECT Series of Early American Architecture

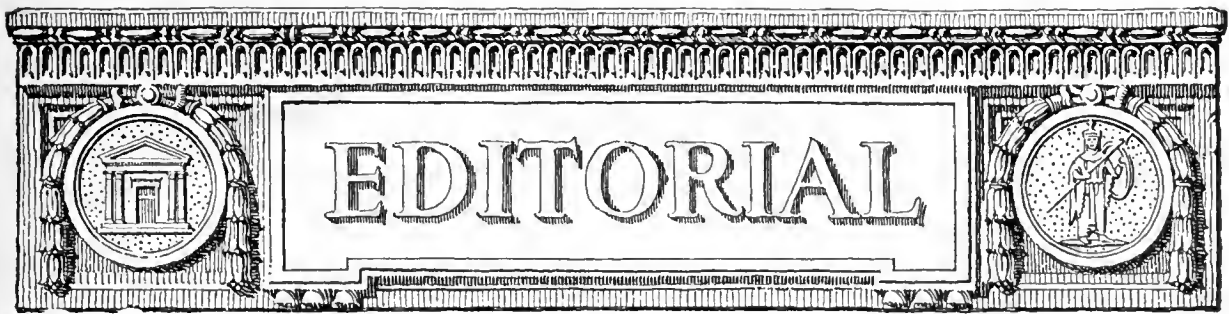

Confidence, Commonsense and Co-operation

EVERYONE, without exception, of the authorities who contributed articles to the preceding issue of *THE AMERICAN ARCHITECT* on the present and future of architecture and building, optimistically feels that conditions are daily becoming better.

Each one conservatively states the belief that owing to the enormous shortage that now prevails, there will be no sudden advance, the bulk being too large. But the feeling is generally expressed that within a few months building in this country will be generally resumed and will gather momentum to an extent that there will be a revival and activity greater than we have ever before experienced.

As to the profession of architecture, it is, as C. H. Blackall states, more nearly on a business basis than ever before, and has cast away a very considerable proportion of the purely professional attitude that has so long hampered it. This makes for a closer and more efficient relation with the engineer and builder, and will go a long way toward the restoration of architects to their erstwhile proper relation as master builders. These things mean better architecture, better satisfaction of clients and a more harmonious relation throughout.

Basically economic conditions in the United States are financially sound, states Francis H. Sisson, vice-president of the Guaranty Trust Co. of New York. Further, he offers the very sound advice that it is essential that to preserve our prosperity we practice just common sense, give the best constructive co-operation to Congress and the progressive business interests of the country. Co-operation in its highest sense is the keynote of future prosperity in the construction field. It has been lacking in the past, and its performance should be the duty of all in the future.

Not the least important element of this co-operation, so far as architects are concerned, will be the promotion of a better relation between their own profession and that of engineering. Each profession, as Kort Berle emphasizes in the interview published in the preceding issue, must recognize the

members of the other as fellow professional men and not as subordinates.

Louis J. Horowitz, president of the Thompson-Starrett Co., expressed the opinion that most of the drastic processes of post-war readjustment should be over in the early part of 1921, and that we may reasonably look for a gradual recrudescence of confidence from that time on, is something that may be accepted with confidence.

The keynote of our future course should be confidence, common-sense and co-operation. With these basic things always in mind, the future presents only the most hopeful prospect.

A Fund to Assist Young Architects

IN order to add encouragement to young architects in pursuing the long and arduous training necessary to prepare them for successful practice, an unknown donor has announced to the Board of Directors of The American Institute of Architects, through Mr. D. E. Waid, treasurer, that he will give to the Institute a sum amounting to \$25,000.

This amount is to create an education fund, the income from which is to be used at the will of the Institute for the benefit of the profession of architecture. The donor has suggested that the Board of Directors of the Institute appoint a committee to act in co-operation with the American School at Rome, to establish and administer one or more traveling scholarships, for which \$1,500 per year will become immediately available.

A condition of the gift is that when once the use of the income of the foundation is determined, such use can be changed in future only by a two-thirds vote of the delegates at two successive conventions of the Institute.

Every architect will learn of this new foundation with much satisfaction and will feel grateful to the man who has so liberally established it.

There are many men of large means in this country seeking to pose as patrons of the Fine Arts. The accumulation of large collections, bought with the utmost commercial sense of values, and often dispersed

at large profit, while accomplishing a certain end has not that permanent value that a fund affords.

Let us hope that so good an example as is shown in this gift of \$25,000 will result in additions to this fund which will afford the most practical encouragement to young men of demonstrated talent in the field of architecture.

Congress and the Housing Shortage

IN an address delivered by Senator William M. Calder of New York before the Marquette Club at the Hotel Commodore, he stated that Congress might find it necessary to appropriate millions of dollars to build houses and apartments to relieve the present shortage.

Senator Calder on his own part and that of the committee of the Senate of which he is chairman, has performed a valuable service in the investigation of the causes that have produced the stoppage in building operations. The facts this committee has developed will be of the utmost service to the building industry throughout the country. It is believed that the early resumption of construction may very well be left in the hands of those who are most directly interested. The appropriation by Congress of money to provide housing takes the whole matter into the field of politics and that is just exactly where it should not go.

If the government will continue in the future as it has in the past, and is now doing, to use its administrative and legislative authority in searching out causes, detecting dishonest combinations, and those activities that are in restraint of building progress, it will render a most valuable service.

The conduct of building now and in the future may safely rest in the hands of the architect and the builder, whose work in the past has been of the most practical and efficient character and on whom not even the slightest responsibility rests for present conditions.

The organization of the offices of architects and builders has always been based on the highest efficiency, and it is certain that that efficiency continues. If Congress will disperse the illegal combinations now known to exist, if the banks will make available mortgage money, if labor will recede from its profi-

teering, nothing can stem the wave of building construction that will sweep over the United States. Congress may very valuably act in stabilizing all the conditions that affect building and leave the result in the competent hands of the building industry.

How Much Will It Cost?

AFTER the prospective client has outlined his requirements to his architect, the first question he asks, nine times out of ten, is: "About how much will such a building cost?" Before the war, when prices were somewhat stable, it was not impossible to give a fairly accurate answer to this question, even before sketches or plans were made. Since the armistice, however, price changes have been so great and sudden that the problem of determining with a fair degree of accuracy the probable cost of a contemplated building before plans and specifications have been drawn has been a difficult one. The editors of THE AMERICAN ARCHITECT have had the subject under consideration for some months, and have even had typical plans and outline specifications drawn for various classes of buildings with the idea of having them priced in various sections of the country, and these prices revised from time to time to show changes and trend. However, after doing some work on this plan it was found to be impractical and abandoned for the simpler one of showing actual cubic foot costs of buildings of various types in different sections of the country. The first and rather meagre installment of these figures is given in the table on page 58.

It is hoped that future tables will be more comprehensive, and show better distribution. This will depend, however, upon the co-operation given by members of the profession. Without that it will be impossible to furnish the required data, but with it there should be no difficulty in making this service feature of very real value to practicing architects. Incidentally, it will enable them to overcome the impression that is all too general, to the effect that architects are unreliable in the matter of preliminary estimates.

To assist in making this feature of value, readers are requested to send in the information shown on the table printed on another page in connection with any buildings upon which they have taken figures within recent months.



HOUSE OF RALPH ISHAM, SANTA BARBARA, CAL.
CHILD'S & SMITH, ARCHITECTS

12

44 ✓



VIEW IN COURT
HOUSE OF RALPH ISHAM, SANTA BARBARA, CAL.
CHILDS & SMITH, ARCHITECTS



HOUSE OF RALPH ISHAM, SANTA BARBARA, CAL.
CHILDS & SMITH, ARCHITECTS



HOUSE OF RALPH ISHAM, SANTA BARBARA, CAL.
CHILDS & SMITH, ARCHITECTS

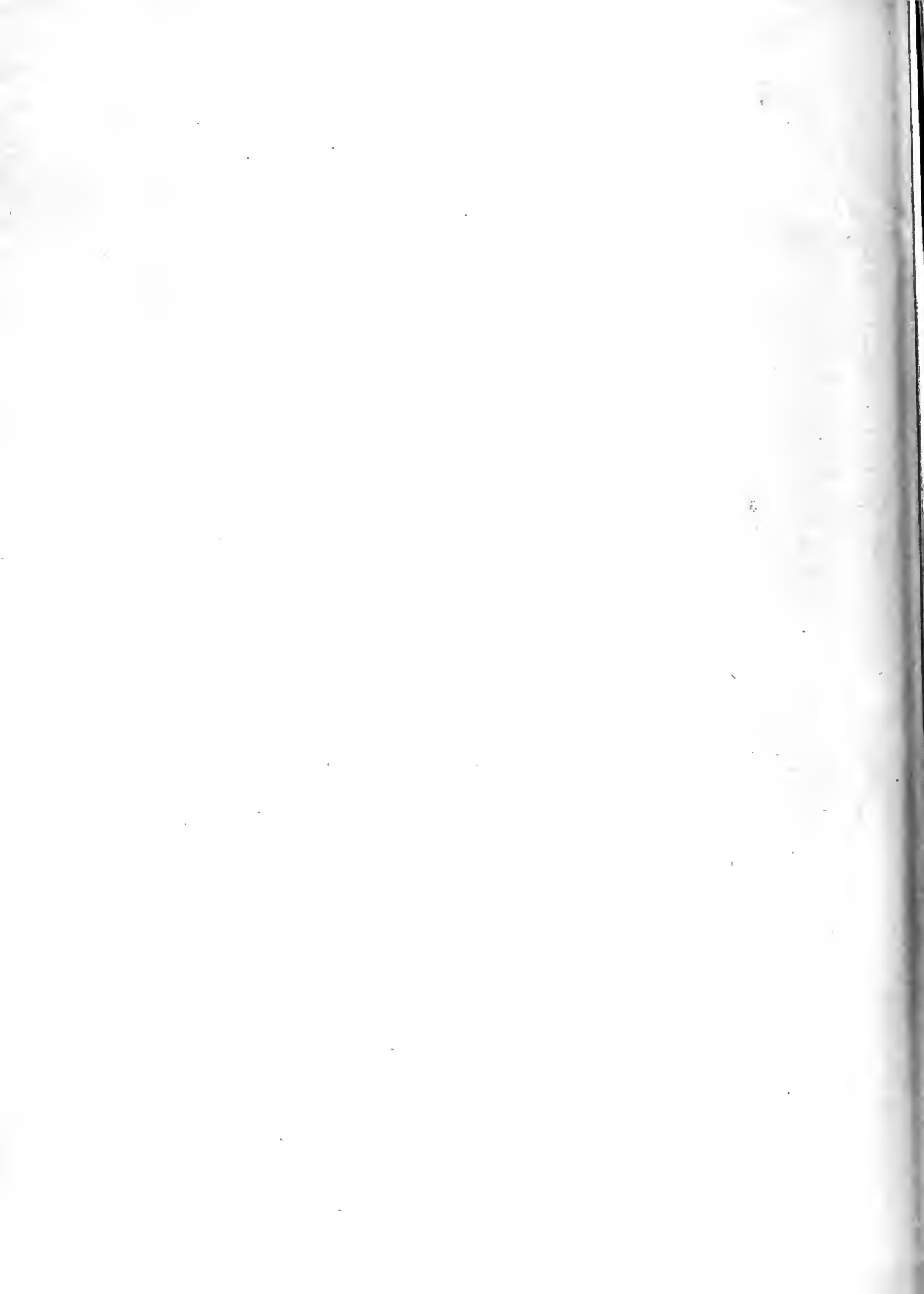



FIRST NATIONAL BANK, MENASHA, WIS.
CHILDS & SMITH, ARCHITECTS



FIRST NATIONAL BANK BUILDING, MENASHA, WIS.
 CHILDS & SMITH, ARCHITECTS



HOUSE OF A. C. GILBERT, NEENAH, WIS.
CHILDS & SMITH, ARCHITECTS



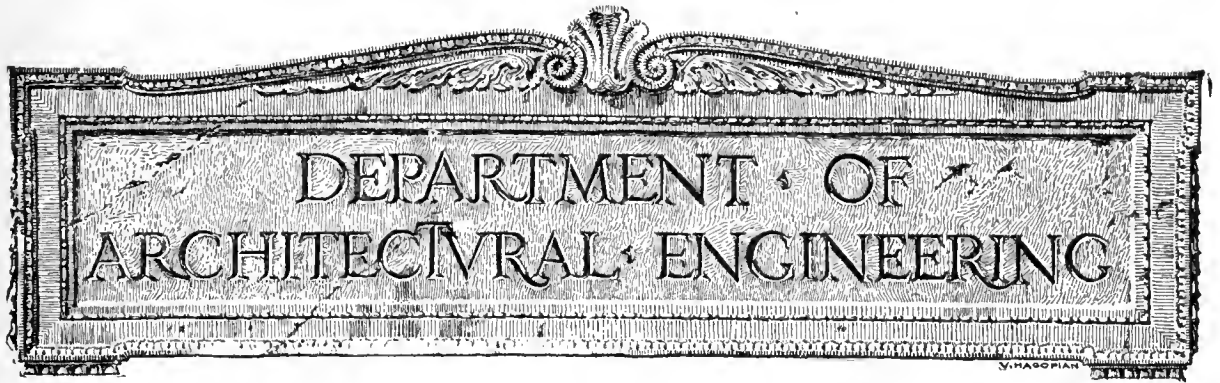

The Fate of High Bridge

Do the Facts in the Case Warrant Its Reconstruction or Demolition

SPANNING the Harlem River at approximately a continuation of West 174th Street, New York City, is High Bridge, a multiple arch masonry structure, over which a controversy is now in progress. The issue is, whether this bridge shall be altered or demolished. In considering the subject, it might be well to sketch briefly its history.

High Bridge was built as a part of the old Croton Aqueduct system constructed between 1837 and 1843, the new supply being first introduced on July 4, 1842.

hazardous for self-propelled vessels and very difficult for tows.

The aqueduct supported by this structure was in use until a short time prior to this country's declaring war with the Central Powers. Various reasons have been given as the cause for its present disuse. The statement that it is no longer of any value does not hold in view of a statement made by Merritt H. Smith, Chief Engineer of the Department of Water Supply, who, at a recent meeting of the



HIGH BRIDGE AS IT APPEARS TODAY

The outlines of Washington Bridge are visible just behind High Bridge

The original plans appear to call for 15 circular arches, 8 of which had a span of 80 feet and the remaining 7 of 50 feet, with a clear height of 100 feet above mean high water. As the current is very swift at certain elevations of the tides owing to the difference in the elevation of the waters of the Hudson and East Rivers, the threading of the arches is

American Society of Civil Engineers, at which the subject of High Bridge was under discussion, made the following statement:

“Let me tell you when it (the High Bridge Aqueduct) was shut down, and why it was shut down. On February 3, 1917—do any of you remember it?—we sent back the German Ambassador. We had four



ANOTHER VIEW OF HIGH BRIDGE SHOWING RAILROAD TRACKAGE PARALLELING WATERWAY.

aqueducts bringing water into New York City, three aqueducts and a pipe line. It was easier and safer to patrol two aqueducts than it was four; and if any devil had tried to destroy any part of any one of those aqueducts, the principal damage would have been done by the rush of water, not by the bomb; and for that reason, and that reason only, on February 3, 1917, the old aqueduct was closed down by my orders. The Kensico pipe line, which was also running at that time, brings Catskill water from the Kensico Reservoir. On the following day, the 4th of February, that was closed down, and for the same reason. That meant that we had two lines that could carry water to New York City and which would not be seriously damaged by bombs placed in the culverts, or at any other vulnerable points, because the damage would not be done by the rush of water, but would be done locally by the explosive."

According to Mr. Smith, in case the bridge was removed, it would be necessary at the very least to connect the old aqueduct on the Bronx and on the Manhattan sides of the river in order to crowd the water that comes through the old aqueduct through the new



HIGH BRIDGE AS IT WOULD APPEAR IF ALTERED IN ACCORDANCE WITH THE DESIGN OF THE DEPARTMENT OF PLANT AND STRUCTURES.

aqueduct tunnel. To do that, in carrying 225,000,000 gallons of water from the new aqueduct, and 60,000,000 from the old aqueduct, there would be a loss of between two and three feet of head at the 155th Street gatehouse, which it is stated would be a very serious loss, considering the difficulty now in delivering the old Croton service at sufficient elevation in a considerable part of the territory in which that water is used. If the bridge were removed, it was estimated by Mr. Smith that this new connection, on account of the alterations necessary, would cost about \$800,000.

THE suggestion for the removal of certain obstructing river piers of High Bridge dates back to 1911. The matter first came up in a letter to the City of New York from the Corps of Engineers, U. S. Army, in which attention was called to plans that had been received from time to time by the Secretary of War and by the United States Engineers' office for the First District, concerning the obstruction to navigation caused by the river piers of this bridge.

Some two years later, a number of property



A CLOSE UP SHOWING THE RIVER PIERS WHICH THE WAR DEPARTMENT CLAIMS FORM AN UNREASONABLE OBSTRUCTION TO NAVIGATION.

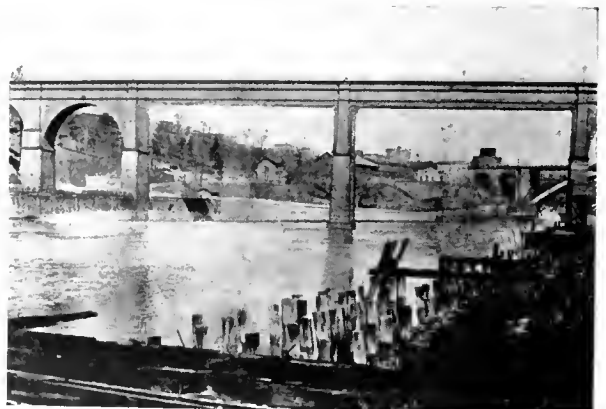

ACCORDING TO THIS SCHEME OF RECONSTRUCTION, WHICH LITERALLY CARRIES OUT THE ORDER OF THE WAR DEPARTMENT, STEEL GIRDERS WOULD SPAN THE WIDENED OPENINGS. ECONOMICAL, BUT UGLY.



ANOTHER SUGGESTED METHOD OF RECONSTRUCTING HIGH BRIDGE

owners and business men along the Harlem River in the Borough of the Bronx, made complaint of the obstruction along the Harlem River, and it seemed necessary then to present a report to the city authorities. Such a report was presented in 1915. While the bridge crosses a navigable stream, this report pointed out that it is an aqueduct rather than a bridge. It incidentally carries a footway. It is not a highway bridge in the ordinary sense of the word. It is one of the most notable structures in or about the City of New York, and its removal or the serious mutilation of its appearance would be a public misfortune, and should only be considered in case it was shown that it forms a serious obstruction to navigation, which could not be removed or mitigated except by taking out one or more of the piers. The removal of the bridge was not considered at that time.

Apparently the War Department did not press the matter for some time and it was not until the early part of 1920 that the matter was brought to a head by the following notice being served on the New York City authorities:

The Secretary of War having good reason to believe that the bridge over the Harlem River, New York City, known as "High Bridge," is an unreasonable obstruction to the free navigation of said river, on account of insufficient clearance between piers, it is proposed to require the following changes to be made in the bridge within one year from the date of service of order by the War Department, to wit: Two alternate piers to be removed, and a vertical clearance of at least 100 feet above mean low water to be provided in each of the proposed widened spans.

This required action. Although but a short period remains before the expiration of the time stated in the order, no work of reconstruction has been started. Public hearings have been held and various suggestions have been made.

THE suggestion which advocated the entire removal of the bridge has brought forth a storm of protest. This suggestion was made by the Commissioner of Plant and Structures in a communication to the Board of Estimate and Apportionment.

Since this communication states the case for the removal of High Bridge, the retention of which, with suitable alterations, the American Institute of Consulting Engineers, the New York Chapter of the American Institute of Architects, the American Society of Civil Engineers and the American Institute of Fine Arts have gone on record as favoring, it is here published in full.

To the Honorable

The Board of Estimate and Apportionment
of the City of New York:

"In the matter of improving the navigation facilities on the Harlem River, in the vicinity of High Bridge, the various plans for treatment of High Bridge submitted to the Board of Estimate and Apportionment have been given full consideration, and it appears to me that the proper action to be taken by the Board of Estimate and Apportionment is the removal of this bridge.

"This Department assumed this position at the hearing of the New York Harbor Line Board on March 30, 1920, when it was proposed by that Board to remove two alternate piers. Following the suggestion of the Harbor Line Board, plans were prepared by this Department providing for the removal of two alternate piers and the construction of two spans of steel and concrete. An arch effect was to



A MODIFICATION OF THE DESIGN OF THE DEPARTMENT OF PLANT AND STRUCTURES WHEREBY THE HORIZONTAL LINES OF THE STEEL GIRDERS ARE "CAMOUFLAGED" TO GIVE THE IMPRESSION OF A MASONRY ARCH.

THE AMERICAN ARCHITECT

be obtained by the use of these materials. The aqueduct line on the bridge was to be maintained, and the cost of the work was estimated at \$630,000.

"On June 11, 1920, the Board of Estimate and Apportionment referred two communications in reference to High Bridge reconstruction to this Department for report, as follows:

Communication dated June 2, 1920, from Mr. Wm. J. Wilgus, submitting on behalf of a Committee of the American Institute of Consulting Engineers and the New York Chapter of the American Institute of Architects, arguments in favor of retaining High Bridge, and that necessary alterations be so made as not to mar the beauty of the structure.

loading on this pier, have elements of uncertainty that might entail failure.

"In the removal of two alternate piers no piles are to be driven and the loads on the various piers are decreased.

"There are no record drawings extant showing how this pile foundation for Pier 12 was constructed, and in my judgment in the reconstruction of this pier we would have to rely a great deal on what we would find after making excavation in a cofferdam.

"The camouflaging referred to by Mr. Wilgus in connection with the removal of alternate piers should receive little consideration as the term can be applied to many of the city's important structures where steel and masonry are used in conjunction; as for ex-



DESIGN SUGGESTED BY THE NEW YORK CHAPTER, A. I. A., AND THE AMERICAN INSTITUTE OF CONSULTING ENGINEERS

This shows the best treatment of any of the schemes so far suggested.

Communication dated June 3, 1920, from Charles Paff & Co., Architects and Engineers, submitting for consideration designs for the improvement of the water spans at High Bridge.

"The plans submitted in these communications provide for the removal of two adjacent piers and the building of one masonry arch. No estimate was submitted by Charles Paff & Co. The estimate submitted by Mr. Wilgus called for the expenditure of \$830,000.

"The Engineers of this Department have examined in detail the estimates as furnished by Mr. Wilgus and find that the cost would be about 50 per cent. in excess of his estimate of \$830,000 or \$1,250,000.

"The driving of additional piles at Pier 12 and the attaching of new masonry to the present pier masonry, which will mean additional and eccentric

ample, the Municipal Building is a steel structure covered with granite and not a granite building.

"Your board has before it three propositions:

1. Removal of High Bridge—cost \$500,000.
 2. Removal of two alternate piers—\$630,000.
 3. Removal of two contiguous piers—\$830,000.
- (Wilgus), which the Department's Engineers believe will cost at least 50 per cent. more or \$1,250,000.

"High Bridge, if reconstructed, will provide channels with vertical clearance of 101 feet at mean high water.

"Washington Bridge to the north of this structure has a clearance of 135 feet at mean high water.

"All the East River bridges have similar clearances, while the Hell Gate Bridge has a clearance of 140 feet at mean high water.

"Thus the clearance at High Bridge, if recon-



ACCORDING TO THE PLAN SUGGESTED BY THE ABOVE DRAWING FOUR PIERS WOULD BE REMOVED AND THE RIVER SPANNED BY A SINGLE MASONRY ARCH

structed, *will always be the limiting height for vessels* navigating around Manhattan Island.

"No one can say that the Harlem River with the improvements contemplated will not be used by ocean going vessels. Note the class of vessels now operating in Newtown Creek which is only 250 feet wide—Harlem River 400 to 440 feet channel.

"The question of continuing High Bridge as an aqueduct is one that might have some weight if the city did not have the Catskill supply in addition to the new Croton Aqueduct supply which is carried to Manhattan by a tunnel under the Harlem River.

"The High Bridge conduit which connects the old Croton aqueduct with Manhattan has not been used in many years, and I would suggest that if this old aqueduct is to be used in the future, it should be for the purpose of increasing the water supply in the Borough of the Bronx, which to-day has a larger population than the old City of New York had when the old Croton aqueduct was opened.

"The old City of New York in 1850 had a population of 515,547 and the population of the Borough of the Bronx in 1920—730,016.

"If it be decided to remove the bridge entirely the stone can be stored along the Harlem River Speedway until required for use in the building of the bulkhead wall along the Harlem River at and near the location of High Bridge. The Bulkhead walls of the Speedway will require reconstruction in the near future.

"The contemplated improvement of the Harlem River is a matter that affects the whole City of New York. This improvement would mean the bulkheading and the dredging of the River to provide facility not only for the present traffic but for the future that will ensue after these improvements will have been made.

"It will mean much in the cost of handling food products, supplies and materials.

"The proposed work of straightening the Harlem Ship Canal at Spuyten Duyvil and the dredging at the Harlem Kills connecting the River direct with

Long Island Sound, as a matter of business policy, should mean the removal of this Bridge. The Engineers of this Department have fully considered this entire question and I believe that the only proper action to be taken by your Honorable Board is the entire removal of this bridge."

Yours very truly,
(Signed) GROVER R. WHALEN,
Commissioner.

THE future of the Harlem River is a matter of pure speculation. It is entirely within the realms of possibility that ocean going vessels may some day ply its waters. Still one can hardly view the present High Bridge and contemplate its removal without a tinge of regret. Surely this is an age of Commercialism if such things must be. A far more satisfactory solution, to the minds of all lovers of art, would be the reconstruction of the bridge according to the design already referred to. This, however, does not comply with the order of the War Department in that it would cause the removal of two adjacent and not two alternate piers. To obtain such approval, the design would have to be submitted to the War Department by the City of New York. The entire subject will be discussed by the Board of Estimate and Apportionment at its meeting on January 21, 1921.

From the standpoint of historic interest, sentiment and the preservation of structures of artistic merit as well as for utilitarian reasons, the bridge should be retained, with only such alterations as will remove its objectional features without marring its beauty. As a further argument in favor of its retention with suitable alterations, it is pointed out that it is the only bridge across the Harlem River between Washington Bridge (181st St.) on the north and Central Bridge (155th St.) at the south. In reconstructing the bridge it could be altered to function as a highway bridge by being provided with an effective roadway approximately 20 ft. wide with a sidewalk on either side supported by brackets, and an effective connection made with the street system on the Manhattan side.

A New Idea in Lighting Fixtures

The Portable Feature Has Many Advantages

THE general public, as well as the electrical contractor, has been interested in a new design of electric outlet for use in homes, offices, public buildings and everywhere that electric wiring and electric lighting are used. The purpose of these outlets is to give every house or building a system of wiring that will be flexible enough to meet all conditions without the necessity of alterations or additions to the circuits already installed.

The design and construction of the new outlet are shown clearly in the accompanying illustrations. They are intended to be located in different places in the walls and ceilings so that wall lights and ceiling lights may be attached to them directly without the use of an extension cord. In fact, any electrical appliance may be readily attached to these outlets. Each room has more outlets than are necessary at any one time. When not in use they are covered by paintings or they are painted in keeping with the wall decorations, so that they are invisible. The plugs for the ceiling outlets are designed strong enough to carry the heaviest chandeliers made.

The provision for many more outlets in each room than are necessary at one time permits the lighting to be arranged to suit the individual taste of the occupant. It permits a ceiling light here, a desk light there and a wall light in the alcove. When the furniture is rearranged, the lights may be located to suit.

It is often desirable that the lighting fixtures in a room be in keeping with the style of furniture. When moving into another house this is not easily possible if the lighting is fixed, but it is easily accomplished with the new outlets and changeable lighting fixtures.

The lighting then becomes a part of the room. The style of fixture is selected to harmonize with the furniture.

In offices these outlets are also valuable. When it is necessary to move to new space or for any reason to alter the partitions in the present space, these outlets lend themselves readily to the new arrangement.

CEILING PLUG

The ceiling plug is designed to support the heaviest chandelier, and its rigidity increases in proportion to the weight that it supports.



Partitions may be run without thought of the wiring on the floor, because there will always be an outlet where it is needed.

The expense and inconvenience of making alterations in electrical wiring has often prevented changes in the lighting of buildings, rearrangement of furniture and rearrangement of office partitions, even though such changes would be desirable and economical. The new outlet system of lighting eliminates the expense, the dirt and the inconvenience.

The Electric Outlet Company, New York City, is making these new outlets. This company foresees the day of standardization of electrical fixtures.

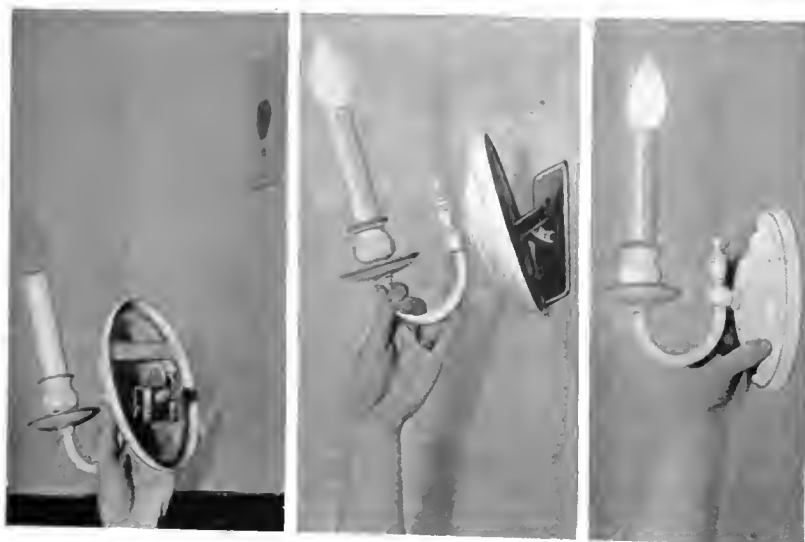

MOUNTING THE FIXTURE

The method of placing a portable fixture in a wall outlet is shown here. The operation is simple and is accomplished in the same way that a plug is inserted in a socket. Such outlets as these are located in convenient places in the room. The lighting scheme then becomes entirely flexible and may be readily suited to the style or arrangement of the furniture.

THE AMERICAN ARCHITECT

(Continued from page 41)

ity now largely composed of many different elements as to taste in art, in social ways and daily habits of living, so unanimously agree on establishing a precedent that one wonders has not heretofore been attempted.

The structure wanted had to be at least 40 by 80 feet to provide for its known requirements and to give room for normal expansion. A small fund of approximately \$25,000 was available, and the problem has been to provide an attractive, well constructed edifice that would meet requirements and which could be built within the money at hand. This the architects have accomplished in the most successful manner.

The feature of the plan is placing on either side of the main structure of extensions approximating twelve feet in width. This provides the additional space for the necessary seating and does not detract from the symmetry of the plan, which follows the best precedent of the Georgian.

Further, this arrangement of side extensions insures better interior lighting and also better circulation of air and natural ventilation. By introducing the side wings and confining the present main structure to a comparatively narrow plan (it is but 20 feet in width) the costly construction of a 40-foot span has been avoided, and a much more practical and better architectural result obtained.

The choir loft has been placed at the front of the church over the entrance. The organ will be of an early type, low in cost, but adding to the feeling that the architects have so successfully attained, of an early American church interior.

The low tower on this church with its balustrade and cupola further carries out the feeling of a fishing village church. It was in these cupola that was hung the bell that served many purposes besides that for which it was consecrated. Its notes announced the arrival of some long overdue fishing fleet, it called to council on occasions of public interest, and often when the church was used as a schoolhouse, hastened the lagging steps of school children.

Around this cupola is a narrow platform, which in earlier New England churches and in many pretentious houses, was built as a "Captain's walk." It was on these balconies that retired sea captains took exercise and scanned the horizon for a glimpse of some expected sail.

St. Clare's at Great Kills is an innovation in the architecture of Roman Catholic Churches that every

patriotic man will commend. We believe it is the forerunner of many such, or, at least we hope so.

Criticism and Comment

The Editors, THE AMERICAN ARCHITECT:

Your editorial in the Dec. 15 number has greatly interested me, as I believe the subject is one of vital importance in the development or even maintenance of architecture as a profession.

Architects are much inclined to consider architecture purely as a Fine Art, as something apart from the scientific features, or from the engineering involved in various forms. In this I believe the profession is making a serious error. The public taking the cue from the architect is naturally inclined to turn to the engineer or even to the contractor for advice which should come from the architect. Continued to its natural conclusion this leaves the architect in a position of being merely a planner who applies to his plan the purely artistic principles of form and detail on paper, and without assuming any responsibility whatever, and with little claim to knowledge of the scientific or engineering features involved in detail, undertakes to supervise the execution of the building, only so far as its artistic features are involved. Is this what the profession of architecture is leading to? Some, including many engineers, seem to think that this point has already been reached.

As stated in your excellent editorial, "engineering is (or should be) an essential element of architecture." The various forms of engineering, scientific in their nature, should be considered as highly specialized branches of architecture, not as something apart from it.

Architecture should be considered as the combined Art and Science of Building, and the practice of architecture conducted accordingly, co-operatively with engineering. The architect then might become the true Master Builder. The tendency of the schools, however, is to set up two distinct professions, one of which is Architecture or the Fine Art of Building, the other being Engineering, which so far as it applies to building refers to the Science of Building. The public it is hoped will continue to admire the Art, but it will undoubtedly pin its faith to the Science every time, and therein lies the danger.

VICTOR ANDRE MATTESON, Architect.

Chicago, Ill.

Current News

Happenings and Comments in the Field of Architecture and the Allied Arts

From the Library of Congress

The Library of Congress of desirous of securing copies of *THE AMERICAN ARCHITECT* of November 3, 1920, to complete its files, and would appreciate the courtesy of the gift of this copy to the library. Our supply of this issue has been exhausted. We therefore suggest that if any of our subscribers can spare a copy of November 3 they communicate with Yale O. Millington, Periodical Division, Library of Congress, Washington, stating their willingness to extend this courtesy.

Johns Hopkins Plans \$11,500,000 Buildings

Plans involving an expenditure of \$11,500,000 have been formulated by the Johns Hopkins Hospital, Baltimore. They include rebuilding all the principal buildings of the hospital group and providing improvements required because of the growing demand on the institution.

The principal new structure is to be a dispensary 420 by 100 feet and seven stories high. There will be a pathological building costing \$600,000. Other portions of the plans follow. Two million dollars for general improvements, \$400,000 for women's clinic, \$1,714,000 for out-patient or dispensary building, \$1,000,000 for dispensary, \$100,000 to \$500,000 for extension of heating and power plant, \$500,000 for additions to nurses' home and \$250,000 for school of nursing.

Y.M.C.A. Real Estate Lecture Course

In view of the general interest in real estate buying, selling, renting, legislation and building, the Educational Department of the West Side Branch Young Men's Christian Association and the Board of Education of New York City have planned a most timely co-operative series of real estate lectures of mound educational value.

The lectures given under the auspices of the Board of Education are *for the buying and general public*, are offered free, and are given at certain public high school auditoriums and at other places in Manhattan, the Bronx, and in Brooklyn and Queens boroughs. A schedule of the Board of Education real estate lectures covering the topic thoroughly has been announced and further information may be obtained

from the Bureau of Public Lectures, Board of Education, 157 East 67th street, New York City.

Course more particularly for the professional public will start on January 11 at the West Side Young Men's Christian Association. The speakers are representative men of wide repute in their field. The series includes fifteen lectures.

Great Roosevelt Memorial Proposed

Decision that the Theodore Roosevelt memorial to be constructed in Washington would be "in no way a utilitarian structure," but a monument "comparing in grandeur and impressiveness" with the memorials to Washington and Lincoln, was reached at a meeting here yesterday of the committee of the Theodore Roosevelt Memorial Association, headed by Elihu Root.

The committee announced that it had considered several sites for the memorial, which will require a tract of land of about sixty acres, but would reach no decision on a site until it had made a further study of possible locations. It is hoped, the announcement said, that a design for the memorial which would "meet the approval of the whole American people" can be completed within three months."

Architectural Exhibit for Ghent, Belgium

The Provinces of East and West Flanders, comprising the Ghent consular district, were among the greatest sufferers from war devastation. All industries were more or less ruined, and the year 1919 was spent in reconstructing buildings, putting in new machinery, obtaining raw materials, etc., in order to renew factory operation. At the present time, most of the linen and jute mills have been rebuilt and some of the cotton mills.

To collect useful and artistic information which will aid in rebuilding this devastated area, an Exposition of Architecture, Building and Similar Industries will be held at Ghent in April and June, 1921, at the Palais des Fêtes, under the auspices of the National Government, the Province, and the city.

Full information may be obtained from the "Exposition Internationale d'Architecture, du Batiement et des Industries Connexes" 15 Coupure, Ghent, Belgium.

Chicago News Notes

Decrease in building activity during 1920 has cut the tax assessment value of Chicago and Cook county real estate by at least \$1,000,000. This is the estimate of Stephen Griffin, chief clerk of the Board of Tax Review.

Superintendent Mortenson of the Chicago Public Schools has asked the Board of Education for appropriations aggregating \$30,000,000 to be spent for thirty new public school buildings in Chicago. The request is being considered in committee.

The Illinois Society of Architects has recently admitted several new members. Among them are J. Bernard Barthel, Allen L. Barnes, Murray D. Hetherington, Richard Griesser, Carl Harber, Arthur Jacobs, Edward A. Klamt, William H. Lantz, Charles O. Liska, James R. Morrison, Francis W. Puckey, Issac S. Stern, William Stuhr, Carl M. Teutsch, Theodore C. Visscher, Dwight G. Wallace, Maurice Roy Wallace, Leo H. Wiesfeld.

Wealthy residents of Evanston, Chicago's largest northshore suburb, are objecting strenuously to the zoning plan of that town, which will permit the introduction of business houses, such as stores, in certain exclusive residential sections.

The upper Michigan avenue property owners are planning to try the New York gold medal plan for keeping up appearances in the new district. A gold medal will be awarded to the property owner in the north central district—as the district is officially termed—during the year.

Greater New York Miscellanies

Travelers to Manhattan

According to statistics compiled by the general passenger agent of the Long Island Railroad, 295,814,532 persons were handled by the railroads, ferries and tubes which connect Manhattan with the trunk line railroads with terminals in New Jersey during the current calendar year. He estimated the in-and-out movement of people during 1919 at 250,000,000.

The Size of Queens

Queens is about the same size as Manhattan and Brooklyn together, but has only about one-ninth of their total population, according to the last census.

Long Island Land

There are 1,000,000 acres of land on Long Island, populated by 2,721,000 people. The Borough of Brooklyn has 49,680 acres. The total extent of the land on the island that can be devoted to industrial, residential and gardening purposes is 881,000 acres, all of which is within easy access of New York City.

First Stage to Boston

In 1700 New York was first connected with Boston by a regular stage, which took forty-one hours to make the distance. An air line now covers the distance in about three.

Will Consider Housing Problems

Most of the sessions of the Chamber of Commerce of the United States at Washington, January 27 and 28, will be devoted to housing problems. The three main topics will be: The social and civic effects of housing shortage; effects of building stagnation on business conditions, and the housing of employes by industrial concerns. John Ihlder, formerly field secretary of the National Housing Association, is head of the newly created Civic Development Department of the Chamber of Commerce of the United States, the headquarters of which are at Washington.

Gotham National Bank—A Large Transaction

Eight floors in the new Gotham National Bank Building, now nearing completion, at Broadway and Fifty-ninth street, New York, have been leased by a graphophone company for a term of years at an aggregate rental of over \$1,000,000. This, it is believed, is one of the largest transactions of its kind closed north of Thirty-fourth street, and involving a record rental for the Columbus Circle zone.

The lease serves to accentuate the uptown trend of business and the desirability of a business location accessible from all points of the Greater City. Many downtown firms have recognized the importance of Columbus Circle as a new centre of business. To date leases have been signed with a number of firms whose former location was below Canal street. If the demand for space continues at its present rapid rate, this building, which is the highest of all business structures north of Forty-second street, will be entirely rented at the time of its completion, February 1, 1921.

Weekly Review of the Construction Field

With Reports of Special Correspondents in Regional Centers

IT is extremely gratifying to know that this journal's optimistic attitude regarding business conditions during 1921 is shared by a very important group of bankers and industrial leaders of the country.

Judge Elbert H. Gary, chairman of the board, United States Steel Corporation, looks forward to a promising year.

"If I read aright the signs of the times," he says, "we may look forward with confidence to marked improvement in business results, perhaps not so soon or so rapid as we could wish, but as certain and as satisfactory as the disposition and the action of the majority of the people themselves will permit.

"With its great and increasing wealth, its natural resources, its productive capacity, its location, and with a well-defined and settled policy to foster and encourage its industries, who can measure the future natural growth and strength of the United States? We have the opportunity to remain the leading nation of the world, financially, commercially and industrially."

Daniel Guggenheim, of Guggenheim Brothers, believes that optimism will replace pessimism in this country.

"There will soon be the beginning of a new era of prosperity for the people of the United States," he points out. "Such depressions as we are now going through rarely last long in this country. The tremendous deflation now taking place is going to bring into our country great prosperity. There is no need for a long-continued business depression in the United States if the leaders of industrial enterprises will rid themselves of unfounded fear of the future."

This opinion is shared by Bernard M. Baruch, formerly chairman of the War Industries Board. Mr. Baruch emphasizes the fact that "we have a vast opportunity in making up for the work that has been long left undone, as well as in the performance of the current profitable tasks that await us. These tremendous works will require labor, capital, brains and materials in ever-increasing volume. We have scarcely scratched the resources of our own country as yet, and there are limitless fields in foreign lands for our enterprise and our capital. The world is ours in a wealth-making sense."

To preserve this prosperity of which Mr. Baruch speaks, there is chiefly needed "just common sense and constructive co-operation between Congress and the progressive business interests of the country," according to Francis H. Sisson, vice-president of the

Guaranty Trust Company of New York. "Basically," he emphasizes, "economic conditions in the United States are absolutely sound."

Their soundness is vouched for in the fact that the year just passed was the "record year of American railroad operation," according to the review of the railroad situation for 1920 by Thomas de Witt Cuyler, chairman, Association of Railway Executives.

As to the future, Mr. Cuyler has this to say:

"In my judgment the American railroad companies during the present year have fully justified, and during the coming year will make every effort to *continue* to justify, the support and confidence which public opinion . . . has already accorded them."

Samuel P. Colt, chairman, U. S. Rubber Company, who comes constantly in contact with the many conditions affecting the export trade, has this to say about it:

"I am optimistic as to the future of our foreign trade and the ultimate restoration of new levels in exchange, which, while far from normal, will be reasonably steady and permit the interchange of goods with foreign countries."

Current wholesale prices for the New York market, for the week ending January 9, follow:

LUMBER: *Yellow Pine*—B & Btr F G Flooring, 2½" face, \$59.50; Long Leaf Dimension, SISIE, No. 1 Com., 2x4", \$37; Merchantable Long Leaf Timbers, 12x12, 10 to 20 ft., \$61.

North Carolina Pine—Roofers, 12/16x6" (Air Dried), \$28.50; No. 2 and Better Flooring, 2½" Face, \$61.50; Tonawanda White Pine, Fine Common, 4/4x8 and up, \$106.

Douglas Fir—No. 1 Clear Flooring, 1x4 (VG), \$71.50; Dimension, SISIE, 2x42, 16', \$42.25.

W. Va. Spruce—2x4", 16', \$54.50; Adirondack Spruce, 2x4", 16', \$42.25.

Penn Hemlock—Base Price, \$50.

Cypress, Factory Selects, 4/4, \$105; Spruce Lath, \$8.

Current retail prices (except brick) are as follows:

BASIC: *Brick*—Hudson Common, \$16-18; Fire Brick, Standard No. 1, per M, \$85; "Haverstraw" Hollow, \$25.

Cement—Domestic Portl. bbl., N. Y. yd., \$4.80

Gravel—Delivered to job site, \$4.25 per cu. yd.

Grit—Delivered to job site, Cow Bay, \$3.50 per cu. yd.

Iron and Steel—Wire Rods, No. 5, Common Basic

THE AMERICAN ARCHITECT

or Bessemer Rods to domestic consumer, \$57; Chain Rods, \$57.

Structural Steel—From N. Y. stocks, small lot quantities, cents per lb. *Bars*—Refined iron, base price, 4.70c. per lb.; Swedish bars, base price, 20c. per lb.; Soft steel bars, base price, 3.48c. to 3.70c.

Beams and Channels, Angles and Tees—3"x¼" and larger, base 3.58c. to 3.80c. per lb.; under 3"x¼", base 3.48c. to 3.70c.

Lime—Delivered job site, standard 300-lb. bbl., per bbl., \$5.20. Common Lime, standard 300-lb. bbl., per bbl., \$5.20. Hydrate Fin. Lime, per ton (cloth, paper bags), \$31 and \$29. Common Hydrate Lime, per ton (cloth, paper bags), \$25 and \$23.

Sand—Per cu. yd., delivered job site, \$2.75.

Stone—Broken, cu. yd., delivered job site, \$4.00.

Stone, Building—Indiana Limestone, \$1.81 to \$1.85; Ohio Sandstone, \$1.75 to \$2.35; Kentucky Limestone, \$2.07 to \$2.07; Marble (Tenn.), \$5 to \$5; Granite, \$2 to \$3.50.

(Special Correspondence to THE AMERICAN ARCHITECT)

SEATTLE, January 10.—With the stock taking period over and adjustments made for income taxes, Pacific coast business men are asking each other the question daily, "When?" and how the construction revival so long deferred is to be brought about. Architects in many instances have their hands full of new projects while awaiting the word from investors as to the time they believe the prices have hit bottom, in order that this section can go on a normal basis. It is apparent that in the steel industry lies the answer.

That reconstruction must be begun after prices have fallen lower is generally believed by jobbers in the most advantageous position to judge. Liquidation of stocks in the hands of manufacturers, jobbers and retailers is one plan. Another is to attain a price level that will hold long enough to restore confidence in the new prices.

In the event that manufacturers, jobbers and retailers did this thing and converted stocks into cash and strong accounts, there would follow a resumption of buying on the part of all, and the banks would have sufficient cash to loan at low interest rates. A proper level of prices, however, must be struck before there can be any change. Buyers must know that tomorrow's list will not show that they have lost.

Large operators, regarding these questions as vital, are studying on plans for solution. That there is a surplus of all merchandise and a shortage of credit and that to get rid of both, stocks must be converted into cash and loans liquidated is the feeling. When this is accomplished business will expand in volume and interest rates made low, these

operators assert, and an immediate start now when production is low would bring about the change with the least injury to all.

In the liquidation process prices must naturally seek a lower level, because lower prices are necessary to stimulate consumption and buying. Large operators have it in mind that the level has been reached when there is evidence of renewed buying. What this level will be is only conjectural, proven by the lack of uniform opinion as to the future values and low points on commodities. Jobbers and manufacturers who believe that future values will look right and clear are increasing in number. Stability of prices will precede an upward tendency.

Jobbers in steel intimate that the necessity of replacement value cost must be the basis of readjustment of prices. This readjustment, to be far sweeping and conclusive, jobbers point out, must begin at the mills and continue on down the course until it reaches the consumer. Many interested jobbers and manufacturers are strong in the conviction that this level will be considerable above pre-war prices if legitimate profits are to be maintained.

Large operators who have outlined the course of economic events as stated declare that after the period of readjustment no stronger exponents of optimism and faith in the country's business welfare can be found than among those who are endeavoring to direct and aright the route of American commerce now rocking on a practically uncharted sea.

There is an ample supply of nails, pipe and sheets for all immediate demands. Jobbers are not operating with any idea of accumulating stocks on a future demand, but are preparing to take care of what may arise with the early spring prospects. Prices are stationary.

The fir lumber market is steady. Production by 119 associated mills, which represent the bulk of the cut in the West coast lumber territory, was 54 per cent. of normal, due to the year-end closing down, interruption of which is indefinite. Wages in the mills and camps have been cut 25 per cent., and the men have uttered little protest. The mills hold unfilled orders for 2,485 carloads.

Pacific coast architects, particularly those in this territory, state that they have many big jobs in prospect, with orders to refrain from proceeding farther until investors are satisfied that prices have settled to a substantial bottom.

(Special Correspondence to THE AMERICAN ARCHITECT)

CHICAGO, January 10.—The new year opens here with every indication pointing to an early resumption of building activity. Only favorable weather now seems necessary to bring the industry to life after several moribund months.

Lumber and materials are gradually settling in

THE AMERICAN ARCHITECT

price, so that the cost of construction is considerably lower than during the spring and summer of last year and labor is showing a much more docile attitude, both as to its willingness of endeavor and its standpoint on wages. A very significant recent movement was the voluntary offer of some 9,000 employes of the Pullman Company, many of them in the woodworking trades, to accept a wage reduction of 20 per cent. This offer was made without suggestion or coercion from the Pullman Company, the step being taken by the shops committee as a concession to the spirit of readjustment of industry.

The movement has, of course, no direct bearing on the building trade except that it emphasizes the growing improvement in the labor situation, which in the past has been one of the most stupendous stumbling blocks in the path of construction in the Chicago district.

For the holiday period a somewhat general dullness prevailed in the building industry, as was to be expected, but the improved mercantile situation brought about by Christmas and pre-inventory buying left the general public in a better frame of mind and the new year opened in Chicago with very encouraging expressions of optimism from the leading men of finance and industry.

So far as Chicago architects can foresee there is nothing now remaining in the list of objections to new building activity. A great deal of work is now on the boards and much more in contemplation. The line of prospective activity covers virtually all lines of construction. There are many important office buildings to be erected. Hotel construction will also figure prominently, while the increase in the building of apartments will be unusually great, according to the best predictions. Home building will go forward as never before, owing to the fact that the flat dwellers having felt the lash of the unfeeling apartment landlord are now prepared to venture on homes of their own. The heavy present call for suburban realty indicates that many of these homes will be pretentious and engaging, therefore, the services of many architects.

Industrial building is at present dull and may not show the important revival expected in other lines, but there is a sufficient indication of industrial building need to firm up the prospects in that department, also.

It is interesting to observe the different attitude which the public is taking toward building as compared with its viewpoint on business in general. The man in the street, as well as the business man and the capitalist assumes, as a matter of course, that building will open as soon as the weather permits. Other lines of business are viewed much less certainly in regard to normal resumption. This matter

of fact attitude is one of the very encouraging aspects of the building prospect.

All hands in the industry are fostering this sense of assurance. One of the important contributions to this optimistic propaganda is a pamphlet on the building situation recently issued by the Universal Portland Cement Company. "A period of depression is largely a state of mind" says the pamphlets. "We had one after the armistice. We are experiencing one now." As a panacea for this condition, the pamphlet urges construction, because all factors in the building situation are now favorably disposed toward construction work.

Interest in the "Own Your Home" Exposition to be staged at the Coliseum, March 26 to April 2. Architects in Chicago are particularly interested in contributing to the success of the exposition and under the leadership of Henry K. Holsman of the Illinois Society of Architects, the local members of the profession are doing all that they can to further the Exposition plans. Letters have been sent out to 6,000 architects submitting to them a prize offer for the best architectural solution of the small house problem.

Real estate dealers are of the opinion that the Exposition will do a great deal to stimulate home building throughout Chicago and there has been no lack of co-operation from the realty interests. As a matter of fact, all lines of business interested in home building have assured the committee of complete co-operation and all of the display space has long ago been contracted for by those anxious to exhibit materials and the like.

Charles Bostrom, Chicago's building commissioner, in reviewing the building situation over the last year is not as optimistic, however, as some others. "There is not much hope of a very great renewal of building activities in sight at present" says Mr. Bostrom, "but it is hoped that by spring conditions will have so adjusted themselves that a marked improvement in building operations will be shown."

Mr. Bostrom notes that the building trade continued rather briskly up to May 1 of 1920 and that from that date up to the present activities have declined. During the first eleven months of 1919, building permits in Chicago totalled 6296, while for the same period in 1920 the total was only 3574. The cost of the building contemplated in the 1919 permits up to December 1 was \$95,224,100, as compared with \$73,794,650 for the corresponding period in 1920. December permits are late in being announced, but the final month in the year will show a loss as compared with December of 1919.

Business continues to be dull in lumber and other building materials in this market. Holiday apathy has been felt in all lines and this superimposed upon an already dull market has left the demand very list-

THE AMERICAN ARCHITECT

less. All factors in the lumber and building materials trades, however, are expecting an early beginning of business for the new year.

They also feel that bottom price has been struck for the present both in lumber and in the minor materials.

Prices hold at the levels of previous weeks in practical all items on the lumber and materials list as will be seen by comparing the following prices with those of earlier weeks:

Yellow Pine: B. & B. 1 inch, \$95 to \$130, depending on thickness; 2 x 4, No. 1, 10 to 16 ft. length, \$51 to \$53; 2 x 6, \$48; 2 x 8, \$50; 2 x 10, \$53; 2 x 12, \$55; 13-16 x 3¼ z & b flat flooring, \$85 to \$90; 1 x 6, No. 2 common, \$48 to \$90.

Douglas Fir: 2 4 S, in sizes up to 12 x 12, in length up to 32 feet, \$65 to \$70; 14 x 14, \$68 to \$73; 16 x 16, \$72 to \$75; 18 x 18, \$75 to \$80.

Hard Maple: Four, ¼ No. 1 and 2, \$135; select, \$120; No. 1 common, \$100; No. 2 common, \$65; No. 3 common, \$32.

Birch: Four ¼ No. 1 and 2, \$160; select, \$133 to \$138; No. 1 common, \$95 to \$100; No. 2, common, \$60 to \$65; No. 3 common, \$40.

Red Gum: Four ¼ No. 1 and 2, \$150; No. 1 common, \$90 to \$92; No. 2 common, \$47.

Face brick—

Standard, vitrified red	\$32.00@34.00
Smooth, Indiana red.....	38.00@40.00
Smooth, Ohio red.....	38.00@40.00
Smooth, Pennsylvania red.....	46.00@48.00
Smooth, buff.....	45.00@47.00
Smooth, grey	47.00@49.00
Rough, buff	44.00@46.00
Rough, grey	47.00@49.00
Variegated, rough texture.....	34.00@49.00
	Per M.
Common brick.....	\$16.00
	Per Bbl.
Portland cement.....	\$3.00
	Per Yard
Torpedo—Lake and bank sand.....	\$3.50
Crushed stone, gravel screenings.....	3.50
	Per Ton
Hydrated lime, Ohio, paper.....	\$22.00
Hydrated lime, Ohio, cloth.....	29.00
Includes sacks at 30c each.	

Hydrated lime, Wis., paper.....	20.00
Bulk lime.....	1.75

(Special Correspondence to THE AMERICAN ARCHITECT)

BOSTON, January 10.—The files of the Boston Real Estate Exchange shows that, during the week ending December 19, 1920, there were 391 transfers 210 mortgages aggregating \$1,712,045, as compared to 372 transfers, 199 mortgages aggregating \$1,698,161 for the same week, 1919, and 276 transfers, 149 mortgages (\$838,666) for the like week, 1918.

As more manufacturers have announced wage reductions commencing January 1, far-sighted business leaders see in the rapidity of labor liquidation the promise of productions which will enable manufacturers to turn out goods at prices which will again appeal to the public. Taken from this angle, this past week may be said to have seen a quickening toward the day of better business, but as to actual signs of immediate improvement, they are few.

In some of the primary markets there has been evidence that prices were down to such levels as to attract buyers. In leather, for instance, one of the first commodities to collapse in the period of deflation, some very substantial transactions have recently been reported. In wool it is the same story.

The greatest customers of the nation's industries, the farmers, are at present rather stunned by the rapidity of the decline in their products. They are unwilling to exchange their products, selling on a pre-war basis, for the products of industry which are still far above that basis. With industrial costs down and prices down so that the products of the city may be exchanged for those of the farm on a just basis, one may expect to see greater activity in trade.

Next to the farmers the largest industry in country, the transportation business, is still out of the market for goods. It has always happened that, whenever the railroads started to buy on a large scale, all other lines of business began immediately to quicken and general prosperity followed.

The future of the business situation seems to be closely bound up with getting the farmers, transportation and the export trade back into the commodity markets.

Tabulation of Building Costs

(See Editorial, page 44)

Type of Bldg.	Location.	Type of Construction.	Equipment.	Foundations.	Total Cubic Feet Received	Contract Cost Bid Per Cu.Ft.	When Figures Were Taken.	Remarks.
Court House	Pocahontas, Ia.	Reinforced concrete skeleton; exterior walls stone-faced.	Vacuum steam heat, electric lights; first-class plumbing; push-button electric elevator.	Reinforced concrete.	676,000	\$350,000 51.7c.	1920	Floor construction, terra cotta, arches between concrete joist.
Office	Meggettts, S. C.	Non-fireproof; brick exterior walls; interior construction wood.	Hot-water heat, electric lights; enameled iron fixtures; no elevator.	Mass concrete.	89,040	31,763 35.6c.	Nov. 29, 1920	
Office	Des Moines, Ia.	Reinforced concrete columns and girders; exterior walls brick, backed with terra cotta tile; interior gypsum tile.	Steam heat, electric lights; good plumbing; electric elevators.		1,083,000	642,000 59.2c.	June, 1920	Floor construction metal tile between concrete joist; terrazzo finished floors.
Office for Factory	Woonsocket, R. I.	Non-fireproof; brick walls; wood interior construction.	Steam heat from central plant, electric lights; modern plumbing; no elevators.	Mass concrete.	111,610	59,944 53.7c.	August, 1920	
School	Council Bluffs, Ia.	Reinforced concrete skeleton; walls brick, backed with tile, stone trimming; floors cement and terrazzo.	Steam heat and forced ventilation, electric lights; modern plumbing; no elevators.	Reinforced concrete.	900,000	411,522 45.7c.	May, 1920	Floor construction metal tile between concrete joist.
School	Indianapolis, Ind.	Fireproof; steel and concrete interior construction; self-supporting brick walls.	Vacuum steam, direct and indirect; electric lights; modern plumbing; no elevators.	Mass concrete.	1,900,000	700,000 36.8c.	Jan., 1920	Finished floors, wood-cement and terrazzo; toilet room for each sex on each floor.
School	Dedham, Mass.	Semi-fireproof; walls brick and hollow tile; H. P. joist.	Heating, indirect gravity system; plumbing, first-class; no elevators; electric wiring, in conduit for lights, bells, clocks, fire-alarms, etc.		118,000	63,492 53.8c.	August, 1920	
Hotel	Mason City, Ia.	Reinforced concrete skeleton; curtain walls, brick-backed with tile; gypsum block partitions.	Steam heat, electric lights; modern plumbing; high-speed, electric elevators.		1,777,200	950,000 53.4c.	April, 1920	Floors cement for carpet in rooms; baths tile; public spaces terrazzo.
Hotel	Marion, Ind.	Steel skeleton; walls brick and terra cotta.	Vacuum steam heat, electric lights; bath with every room; 2 electric elevators.	Reinforced concrete.	235,000	200,000 85.1c.	Jan., 1920	Finished floors, cement and terrazzo.
Residence	Sheboygan, Wis.	Non-fireproof; studding brick veneered; hardwood floors on joist; tile bath and vestibule.	Hot-water heat; electric lights not included; 1 bathroom, laundry; kitchen fixtures.	10' hollow brick walls, concrete footings.	32,600	13,705 42.4c.	Nov., 1920	
Residence	Charleston, S. C.	Non-fireproof; frame construction.	Hot-water heat, electric lights; enameled iron plumbing fixtures.	Spread brick.	152,903	35,450 23.1c.	Nov., 1920	
Branch Library	Detroit, Mich.	Fireproof; concrete and steel; floors reinforced concrete; brick walls, stone facing one side.	Heating, vapor vacuum; direct radiators behind metal grilles; indirect lighting; modern plumbing.	Concrete.	152,800	68,846 45.0c.	Nov. 29, 1920	
R. R. Passenger Station	Kansas City, Kan.	Fireproof; brick walls; concrete floors, terrazzo finish.	Vacuum steam heat, electric lights; modern plumbing.	Concrete.	250,000	150,000 60.0c.	Sept., 1920	
Bath House	Kansas City, Kan.	Fireproof; walls stone and brick; floors reinforced concrete.	No heating; no elevators; electric lights; modern plumbing.	Stone.	80,600	36,600 45.4c.	Aug. 10, 1920	
Factory	Chicago, Ill.	Mill construction; 3 stories and basement.	Steam heat, electric lights; automatic sprinklers; elevator; plumbing.		667,000	192,778 28.9c.	1920	
Factory	Indianapolis, Ind.	Reinforced concrete; monolithic floors.	Steam heat, electric lights; little plumbing; 2 elevators.	Reinforced concrete.	1,373,400	260,000 18.9c.	Jan., 1920	Two stories and basement; built to carry 4 more stories, with 2 additional elevators.
Detention Hospital	Dubuque, Ia.	Fireproof; concrete-tile walls; floors reinforced concrete joist; with tile between.	Steam heat, electric lights; modern plumbing; no elevator.	Reinforced footings and foundation walls.	77,847	38,640 49.6c.	Oct. 15, 1920	
Hospital	Indianapolis, Ind.	Steel skeleton; brick walls; concrete floor arches; terrazzo finish floors.	Vacuum steam, electric lights; modern plumbing; bath for each room; 1 electric elevator.	Mass concrete.	485,000	350,000 72.1c.	August, 1920	High-class finish; mahogany and white enamel throughout; built-in baths, etc.

Handwritten text: 110.255-2



CHOIR AND HIGH ALTAR, CHURCH OF SANTA MARIA DELLA SALUTE,
VENICE, ITALY

THE AMERICAN ARCHITECT

VOL. CXIX

WEDNESDAY, JANUARY 19, 1921

NUMBER 2352

Program of Competition for a New Group of Buildings for the New Britain, Connecticut, State Normal School

PROPOSED BUILDING: The State Board of Education of Connecticut proposes to erect a new group of buildings for the New Britain, Connecticut, State Normal School on property facing upon Stanley and Wells streets at New Britain.

PURPOSE OF THE COMPETITION AND AGREEMENT AS TO FEES: The Board, having in hand a sum sufficient for the purpose, desires to secure through this competition preliminary sketches by means of which it may ascertain the probable cost of the accommodations desired, preparatory to the introduction of a bill in the State Legislature to carry on appropriation for the erection of the necessary structure or structures. It therefore proposes to hold a Limited Competition for the selection of an architect to prepare the preliminary sketches and estimate of cost referred to. The competition drawings will be few in number and small in scale with the least possible degree of elaboration in presentation. The winner must be prepared to begin to develop the preliminary sketches in consultation with the Board immediately upon the close of the competition and to complete them as soon after the first of January, 1921, as practicable and not later than February 1, 1921. These preliminary sketches must be of the character usually prepared by architects of those invited in this competition for the purpose of determining the approximate cost of important buildings and grounds; and the successful competitor must be prepared to provide also a water color perspective drawing of the exterior. For the professional services rendered in connection with these preliminary sketches, the scale and number of which are to be determined upon between the successful competitor and the Board, the Board agrees to pay the successful competitor the sum of \$12,000, which shall be inclusive of his fee as competitor and of which sum he shall be paid \$3,000 on account within ten days of the date of the award.

The Board fully expects and intends to employ the

architect successful in this competition to render full architectural service as defined by the American Institute of Architects, but should the Legislature of the State of Connecticut fail to make an appropriation for the purpose of building the structure or structures within three years from January 1, 1921, this agreement to employ the successful competitor becomes null and void. In the event that the State Legislature should subsequently make an appropriation, a new agreement shall be entered into between the State Board and the successful competitor. In either case the \$12,000 already paid him shall be paid and received as a payment on account of the total architect's fee. The unsuccessful competitors shall be paid the sum of \$750, each within ten days of the date of award.

PROFESSIONAL ADVISER: The State Board of Education has appointed as its professional adviser H. Van Buren Magonigle, architect, 101 Park avenue, New York City, to assist in the preparation of this program and to act as its adviser in the conduct of this competition, including the making of the award.

EXAMINATION OF DESIGNS AND AWARD: The Professional Adviser will examine the designs to ascertain whether they comply with the mandatory requirements of the program and will report to the Board any instance of failure to comply with them. The Board agrees that it will satisfy itself of the accuracy of the report of the Professional Adviser and will place out of competition and make no award to any design which does not comply with the mandatory requirements.

The Board and the Professional Adviser will then proceed to the examination of the remaining drawings and will make the award by secret ballot and by majority vote before opening the envelopes which contain the names of the competitors. In making the award the Board and the Professional Adviser will thereby affirm that they have made no effort to learn

THE AMERICAN ARCHITECT

the identity of the various competitors, and that they have remained in ignorance of such identity until after the award was made.

The opening of the envelope containing the name of the author of the selected design will automatically close the contract between him and the Board, as set forth in Paragraph 2 hereof.

EXHIBITION OF DRAWINGS: It is agreed that no drawings shall be exhibited or made public until after the award and that no design shall be made public without the consent of the author.

USE OF FEATURES OF UNSUCCESSFUL DESIGNS: Nothing original in the unsuccessful designs shall be used without consent of, or compensation to, the author of the design in which it appears.

In case the Board desires to make use of any individual feature of an unsuccessful design, the same may be obtained by adequate compensation to the designer, the amount of such compensation to be determined in consultation with the author and the Professional Adviser.

COMMUNICATIONS: (Mandatory) If any competitor desires information of any kind whatever in regard to the competition or the program he shall ask for this information by an unsigned letter on plain paper addressed to the Professional Adviser, and in no other way, and a copy of this letter and the answer thereto will be sent simultaneously to each competitor, but no request received after October 2, 1920, will be answered.

ANONYMITY OF DRAWINGS: (Mandatory) The drawings to be submitted shall bear no name or mark which could serve as a means of identification, nor shall any such name or mark appear upon the wrapper of the drawings, nor shall any competitor directly or indirectly reveal the identity of his design or hold communication regarding the competition with any member of the Board or with the Professional Adviser or with any other person connected with the State Normal School, except as provided for under "Communications."

This program contains all the data necessary to the competing architects as a basis of their sketches and inquiry from miscellaneous sources is futile; the communications of the Professional Adviser with the competitors will therefore be limited to matters of interpretation. The award will be made upon the evidences of general grasp of a problem of this nature exhibited by the sketches. It is understood that in submitting a design each competitor thereby affirms that he has complied with the foregoing provisions in regard to anonymity and agrees that any violation of them renders null and void this agreement and any agreement arising from it. With each set of drawings must be enclosed a plain opaque, sealed envelope without any superscription or mark of any kind and which shall contain the name and

address of the competitor. These envelopes shall be opened by the Professional Adviser in the presence of the Board after the award has been made.

DELIVERY OF DRAWINGS: (Mandatory) The drawings submitted in this competition shall be securely wrapped and addressed to H. Van Buren Magonigle, Professional Adviser, care of Marcus White, President of the State Normal School, New Britain, Conn., in plain lettering and with no other lettering thereon, and be delivered at this address not later than midnight of Monday, November 8, 1920.

PART II.

SITE: The site of the building is shown upon the accompanying survey and the competitors must visit the site before beginning their sketches. All the approaches to the future school will be of practically equal importance. The street car line which now terminates a very short distance south of the southerly line of the property will probably be extended and pass the whole frontage; and the districts east and west of the site will become important in time.

COST: Recognizing that it is impossible in the present condition of the building industry to estimate the cost of a building by any cubic foot rate formerly in use, the Board advises the competitors of its hope that the desired accommodation called for with the exception of the future dormitory may be secured by an expenditure of about nine hundred and fifty thousand dollars and that wasteful planning, excessive heights and an undue degree of elaboration in workmanship or materials will militate against the success of the competitor.

DRAWINGS: (Mandatory) The drawings submitted shall be as follows, at scale given and rendered as noted, and no other drawings than these shall be submitted.

a. A general plan showing the entire property, with present contour lines, with roads, paths, playgrounds and existing or proposed plantations and the new buildings in outline to be at a scale of sixty-four feet to the inch rendered in monotone wash.

b. The several floor plans of the main building, such plans of the dormitory building as required to show dining room arrangements, a front and a side elevation and a section taken at will as best explanatory of the design, at a scale of 32 feet to the inch.

These drawings shall be in pencil, on white paper or tracing paper without shadows, and without any accessories. The plans and sections may have a gray wash on all wall and floor sections. All of these drawings shall be mounted on cardboard (it is recommended that owing to the wear and tear of handling the drawings shall be mounted solid).

DESCRIPTION: A brief description of the design, covering those points not made manifest by the

THE AMERICAN ARCHITECT

drawings and particularly stating the materials proposed, etc.

ARBITRATION: Any difference in opinion between the Board and any competitor arising under this program shall be referred to arbitration, the Board and competitor each selecting one person and these two selecting a third. The decision of two of these persons shall be final and binding upon all parties. The Professional Adviser will not be eligible for selection as one of the arbitrators.

SCHEDULE OF ACCOMMODATIONS: *General.*

Item 1: A main building for administration and instruction.

Item 2: A dormitory to accommodate 100 students, with a few rooms suitable for teachers. Kitchen and dining room facilities.

Item 3: Provision either in main building or in dormitory for a lunch room (for lunches only) to accommodate 200 non-residents in the dormitory. At competitor's option kitchen facilities, but not dining room, may be combined for Items 2 and 3.

Item 4: The design should permit the erection of a second future dormitory in proper relation to the other buildings.

Item 5: An adequate heating plant of flexible character, sufficient for present needs and adapted to expansion, both as to structure and equipment.

Item 6: Living quarters for superintendent of building and grounds, which should include a small garage and a small stable for a horse for use in the grounds, sheds for the storage of tools, etc. At the option of the competitor the heating plant and superintendent's quarters may be either (a) combined in one general structure, (b) or in a small separate group, (c) the heating plant and the living quarters may be in the main building.

Item 7: Four tennis courts and a level grassy area for playground purposes for such sports as basketball, base ball, etc.

MAIN BUILDING.

The figures given are approximate only.

BUSINESS OFFICE: About 400 sq. ft., with office supply closet and sink.

PRINCIPAL'S OFFICE: About 180 sq. ft.

OFFICE OF DEAN: 80 to 100 sq. ft.

OFFICE OF SUPERVISOR OF TRAINING: 80 to 100 sq. ft.

OFFICE OF SUPERVISOR OF KINDERGARTEN: 80 to 100 sq. ft.

RECEPTION ROOM: 80 to 100 sq. ft.

(These require no separate toilet facilities. The two teachers' dressing rooms will suffice.)

A demonstration room on the first floor, with 150 seats arranged in a rising semi-circle, with level space in front for a class of children.

Biology room, about 24x30 ft., sunny exposure.

A library about 50x75 ft., with book shelves in alcoves around same.

A supply room opening out of the library, or adjacent thereto, about 400 sq. ft.

An art room with space for 40 small working tables. Space for supply closets and shelves. This room must have north light, which may be overhead.

An art room annex about half the size of the art room for industrial work, modeling, etc.

A music room for 100 students, so placed as to disturb as little as possible the rest of the school.

About ten recitation rooms, approximating 24x30 ft., and of which two or three should be half this size.

An assembly hall to seat 450, with an inclined floor; a stage about 25 ft. deep, with adequate wings and fair gridiron space above.

A gymnasium, 50 to 60 by 75 to 80 ft., without a running track; spectators' gallery if possible, and outside light.

An office for the physical director.

A room for gymnasium supplies, physical examinations, etc.

A students' sick room, with toilet. This is to be arranged adjacent to the gymnasium, the physical director being in charge of the general health of the students.

A locker room, in connection with the gymnasium, for 250. At least 12 shower baths, 2 W. C.'s, 2 wash bowls.

A teachers' cloak room for 12 women, with wash room and toilets adjacent.

A teachers' rest room.

A dressing room for 6 or 8 male teachers, with wash room and toilet facilities.

Students' (girls) cloak room or rooms, a total of 350 lockers, with proper wash room and toilet facilities. There may be two or more locker rooms at competitors' option with a total capacity of 350.

Janitor's supply rooms, closets, sinks, etc.

Drinking fountains at proper points in the plan.

The following four rooms should be grouped together:

The science lecture room: 100 seats arranged in a rising semi-circle, with demonstration table, suitably equipped.

Laboratory for physics and chemistry to accommodate 40 students.

A work room about 24x30 ft.

A science supply room, about 400 sq. ft.

Factory Production Applied to Housing

Robert Tappan, New York Architect, Addresses National Housing Association

IT has been said that it requires the services of one hundred thousand different workers to satisfy the normal needs of any one individual. I feel that this is an understatement. In our complex civilization the productive forces of the wide world are drawn upon to supply us with what we usually consider the ordinary necessities of life. Food, clothing and shelter naturally form the basic production problems of the entire earth. The National Housing Association is concerned with the last of these.

Nature has been kind enough to furnish to us gratis many elemental food products, ready for consumption. She also provides the material for our clothing; ranging up through several degrees of raw material to partial manufacture. In one climate clothes are obtained from her practically ready-made; in another, clothes do not figure as a prime necessity. But for housing—there we are left to shift for ourselves—and what a mess generally we make of it! Not that there are no good and sufficient reasons for our shortcomings and mistakes.

House building is the oldest craft. We soon outgrew cave dwelling. Perhaps some prehistoric board of health condemned caves as dark, damp, dismal and generally deficient in serving the best interest of the community; or better still, let's imagine that some rapacious landlord jumped the rent or cut down on the heat. At any rate; some one among our early ancestors built himself the first house. It couldn't have been much to look at, but it had the merit of novelty and did not resemble anything else on the street. Immediately, artificial hand-made houses became the vogue. Cave dwelling simply wasn't being done—and so, perhaps, the ancient and still honorable profession of the house builder was born.

Houses are still largely hand-made. It requires the labor of twenty different trades to build a quite ordinary and unpretentious modern cottage. Behind these trades or crafts are lined up literally thousands of skilled experts, each performing some highly developed specialty and each a necessary factor in the successful and economical making of the house. As an architect, nothing has caught and held my imagination more than the realization that every line I draw will tend to set in motion, or keep in motion, some wheel, somewhere, in this gigantic, world-wide machine.

No other necessity in life remotely approaching the dwelling house in importance, is produced today by

so many different skilled hand workers, laboring in the open, at tasks that shift and vary from minute to minute and job to job. Behind these expert field craftsmen are thousands of others who also shift and vary their work to meet the demands of the home builder. My object in this address is to try to tell you how some of this vast machinery can be simplified.

Wood is a basic building material. In one form or another it enters every home. It is living, a growing raw product, that requires only intelligent cultivation to constantly replenish the earth's timber reserves. Lumber production is notoriously wasteful, and its use after production is even more so.

It had been my plan to interest some big lumber producer in manufacturing wooden houses for me right where the trees grew. I believed that many economies could be made in the production of lumber, scientifically standardized to fulfill certain clearly defined purposes.

Lumber, such as is used in ordinary house building, is standardized by trade custom into certain definite sizes, shapes, lengths and grades. The logs are carefully sorted and cut to meet current demands. An average day's run produces 10 per cent. of waste and 15 to 20 per cent. of low grade stock too short to fit the regular standards. Lumbermen conservatively estimate that 10 per cent. of the log, in the form of slabs and trimmings, goes to the burner, because of the lack of demand for short-length material.

Now one-third of the ordinary framing lumber usually used in building a six-room workingman's house can be obtained from material running under eight feet in length. One-half of the expensive finishing lumber used for flooring and dressing up the interior and exterior of the house also can be made from short-length stock. Does it not seem wise to get together with the lumberman with a view to utilizing this discarded, so called, low grade material? I thought so and attempted to do so, but there were a few obstacles in my path.

In the first place, a lumberman is a manufacturer. Now a manufacturer thinks in different terms from an architect, a carpenter, or other professional craftsmen. He speaks a totally different language; using such words as cost, equipment, production, merchandising, credits, transportation, storage, financing, publicity, stock holders, directors, profits—and a host of other terms that were quite new to me. So I found

THE AMERICAN ARCHITECT

it hard to interest him in my very simple idea. Finally, by studying up on some of these unknown words, I was able to get together and sit in with some who listened long enough and patiently enough to get the drift of my thoughts. I found that we had very much in common and that we were not so very different after all. They looked upon themselves as quite as useful and necessary members of society as were professional men. They dared to dream dreams with me and to make plans for the ultimate good of humanity. Only it had to be done in a way they understood—a way that was practical and businesslike.

In theory it had seemed that the producer ought to be able to make up complete consignments of carefully standardized lumber sufficient to construct one house, and he should be able to ship this lumber, packed in a box car, directly to the individual home builder, at a saving to him of at least 25 per cent. The lumber required to construct an ordinary six-room house represents about 35 per cent. of its total cost and the carpenter bill amounts to 15 per cent. more; so in dealing with this subject we are working upon a very important factor in the high cost of home building. It certainly looks as though the producer and the consumer ought to be brought in close contact for their mutual benefit, but unfortunately, it is impossible for the lumber manufacturer to produce economically for direct retail distribution. He must manufacture in large quantities or his whole system of lumber production will be slowed down to an unprofitable pace. This fact, together with orders equally significant in allied industries connected with house building, forced the conclusion that the only way to secure manufacturing economies was to standardize the product, manufacture it in quantities and seek wholesale markets.

Efficient factory production is inconceivable without standardization. Can American dwellings be standardized without sacrificing reasonable individuality? That is debatable. However, we are dealing with a vital necessity of life, that has grown constantly more expensive to supply. Personally, I feel that I could stand any quantity of standardized houses so long as each individual home was attractive in appearance and I knew that its inhabitants were not starving or freezing themselves to death to meet the monthly payments. It has never occurred to me to criticise nature for standardizing her products, or to rail at a field of daisies because they were all white. Why modern men and women, who go out of their way to dress, eat and think alike, persist in housing themselves in structures that represent the styles, modes and whims of every age and clime, is too much for my comprehension. It was not always thus. Can it be that we architects are to blame?

After many months spent in study and experiment, I devised a series of house organisms that combined a reasonable amount of convenience and attractiveness with a fairly economical use of lumber and lumber labor. The floor plans were designed in units, a method that has been in vogue in Japan for centuries. While the Japanese are a nation of individual home dwellers, and famous for the artistry that pervades so many of their products, it is curious to observe that their homes are decidedly lacking in architectural pretension. If there is no attempt at architectural display in the dwellings of Japan the traveller is at least spared those miserable experiences he so often encounters in his own country, where, to a few houses of good taste, he is sure to pass hundreds of perforated boxes embellished with grotesque and offending abominations. From one end of Japan to the other, house plans are designed in terms of a standard unit of measurement, the floor mat. The dimensions of the mat are three feet wide by six feet long. The architect marks on his plan the number of mats each room is to contain—this number defining the size of the room; hence the lumber used must be of definite lengths and the carpenter is sure to find those lengths in the lumber yard. It follows that but little waste of lumber occurs in the construction of a Japanese house. It had occurred to me that an adaptation of this system of unit planning might result in a similar saving in lumber here in America if I could get the lumber producer interested in co-operating. I employed a unit or module of sixteen inches, as that spacing is in common enough use among our carpenters, though generally ignored by architectural designers. This unit, when faithfully followed throughout an entire house organism, permits the use of a few simple standard lengths of lumber that can be used in many places in scores of differently designed houses. The floor, wall and roof boards, for example, may be cut in multiples of four feet, and be nailed in place without waste. There is a technique of unit planning just as there is in playing the piano (its keyboard is only so many units), and the longer I practice at unit design the more valuable the idea proves to be. Next, I carefully scheduled all of the lumber and submitted my complete details to several manufacturers for their estimates. The result was gratifying. Instead of saving 25 per cent., I found that we could lower the cost 50 per cent.

This was interesting, but it is not the whole story. There are other significant savings that can be made. We have found that unit design and standardized wooden construction speeds up the work all along the line. The psychological laws underlying the wonderful manufacturing efficiency of our great modern industrial establishments work out just as truly when they are applied to standardized house

construction. If this paper were not confined to one topic I could tell you of a quantity of experiences that I have had in proving out Ford car production methods on carpenters, painters, plumbers and other house-building craftsmen. There is absolutely no doubt in my mind but that the housing problem, from the point of view of economical production, will solve itself eventually.

Today we are passing through the throes of a great change. A new world is being born. Old, outworn methods are being discarded and new ones are taking their places. There are many who deplore and even resist the onward march of industrial progress. They prophecy the death of all craftsmanship and art. I do not. No one has more respect for the time-honored building crafts than have I. It has been my privilege to be intimately associated with expert craftsmen in many lines on a number of important gothic churches and cathedrals. I have worked

with artists and appreciate the thrills of inspiration and the joy that every true craftsman feels in creative accomplishment, but I firmly believe that the time-honored methods of the house-building crafts, easy-going and haphazard as they certainly are, represent a distinct menace when applied to the construction of this great necessity of life. Food and clothing are no longer produced by mediaeval processes; houses still are, with an added complication, that the modern house is by no means so simple as was its early ancestor. In the old days materials were obtained locally, skilled labor cost next to nothing and mechanical installations were unknown. Today the meanest residence that an enlightened craftsman will inhabit requires the services of thousands of experts to construct. Any new factory production methods that will tend to simplify and lower the costs of modern workingmen's homes ought to be welcomed, not resisted.

The Extension of Paris

A SPECIAL meeting of the London Society was held in the hall of the Royal Society of Arts some time ago to hear a paper on "L'Extension de Paris," by Monsieur Louis Bonnier, Inspector-General des Services Techniques d'Architecture et d'Esthetique (representing the Prefet of the Seine).

After referring to the way in which the great cities had gradually drained the population away from the country, he is reported in the *Architects' Journal* of London, as saying that the advent in our history of these formidable masses of population demanded a new school of therapeutics and surgery. The machinery of the town being much more complex becomes more fragile and at the mercy of the slightest mishap, such as an abnormal flood or an unexpected strike. What would be the position tomorrow if we had masses of population amounting to ten millions of people? He then touched on the history of Paris and the efforts that were made in the time of Phillippe Auguste, Charles V. and Louis XIV, to arrest the growth of Paris by statute. It was only at the end of the eighteenth century that public opinion began to take an interest in the beautification of the city, the first actual plan being prepared by Verniquet in 1790. He then referred to the efforts of the various periods up to the time of Napoleon III., who, with his Prefet Haussmann, dreamed of the complete transformation of Paris. Though these works are still the wonder of the world, yet they have become quite insufficient for Paris of the present day. The advent of the

motor vehicle created requirements which could not be compared with those of pre-war days. At a point where four years ago one horse fiacre passed, now there were perhaps four or five taxicabs. What would be the state of affairs, he asked, when normal conditions were re-established, seeing that France possessed only one motor for every 400 inhabitants, while the United States had one for every 14 inhabitants. Evidently we must be prepared for an enormous increase of motors on the streets of Paris. He suggested that a strict regulation of vehicles would be necessary in the future, and that it would be necessary to consider the suppression of heavy vehicular traffic in the center of the city, the reduction of footpaths for the benefit of the roadway, and even the removal of the stalling of the terraces before the shops and cafes, which give Paris so much character.

A law was passed just before the war that made it obligatory on every town of 10,000 inhabitants and over to prepare a scheme of improvements.

Monsieur Bonnier then described the various studies they had made of the movements of population, etc., in Paris, in order that they might be able to properly consider the probable needs of the future. He mentioned that they had come to the conclusion that it was necessary to include in the City of Paris any neighboring communes with more than 100 inhabitants to the hectare; while of the remaining districts, which they considered as Greater Paris, those where the inhabitants numbered between 10 and 100 to the hectare. He mentioned that though this lowest figure of 10 to the hectare was

THE AMERICAN ARCHITECT

arbitrarily selected by them, they found it was justified by later experiments, and it was an undoubted fact as soon as the figure of 10 per hectare was exceeded then for the first time the influence of Paris began to make itself felt.

The lecturer proceeded to show cinematograph films that he had had made: one showing the successive development of Paris, the other of its suburbs during the course of the nineteenth century. These films have been prepared from plans all drawn to one scale, which show the growth of the city at various stages, then being all run through the cinema quickly they give a graphic idea of the population's increase. The "agglomeration" of Paris covers a total area of 49,483 hectares, bordering on the Department of Oise and Seine-et-Marne. In 110 years the area has increased in the proportion of 1 to 14.4; the population 1 to 7.9. They had tried to find out from their investigations what would be the population of Paris 50 years hence, and came to the conclusion that it would be 14,300,000 in habitants, a figure not more startling to us to-day than would have been the actual population of 1911 to the inhabitants of Paris 50 years earlier.

After referring to the well-known axiom of town-planning, which laid down that it is the public transport services which are the key to the extension of the town and the distribution of its inhabitants, he proceeded to mention the efforts they were making for safeguarding the most precious monuments of the past in the city of Paris. He said that both the French and ourselves belonged to countries the soil of which, in addition to the natural riches, had clothed itself with an incomparable robe of buildings of many descriptions, which constituted a national treasure that it behooved us to safeguard and keep at all costs.

He said that these monuments of the past marked the character of the town and determined the pivot of its embellishment. Though sometimes they were a cause of difficulty to the town planner, yet, like difficulties in other matters, they could be made a pretext and a reason for ingenious and picturesque arrangements. Nothing was so commonplace as the things that arranged themselves too easily. In Paris they were preparing an inventory of all their ancient monuments. After showing various slides illustrating this portion of the work, he went on to speak of the recent Congress and Competition for a Plan of the Future, pointing out that it was im-

possible to undertake the improvement of a city without first having exhausted all sources capable of furnishing suggestions. From the most grandiose schemes or the most fantastic, one could always gain some inspiration. The City of Paris organized an inter-allied Conference to discuss its extension. He referred particularly to the points on which the competitors were unanimous, such as the necessity for reducing immediately the density of the population and bursting through the narrow boundaries which made Paris the most overcrowded of the great capitals. They all agreed, also, that the industrial population should be gradually brought back again to the North of the City, leaving the intellectual quarter to the South; that more radial and circular lines of railways were needed, and they agreed as to the necessity for the electrification of the railways; the removal to a distance of workshops, carriage depots, and to the reconstruction of roads.

Some competitors suggested that the improvements should be secured by driving large and costly avenues from north to south and from east to west: others that similar benefits could be obtained by better organization and stricter regulations, which might be progressively coercive. Monsieur Bonnier intimated that probably a combination of the two would be found to be the best solution. He referred to the immense importance of beautifying the approaches to the city and to the fact that railway stations had now taken the place of the City Gates. Yet was it not a fact that our railway stations were so designed that their most pleasing features were seen not by the coming but by the departing traveller.

Finally he remarked that though many happy ideas were evolved from the competition, yet even in the best schemes there were some deplorable ones. He spoke most strongly against the theory of the isolation of ancient monuments, pointing out that people were apt to forget that they had been designed for the particular position that they occupied. He objected, also, strongly to the idea that it was necessary to surround ancient monuments with buildings that were supposed to be in harmony with them; nor did he consider it possible to rely on the judgment of administrative commissions in these matters. He said that our great architects of the past could never have executed their "chefs d'œuvres" if a dozen serious gentlemen had been charged to lop off the faults with which they were happily endowed.

The Housing Problem Met and Overcome in Prague

(From our Special English Correspondent)

WITH us in England the housing problem seems to firmly decline to be conjured by any motions of the official wand. After innumerable speeches, and complicated and dubious expedients, Dr. Addison, who is officially in charge of this question, has produced a bill which has just been thrown out by the House of Lords, with the general approval of the country, but with the result that it leaves this pressing question in an even worse muddle than it was before. After these years of governmental mismanagement one's heart goes out in sympathy to those who—in the little Sussex village where I write these lines—on the sound old principle that the gods help those who help themselves, set to work a few months ago to build their

ing.” The Municipality of Prague “lent” to them for twenty years the ground required; and soon some two thousand volunteers, all of them students, had started to build a complex of eleven large pavilions, which will provide accommodation and



GETTING TO WORK ON THE FOUNDATION
HOUSING BY STUDENTS AT PRAGUE

own houses, and by this year's ending will have roofed in three or four very cosy looking dwellings on the bungalow type.

But we are by no means the only ones to suffer from housing difficulties. I believe that the problem has crossed the Atlantic; and in Europe Prague, the ancient capital of the new state of Czechoslovakia, has had a very acute housing problem. This was particularly felt by the many thousands of students of the University, who could hardly find suitable lodgings. Here too the idea of self help came forward, and found a ready and efficient acceptance. Professor Zahorsky, of the Technical High School, placed at the disposal of the organizations of the students his own patented system of “rapid build-



MOVING THE SOIL
HOUSING BY STUDENTS AT PRAGUE

comfortable conditions for 700 students. These will include a central kitchen, dining-hall; laundry, reading-room, etc. The students, as will be seen in one of my illustrations, have themselves dug the foundations for these pavilions, they had even dynamited



MOVING UP MATERIAL
HOUSING BY STUDENTS AT PRAGUE

stone in the quarries, and in fact have, I understand, done the whole work—with the exception of the brick-laying, which was done by professionals.

THE AMERICAN ARCHITECT

I am told by my friends in Prague that it is very interesting to visit this busy active colony, and see them at work—especially on Saturdays and Sundays, when some 400-500 are to be found working.



CARTING THE STONE
HOUSING BY STUDENTS AT PRAGUE

By an excellent regulation the right to get a room in this colony is only acquired by those who have worked at least 70 hours on the construction. The colony is situated in the modern part of the city, near

the Stadium, where last summer the great display of the Sokol gymnastic societies took place; and the girl students do the cooking for their working comrades, that is, for those who are actually working on the construction. The whole movement only commenced some 5-6 weeks ago, and by this time all the eleven pavilions are about completed and occupied by the students.

The system of "rapid building" which Professor Zahorsky has so generously placed at the disposal of the students has the advantage that very solid buildings, with quite a good appearance, can be built of wood, with stone foundations and brick undersettings, without any specialized knowledge of carpentry, for the planks are only nailed together. Our illustrations, which show the students at work, will help in forming some idea of the methods of construction used. The buildings have double walls, with a sort of small ladders between, and the walls are filled with ashes so that the pavilions will keep warm. The result should go far to test, and very possibly establish, the advantages of the method here put in use. In any case, after such interminable discussion, it is a pleasant change to find some people who can take off their coats, and put the work clean through in six weeks.

The American Specification Institute

FROM an examination of your editorial of November 17 it appears to us that your plan for the American Specification Institute is a good one. We do not know that specifications as now produced are the least creditable portion of the output of an architect's office. While we see other architects' work as published in the magazines we never see another architect's specifications and seldom see any of his detail drawings. We sometimes hear criticisms of other architects' specifications from contractors who use them and have even heard favorable comments on our own.

It would seem to us that if some arrangement could be found by which our specifications could be criticised by some impartial, disinterested architect, or, even better, by such a contractor, it would be of very great benefit.

HARDING & SEAVER.

Pittsfield, Mass.

I am very much impressed with your suggestions and wish you every success, and would be glad to help.

MYRON HUNT, Architect.

Los Angeles, Cal.

We heartily endorse the formation of the American Specification Institute, about which you write

in your editorial November 12. If, as you say, it is wisely formed and managed, it should greatly assist in improving this branch of architectural and engineering work, which, we must agree, is generally not given the attention it deserves.

We await with much interest further information regarding progress of this movement.

SMITH, HINCHMAN & GRYLLS.

Detroit, Mich.

I quite agree with your view that as a rule the specifications now produced are the least creditable portion of the output of architects' offices, and, holding this opinion, I therefore feel that anything that is likely to improve the character of specification writing and any institution that will turn out men competent to write good specifications should be welcomed by the architectural profession as a whole and certainly would have my hearty approval.

The proposed Specification Institute may be the very organization to handle this work. I am not sure that I understood its purposes and equipment sufficiently to give it unlimited commendation, but, if I understand it correctly, I shall certainly wish for its abundant success.

WILBUR T. MILLS.

Columbus, O.

Trinity Church, Newport, R. I.

(See reproduction of original drawing by O. R. Eggers on opposite page)

Newport, Rhode Island, sometimes called the social capital of the United States, was even before the outbreak of the Revolution socially and industrially important. During the occupation of Newport by the British, a fire destroyed a large part of the town. Among the few structures to escape the flames was Trinity Church, the subject of this sketch. As a result of military operations Newport became almost depopulated, but through all the vicissitudes of the Revolutionary struggle, "old Trinity" passed safely.

In its architecture Trinity resembles many other churches built in New England during the early history of the Colonies, and while preserving the dignity and quiet refinement that characterized the early meeting houses, its chief claim is its association with stirring scenes of early wars and the reverential aspect of the people who stoutly guarded this sacred building from every threatened danger.

Old Newport presents a picturesque contrast to the newer section, where now the mansions of the newly rich flaunt their pride of wealth before the observer. In the old town the houses are small, wooden structures, the streets are quaint and narrow and there is a restful feeling about the entire section.

In earlier days the waterfront was the scene of bustling activity. Newport is an ideal harbor for ships of even the largest draft. From this port there cleared to sail the waters of the seven seas tall sparred ships whose cargoes formed a considerable part of our American commerce. At that time the spire of Trinity dominated the town and it served as a landmark for incoming ships and a beacon of hope to the home-coming sailor.



C. R. EGGER
NEWPORT

TRINITY CHURCH, NEWPORT, RHODE ISLAND
THE AMERICAN ARCHITECT Series of Early American Architecture



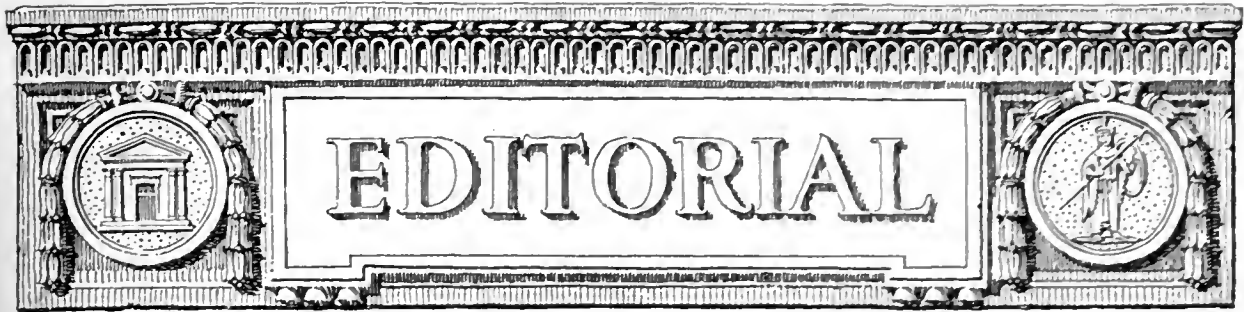

Europe Turns to American Architects

AN increasing respect for American architects is being manifested by the attitude of Europe. Visitors to these shores from abroad reverse the opinion expressed by foreign guests some thirty years ago. At that time it was generally recognized that American architecture in the finer and accepted sense, did not exist in our promiscuously grouped skyscrapers, which in themselves were ugly.

But today it is different. Arthur Balfour, during his recent trip to this country, referred with unrestrained admiration to "these great cathedrals which you call business buildings." Blasco Ibanez when he was here, declared that in the presence of New York's skyline and the magnificence of its great structures, he felt "a new pride in the achievements of man."

Today America leads in architectural development. The Philadelphia *Ledger* summarizes certain instances of dependence upon us for the restoration of Europe's war-marred places. An American has been asked to plan the restoration of Rheims. An American architect has been invited to rebuild the University of Louvain. And greater yet, one of the largest problems confronting European specialists, the planning of a new Constantinople, has also just been referred to American architects.

These few examples indicate a tendency, but it is logical to assume that only competence has been the basis. If American architects had not made good, not only in America where our own prejudice might discolor merit, but in the opinion of unbiased nations across the seas, the situation would be quite different. It is the practical grasp of the business of architecture, combined with a close knowledge of architecture as an art, that is more and more bringing recognition to the profession, and by a harmonious union of these two attitudes will the profession move onward to an ever better standard.

What Is a "Public"?

PEOPLE are naturally egotistical. No better proof of this can be found than our attitude toward strikes and the "public" which those strikes

effect. Forget entirely about the right or wrong of a strike. Take it for granted that a strike exists in a municipal street railway system. That is a so-called public utility. As a matter of fact, it is no more a public utility than the hotel one stops in, the restaurant one eats in, or the house one lives in. We have become accustomed to speaking of it as a public utility in a loose sense, and we probably shall continue to do so for a long while.

Precisely as we speak of "the public" in a loose sense in the event of a strike on a traction system. Also, in a selfish and egotistical sense. We find that we cannot get down to work. We are inconvenienced. We have to resort to various makeshifts to reach our place of business. We immediately speak of "the public," which means simply that we are speaking of ourselves and others who want to get down to work on that particular traction system. That is "the public" for the time being.

If cooks go on strike, the owners of restaurants set up a wail about the "public" being hard hit. They are thinking and speaking *only* of restaurant owners. It matters little to them if steel erectors are also on strike, so long as such a strike does not immediately and directly affect restaurant owners as a whole.

So it goes. The "public" is always nothing more than ourselves.

One of the best things ever said about the too-often quoted "public" is this by Albert Strauss, formerly Vice-Governor of the Federal Reserve Board:

"The workmen of each manufacturer and producer are the customers of all manufacturers and producers. The great bulk of the working population constitutes the great bulk of the customers of the producers and manufacturers. Unemployment, therefore, tends to perpetuate itself by cutting off the purchasing power of the population; the more that purchasing power is curtailed the more does business fall off, and the more business falls off the more, through unemployment, is the purchasing power of the community impaired."

Careful consideration and study of that paragraph would eliminate a great deal of useless and inane talk about "the public." It would not excuse unjustifiable

strikes. It would not mean that strikes are right or wrong. It would simply tend to do away with some of the natural egotism which is unfortunately too great a part of every member of the real public.

Excessive Bidding

CONTRACTORS do not make bids in any way comparable with those made after the work is ready to start and the owner ready to buy. This gives the impression that buildings *will* cost more than they actually do cost. Hence the owner decides not to go ahead . . . Stabilization of prices and the revival of building will be here when the contractors are ready to quote their *real* prices, so that investors can see their way clear to go ahead and not feel that they are paying a premium to the juggling of prices by contractors."

This paragraph occurs in a letter from one of our correspondents, and is a quotation from a recent interview with one of the country's most prominent architects, a man directly in touch with the administrative affairs of several architectural societies and constantly on the alert to the various factors which operate to the good or evil of the building industry.

Two examples will suffice to show just what this practice means to the building industry. A 20-story building, on which figures were taken recently, was to have seven passenger elevators. They were bid at about \$225,000. In another job (a bank building) 14 stories high, and with steel to carry 20 stories, was let at "\$1 per cubic foot," according to information given out to the public.

Now as to the first instance. The bid for these elevators was outrageous; almost 100 per cent. too high. Proof of that fact was shown in the action of the elevator company which made the bid. A week after the original bid was submitted a representative of the elevator company which made it called, and said just about this:

"If this building operation goes ahead, we can materially cut the price and close the contract."

Moreover, the steel was bid at \$110 per ton, which is in excess of the cost now being used in a building now being constructed in the particular city where all this occurred.

"Contractors," says this same architect, "seem to be afraid to make bona-fide bids. Afraid they might bid too much lower than their competitors. I know how that is from my own experience. Everyone sparring for wind and playing for position."

So much for the first example of this practice.

The second—concerning the cubic foot cost of the bank building referred to—has to do more properly with misinformation rather than with excessive bidding, but it creates an impression of excessive bidding, and is therefore to be spoken of at one and the same breath.

What that \$1 per cubic foot *actually* represented in that bank building was practically a total cost, since it included all of the marble and bronze bank fixtures, vaults and other expensive items of a bank, but not, by any means, part of an ordinary office building.

Yet the public, or even architects, who may not have known the real facts of the case, were given the impression that the building itself cost \$1 per cubic foot.

What is the value of getting at facts like these?

Simply this: To recognize a condition, produce examples of it based on facts, and then seek a remedy. There can be no doubt that excessive bidding exists. The facts given here are *typical* instances, not detached incidents. They point the necessity for a remedy.

What shall that remedy be? It has been pointed out time and again at conventions of architects, of engineers, of builders, and of every group which has to do with the building industry. It has been repeated so much, and so vociferously, that it has become tiresome to a great many architects. Yet it is the *one* remedy for the thing, and it is summed up in one short word.

It is needless to print that word.

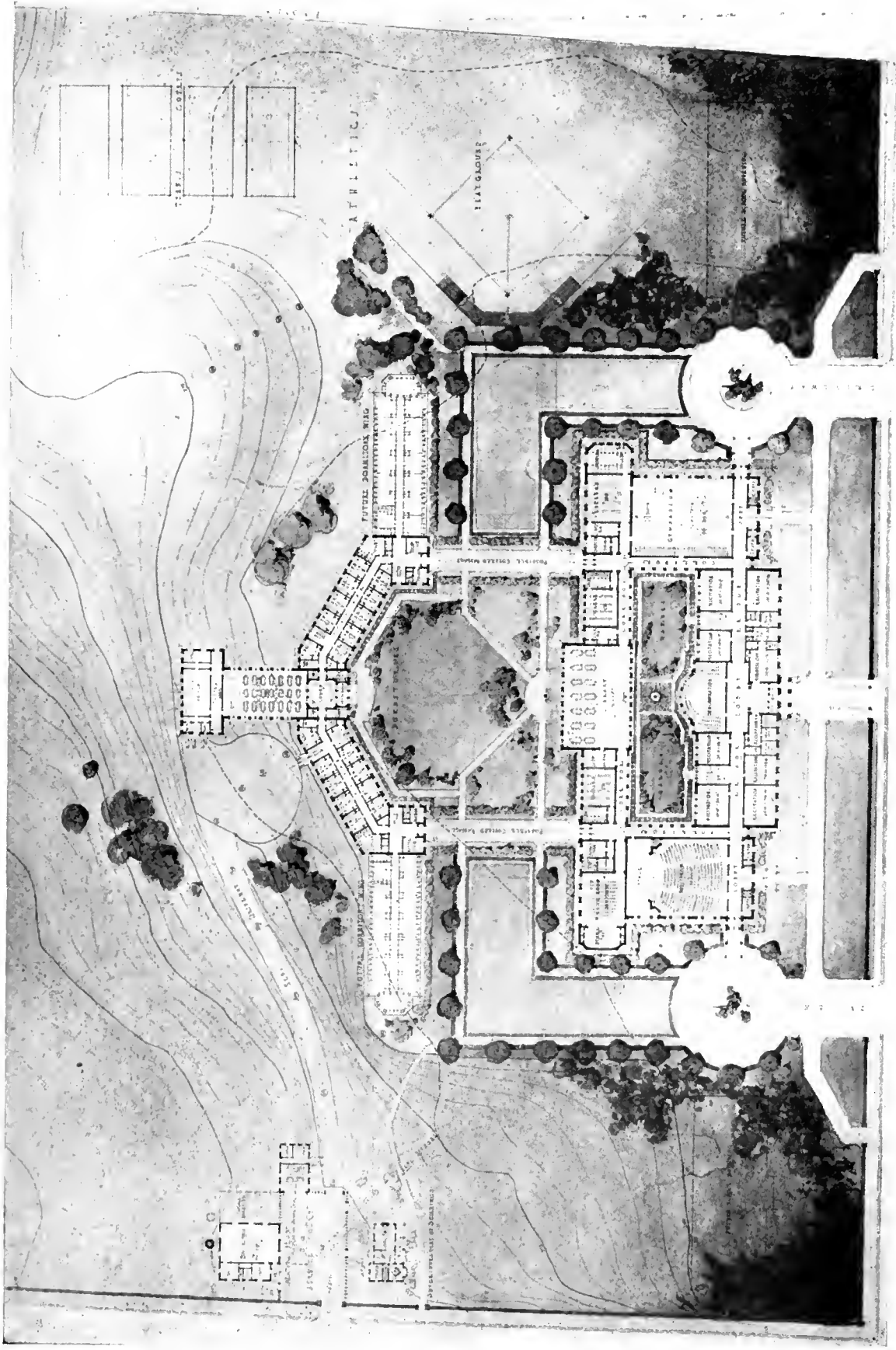

PLOT AND FIRST FLOOR PLANS
 COMPETITION FOR THE STATE NORMAL SCHOOL, NEW BRITAIN, CONN.
 PRIZE WINNING DESIGN—GUILBERT & BETELLE, ARCHITECTS

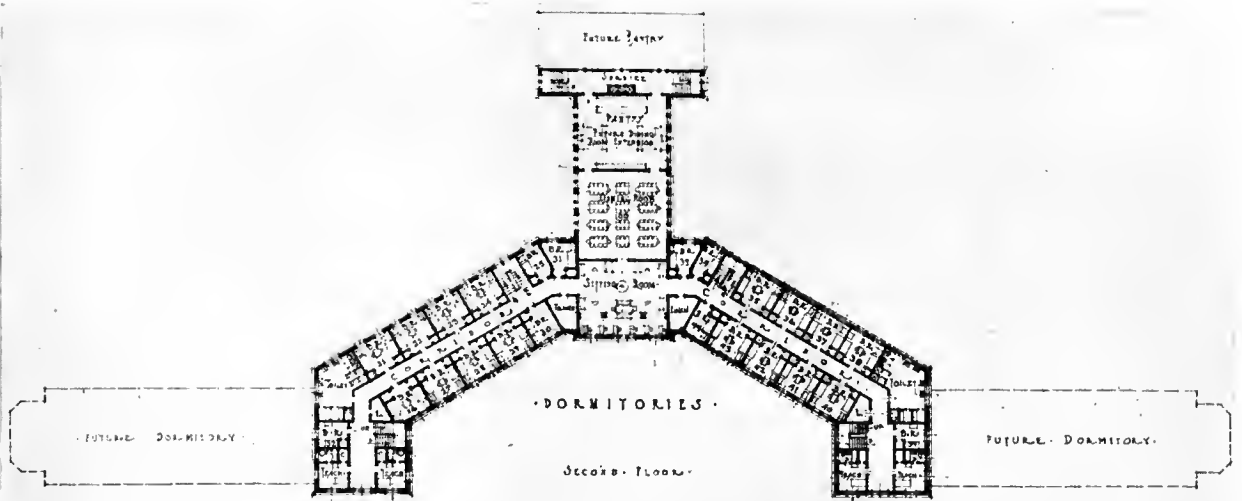

STUDENTS -

FIRST FLOOR	20 ROOMS	= 40 BEDS.
SECOND FLOOR	16	= 32
	A	= B
THIRD FLOOR	20	= 20
TOTAL		100 BEDS.

TEACHERS -

FIRST FLOOR	2 ROOMS
SECOND FLOOR	4
TOTAL	6 ROOMS

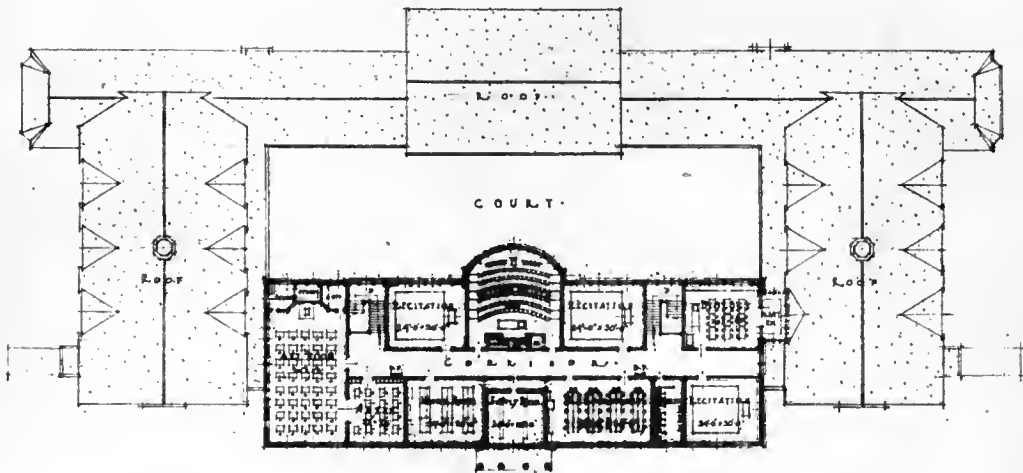

MAIN BUILDING
Second Floor

SCALE - 1/32" = 1'-0"

COMPETITION FOR THE STATE NORMAL SCHOOL, NEW BRITAIN, CONN.
PRIZE WINNING DESIGN—GUILBERT & BETELLE, ARCHITECTS

COMPETITION FOR A NEW GROUP OF
BUILDINGS FOR THE NEW BRITAIN
CONN. STATE NORMAL SCHOOL

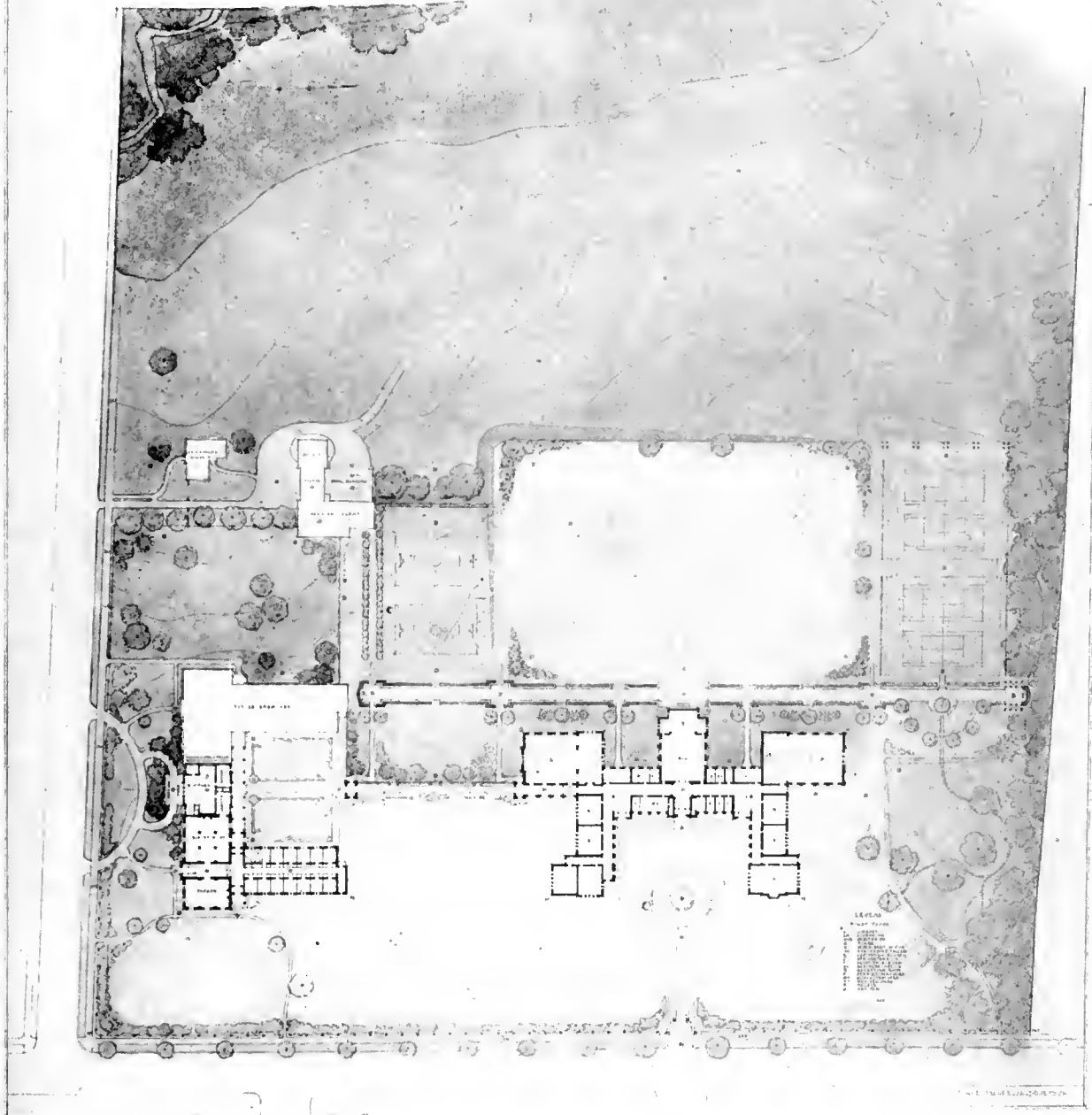

PLOT AND FIRST FLOOR PLANS
COMPETITION FOR THE STATE NORMAL SCHOOL, NEW BRITAIN, CONN.
DESIGN SUBMITTED BY W. F. BROOKS, ARCHITECT

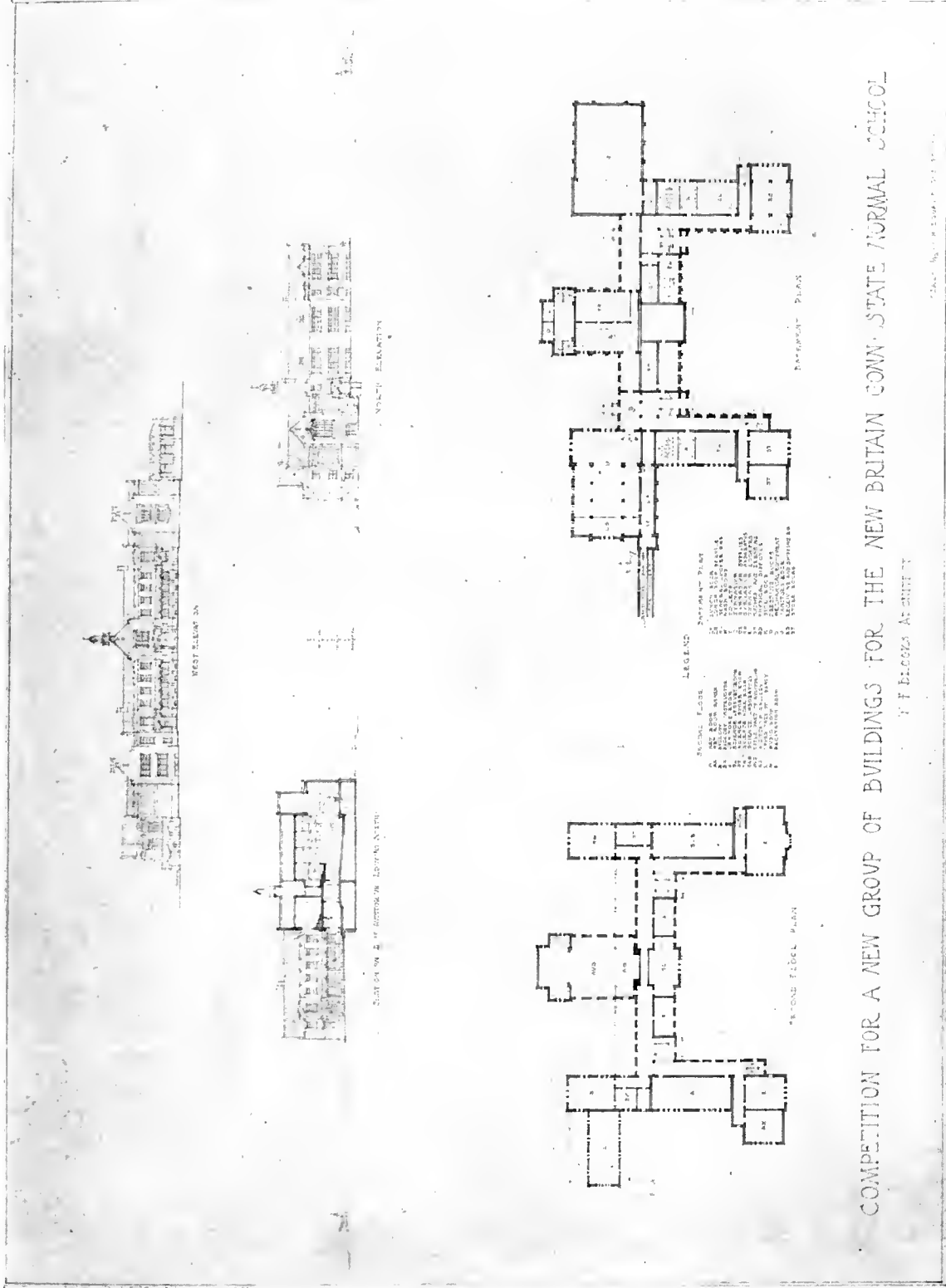

COMPETITION FOR A NEW GROUP OF BUILDINGS FOR THE NEW BRITAIN CONN. STATE NORMAL SCHOOL

COMPETITION FOR THE STATE NORMAL SCHOOL, NEW BRITAIN, CONN.
DESIGN SUBMITTED BY W. F. BROOKS, ARCHITECT

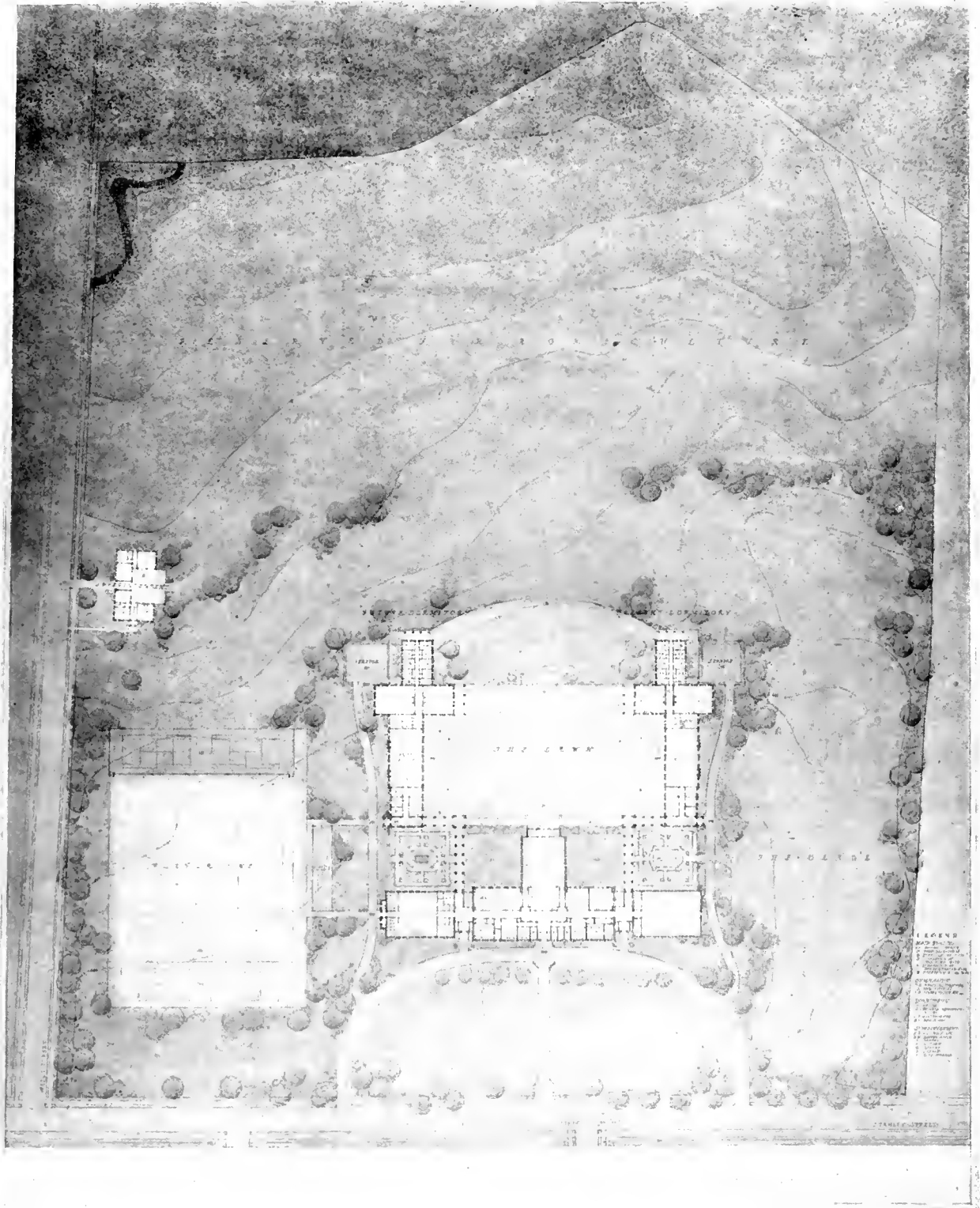

LOT AND FIRST FLOOR PLANS
COMPETITION FOR THE STATE NORMAL SCHOOL, NEW BRITAIN, CONN.
DESIGN SUBMITTED BY AYMAR EMBURY II, ARCHITECT

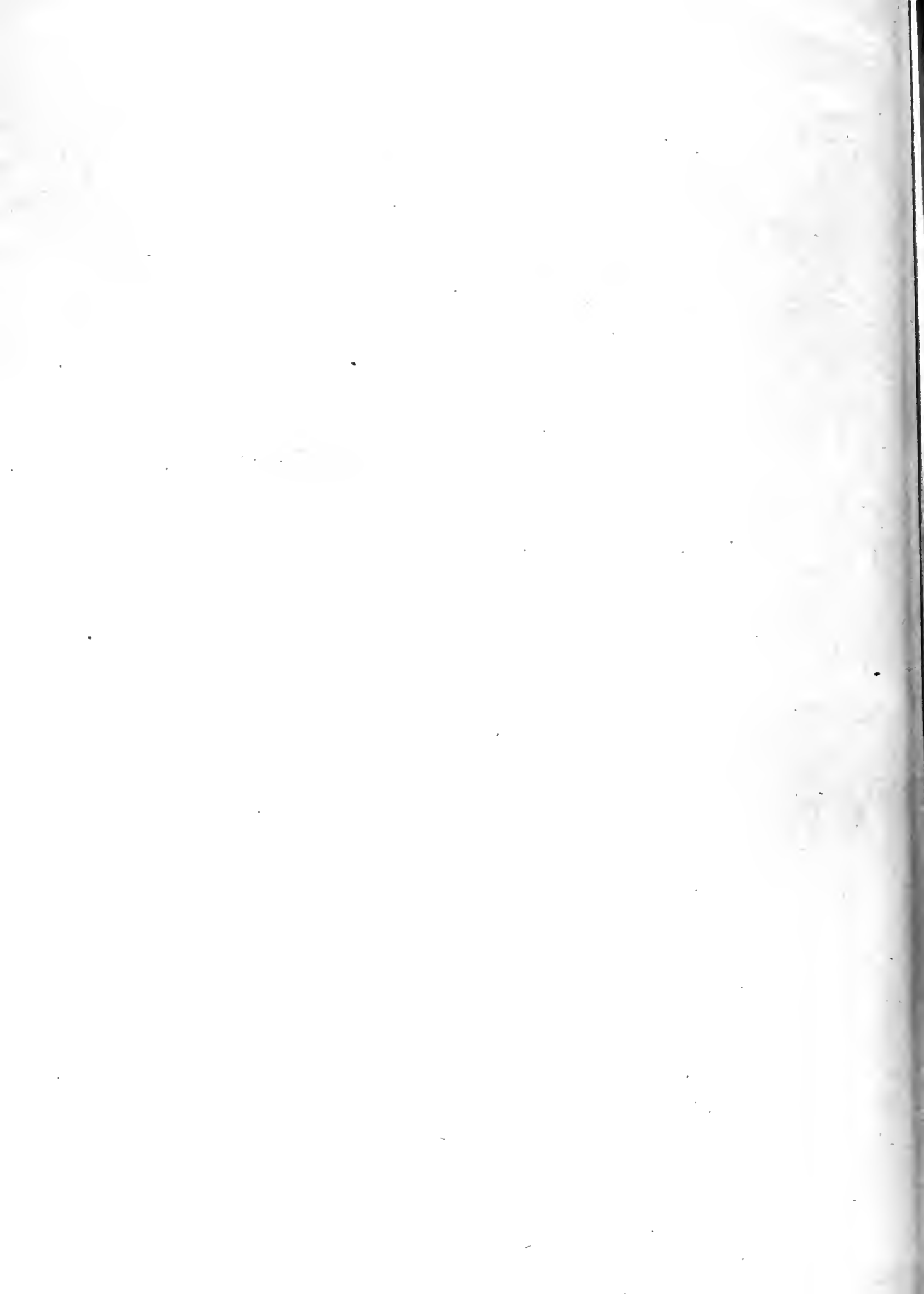

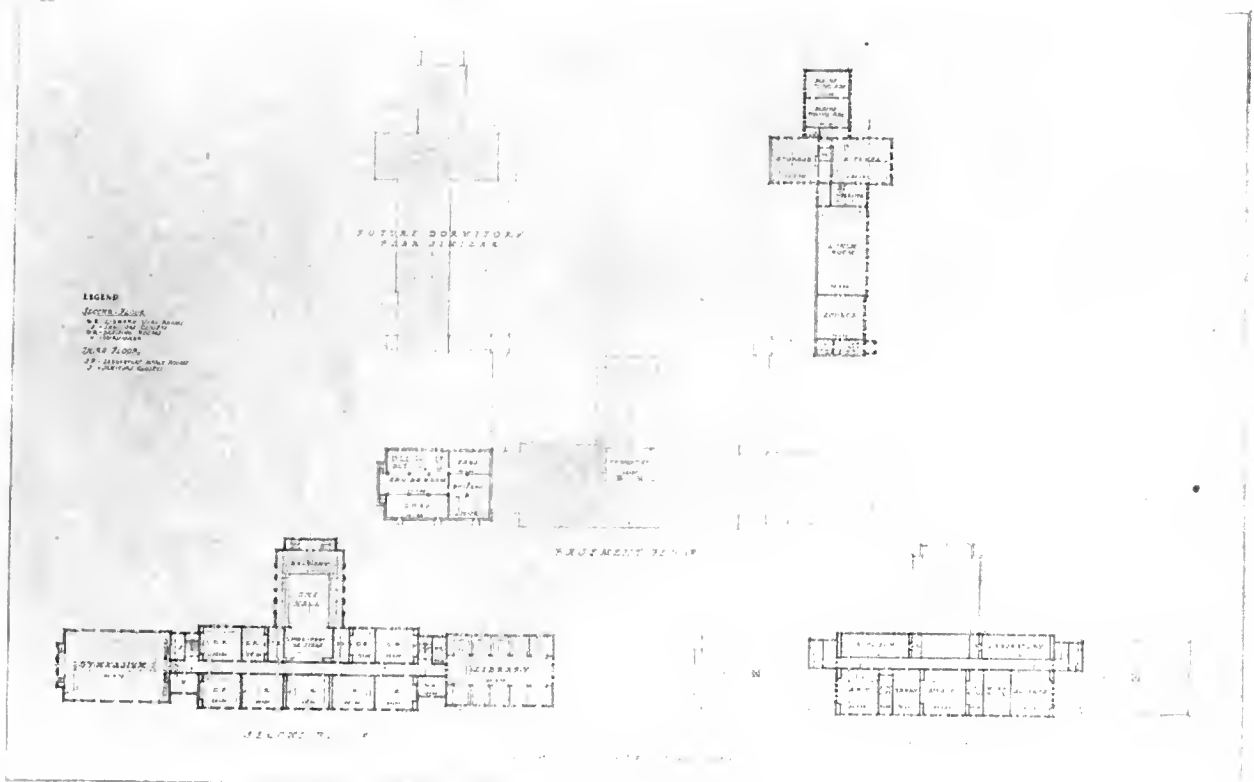

COMPLETION FOR A NEW GROUP OF BUILDINGS FOR THE NEW BRITAIN CONNECTICUT STATE NORMAL SCHOOL

COMPETITION FOR THE STATE NORMAL SCHOOL, NEW BRITAIN, CONN. DESIGN SUBMITTED BY AYMAR EMBURY II, ARCHITECT

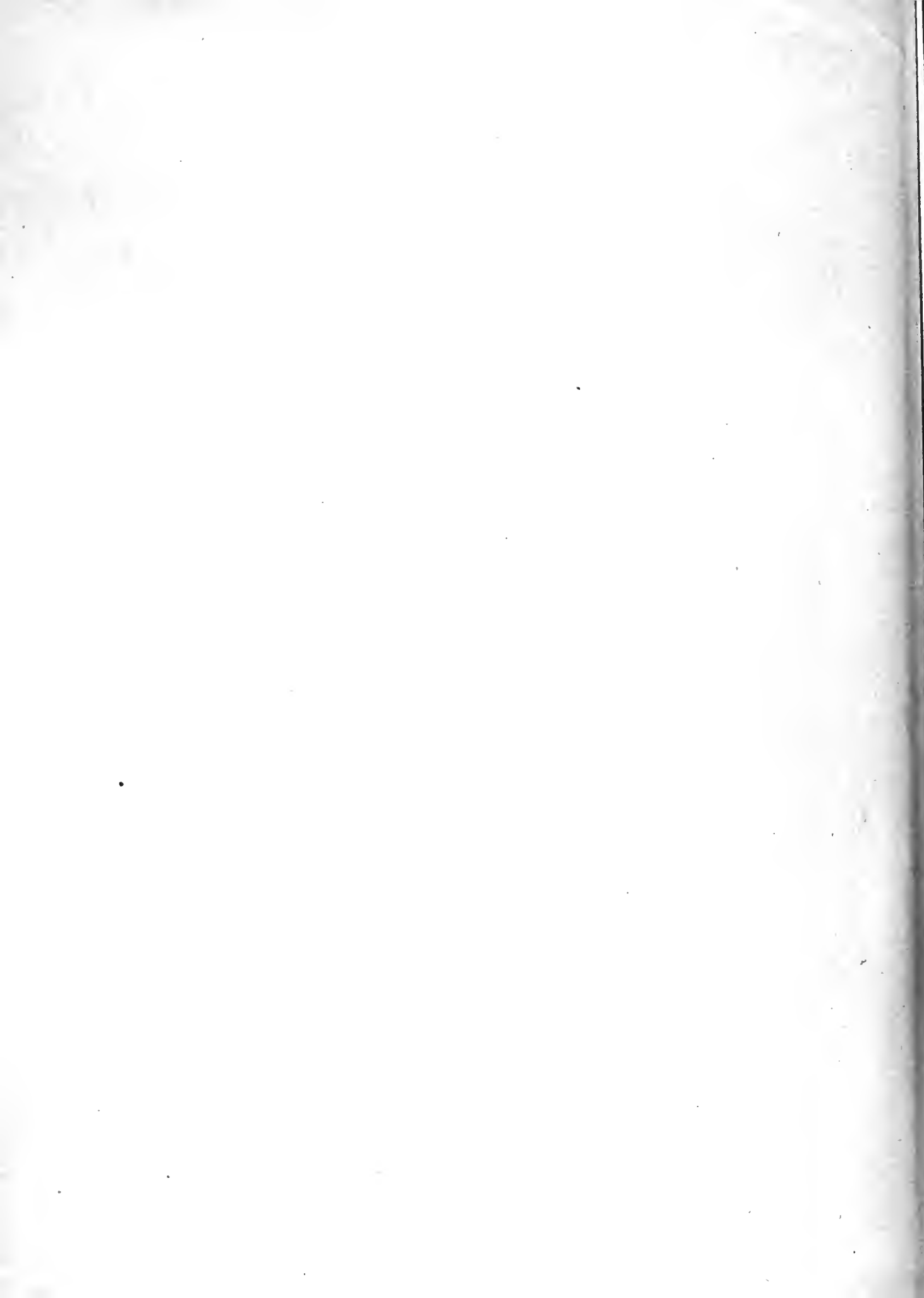

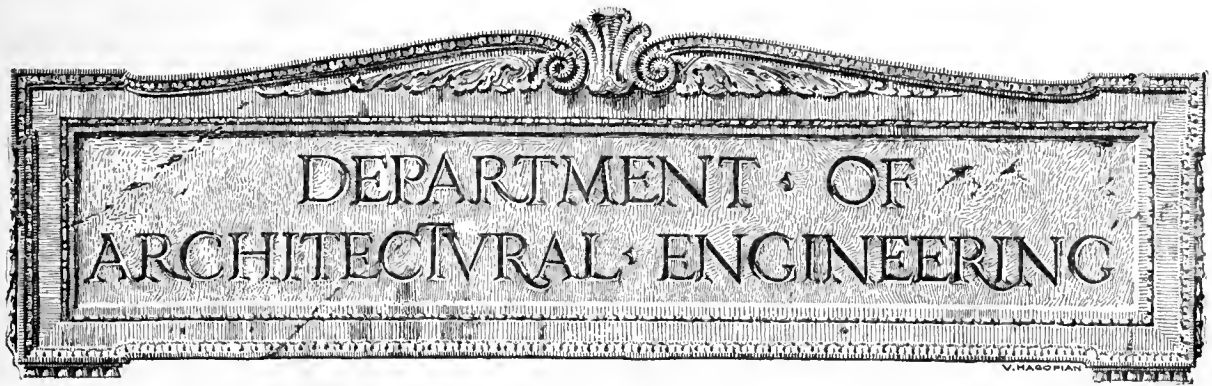

Heating and Ventilating Industrial Buildings

Part III

Hot-Blast Systems

By CHARLES L. HUBBARD, Heating Engineer.

THE most satisfactory system of heating for the modern industrial building, especially where the number of occupants is large in proportion to the cubic space, is that employing a fan and heater with a system of ducts for distributing the warm fresh air to all parts of the building.

Various modifications of this arrangement are employed for different conditions, including the recirculation of air; the unit system, without the use of distributing ducts; a combination of supply and ex-

haust fans, etc., etc., which will be mentioned in some detail later on.

While a certain amount of simple data relating to the design of systems of this kind will be given, the plan proposed is to make this rather brief and devote the greater part of the article to the general arrangements which have been found most satisfactory for different classes of buildings, thus assisting the architect in making a selection of a system for any given set of conditions.

FANS

The fans used for hot-blast heating are almost entirely of the centrifugal type, enclosed in steel plate casings. They are of two general forms known as the "paddle wheel" and "multi-vane."

The first of these is the older, and is probably more widely used than any other, although it is being rapidly superseded in new work by the multi-vane fan, owing to the smaller size of the latter for a given capacity and its higher efficiency.

The paddle wheel fan has been more or less standardized in design by different makers so that general data is of some value for approximating the size, speed and horse power, under given working conditions.

The multi-vane fan, on the other hand, varies considerably in design and operation, hence it is best to obtain all data as regards its action from the makers for any particular case under consideration, furnishing them with the volume of air to move, and a rough sketch of the size and arrangement of the distributing ducts.

In a general way, the cubic space required by a

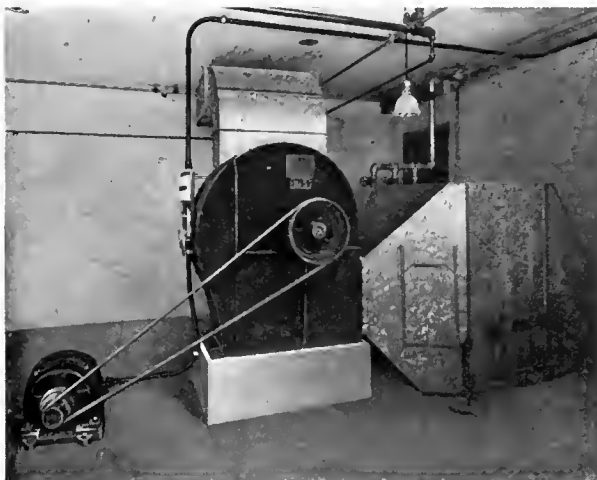

MODEL INSTALLATION IN BASEMENT OF
INSTITUTE OF THERMAL RESEARCH,
BUFFALO, N. Y.

Vento heaters are located inside the galvanized housing, warming air forced through by electrically driven fan.



BUFFALO PLANT OF NATIONAL LAMP WORKS

Note method of running air supply ducts.

multi-vane fan will be approximately one-half to two-third that required by a paddle wheel fan of the same capacity, and for the same size outlet will deliver the same volume of air at about 65 per cent. of the tip speed, and will require approximately 80 per cent. of the power.

DATA FOR PADDLE WHEEL FANS

For fans of average proportions, the volume of air moved may be computed by the following formula:

$$V = 2 \times D \times N \times A \times B; \text{ in which}$$

V = cubic feet of air discharged per minute.

D = diameter of fan wheel, in feet.

N = revolutions per minute.

A = a factor depending upon the diameter of fan. (See Table I.)

B = a factor depending upon the resistance produced by the air ducts. This may be taken as 0.6 for the condition found in shops and factories when the duct arrangement is as shown in Figs. 1 and 2, and 0.7 for systems like Figs. 3, 4, 5 and 6. (See Editor's Note.)

If the size and volume of air are given, the

speed may be obtained by the following, in which the symbols are the same as before:

$$N = \frac{V}{2 \times D \times A \times B}$$

TABLE I.

Diameter of fan, in feet	Value of "A" in formula
3	2.9
3½	3.9
4	5.0
4½	6.2
5	7.6
6	10.7
7	14.4
8	18.6

EXAMPLE

What volume of air will be delivered per minute by a 6-foot fan running at 300 r.p.m. in connection with a shop system of the general type illustrated in Fig. 1?

$$V = 2 \times 6 \times 300 \times 0.6 \times 10.7 = 23,112 \text{ or } 23,000 \text{ cubic feet, in round numbers.}$$

The horse power for driving a fan depends upon



NOVEL INSTALLATION IN FORD MOTOR CO. PLANT

In this case the columns have been utilized as ventilating ducts.

the diameter, speed and the resistance operated against. Table II gives data from which the horse power may be approximated. The figures in the table are for fans discharging directly into the atmosphere without the use of ducts.

For the conditions of factory work, multiply these figures by 0.7 when "B" in the formula = 0.6; and by 0.8 when "B" = 0.7.

TABLE II.

Dia. of fan, in feet	Revolutions per minute											
	160	200	240	280	320	360	400	440	480	520	560	600
3								3	3.5	4	4.5	5
3½						3.5	4.5	5.5	6.5	7.5		
4					5	6.5	8	10	12			
4½				6	8	10	13					
5			7	9	12	16						
6		10	14	20	27							
7	12	16	25	33								
8	18	30	49									

EXAMPLE

What horse power will be required to drive the fan considered in the previous example?

Here we have a 6-foot fan running at 300 r.p.m., with a value of "B" = 0.6. From Table II we find that a fan of this size running at 280 r.p.m. requires 20 H. P. and at 320 it requires 27 H. P. Interpolating, we find that for 300 r.p.m., the horse power will be

$$\frac{20 + 27}{280 + 320} \times 300 = 24 \text{ horse power.}$$

FAN DRIVES

Ventilating fans may be driven either by steam engines, turbines, or electric motors, according to circumstances. When the exhaust can be utilized

in the heater, an engine or turbine is usually more economical to operate where it is necessary to vary the fan speed to any great extent during different parts of the day. Where electricity is generated on the premises, motors are usually employed for all fan work, especially where ventilation is provided throughout the year, regardless of heating, and where the exhaust from the engine would be wasted during the summer.

Again, the convenience of a motor often leads to its use, even at an increased cost of operation.

A simple, quiet-running engine is desirable for fan work, and may be either horizontal or vertical, as found most suitable. The matter of a belted or direct drive is also one of available space in industrial buildings, and either may be employed satisfactorily. Engines having the crank and connecting rod encased are especially adapted to this class of work, as it protects the bearings from dust and grit which are liable to be present to some extent when the engine is placed in the fan room.

Since it is frequently desirable to connect the motor directly with the fan shaft, direct current is preferable in ventilation work. When this is not available, and alternating current must be employed, it becomes necessary to use a belted or geared motor in order to secure the required speed reduction.

HEATERS

The radiating surface used in connection with blower work may be either in the form of wrought iron pipe or cast iron sections designed especially for this purpose. In either case, standard forms are generally employed so that the work of the architect



PORTION OF THE PLANT OF THE BEECH NUT PACKING CO., CANAJOHARIE, N. Y.

In heating buildings in which food products are prepared, not only fresh air, but that free from dust, and of proper humidity is essential. In the plant shown above the air is both washed and heated before delivery. In addition the humidity is under careful control.



HOT-BLAST SYSTEM INSTALLED IN PRINTING ESTABLISHMENT

This press room is both heated and ventilated by fresh warm air supplied through the register openings.

or engineer relates rather to their arrangement than to details of design.

The quantity of heat given off varies with the depth, the amount of surface, the velocity of air flow over it and the difference in temperature between the air and the steam filling the heater. The final temperature of the air depends upon the *depth* of the heater rather than the *amount* of surface.

For average conditions, say, with steam at 2 pounds gauge pressure, air entering the heater at zero, and passing through it at a velocity of 1,000 feet per minute, the final temperature will be approximately as follows for heaters of the depths listed.

TABLE III.

Depth of heater, in rows of 1-inch pipe	Final temperature of air passing through heater
4	30
8	60
12	85
16	105
20	122
24	137

The efficiency of the heater, or heat units given off per square foot of surface per hour, for different depths is given in Table IV, which is based on the same conditions as before; that is, air entering at zero, velocity of air 1,000 feet per minute, steam pressure 2 pounds gauge.

The working formulae for the design of main heaters are very simple, and are as follows:

$$H = \frac{V \times T}{55}; V = \frac{55 \times H}{T}; \text{ and } T = \frac{55 \times H}{V}, \text{ in which}$$

H = total heat to be supplied, in thermal units.
V = cubic feet of air to be heated.

T = rise in temperature of air, in degrees.

TABLE III.

Depth of heater, in rows of 1-inch pipe	Efficiency of heaters, in thermal units per sq. ft. of surface per hour
4	2,200
8	2,000
12	1,800
16	1,600
20	1,500
24	1,400

The use of these formulae and Tables III and IV are best illustrated by working a practical example.

EXAMPLE

A factory building contains 240,000 cubic feet of space, and it is desired to change the air three times per hour when it is zero outside, and maintain an inside temperature of 70 degrees at the same time. The maximum heat loss through transmission and leakage is computed as 600,000 thermal units per hour by methods previously given. How many square feet of surface must the main heater at the fan contain, and how many rows of pipe deep must it be?

The total heat to be supplied per hour is that required to warm the incoming air from zero to 70 degrees, plus that lost by transmission and leakage. The total air quantity is 240,000 x 3 = 720,000 cubic feet per hour. To raise the temperature of this through 70 degrees requires

$$H = \frac{720,000 \times 70}{55} = 916,400 \text{ thermal units.}$$

Adding to this the loss by transmission and leakage gives a total of 1,516,400 thermal units per

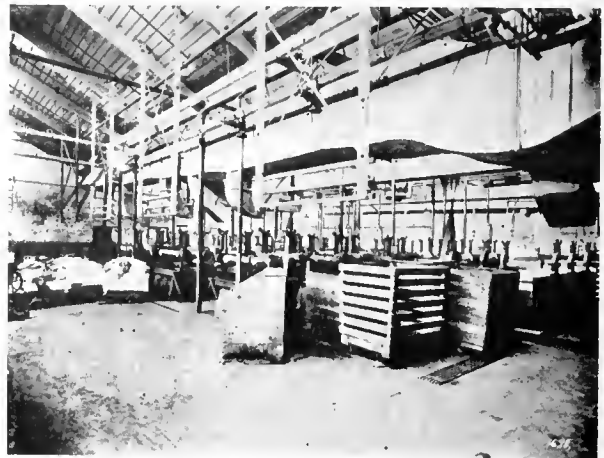

A DYE HOUSE INSTALLATION

The design of heating and ventilating systems for buildings devoted to this industry requires careful study. The large quantity of steam constantly present tends to produce excessive condensation on all cool surfaces. This being especially detrimental to wood and iron must be to a large measure counteracted by the system installed.

THE AMERICAN ARCHITECT

hour. As this must be brought in by 720,000 cubic feet of air, the problem now becomes to what temperature must the air be raised to absorb this amount of heat? This is given by

$$T = \frac{55 \times 1,516,400}{720,000} = 116 \text{ degrees}$$

which added to the initial temperature of zero gives a final temperature of $0 + 116 = 116$ degrees. Looking in Table III we find that a heater 20 pipes deep is required to give a final temperature equal to this. Also from Table IV it will be seen that a heater of this depth will have an efficiency of 1,500.

The total heat to be supplied is 1,516,400 thermal units. Hence $1,516,400 \div 1500 = 1011$ square feet of surface will be required.

AIR DISTRIBUTION AND RE-CIRCULATION

The method of distributing the warm air under different conditions is best described by illustrating a number of typical buildings.

In certain plants where the rooms are well filled with operatives, or where the processes carried on are such that maximum ventilation is required at all times, the heater should be designed for giving the full air supply in zero weather. In other plants, where the requirements are not so exacting, satisfactory results may be obtained by re-circulating the full volume of air within the building in zero weather and gradually increasing the outside supply as the temperature rises, until the full quantity is taken from outside when the temperature reaches 25 or 30 degrees. In other cases, where the cubic space is large per occupant, it may be entirely satisfactory to recirculate the entire air volume for all outside temperatures below 40 or 50 degrees and depend on natural leakage for the fresh supply. The latest theories of ventilation lay special stress upon air movement and temperature regulation, and these are easily brought about when a fan system is employed. The main heater may be supplied with any steam pressure desired, but is usually made to utilize the exhaust the same as in direct heating. Temperature regulation may be secured in different ways, the most common being to shut off a part of the sections or by-pass a portion of the air around the heater by means of a special damper provided for this purpose.

ANOTHER ARRANGEMENT

A good arrangement is a combination of these methods, using the steam valves for rough regulation and the by-pass for the finer changes which need to be made from hour to hour or at shorter periods during the day. In many cases the by-pass damper is operated automatically by a thermostat placed in the main room of the factory.

In buildings of several stories, or consisting of a

number of rooms or departments requiring different temperatures, or having different exposures, each room must be regulated independently. This is ordinarily done, within certain limits, by varying the quantity of warm air admitted to the room, rough regulation for the entire plant being brought about by changing the air temperature leaving the main heater, this being under the control of the engineer.

When conditions are such that the air supply must not be cut down below a certain minimum, then the temperature of the room must be regulated independently of the air supply. When the system is arranged for the re-circulation of air, return ducts should be provided with inlets from different parts of the room. Otherwise the rotation of air will be localized in the vicinity of the fan and the circulation in other parts will be weakened. However, in buildings of medium size, with the warm air well distributed, return air for re-heating may be drawn directly into the heater casing, or at least through a comparatively short duct without interfering seriously with the distribution.

It has been necessary to print Part III of Mr. Hubbard's article in two sections. Some of the figures referred to in this section will appear with the second section in the January 26 issue.

We, therefore, suggest to our readers that, after reading this first part of the discussion, they save these pages, and read the whole article again when the next issue appears on January 26.—Editor.

American Industrial Art

THE Fifth Exhibition of American Industrial Art will continue until January 30 at the Metropolitan Museum of Art. It is intended to be a demonstration of the practical or trade value of an art museum, a proof of the educational use made of museum objects for the advantage and improvement of current design in many industrial art branches. Objects and designs have been brought together which were made for the commercial market, but which, in a greater or less degree, owe their conception or method of execution to the study of museum originals or other resources in allied departments. An effort has been made to select examples in varied types of material, form, color, texture, and technique generally, in widely separated lines of production, yet all destined for the open market and all showing that museum study has been found worth while in terms of the selling product which results.

Manufacturers are urged to acquaint themselves with museum resources. Richard F. Bach, Associate in Industrial Arts, is ready at all times to assist manufacturers, designers, artisans, and craftsmen in objects of industrial art.

The Garage Fire Record*

Sprinklers Prove Ability to Extinguish Garage Fires

THE registration of motor vehicles in the United States has increased from about 48,000 in 1906 to 7,565,446 in 1919. The increase from 1915 to 1919 has been 5,200,000. The number of automobiles manufactured and placed in service is still increasing in geometrical ratio. In 1919 there was a total increase in registration of 23 per cent., and despite transportation difficulties the manufacturers' estimates for 1920 indicate the largest automobile production in the country's history.



FIG. 1. FIRE EXTINGUISHED BY ONE SPRINKLER HEAD, WHICH WAS STILL OPERATING WHEN THIS PICTURE WAS TAKEN

It is a self-evident fact that these automobiles are accommodated in garages; that garage construction has kept pace with the multiplication of the automobile. There are no satisfactory national statistics on garage construction, but automobiles are too valuable to leave in the open exposed to the weather, and it is reasonable to assume that garage facilities have increased in proportion to the automobiles. This mushroom growth of garages continues, unadvertised and unnoticed by the majority. Unlike housing construction, it has not been halted by increased prices or other difficulties. In fact, it is the largely held opinion that the automobile and its attendant extravagances are responsible at least in part for the present housing shortage. Such statistics as are available are not inconsistent with this contention. For example, in one American city for the first six months of 1920 building permits were issued as follows: Single houses, 1; apartment houses, 2; garages, 114.

*Reprinted in part from the October Quarterly of the National Fire Protection Association.

Fire experience and municipal legislation have been responsible for great improvements in the modern garage over the converted livery stable and carriage repair shops of ten and fifteen years ago, but there remain many features requiring further betterment. And, with the continuing era of garage construction, there will still be opportunity to incorporate the best features in new garages.

Gasoline is the inherent, fundamental hazard of the automobile and its storage and repair. Gasoline itself is not, properly speaking, a cause of fire, although it is frequently reported as such. However, it may be regarded as a contributory cause in the great majority of garage fires. For whatever the primary cause of fire, gasoline usually is responsible for its rapid spreading. The mitigating circumstance is the fact that the hazard of gasoline is now fairly well recognized, even if not fully realized. Large quantities are not ordinarily present inside the garage buildings except in proper containers (if automobile tanks are considered proper containers). The quantities present, although comparatively small, are, with the inadequate ventilation usually obtained, amply sufficient to occasion serious fires. And when a fire is one well under way, the gasoline tanks are destroyed, contributing their fuel. * * *

CONSTRUCTION FEATURES

Ventilation is perhaps the most important of all construction features. With adequate ventilation explosive gasoline vapors would not collect, and a large part of the fire hazard would be eliminated. For a discussion of garage ventilation see Charles E. Worthington's article, "The Common Sense of Garages," which appeared in the N. F. P. A. Quarterly last January.

Modern garage buildings are usually of concrete, and therefore fire-resistant. But there is a tendency toward very large areas. Horizontal areas are usually as large as possible and are in no way obstructed by partitions, while in the city garage occupying several floors there is seldom any attempt made to protect vertical openings. Although seldom used in garages, fire doors can give, and have given,

excellent accounts of themselves in the journal of fire experience.

AUTOMATIC SPRINKLERS

Claims have sometimes been made that the garage hazard is too severe for ordinary automatic sprinkler protection, and that application of water is likely to spread the fire by floating burning gasoline. Records show no basis for such opinion. In the files of the National Fire Protection Association there are reports of 134 fires occurring in sprinklered garages. The accompanying table shows that of the 134 there were only four failures, making a total of 130 fires, or 97.1 per cent., where the operation of the sprinklers were satisfactory. This compares favorably with a general average of 95.7 per cent. for all class of occupancy. Of the four failures, two were due to water shut off sprinklers and two due to obstructions to distribution. A review of all the garage fire reports in the files of the National Fire Protection Association has failed to disclose any instance in which burning gasoline was spread by water from sprinklers.

The accompanying photographs (Figs. 1 and 2) contrast the results of fire in sprinklered and unsprinklered garages. In the first case (Fig. 1), one sprinkler operated and extinguished and confined the fire to the car in which it started. Mr. H. L. Miner reports:

Fire occurred in a one-story frame garage 50 by 100 feet in area, which contained twelve automobiles. Garage was locked up Saturday afternoon. Monday morning, when next visited, it was found that fire had occurred in one of the automobiles, cause unknown, possibly due to defective electrical system, or possibly from a smouldering fire due to smoking in the upholstery of the car. One automatic sprinkler to all appearances opened promptly and, although top of car was raised, thereby introducing considerable obstruction to distribution, the automatic sprinkler entirely extinguished the fire. Five feet from the automobile was a tank of compressed acetylene gas, also an oxygen tank. Photographs shows position of car in garage and oxygen and acetylene tanks referred to above. The automatic sprinkler was still operating when this photograph was taken. This is really a remarkable demonstration showing the effectiveness of automatic sprinkler protection, even though the sprinklers are working under a serious handicap.

Figure 2 shows what recently happened in an unsprinklered garage in Yakima, Washington. Note that the building had brick walls—

incombustible outside walls, to the ignorant, give the all too frequent impression that a building is "fire-proof." Mr. John Perry reports that thirty machines were destroyed, with an estimated loss on building and contents of \$88,000, and considerable damage to adjoining buildings not included in this figure.

TABLE OF LOSSES ON GARAGE FIRES, NATIONAL FIRE PROTECTION ASSOCIATION RECORDS.

Sprinklered:	No. of Fires.
*Small	134
Large	—
	134
Unsprinklered:	
Small	250
Large	129
	379
Total	513

*Small loss is under \$5,000.

The Table of Losses, showing a fairly large proportion of large losses in unsprinklered garage fires, while in sprinklered buildings, of the 134 fires on record there are no losses over \$5,000, is another rather convincing argument for the sprinkler.



FIG. 2. A RECENT UNSPRINKLERED GARAGE FIRE IN YAKIMA, WASHINGTON

Contrast this fire, where thirty machines were destroyed, with that shown in Fig. 1, where one sprinkler head confined the fire to the car where it originated.

Relative Heat Conductivities of Some Building Materials

Results That Represent What May Be Expected Under Actual Service Conditions

THE Verona Chemical Company of North Newark, N. J., has been conducting an investigation to determine by the air box method the relative heat conductivities of building materials. The tests of the different materials were conducted under identical conditions as nearly as was possible. A number of cube-shaped boxes were constructed of the different materials of practically the same dimensions which were approximately 8" x 8" x 8" inside. The thickness of the walls was about one inch. An electric lamp was used as a heating element inside these boxes. The electric current was regulated by a rheostat and measured by accurate voltmeter and ammeter.

MEASUREMENTS OF TEMPERATURES

The temperature inside was measured by two thermometers and outside by three thermometers and these thermometers were placed in the same relative position on each testing box.

The testing apparatus was set up in the basement of the laboratory, where the room temperature was fairly constant. No readings were taken during the first twenty-four hours in order to allow time for all conditions to reach an equilibrium. After this, readings were taken about every two hours.

The conductivities "K" as shown in the accompanying table in B. T. U. were calculated from the formula:

$$K = \frac{3.415 \times B \times W}{12 \times A \times (T-t)}$$

where "B" is the thickness of the walls in inches;

"A" is area in sq. ft., "W" is the watts from the voltmeter and ammeter readings; and "T-t" is the difference between the inside and outside temperatures as indicated by the thermometers. Area "A" was considered to be the mean between the inside area and the outside area of the box. The thermal conductivity so measured represents the quantity of heat expressed in B. T. U., that flows through one square foot unit area of plates, through a unit thickness of one foot having a unit difference of 1 deg. Fahrenheit between its faces.

DISCUSSION OF RESULTS

The results thus obtained cannot be accurately compared with results of similar tests made under different conditions, because the conductivity "K" found in this way is not the heat transmitted only through the tested material of the thickness "B." It is the heat which passes also through the layer of air from the inside thermometer bulb to the wall, hence through the wall, and thence from the outside of the wall to the outside thermometer bulb.

The results will be different from results of tests where air contact has been excluded. They will also be different from tests, where fans or other devices have been used to keep the air in motion, thereby diminishing the resistance to the heat entering into the wall of the material to be tested. Inasmuch as the figures are arrived at under the conditions under which the materials are used ordinarily in building construction, they will give a good idea of the relative values of heat conductivity of the different materials tested.

RESULTS OF THERMAL CONDUCTIVITY TESTS.

Material.	Box inside dimensions, ins.	Walls, mean thickness, ins.	Mean area, sq. ft.	Volume box, cu. ins.	Weight box, lbs.	Spec. grav. ity.	Weight per cu. ft., lbs.	Electric current consumed, watts.	Mean inside temper. Fahr.	Mean outside temper. Fahr.	Temper. diff., Fahr.	Heat conductivity.
Concrete, 1 cement: 2 sand.....	8 $\frac{1}{2}$ x8 $\frac{3}{16}$	1 $\frac{3}{16}$	3.612	618	45.63	2.01	128	49.0	107.2	81.2	26.0	0.1760
Gypsum board	8x1 $\frac{1}{16}$ 8 $\frac{1}{4}$ x8 $\frac{1}{4}$	1 $\frac{1}{8}$	3.619	588	21.25	1.00	62.5	31.6	115.7	82.7	33.0	0.0846
Porete reinforced with exp. metal....	8 $\frac{1}{4}$ x8 $\frac{1}{4}$ x8 $\frac{1}{8}$	1 $\frac{1}{16}$	3.564	546	19.40	0.98	61	44.5	131.5	88.1	43.4	0.0786
Yellow pine, North Carolina.....	8 $\frac{1}{4}$ x8 $\frac{1}{4}$ x8 $\frac{1}{16}$	1 $\frac{3}{32}$	3.541	558	12.88	0.64	40	50.5	145.5	83.7	61.8	0.0719
Air cell, asbestos board.....	8 $\frac{1}{16}$ x8 $\frac{3}{16}$ x8 $\frac{1}{8}$	1 $\frac{1}{8}$	3.530	572	4.40	0.21	13	29.7	156.0	78.0	78.0	0.0335
Cork-board	8x8x8	1 $\frac{1}{8}$	3.470	566	3.83	0.187	11.7	6.82	94.9	72.2	22.7	0.0277

Current News

Happenings and Comments in the Field of Architecture and the Allied Arts

Better Distribution of Aliens Aim of New Bureau

Through the establishment of a new bureau at Ellis Island, New York, in charge of economic and linguistic experts, better distribution of aliens, particularly with a view to avoidance of their congestion in large centers of population, is to be sought. The census this year reveals a tendency of the general population to flock to cities, and the new bureau, through its co-operation with state authorities, hopes to gain a much better distribution of aliens through rural communities.

The new bureau is to be known as the Division of Immigration Distribution and its chief, according to Immigration Commissioner F. A. Wallis, will probably be P. A. Donohue, an economic expert from the U. S. Department of Labor. Mr. Donohue has been a member of several boards of inquiry at Ellis Island, and it is believed he will be well fitted for his new position through his war work for the Federal Employment Bureau.

Prehistoric Village Found

Discovery of the ruins of a prehistoric village and cemetery, in which were many relics of great value, in the Navajo country in New Mexico, has been announced by the American Museum of Natural History. The discovery was made by an exploration party headed by Earl H. Morris.

Fragments of polished pottery, glistening in the sun, led the party "by mere chance" to the new discovery. Mr. Morris wrote to headquarters here. Hundreds of pottery vessels of artistic design and scores of ancient tombs, which revealed many interesting habits of living, were unearthed, he said.

"There had been more than twenty dwellings in the village," he said, "varying in size from four to as many as fifty rooms."

In Prague

In Czechoslovakia, the system of locking up a house is very peculiar. There are usually two very inferior locks on an outside door, which is further fastened on the inside with a small chain. The chain is considered necessary, because anyone who has a dozen or so keys could go about and unlock most of the doors in the street. The keys are always large

and unwieldy things, frequently 5 or 6 inches long.

There would be some local conservatism to combat in attempting to introduce a really good spring lock, but there is no doubt that they are much needed. Furthermore, there will soon be a great deal of building in Czechoslovakia, especially in and about Prague. The needs of the rapidly growing city have not been satisfied by the existing office and dwelling accommodations, and building has been at a standstill for several years. It is now beginning to revive.

Pennsylvania Academy Annual Exhibition Announced

The 116th annual exhibition of the Pennsylvania Academy of Fine Arts will open to the public on Sunday, Feb. 6, 1921. It will close on March 27. Press view and varnishing day will be Saturday, Feb. 5. The reception and private view will be given in the evening of the same date. The Artists' Evening will be held on Feb. 12.

The usual long list of prizes, medals, etc., is announced. The honors include the Academy gold medal of honor, the Temple fund and gold medal, the Edward T. Stotesbury prize of \$1,000, the Walter Lippincott prize of \$300, the Philadelphia prize of \$250, the Mary Smith prize of \$100, the Jennie Sesnan gold medal endowed by Elizabeth W. Roberts, the Carol H. Beck gold medal, the Lambert fund and the George D. Widener memorial medal.

The members of the jury are: Robert Vonnoh, chairman; Cecilia Beaux, Frank W. Benson, Hugh H. Breckenridge, Adelaide Cole Chase, William J. Glackens, William M. Paxton, William Ritschel, Robert Spencer, Helen M. Turner, Carroll S. Tyson, Jr., A. Stirling Calder, Charles Grafly and Albert Laessle.

Famous Workhouse Closes

St. George's workhouse, just south of London bridge, where Oliver Twist had the audacity to ask for a second helping of thin gruel, has been closed by the poor law authorities and the inmates have been transferred elsewhere. The gruel, of which Dickens' child hero and his fellow sufferers partook, was made in a copper cauldron, which is to be presented to the Southmark Borough Council's museum.

Gobelin Works Admit Women

For the first time since the famous Gobelin tapestry works were established in France, back in 1664, women are now being taught to make tapestries.

Danes Erect Obelisk

An obelisk of granite 70 feet high is to be erected in Denmark as a memorial to the many thousands of American and Allied soldiers of Danish descent who died in the World War. It has been estimated that about 30,000 men of Danish blood fought in the American armies in France and that about 20,000 Danes fought in the Canadian, Australian British and French armies.

The proposed obelisk will rest on a base twelve feet high, on one side of which will be two women's figures, one elderly, the other young, both with slightly bowed heads, expressing the sorrow of the motherland and her emigrant daughter for those who died in war. On another side will be an American eagle with the Star Spangled Banner, and in addition there will be bas-reliefs of typical war scenes from the American and Allied fronts.

Bridge Resists Floods for Ages

In Foochow, China, the city of the white pagoda, is the "Bridge of Ten Thousand Ages." Endless time and labor must have been expended on the bridge, which is one thousand years old, states a report in the *Chicago News*. It is all of granite, each stone roughly carved to fit its neighbor without a bit of mortar and to resist the river in flood and ebb. The massive piers, ten feet thick, piles of rough hewed stone, are like inverted pyramids, buttressed on the river sides and on the inner sides, each layer of rock extending a foot beyond the layer below. Twenty feet is the widest span between any pair of the seventy-five piers and nothing wider than a sampan or raft passes on the turgid Min river.

Immense slabs of granite are the spans between the piers. Countless silken slippers, bare feet of chair bearers and straw sandals of sweating coolies have worn the surface smooth, while grass and wild shrubbery grow in the crevices of the piers and around the carved lions and dragons on the posts of the ponderous stone handrail. The roadway is no wider than an automobile.

But this picturesque bridge is to be replaced by a grim structure of steel—for automobiles, carriages and trucks and broad roads from the country have come to Foochow. The shifting bed of the muddy Min is to be dredged and ocean steamers will come to the city, instead of anchoring fourteen miles below.

Reconstruction in Belgium

Of all the warring countries in Europe none have returned to their pre-war activities in a measure comparable to Belgium, according to recent Commerce Reports. When the armistice was signed the country found itself with a third of its factories ruined. In transportation essentials, 2,000 kilometers (1,250 miles) of railroads, 1,800 bridges, and 600 kilometers of canals had been destroyed, 60,000 railroad cars and 2,500 locomotives taken by the Germans, and the telegraph and telephone systems ruined.

Progress made in the past 18 months toward reconstruction is so phenomenal that within the next six months all pre-war industries excepting steel plants will have attained, where they do not already exceed, the production of pre-war years.

Practically all railway trains in the country are running on pre-war schedules, the roadbeds and bridges having been for the most part repaired or reconstructed.

Agricultural activity commenced immediately after armistice was signed, with the result that crops produced in 1919 fully equalled those of 1913. As an evidence of the intensity with which Belgians applied themselves to work, it is interesting to note that, on the termination of war, there were upward of 800,000 persons receiving chomage (unemployment wage), while at present the number has been reduced to less than 200,000.

Much of this remarkable progress is due to the activity of the Recuperation Committee which has succeeded in recovering most of the machinery taken away by the Germans.

Reconstruction has been but little handicapped by the few strikes occurring, and there is little or no spirit of Bolshevism among the inhabitants.

Personals

McCluer & Griffith, architects, formerly Dexter & McCluer, are now operating at 401 Canby Building, Dayton, O. Mr. Dexter has retired from the firm.

A. H. Ebeling, architect, has moved his office from 1106 West Fifteenth street, Davenport, Ia., to 818-9 Kahl Building, that city.

The K. L. Hullsick Company, architecture and engineering, has opened an office at 400 Flatiron Building, Norfolk, Va.

A. E. Norman, architect, formerly located at 1526 Devon avenue, Chicago, Ill., is now practicing at 1531 Devon avenue, that city.

Weekly Review of the Construction Field

With Reports of Special Correspondents in Regional Centers

NOTHING is worse than the hypocritical optimist.

The fellow who shouts optimism from the house-tops and tells the truth in the secret places is the most dangerous factor in any industrial community. If a market for a given commodity is weak, and continues to be weak, it does no good, and much harm, to insist that "conditions are improving" and "are better." No harm comes from telling an industrial truth. The leaders in industry and finance are leaders because of their foresight. That is their stock in trade. Upon that their present and future business reputations rest and always will rest. They can no more risk injury to it than an architect can risk injury to his reputation by insisting that an unsafe building is safe.

It was for precisely that reason that this journal published the opinions of prominent industrial and financial leaders regarding the future of both industry and finance. When men such as Judge Gary, Daniel Guggenheim, and Francis H. Sisson speak of the near future with confidence, one may rest assured that there is little to worry about the fundamental

soundness of that future. It is petty and of no use to point to existing conditions as arguments against the optimistic opinions of these men. Their present importance and value in the industrial scheme was achieved by the keenest sort of foresight. It is as keen today as it ever was. Perhaps even keener.

Upon what do these men base their optimism?

Such a question may seem a bit incongruous after granting them a sort of foresight not possessed by the average man. There is no way of knowing upon what they have based their opinions. But there are salient facts in the industrial situation—the price problem, for example—which could be taken as a basis for industrial optimism by any man possessed of common sense and that sort of reasoning power which sees more than the printed word or price.

The table shown below represents wholesale commodity prices for 17 commodities which have been chosen for their representative character and their relation to fundamental business conditions. The figures were compiled by the National Bank of Commerce in New York, and are but a small part of a chart presented by that bank in its January house

Commodity.	1920												1914 Jan.
	Jan.	Feb.	Mar.	Apr.	May.	June	July	Aug.	Sept.	Oct.	Nov.	Dec.	
CATTLE —													
Fair to choice native steers, Chicago ¹	14.05	13.35	13.30	13.90	12.30	15.90	15.50	14.85	15.50	14.70	11.25	9.50	8.60
COAL —													
Anthracite, No. 1 buckwheat, f. o. b. lower ports, N. Y. ²	5.25	5.50	6.00	5.75	5.75	6.30	6.50	6.50	8.00	8.00	8.00	8.00	2.25
Anthracite, stove, f. o. b. mine ²	6.60	6.60	6.60	6.60	7.70	7.50	7.65	7.75	8.00	8.00	8.00	8.00	4.00
Bituminous, run of mine, f. o. b. mine Fairmont, W. Va. ²	2.80	2.80	2.80	4.25	5.50	9.50	12.00	12.00	10.75	10.75	5.50	4.00	.85
Pittsburgh District ²	2.35	2.35	2.35	4.25	5.25	8.50	10.00	11.00	9.00	9.00	5.00	3.75	1.30
COPPER —Electrolytic, early delivery, New York ³	19.25	18.50	18.00	18.75	18.37½	17.87	18.75	18.62½	18.12½	16.25	14.50	13.75	14.12½
CORN —No. 2 mixed, Chicago ⁴	1.49	1.43	1.46	1.68	2.15	1.82	1.52½	1.60	1.37½	.95	.83½	.72	.62½
COTTON —													
Middling, spot, New Orleans ⁵	40.25	39.25	41.00	41.50	40.25	40.75	39.00	34.50	28.50	20.25	18.25	14.75	12.88
HIDES —													
Green salted packers, No. 1 heavy native steers, Chicago ⁶	40	40	37	35	36	35	30	28	28	25	23	20	17¼
Calfskins, No. 1, Chicago city ⁶	80	70	50	55	50	35	35	27½	28	18	18	15	21
HOGS —Good merchantable—pigs & rough stock excluded, Chicago ⁴	14.70	14.80	14.95	15.10	14.50	14.80	14.80	15.05	16.20	14.90	12.60	9.10	8.25
IRON and STEEL —													
Pig iron, basic, Valley furnace ²	37.00	43.00	41.00	42.00	43.00	43.50	46.00	48.50	48.50	46.00	38.50	33.00	12.50
Steel billets, open hearth, Pittsburgh ²	45.00	58.00	60.00	65.00	65.00	65.00	65.00	60.00	60.00	55.00	50.00	5.00	20.00
LEAD —Pig, early delivery, N. Y. ³	8.75	9.00	9.37½	9.00	8.50	8.65	8.60	9.25	8.00	7.60	6.60	4.75	4.10
PETROLEUM —Crude, at well													
Pennsylvania ⁵	5.00	5.50	6.10	6.10	6.10	6.10	6.10	6.10	6.10	6.10	6.10	6.10	2.50
Kansas-Oklahoma ⁵	3.00	3.00	3.50	3.50	3.50	3.50	3.50	3.50	3.50	3.50	3.50	3.50	1.03
RUBBER —													
Plantation, first latex crepe, N. Y. ⁷	.53½	.48	.48½	.45	.38	.38	.33	.31½	.25	.24	.20	.17½	.56
Para, upriver fine, New York ⁷	.49	.45½	.42	.42	.39½	.37½	.34¾	.32½	.27	.24½	.22	.19¼	.73
SILK —Shinshu No. 1, New York ⁸	16.25	14.80	13.65	11.70	8.15	6.50	6.50	5.40	6.25	6.40	6.30	6.20	3.80
SPELTER —Prime western, early delivery, St. Louis ⁹	9.10	8.70	8.60	8.45	7.75	7.50	7.85½	8.00	7.75	7.30	6.37½	5.75	5.10
SUGAR —96° centrifugal, N. Y. ⁸	13.04	12.04	11.54	18.56	21.57	19.56	18.31	13.04	10.78	8.03	6.51	4.63	3.29
SULPHURIC ACID —66° Be., bulk, sellers' tank cars, East'n points ⁷	20.00	20.00	20.00	20.00	21.00	22.00	22.00	22.00	22.00	22.00	21.00	20.00
WHEAT —													
No. 1 northern spring, Chicago ⁴	3.10	2.55	2.60	2.95	3.30	2.95	2.95	2.66	2.46	2.22½	1.88¾	1.61¼	.91½
No. 2 red winter, Chicago ⁴	2.65	2.40	2.47	2.75	3.06	2.95	2.85	2.56	2.49	2.39	2.11¼	2.00	.90½
WOOL —Clean basis, Boston													
Ohio fine detainee ⁶	2.30	2.35	2.35	2.35	2.25	1.85	1.74	1.65	1.50	1.30	1.25	1.12	.56
Ohio ¼ blood ⁶	1.07	1.05	1.05	1.10	1.00	.80	.79	.75	.70	.60	.57	.45	.39

¹Dollars per 100 lbs. ²Dollars per gross ton. ³Cents per lb. ⁴Dollars per bu. ⁵Dollars per bbl. ⁶Dollars per lb. ⁷Dollars per net ton.

THE AMERICAN ARCHITECT

organ. Any architect would profit considerably in a careful study of that chart. There is a great business sermon in it.

The writer would respectfully direct attention to a careful comparison of the prices for the commodities indicated in January, 1914, and December, 1920.

Also to a careful comparison of the prices from January, 1920, to the end of the year.

And next week there will be considerably more to say about them. It would be a good idea to keep this issue at hand or to clip this chart. You will have occasion to refer to it frequently. It will be taken as a basis for a series of price discussions, the first of which, "The Architect's Relation to Price Declines," will appear in this department in the issue of January 26.

(Special Correspondence to THE AMERICAN ARCHITECT)

SEATTLE.—Optimism, effervescent or otherwise, is not responsible for the brighter feeling in Pacific Coast business circles regarding the sudden change in mental posture toward reconstruction of buying for new commitments early in 1921. Lumber is believed to be at bottom from the fact that wholesalers have begun to buy. Jobbers of building hardware are preparing to buy on the new price list reached when the independents shrunk away the premiums of war-time and touched the Steel Corporation levels, there is accumulating evidence of the return of confidence of buyers to building materials, and the farthest possible date at which resumption is now placed by many of the keenest minds in this territory is March 1, with proportionate symptoms of recovery during January.

There is no doubt whatever that during early December not a jobber in a hundred would have claimed, excepting for public consumption, that the coast conditions could change before midsummer. Revision of figures with the conclusion of stock-taking, increased inquiries with architects, larger activity of public building construction and homes, conviction that steel products can go no lower until after the 1921 placements have been cleared are factors that have built up the new atmosphere overnight. This feeling is increasing hourly.

Concededly among jobbers, with the facts at hand rather than sentiment or personal opinion, the New Year will be a buyers' and not an order-book year, and the educational trend and activity of selling organizations in building lines is being shaped to that end. Men in the field are being warned that now, as at no time since 1914, they will be expected to move rapidly and to meet keen competition for business, even to searching out the long-neglected and insular buyers. The old-time zest of getting orders has started.

Jobbers of building hardware, nails, sheets and

pipe are today buying only light in order to ride out the earlier pauses during January, but as for accepting the Steel Corporation basis as fundamental and not subject to further change during this year, the thing is as good as done, and the jobbing trade feels its position secure when treating problems of the new building season.

The factor that has held off buying during the past 30 days, when delivery from the mills has come nearly to normal, is the dumping on the market by shipyards of pipe, bar, cleats, rivets, bolts and pipe, larger sizes predominating. These huge stocks, accumulated during the speed-up war period, are being offered under the market as the shipyards that bought them are being dismantled. The jobbing trade does not feel justified in buying even on the sound steel market when all these stocks are lying round loose at the mercy of any chance speculator.

There is on the coast today no shortage of building essentials. Cement, probably the last to show normal conditions, is being supplied in sufficient quantities to meet the needs of the hour. None care to accumulate stocks for the next 30 days.

Fully 50 per cent. of the fir lumber mills that closed for the holidays, supposedly for an indefinite time, will be in operation by January 15. Many reopened before New Year's day. A decline of a dollar in common dimension, or to \$13.50 to the trade this week had been discounted in advance, and this, it is now felt certain, will be the last fall in prices for some time.

Wholesalers believe the time is ripe for buying, and will start doing so during January. Should a drop of another dollar occur, as a minority now predicts, wholesale buyers say it will only be necessary to hold their purchases past the next soft spot in order to realize a profit. Their conviction that recovery in the lumber market is now due is their foundation for proposed buying activity.

(Special Correspondence to THE AMERICAN ARCHITECT)

CHICAGO, Jan. 17.—It is becoming increasingly apparent that the only obstacle in the path of a great building revival in the Chicago district is the matter of price on lumber, labor and materials. And it is not so much a question of the actual cost as of the uncertainty now attending the whole price situation. Those who contemplate building, whether they be individuals or corporations, are apparently hesitating because they have no way of judging the stability of prices at this time and do not desire to make a building investment that will be periled by early and more substantial declines in the cost of everything that goes into the finished building.

If this fog of uncertainty and distrust can be lifted, there is no reason—in the view of the best posted men in the building industry in Chicago—why the

THE AMERICAN ARCHITECT

building program, so long talked of, cannot be successfully instituted at once.

Cost alone is holding back the bandwagon. Plans have been made; the need is very great, the money is available—only the indecision of the market in construction materials remains the unknown factor in the building equation.

Frankly, there is a feeling on the part of those who are about to invest in new construction work that prices have not yet dropped sufficiently and that a little waiting will bring the market to much lower levels.

Lumber, labor and the minor materials have been accused of attempting to take a small loss with such loud acclaim and such a blare of trumpets that the public will immediately assume that the rock bottom has been reached and that there is nothing more to expect in the way of price reduction.

The public, however, declines to take this point of view, and the psychological effect is to produce a buyer's strike which is just as keenly felt in the building trades as in shoes or ships or sealing wax, or any other of the lines that have suddenly slowed up as far as consumer demand is concerned.

The foregoing represents the darker side of the situation, but let a brighter point of view be unfolded.

The interests whose prosperity is gauged by the amount of building have seen the light and are now bringing themselves together with a view to settling the market and of laying the ghost of price uncertainty, once and for all.

The first step in this direction was taken in the Chicago territory by Edward Hines, a prominent lumber manufacturer, whose business sagacity and foresight have made him a leading figure in the lumber industry. Sensing this watchful waiting attitude on the part of the building public, he called a conference of lumber manufacturers from all parts of the country. They met in Chicago, January 5-6, and made a hasty summary of the situation, deciding in very short order that the lumber industry alone cannot swing the pendulum of price back to a normal stability. To the end that the mists of indecision may be cleared away, however, the lumber interests have called another conference—this to be held in Chicago January 21-22, at which all factors in the building materials field will be represented. Here all the manufacturers whose products go into the building industry will sit down in a heart-to-heart fashion in order to bring about as complete a clarification of price as is now possible.

At this conference lumber manufacturers, retail and wholesale lumbermen, manufacturers of paint, cement, stone, granite, building metals, shingles, laths, lime, gypsum, glass, brick, sand and gravel—every line in the building list will be present and the whole building impasse will be thoroughly considered,

with price of materials as the crux of the whole conference.

That the meeting is going to be an Armageddon of disputatious views is thoroughly expected. Each trade is going to point out the utter impossibility of a further decline in its product, but out of the whole mass of conflicting opinion seems sure to come a concord of action that may give the desired result of stability of prices.

Labor is not going to share very prominently in the conference, but the element of labor is bound to come in for a great deal of discussion, and the general feeling is that the industry is going to be much nearer a normal basis of opinion after the meeting than is now the case.

Not content with engineering a general conference on the building situation, the lumber manufacturers, acting in concert with the National Lumber Manufacturers' Association, have recently sent a delegation of their leaders to Marion, where a conference was granted by President-elect Harding. The committee was given a two hours' audience, during which the side of the lumber industry in the housing shortage and the willingness of that industry to co-operate in a return to normalcy were presented to Senator Harding.

No program of tangible facts was presented at the Marion conference, and President-elect Harding did not express his views upon the pros and cons of the building situation, but he asked a great many questions indicating his very great interest and his anxiety to be thoroughly posted on the technical points of the discussion.

Another tangible result of the conference of the lumber interests recently held in Chicago is the announcement that a fund is to be raised within the industry to advertise lumber and its uses and to build up in the public mind the feeling of confidence that the industry is not attempting to impose unreasonable prices on lumber.

Another meeting of unusual interest is that of the Associated Building Contractors of Illinois, held in Chicago during the second week in January.

Although the week has been marked by meetings, conferences and discussions of lower prices for lumber and materials, the prices remain virtually unchanged.

Materials linger at old figures, with business very quiet, but with the factors in the trade quite hopeful as to the outcome.

Some reductions are in contemplation, it is said. Mixed paints are expected to show an early decline, following a cent a pound reduction in all leads, announced this week by leading manufacturers. Current lumber and materials quotations in the Chicago market are:

Yellow Pine:—B. & B. 1 in., \$95 to \$130; 13-16,

THE AMERICAN ARCHITECT

3¼ flat flooring, \$85 to \$90; 2 by 4, 10 to 16 feet, No. 1 long leaf, \$51; 2 x 6, \$48 to \$49; 2 x 8, \$49 to \$50; 2 by 10, \$52 to \$54; 2 by 12, \$54 and \$56.

Northern Hardwoods, carload lots, Chicago:

Birch, four ¼ No. 1 and 2, \$155; select, \$130 to \$138; No. 1 common, \$95 to \$100; No. 2 common, \$60 to \$65; No. 3, \$35 to \$40.

Hard Maple, four ¼ No. 1-2, \$135 to \$140; select, \$115 to \$120; No. 1 common, \$95 to \$100; No. 2, \$60 to \$65; No. 3, \$32 to \$50.

Red gum four ¼ No. 1 and 2, \$148 to \$152; No. 1 common, \$88 to \$92; No. 2, \$43 to \$47.

Birch, four ¼ No. 1 and 2, \$155 to \$160; select, \$130 to \$139; No. 1 common, \$95 to \$100; No. 2, \$60 to \$65; No. 3, \$35 to \$40.

Douglas fir, 12 by 12, No. 1 up to 32 feet, \$65 to \$75; 14 by 14, \$68 to \$75; 16 by 16, \$70 to \$75; 18 by 18, \$75 to \$80.

Cement:—Universal, \$3; Lehigh, \$3.00; Portland, \$3.00.

Bulk lime, \$1.70 to \$1.90; face brick, octagons, \$68 to \$75; fire brick, \$32 to \$40; 12 in. .24 to .27, 18 in. .46 to .54.

Crushed stone gravel \$3.40 to \$4; lake and bank sand-torpedo, \$3.40 to \$4.

Present important building operations in Chicago:

Federal Reserve Bank Building; excavation and preliminary foundation work well along; Royal Insurance Building; three theatre buildings in the Loop; Chicago Board of Education Building; Government Parcel Post Station; and the Fair's nineteen story building on Monroe Street.

The last three represent an outlay of nearly \$5,000,000.

(Special Correspondence to THE AMERICAN ARCHITECT)

BOSTON, Jan. 17.—If one were asked to name the outstanding features of the business situation in New England today he would be obliged to mention all those facts in our industrial life which come under the head of business readjustment. There is the slowing up in industrial and commercial activity as reflected in reduced railroad earnings, steadily decreasing bank clearings and increasing unemployment. Many plants in such centers as Bridgeport, Waterbury, Providence, Fall River and Holyoke are

carrying a pay roll of one-third to one-half the amounts of four months ago. In the early months of 1920 clearings were running 25 to 30 per cent. ahead of the same months of last year. Recently they have in turn revealed a falling off of 10 to 14 per cent. compared with a year ago.

A 22½ per cent. cut in textile wages in New England was announced this week. In the steel trade, which so far has not cut wages, reduction is in the making.

The so-called consumer's strike will undoubtedly be called off as soon as there is any evidence that commodity prices have again reached a more stable basis. There does not seem to be as much quarrel today with the level of prices as there is in regard to the uncertainty as to whether the decline in commodity prices is over. For instance; no one will say that the fall in copper prices from 36 cents in the war period to 13½ cents has not been sufficiently drastic. But no one wishes to do much buying as long as the trend of prices is downward and not upward.

The Harvard University committee on economic research says: "Evidence of approaching business revival are not yet apparent in the news of the day, nor do we expect to see any very soon. There are considerations, however, which support the forecast drawn from our index chart that a revival of business will begin next spring, one being the fact that a number of raw materials, such as cotton, wool and leather, are selling much below recent costs of production and probably below costs that will rule next year, even with considerably reduced wages; another being the fact that the physical production, both mining and manufacturing, was less in 1919 and 1920 than in 1916, 1917 or 1918.

"Both of these considerations support the forecast that there will be a recovery in some prices at no distant date."

Statistics of building and engineering operations show that contracts awarded in New England from Jan. 1 to Dec. 15, 1920, amounted to \$297,733,962, as compared with \$235,356,000 in 1919; \$146,703,000 in 1918; \$195,443,000 in 1917; \$201,259,000 in 1916; \$171,820,000 in 1915, and \$159,280,000 in 1914 for a corresponding period.

54

fruits piece 8253



A FRENCH ROMANESQUE DOORWAY

THE AMERICAN ARCHITECT

VOL. CXIX

WEDNESDAY, JANUARY 26, 1921

NUMBER 2353

A Side Trip in Building

By THOMAS CRANE YOUNG

IN view of the fact that economic conditions have for the present combined to block all manner of construction, any proposed addition to the list of building material which may become generally available should receive thoughtful consideration. No known material is more equably distributed by nature over the surface of the globe than common earth, but few people now believe that in its crude state it can be made of practicable use for building purposes. Modern science has ignored the subject and the modern house builder has made no use of it

ry. Usually "adobe" walls are covered by a protective coat of plaster, although frequently they may be seen standing and useful without covering of any kind.

About one year ago an article appeared in an English illustrated journal called "*The Sphere*," which contained a description of "Pise' de Terre" masonry and claimed that substantial walls could be built by simply ramming nearly dry earth between two forms made of boards. These forms were described as of standard size, about ten feet long and three feet wide, and when tamped full, the forms could then be moved along horizontally and another section of wall laid in the same manner. Other courses could be laid by placing the same form on top of that part of the wall already built, and the process continued.

Since the publication of an article on earth walls



First Course—Shows form in place and filled with tamped earth
EARTH HOUSE, ST. LOUIS, MO.
THOMAS CRANE YOUNG, ARCHITECT

whatever, perhaps because manufactured products have been easy to get and cheap. Earth building is a forgotten art, yet history tells of its use, extending far back into the early centuries of civilization. In our day, war has forced back again into modern life many of the conditions and cruder customs usual only in a more primitive social state, and so perhaps a revival of this ancient practice may prove of use in solving some of our new and pressing housing problems.

Our country contains (mostly in the western states) many picturesque examples of earth building, or "adobe," made from puddled clay and straw, moulded into blocks and dried in the sun; these blocks are then laid in the wall like ordinary mason-



Shows completed walls ready for roof and finishing coat of plaster
EARTH HOUSE, ST. LOUIS, MO.
THOMAS CRANE YOUNG, ARCHITECT

in the *Literary Digest* some months ago, very many letters have been received expressing interest in the subject and for the most part earnestly requesting further information. One writer from Foochow, China, is, however, entirely skeptical as to the value of earth for building. He states that "mud" hovels are common in many parts of China, but they are uniformly insanitary and insecure when subject to heavy rains or floods. In this he is no doubt quite

correct, but our material is not "mud," and it must be remembered that similar conditions exist frequently when more expensive materials are used. Another, calling himself an "agricultural missionary," writing from Portuguese South Africa, says that if a practicable way of building with earth could be found, it would solve one of their most serious problems. Similar letters have come from Canada, Mexico and

used in testing cement. These specimens developed a tensile strength of from 80 lbs. to 125 lbs. per sq. inch after six days' seasoning in the form. A test for compression developed a strength of 125 lbs. per square inch. Later on, a small "cube" of earth used in the little building illustrated, failed under compression at 473 lbs. per square inch after forty-two hours' seasoning.

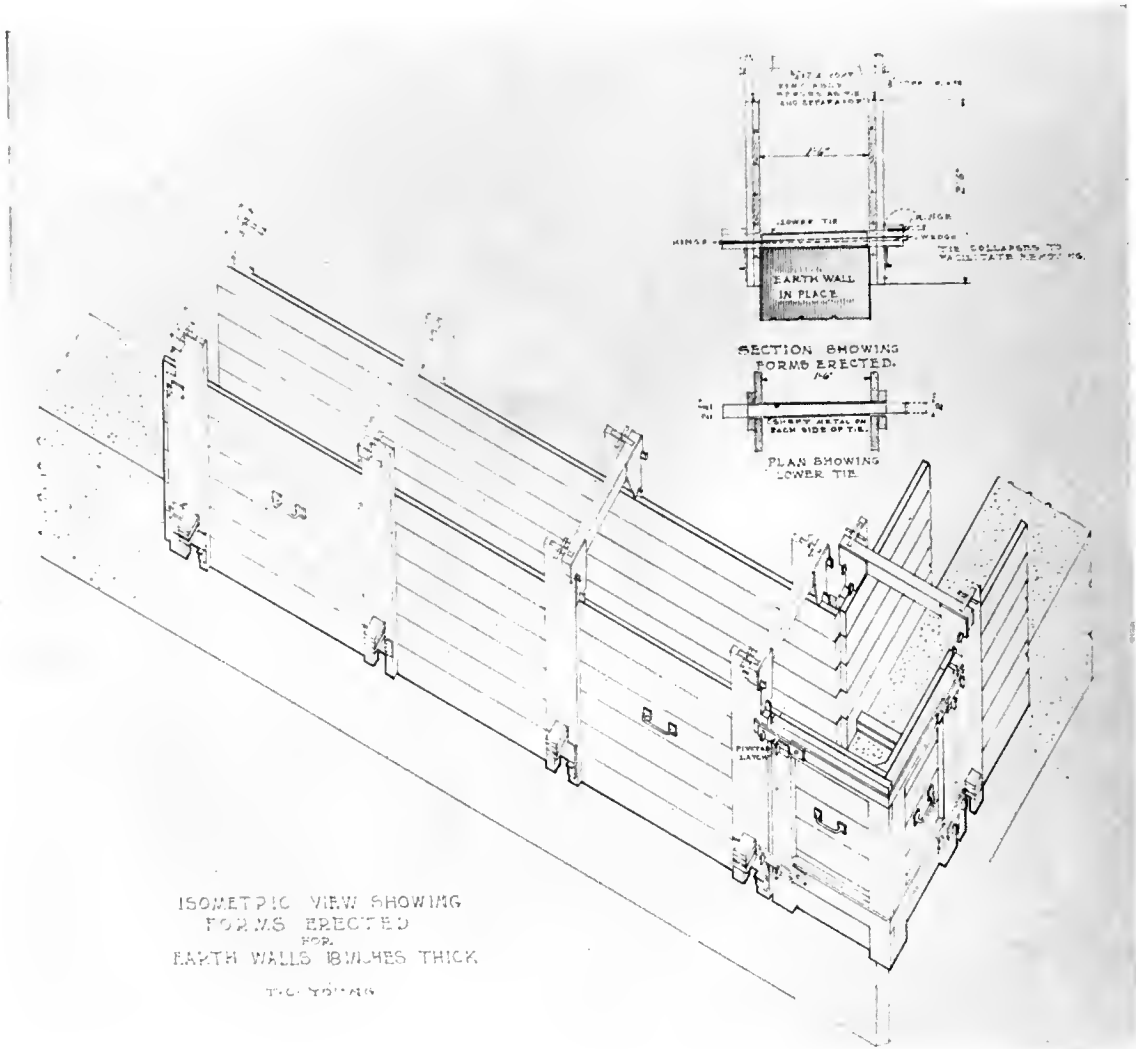

EARTH HOUSE, ST. LOUIS, MO.
THOMAS CRANE YOUNG, ARCHITECT

many parts of the United States, all tending to show a very general desire for simpler and less costly methods of building than those commonly in use.

However, it seemed highly improbable that earth could be compacted by hand sufficiently to stand in a wall until the result of a few experiments had been obtained, made with dry earth tamped into "briquette" form, and tested in the manner customarily

Of course, these few tests are of no scientific value, but may serve, perhaps, to indicate the desirability of a more thorough investigation of the physical properties of compressed earth by qualified experts.

But if such walls as these had been successfully used at one time they could be in another, and the evidence seemed to justify the making of an experi-

THE AMERICAN ARCHITECT

ment in actual construction at the first opportunity. Fortunately, there was little difficulty in persuading the superintendent of the David Rankin, Jr., School of Mechanical Trades to permit the attempt to erect with earth masonry a small building for the storage of oil and gasoline on the school premises. While this building was to be only ten feet by thirteen feet in plan, it must be roofed and provided with a door and window and so would possess most of the elements of a larger house.

This experiment has convinced the author that earth may be used successfully for the walls of small dwellings, for farm buildings, for fences and garden walls or similar purposes—possibly for army cantonments. But the application of this or any new system of construction to actual use will no doubt entail considerable preliminary study of building processes and may require some slight modification of the usual forms of architectural details.

There are many advantages that would follow a more general use of earth construction, not the least of which would be a diminution in our enormous annual waste by fire and a supplementary saving in the consumption of new lumber—the country's supply of which, we are told, is becoming rapidly depleted. Besides, there would be no waste like that in concrete construction, for the same wooden forms or boxing can be used for an indefinite time on any building.

Earth walls, besides being fireproof, afford a very efficient protection against extremes of temperature and there may be opportunity for the inventor in devising an equally cheap and effective construction for floors and roof.

One of our most serious problems is that of transportation, which constitutes a large factor in the cost of building. Some of this expense is, of course, unavoidable, because certain manufactured products, such as iron pipe, plumbing fixtures, glass etc., must be used in any case. But with earth already on the premises substituted for other manufactured materials used in walls, a large part of the transportation charges would be eliminated.

The possibility of improved artistry in earth building seems unlimited. The thicker walls permit an effect of stability now absent in most of our house designs, particularly of the cheaper sort, and a knowing use of color on the plaster covering might give distinction to a simple building at little cost. The use of plastic decoration with color added suggests the possibility of an architectural development which might become distinctively American.

While there may exist at present prejudice against the use of earth as a material fit only for the dwellings of the very poor, it seems possible that further study by architects and engineers might develop a system of building altogether satisfactory from the

standpoint of cost, construction, sanitation and aesthetics.

The writer feels that a single attempt at earth building has not furnished sufficient data for the preparation of a real specification, but perhaps a few hints derived also from such literature as was available may be useful to any one wishing to undertake a similar experiment.

While in this case a foundation of concrete extending about 8 inches above the surface of the ground was used, it is probable that an earth foundation would answer as well if thoroughly protected by a waterproof coating.



Front view showing finished building
EARTH HOUSE, ST. LOUIS, MO.
THOMAS CRANE YOUNG, ARCHITECT

The earth used in building the walls was obtained by grading the site and from the foundation trenches. The best results were obtained with a mixture of stiff yellow clay and top soil in the proportion approximately of one part clay to two parts loam.

The earth should be free from roots, twigs or vegetable substances and should contain no lumps of clay or gravel larger than will pass through a $1\frac{1}{4}$ inch mesh screen. In tamping the gables, we used earth sifted through a $\frac{1}{4}$ inch mesh screen, and obtained a smoother wall. When placed in the form the earth should be only slightly damp, and until used it should be protected from rain by a shed, tarpaulin or other means; it should be placed in the forms in thin layers not more than 4 inches thick, pressed down with the feet and rammed until solid with a wooden rammer, and so on until the boxing is filled. The end of each section of wall should be tamped to a slope which will form the joint with the next one added horizontally; joints in successive courses should not fall over those in the lower course. Great force is not needed in tamping; a quick, sharp stroke

is the more effective. Strokes should not be in unison. Wood blocks may be placed in the boxing and tamped into the earth to serve as grounds for attachment of frames, wainscoting, etc. If the top of one course is dry when a second course is laid it should be slightly sprinkled with water to insure adhesion.

Fig. I shows the form or boxing used, placed on the wall, ready for filling. The lower ties are first placed at the proper distances on the wall, then the side pieces are lifted on and the top yoke quickly pressed into place. The steel plates on the yoke are slotted and "halved" with the iron lugs screwed to side pieces and hold the top of the form rigidly in place. A block screwed to the top of the tie holds the lower part of the boxing on one side, and a similar block on the other end of the tie is hinged in order to prevent obstruction on extracting the tie from the wall. For the same purpose the tie is tapered and made in two parts, wedged apart at one end. On removing the wedge the parts come together sufficiently to permit easier passage of the tie through the hole. No doubt this device may be improved. Taking out the ties is the only difficult part of the whole process. When the wall is completed the holes may easily be filled with dry earth tamped in with a hammer or mallet, a little water being first sprinkled

around the edges of the hole. Small defects arising from accident may be repaired in the same way.

No doubt with a suitable apparatus and more experienced labor much greater speed in building may be accomplished than in this case. It took two laborers eleven working days to lay 460 cubic feet of earth, or the equivalent of 10,000 brick, and by applying the local price of each type of labor, one may form his own conclusions as to the comparative cost.

It is almost useless at this time to attempt to make accurate estimates, but it seems probable that earth walls, plastered, can be built at from 50 per cent. to 65 per cent. less than common brick walls without plaster.

In this little building the author has experimented with various forms of waterproofing; with coal tar products applied directly to the exterior surface of the earth; with paint and with waterproofing material in the finishing coat of plaster; but time will be required to determine the necessity of using any of these substances, or of their relative usefulness. The author believes that with improved apparatus and more experienced labor a very smooth surface for earth walls may be obtained and that scientific study may develop some means of hardening the earth so that a plaster coat would be superfluous even for decorative purposes.

Minneapolis Architects Have a "Colony"

MINNEAPOLIS architects now boast of a "colony" of their own. A spacious building of Florentine design, located at Second avenue S. and Twelfth street, was recently thrown open to the public.

"The exterior follows the Florentine style because it lends itself peculiarly well to varied window arrangements," Edwin H. Hewitt, architect stated. "It is built of Indiana Bedford stone, has a frontage of 65 feet on Twelfth street and 110 feet on Second avenue, and is four stories high. The elevator well terminates in a tower in the upper story, and above the machinery is an artist's studio. Even the chimney carries out the design."

One of the unusual phases, according to Mr. Hewitt's plan, is that while each firm will maintain its individual practice, many things will be used in common, such as the library, sample rooms, stenographers' room, blueprinting and specification printing.

The third and fourth stories are especially designed for offices, library, sample room, clients' room, consultation rooms, blueprinting room, contractors' con-

sultation and reference room, stenographers' room, a fireproof vault for permanent records and valuable plans, and large drafting rooms that are subdivided by glass partitions, making them private for each firm, yet easily accessible to others, when consultation or suggestions are desired.

These two floors will house a group of professional men. A special addition on the first floor, and a large part of the basement, will be occupied by professional clubs, such as the Attic club, the Minnesota Chapter of the American Institute of Architects, the Post and Lintel club and the Skylight club. The basement also will contain a model kitchen and tea room, where meals will be served at noon to occupants of the building and their friends.

One of the rooms in the basement will be for the exclusive use of draftsmen who desire to study at night. A professor from the University of Minnesota will be available as instructor in design and the studies will be in the nature of university extension work.

At one side of the building, away from Twelfth street, is a large lot that is to be terraced and developed into gardens in the spring. A colonnaded veranda opens on this space from the first floor.

Two School Buildings in Syracuse N. Y.

JAMES A. RANDALL, *Architect*

(See plate form for illustrations)

Delaware School

A TWO-STORY and basement fireproof, brick school, having an anaemic department on the roof—containing an assembly-hall, gymnasium, public library and stack-room, bank, 17 class rooms, 2 industrial class rooms. Industrial manual training, school manual training, draughting and blue printing rooms, lumber storage and finishing rooms, school cooking, domestic science, dining room, millinery and sewing room, model flat of four rooms, swimming pool, shower rooms, boys' and girls' locker rooms, boys' and girls' toilet rooms, kindergarten, principal's office, reception room, medical and dental clinics, teachers' rest room, reference library, anaemic department containing two class rooms, clinic dining room, serving pantry, store room and covered porch; store rooms, electrical room, boiler room, fan room, coal bunkers.

The school will accommodate 1,000 pupils.

It was built during 1915-16-17-18 and opened in September, 1918.

It cost completely furnished \$343,270.

Mr. James A. Randall was the architect for this structure as well as for the Blodgett Vocational School here described. Illustrations of these buildings will be found in the plate form of this issue.

Blodgett Vocational High School

A THREE-STORY and basement, brick fireproof building containing an auditorium, library, mail office and two private offices, teachers' rest room, two ante-rooms, two dressing rooms, superintendent's office, 8 class rooms, 4 drawing rooms; 14 store, stack and locker rooms; 3 tool rooms, 6 janitor's closets, kitchen, lunch room, faculty lunch room, two physics, chemistry and biology laboratories, physics and chemistry lecture rooms, boiler demonstration, forge foundry, steam fitting and metal working, demonstration, printing, emergency, elementary and advanced machine shops, pattern making, wood turning, elementary and advanced cabinet making, wood working machinery, finishing, dry kiln, lumber storage, lecture, blue printing and dark rooms, two apparatus rooms, dressmaking, millinery, commercial bookkeeping, typewriting, stenography, applied design, laundry, domestic science kitchen, model flat of 5 rooms, motion picture booth, fan rooms, transformers, electrical, electrical generator, boiler room and coal pockets.

Built during 1916-17-18, this structure cost, completely furnished, \$545,000. There are 1,300 pupils accommodated, and thirteen toilets for faculty and students.

Experiments in Art-Teaching in the Schools

THE extremely practical side of the arts was ably emphasized by School Superintendent Corson, of Newark, N. J., in speaking of the approval recently given by the Board of Education to his plan for the extension of the system of intensive teaching of the manual arts throughout the entire school system.

"Art," said Dr. Corson, "is of value to all manufacturing interests. France owes her preeminence as an industrial nation to the fact that she combines beauty and utility in all her products. The high prices these products command in the markets of the world are due primarily to the element of beauty. It would be a mere venture to say how much is paid for beauty and how much for utility, but the ratio is certainly more than half and may be as much as five to three.

"The American schools cannot afford to ignore a principle so clearly seen," Dr. Corson stated. "The

schools must educate all to an appreciation of beauty as an element in manufactured goods of all kinds, and must not only develop a body of consumers, but must lay the foundations for training a body of workers for the factories of the country."

Teaching with such a purpose was scarcely possible under the old system. The action taken by the committee in approving his recommendation is of very great importance. It establishes a new epoch for the teaching of art, of domestic science, of domestic art and of manual training in the schools.

"It has been customary to teach these subjects without much relation to each other," he continued. "Each had its own field, and each was given approximately one hour of time a week. It is not difficult for any one to understand that this was merely playing with these important subjects, or, to put it differently, it was teaching subjects with very substantial educational value in a dilettante manner."

While Dr. Corson felt that considerable gain was made in the manual arts when they were more closely related he felt that the problem of getting the whole value of these subjects had not yet been solved. As he put it, "there was still difficulty in the way of realizing to the full the possibilities in these several subjects. A reasonable time was not available to teach them, for the program of studies was full to overflowing and the demand for time could not be met without a radical adjustment of the schedule."

Having arrived at this viewpoint, Dr. Corson decided to make another move and requested four schools to try out a new schedule devoting a period a day for five weeks, alternating them with other subjects in five-week cycles. The theory was the pupils would make such great gain that the loss in intervening cycles would be comparatively small. In one school it was worked out so successfully that educators from other cities have come to see the plan in operation and the results to be shown.

Another reason for satisfaction in the new move expressed by Dr. Corson was the direct reaction on the pupils. He said:

"In all these subjects there is the element of doing. To make something that is at once useful and beautiful appeals strongly to every one. It calls into activity the ability of the pupil. The purpose of an academic education is largely to train and to prepare for the future, but these motor subjects have an immediate purpose to accomplish. There is immediate use for the principles learned and the making of things gives the pupils a sense of accomplishment and of joy that adults have in doing things that are worth while.

"The time is long past when these subjects can be called fads. It is remarkable that in a great working nation like the United States such rich subjects are decried. That such has been done is due to the strength of tradition and to the aristocratic notion that education was a process of class selection and it was best accomplished by studying the useless or the ornamental merely.

"Chinese education until recently was an extreme example of this kind of an education. It is my belief that the schools of today should train for living in a modern world."

Unwise Building Laws—Written and Unwritten*

By GROSVENOR ATTERBURY

THE housing problem is above all the construction problem and the construction problem is the elimination of waste. And one of the causes of building waste is arbitrary and unintelligent regulation—which is what I am asked to discuss.

Now unwise laws are *taxes*, and fall like rain on the just as well as on the unjust. And the unjust fellow is the one who usually gets the umbrella! The incidence of building codes like the incidence of taxes is apt to work injustice. It is the honest builder and the innocent public who pay the Jerry Builders penalties.

So one is tempted to say that all building laws are unwise. But of course that is not quite true. In so far as they are teaching codes and not taxing codes they are beneficial. And if we could be sure of honest and skilled administration our building codes could consist of just two words—"anything safe."

But since unfortunately we cannot yet write our building laws on this basis, we must content ourselves with certain obvious improvements in the existing system. As far as possible our codes should be standardized throughout the country. "Factors of safety" should be reduced to the basis of honest construction. And in the last analysis, to lower our

"Factors of Safety" we must raise our standard of morals.

"One-two-four concrete" should not have to compete against "One-five-ten-twenty Concrete." The \$20 ingredient should be eliminated. This means honest, well-paid inspectors.

Superintendents of construction should be licensed—like drug clerks—and held responsible. The burden of protecting against fraudulent construction should be transferred from the Building Departments maintained at the cost of the taxpayer, to the building—at the cost of the dishonest constructor.

We should have special sections in our codes governing the little house—the laboring man's house. Generic laws are sure to pinch some there and the smallest house deserves the greatest consideration. In the aggregate it represents the greatest investment, quite aside from its paramount importance in welfare of the community.

But besides the written building law, there are certain unwritten laws that actually control building operations today, and I am going to take the privilege of extending the content of my subject so as to include these invisible codes; for the simple reason, that in my judgment they much more vitally affect the cost of the working man's home than the written laws.

*Speech Before the National Housing Association's Conference, Bridgeport, Conn.

The written laws consist of the building and housing codes and the insurance regulations, while the unwritten law is based on the rules of the labor union, the trade agreements of the materials producers, distributors and contractors and certain "Unholy Alliances" between them all.

In the last analysis our troubles are not so much in our building code as in our code of morals. Too many of our buildings are laid up in graft instead of honest old fashioned mortar!

It is the same kind of malady that has caused a good deal of our present business depression. I was talking with a banker the other day and he said the same thing apropos of America's foreign trade: That South American merchants would buy goods from American agents on sample and then get goods that were nothing like what they bought. He said the only trade mark in the world that was 100 per cent. good was the English trade mark. We are losing our foreign trade, and we will never recapture it until we are honest in our trademarks and deliveries.

That is a very unfortunate thing to have to say of your own country, but I am afraid it is true. And it runs through many of our industries, and much of our construction work, and the point of incidence where it hurts and pinches as much as anywhere else is in the workman's own housing!

The unwritten laws in my judgment are the most sinister and the greatest surtax on the small house. The big fellow can afford to pay those taxes perhaps, but the little man cannot.

Let us make a guess, for example, at the price which the little fellow, usually the working man himself, is liable to pay for all those factors of dishonesty and waste—we might call them "Surtaxes." They might be roughly but conservatively apportioned as follows:

To unwise Building Codes—probably not more than 10 per cent.

To labor—stifled production—6 hours real work for 8 hours pay, and arbitrary rules against economic use of labor and materials (the workingman's own contribution) let us charitably say 25 per cent.

To material, through "Unholy Alliance" between producer, distributor, builders and certain "misleaders" of labor—to put it modestly—25 per cent.

In short, for every \$100 worth of home he pays \$160; in many instances, of course, a great deal more, but my figures are simply to visualize the situation. And of this surtax of \$60 the greater part, let me repeat, is not paid under the written, but the unwritten law. The great bulk of it must be charged to our code of morals.

Yet there are certain sections in many of our building laws that are disgraceful to our intelligence as these dishonest practices are to our morals.

I read recently the interesting statement that the

foundations normally placed under a small house would, if properly designed, support 23 houses of the same size. That is a little misleading, because, of course, the writer meant that if you could arrange the 23 houses so as to bring the load down to a point of concentration and meet it with a concrete pillar, you could put 23 houses on a pillar containing no more concrete than that put in the cellar of one of the houses; but it is an illustration of the situation.

I read also a discussion as to whether 6-inch cinder concrete walls cannot be substituted for the 8-inch wall of brick or gravel concrete; also as to whether certain co-efficients and factors of safety could not properly be reduced for special cases.

I might add that, as an illustration of what can be done in economy of material, some years ago I put up 15 or 16 houses with a concrete wall section in which there was 60 per cent. of voids, the inner and outer shells of the sections being but an inch and a half thick.

As to the "Unwritten Laws"—we should have a trade union reformation. We should have membership on the basis of efficiency like the old Guilds. We should substitute leveling up for leveling down, and in place of the slogan "An injury to one is the concern of all," we should put "the benefit of all is the concern of each one." Obviously we should eliminate all rules restricting output in construction.

To sum up, there are a half dozen very obvious things for us to do:

1. Standardize Building Codes throughout the country.
2. Base co-efficients on honest construction and engineering practice.
3. Put the burden of "protecting the public" on the builder—license the building constructor and superintendent.
4. Eliminate the "Unwritten Laws" of waste, limited production and graft.
5. Provide a special section in the building code covering the little house—the laboring man's home.
6. Secure the aid of the Government in scientific research and study for the housing industry.

And in explanation of this last item on the program, let me add that we do not want subsidies from the government to build houses. But on the other hand, we are entitled to the same kind of aid in the housing problem that the Department of Agriculture gives to the farmer. Let us hope that when they organize a Department of Social Welfare or whatever they choose to call it, they will co-ordinate the various useful agencies now functioning in different government bureaus, in such a way that they can all be brought to bear on the problem of home construction. The efforts of this association might well be exerted toward influencing the Government to take that action.

*Doorway, Trinity Church,
Newport, Rhode Island*

(See reproduction of original drawing by O. R. Eggers on opposite page)

In a preceding issue a general view of Trinity Church was presented. Mr. Eggers' admirably executed sketch of the doorway shown herewith offers excellent suggestions. The quiet dignity of this old church, as it stands surrounded by its graveyard, will impress the visitor.

Trinity was built in 1726, but by whom designed no one has yet been able to discover. In 1762 the church was sawed in two and lengthened so as to about double its original capacity. But so reverently was this church regarded that nothing was done then, or since, to impair the original effect and character of the interior.

This doorway indicates the conscientious attention with which the Colonial builder-architect worked. Its moldings and fluted pilasters show the handmade work that makes a Colonial detail a thing of art and beauty as opposed to the machine cut moldings of the present.

"In their narrow beds, forever laid, the rude forefathers of the hamlet sleep." Their resting place is in the shadow of the church, and the whole locality is one to make for quietness and thoughtfulness.

The two story meeting houses in New England are of unusual interest, and while many of them architecturally present a better result, we doubt if any of our early churches have received more solicitous care or have been more reverently regarded than Trinity at Newport.



DOORWAY, TRINITY CHURCH, NEWPORT, RHODE ISLAND
THE AMERICAN ARCHITECT Series of Early American Architecture



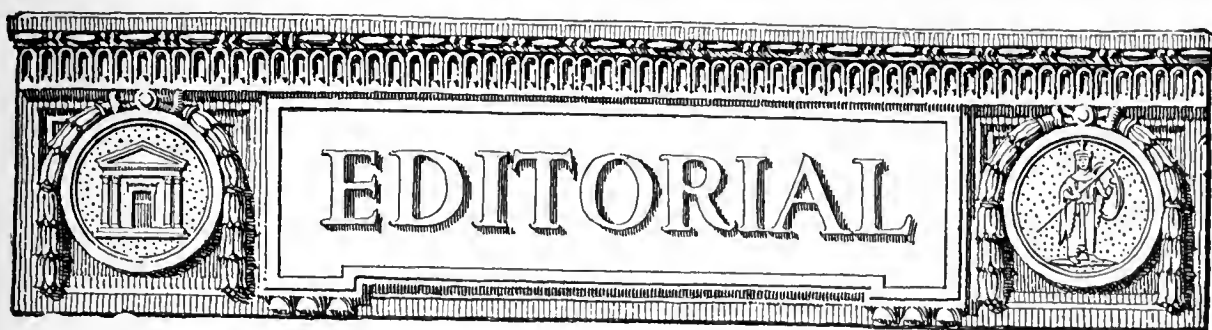

More Skilled Workmen for the Building Trades

SENATOR WILLIAM M. CALDER, chairman of the Senate Special Committee on Reconstruction and Production, has recently completed a nation-wide survey of the housing situation of the country. As a result of his investigations he believes that one of the most important problems confronting the construction field today is the matter of securing skilled workmen in the building trades. It is almost commonplace to refer to the demand for building now impending. It would be most unfortunate if that demand were augmented by a lack of skilled workmen after other deterrent factors had been adjusted.

With this in mind, Senator Calder has addressed a letter to the Governor of every State in the Union, urging that steps be taken to establish trade schools in the several states for the purpose of encouraging young men to learn the building trades.

The young American has shown a tendency to ally himself with trades which require a certain amount of skill. Hence we find among the electricians, the plumbers and the masons numerous young men of American birth. This, however, is not the case in the other building trades. These have been left more largely for men from foreign lands, who, dissatisfied with the conditions in their fatherland, have come to this country, and, without training or technical apprenticeship, have started at the foot of the ladder to try for success. The war has cut off this source of supply. Without trained workmen, and in sufficient numbers, the building program will be unnecessarily delayed.

It is therefore reasonable to consider Senator Calder's suggestion to foster building trades schools. Technical training is always useful, and to get it intensively and systematically in a recognized school is equivalent to a large amount of experience.

ANOTHER fact which Senator Calder's committee has revealed is that the supply of labor is depleted through over-specialization. Certain trades, such as paper hanging, have a busy season and a dull, with the result that these trades must be

highly paid, or else the men engaged therein must be competent to function in other trades in the off seasons. If apprentices might be trained in trade schools in a sufficiently wide range of related activities to enable them to adjust themselves to changes in industrial conditions and seasonable demands of the construction industry, it would be a direct benefit not only to the tradesmen themselves but to the general public. The constant leaving of affairs to chance is one of the deplorable tendencies of American life. The way in which we chose our professions, or the way in which the humbler trades are entered—arbitrarily and with no thought of the larger needs or the larger results, is shiftless and un-American. When the cry is for skilled workmen for the building trades, the answer must be to train the workmen, and not leave the fulfilment of our enormous building program to accident and the whims of workers.

The American Specification Institute

THAT the subject of specifications is one that receives the serious consideration of architects is evidenced by the many communications received in response to the editorial printed in *THE AMERICAN ARCHITECT* of November 17, 1920. Excerpts from a few of these have been printed in the issues of December 15-22. Unexpectedly, but not without reason, communications have been received from manufacturers of building materials. These interests are concerned with proper specifications, as they often suffer damage through those improperly written. The owner can also suffer a loss from the same cause. When the specification is capable of human interpretation and execution, the contractor becomes an implement of construction and in a measure an impersonal element. Responsibility is the attribute of the architect alone, as he produces the specification and supervises its fulfillment.

The importance of the person who writes the specification is becoming better appreciated. Anything which will aid him in improving his product should receive the hearty support of all parties to the construction of buildings and other structures.

THE AMERICAN ARCHITECT would presume to suggest to those having in hand the formation of *The American Specification Institute* a consideration of

those organizations that are engaged now in work that is an element of specifications. The very important work of the American Society for Testing Materials very wisely can be left in charge of that organization. In like manner the same applies to the specifications of the American Societies of Illuminating Engineers, Heating and Ventilating Engineers, Mechanical Engineers, Civil Engineers; the American Institutes of Electrical Engineers, Mining and Metallurgical Engineers, The American Concrete Institute, The National Fire Protection Association, The American Railway Engineering Association and others produce very excellent and valuable specifications for construction and the assemblage of materials.

The American Institute of Architects and the independent state and local architectural organizations also have rendered valuable service in adding to specification knowledge and standards.

In fact, a close and intimate relationship between *The American Specification Institute* and all these organizations is essential that it may become the clearing house of their efforts in so far as the writing of specifications is concerned. Having in hand only one thing, it can take the findings of these organizations and reduce them to exact and specific data for actual use. There is no reason why a hearty co-operation should not obtain between them.

The plan and scope of *The American Specification Institute*, which it is understood will soon be ready for general publication, will be studied with interest.

Prices

TODAY'S problem is the price problem.

On page 107 of this issue there appears Part 1 of an important article by Edmund D. Fisher, vice-president of Bank of Detroit. It is "A Study of Prices."

Mr. Fisher shows just what prices are and what affects them. It may seem a trifle curious to a reader of this journal to intimate that it is necessary to have explained to him such a subject, but it is only too true that architects, as well as other business men, are sometimes apt to explain a great many things by that old and time-honored "supply and demand" catchword.

Supply and demand is a real factor, no doubt, but is it thoroughly *understood*?

What Mr. Fisher has to say is fact, based upon

fundamental economic principles. To read his article is to understand better the so-called price trend. And what is of more interest and real "dollars and cents" value to the architect at the present moment than that thing which will further help him to gain a better perspective of prices and which will increase his knowledge of the factors necessary to bring about an orderly decline?

Fine Arts in the Government

A SECRETARY of the fine arts has been rumored as a possibility for the Harding Cabinet. The Arts Club of Washington has started a movement to induce Congress to create a Department of the Fine Arts.

Precedent for such an office is furnished by the French cabinet, where the minister of education is also minister of fine arts.

This would involve the establishment by the government of a great national school of music, drama, painting, sculpture, architecture and their allied branches.

That such a school under the protection of the national government would improve art education all over the country is without doubt. Every art school would have to raise its standard of instruction in order to be eligible to become an authorized branch of this great national school.

It would be able to develop an appreciative attitude toward art among those vast groups of the general public where now such an appreciation is almost negligible. By proper educational publicity methods, much good might be accomplished. The numerous organizations now independently furthering the progress of the fine arts could unite their forces and exchange experiences in a manner that would enable each to reach a far larger audience than individual efforts now make possible.

Politicians will undoubtedly raise the objection that this should not come to pass at a time when retrenchment of governmental expense is in progress, especially in view of the fact that we do not even maintain a Secretary of Education. But if it were possible to take that important step it would be fitting, and an augury of hope, if extended official attention were given specifically to the fine arts. The amount of constructive, valuable work that could be accomplished by a competent executive mind would far overbalance the financial outlay.



DELAWARE SCHOOL, SYRACUSE, NEW YORK
JAMES A. RANDALL, ARCHITECT



DETAIL OF MAIN ENTRANCE
DELAWARE SCHOOL, SYRACUSE, NEW YORK
JAMES A. RANDALL, ARCHITECT

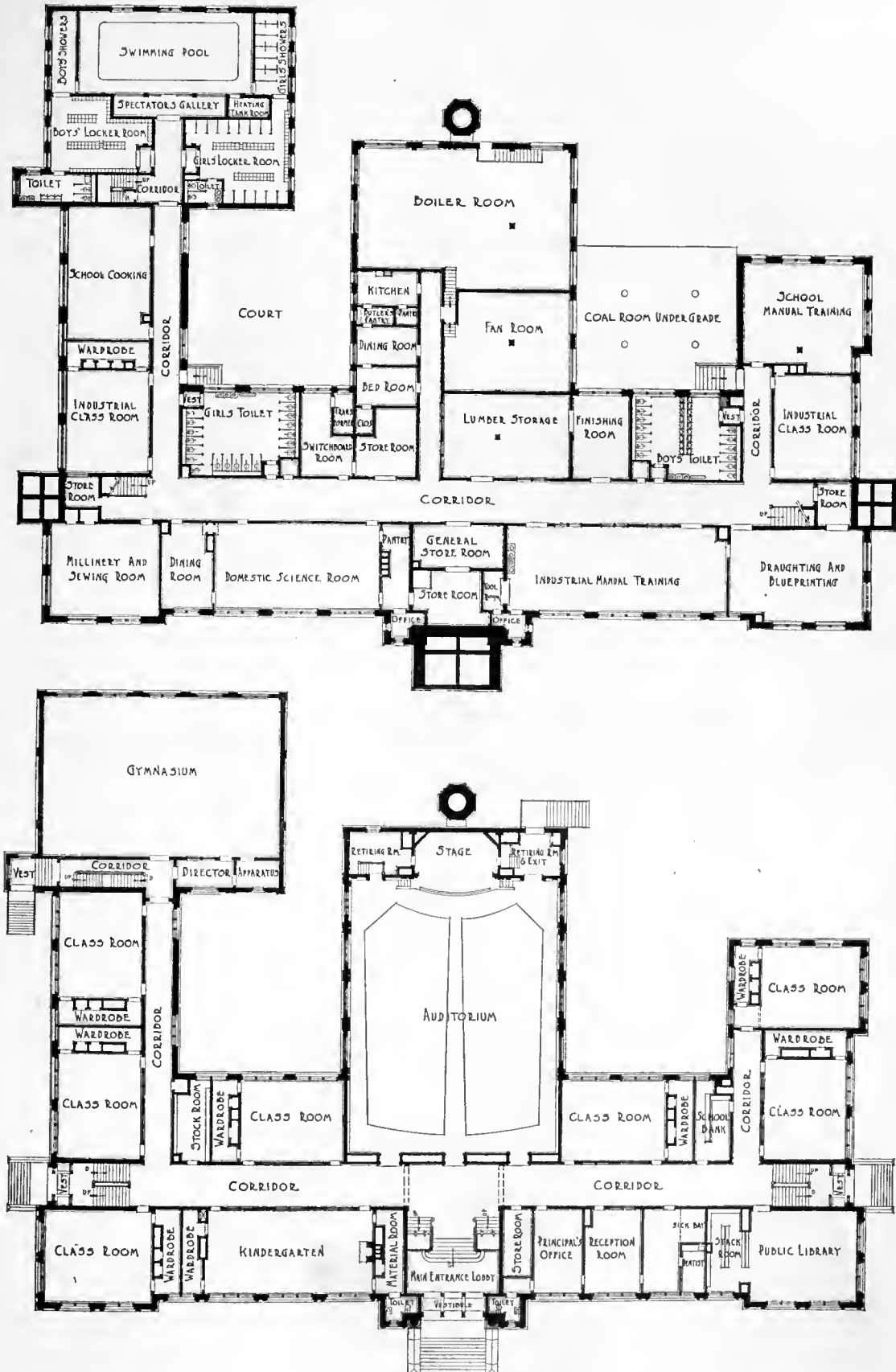

BASEMENT AND FIRST FLOOR PLANS
 DELAWARE SCHOOL, SYRACUSE, NEW YORK
 JAMES A. RANDALL, ARCHITECT

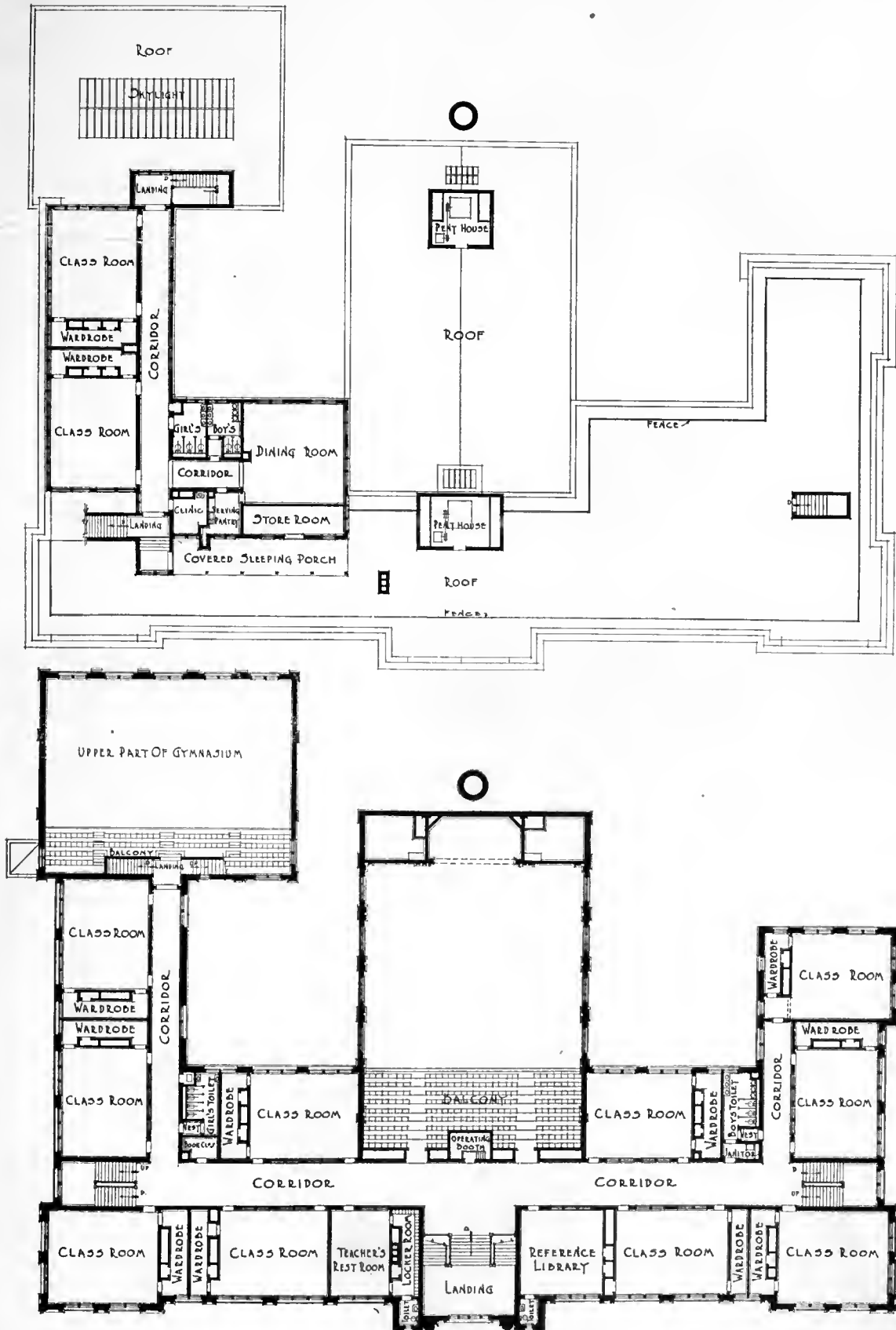

SECOND FLOOR AND ROOF PLANS
 DELAWARE SCHOOL, SYRACUSE, NEW YORK
 JAMES A. RANDALL, ARCHITECT



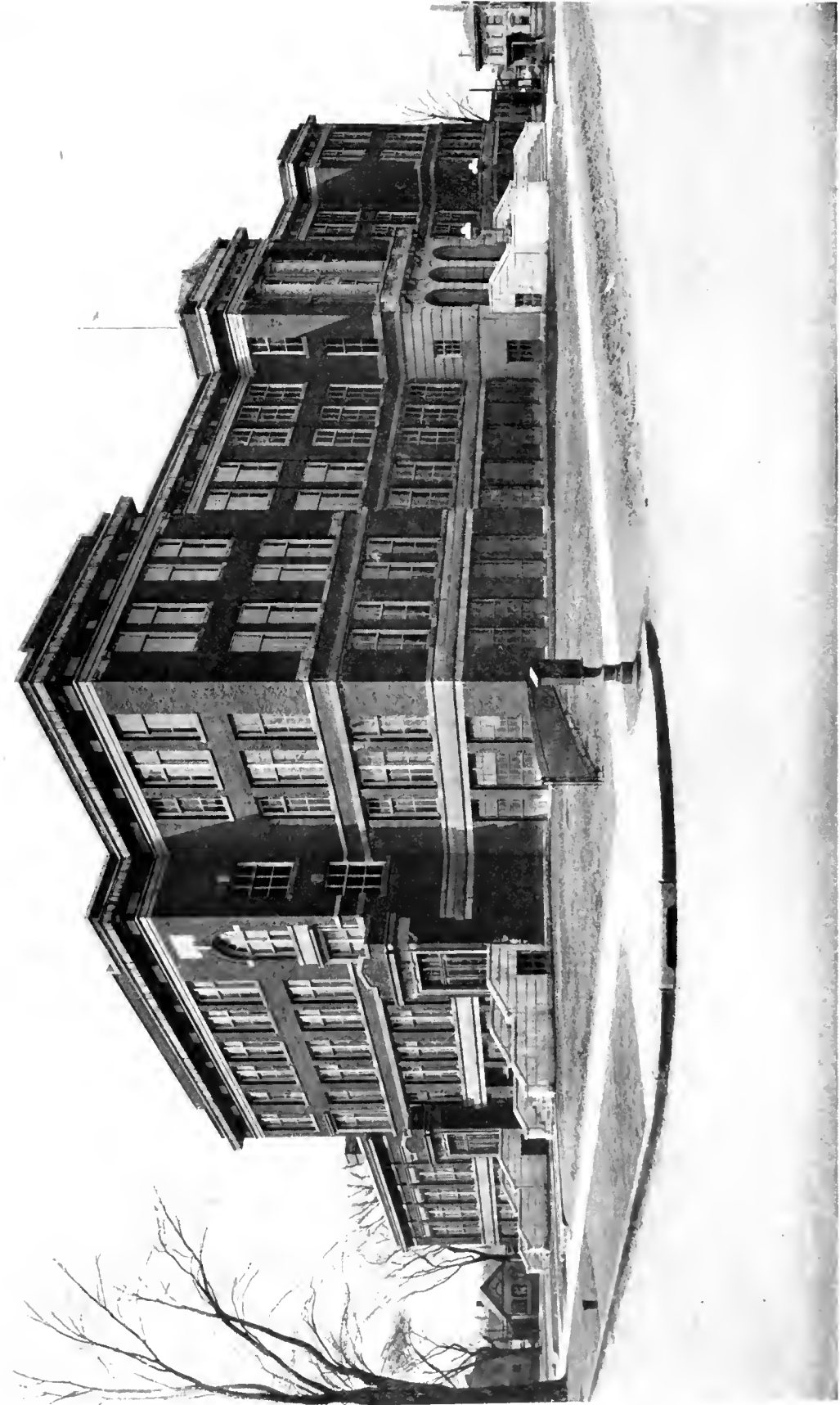

BLODGETT VOCATIONAL HIGH SCHOOL, SYRACUSE, NEW YORK
JAMES A. RANDALL, ARCHITECT

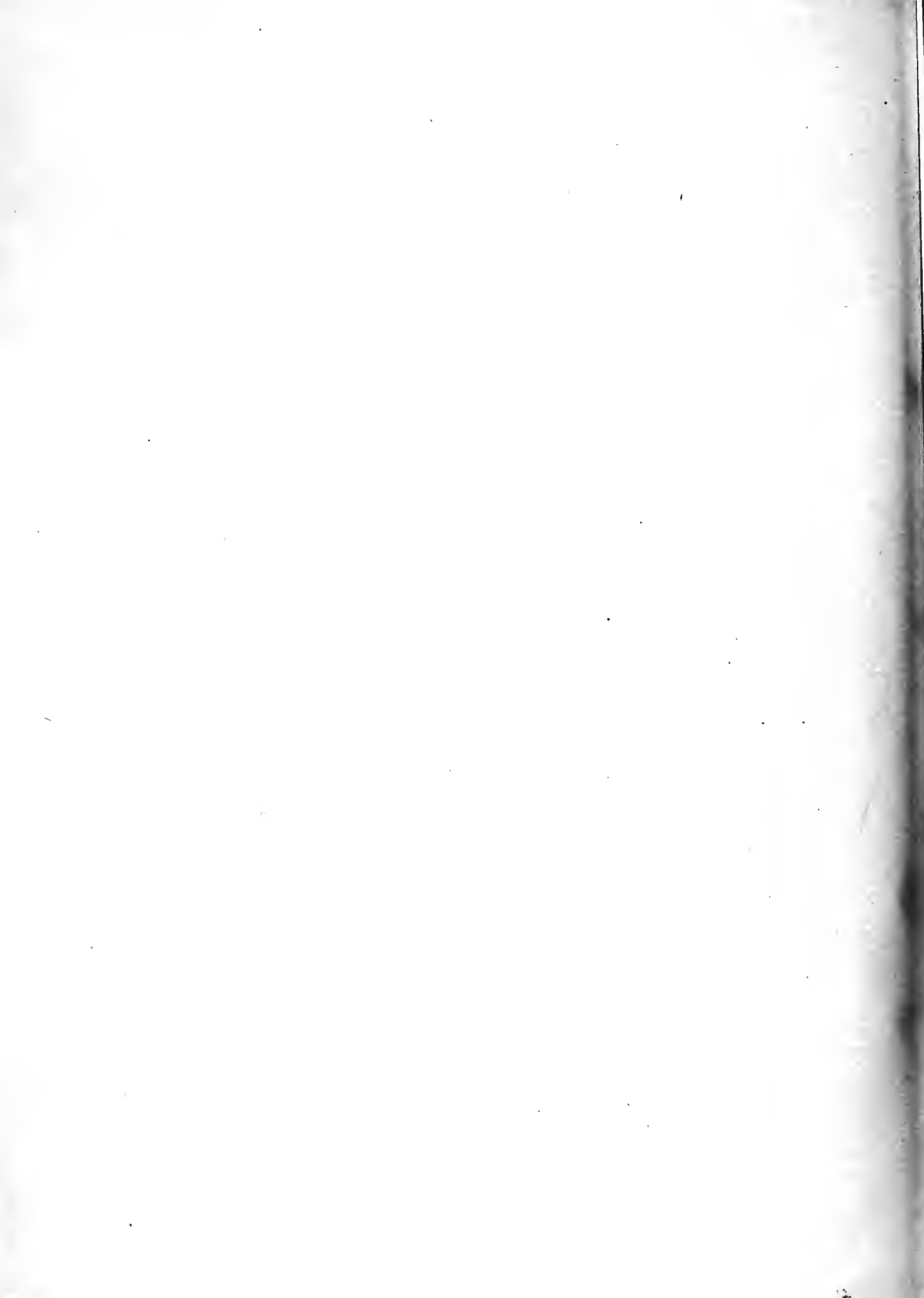

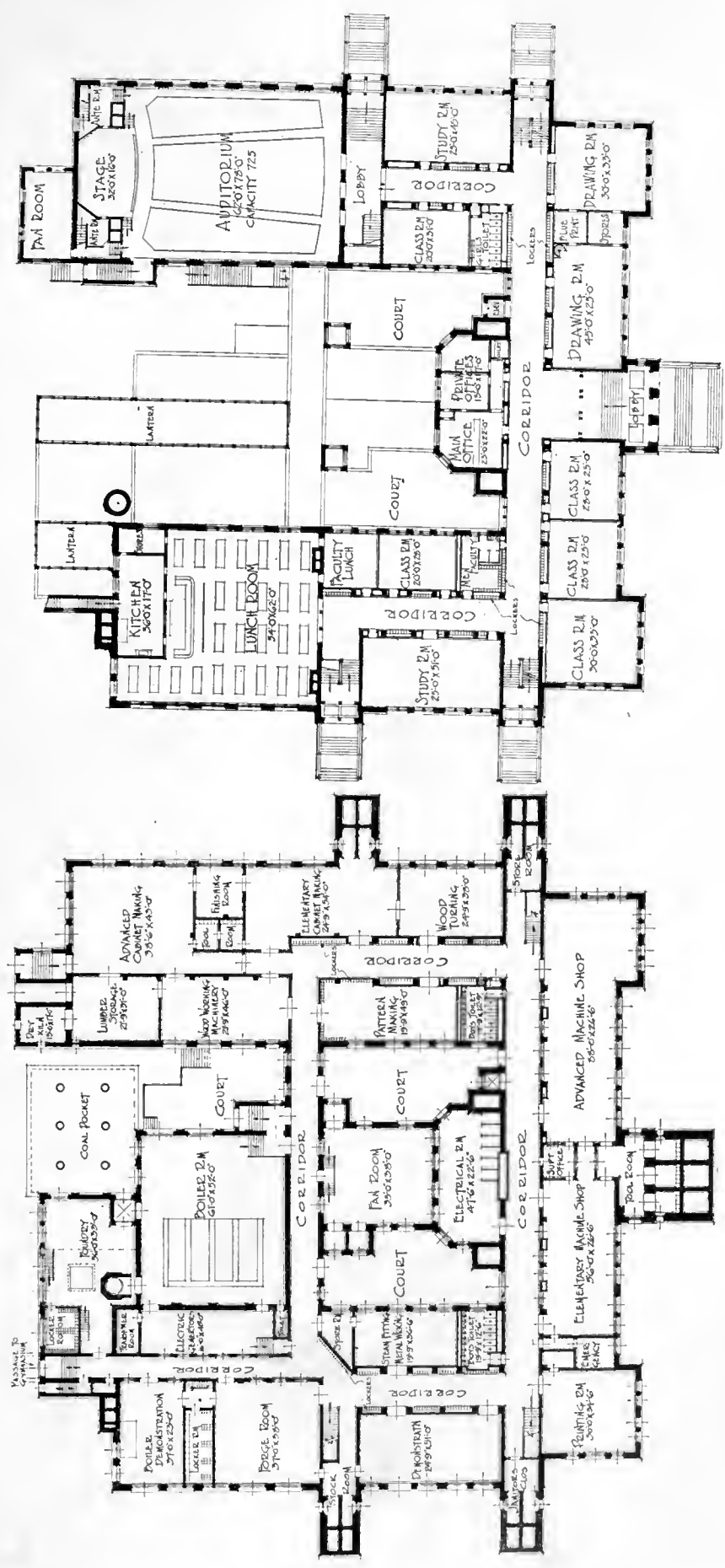

BASEMENT AND FIRST FLOOR PLANS
 BLDGETT VOCATIONAL HIGH SCHOOL, SYRACUSE, NEW YORK
 JAMES A. RANDALL, ARCHITECT

THE UNIVERSITY OF CHICAGO PRESS

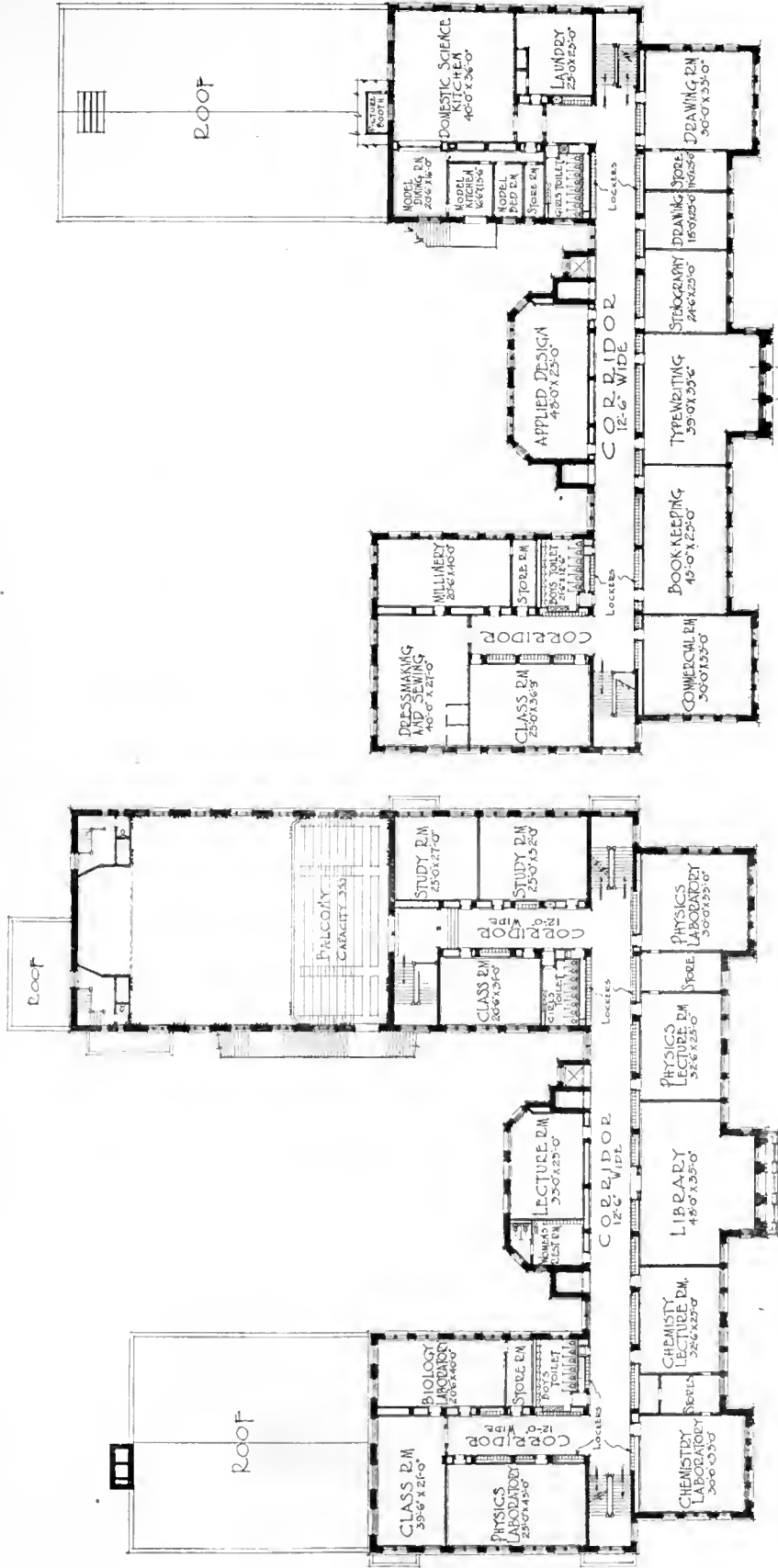

SECOND AND THIRD FLOOR PLANS
 BLODGETT VOCATIONAL HIGH SCHOOL, SYRACUSE, NEW YORK
 JAMES A. RANDALL, ARCHITECT

98

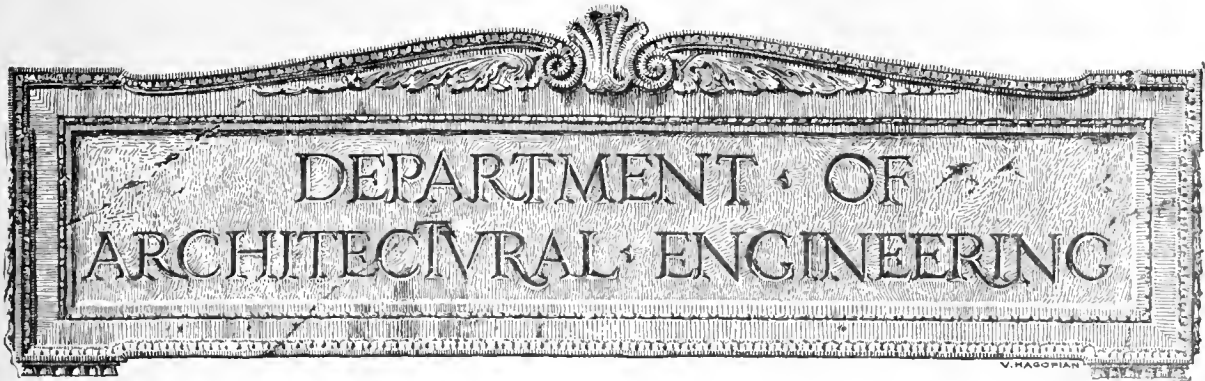

Heating and Ventilating Industrial Buildings

Part III. (Continued)

Hot-Blast Systems

By CHARLES L. HUBBARD, *Heating Engineer.*

A TYPE of building frequently used for machine work and similar manufacturing processes is shown in Fig. 1, and is well adapted to hot-blast heating. In small and medium size buildings a single fan and heater unit is placed near the center, and main distributing ducts run in both directions toward the ends. In the case shown, two heating units would be used, one on either side of the central bay, near the center, in order not to interfere with the traveling crane beneath the monitor. The main distributing ducts are run through the roof trusses and branches are brought down on posts to within 5 or 6 feet of the floor and turned so as to discharge at a slight angle toward the outer walls. The galleries are supplied through shorter branches as indicated. The arrangement for a one story building, without galleries, would be the same as shown in Fig. 1, by omitting the upper inlets.

CONDITIONS FOR SUCCESSFUL OPERATION

Arrangements of this kind work well when the horizontal distance from the air inlet to the outer wall is not greater than 20 feet. When the distance exceeds this the air may be blown straight downward from the inlets instead of at an angle and another row of inlets should be ranged along each outer wall or near it. Another way, for a wide building, is to place the warm air inlets as shown in Fig. 1, and carry return ducts along the outer walls with openings near or in the floor. In this way the warm air is drawn over toward the outer walls where it is most needed.

In machine shops, where most of the occupants are

actively engaged, a normal temperature of 60 to 65 degrees is considered ample, while the offices and drafting room should be maintained at 68 to 70 degrees in the coldest weather. It often happens that while the lowest continued temperature does not fall below + 10 degrees, or possibly zero, there may be infrequent periods when it falls to - 10 or - 20

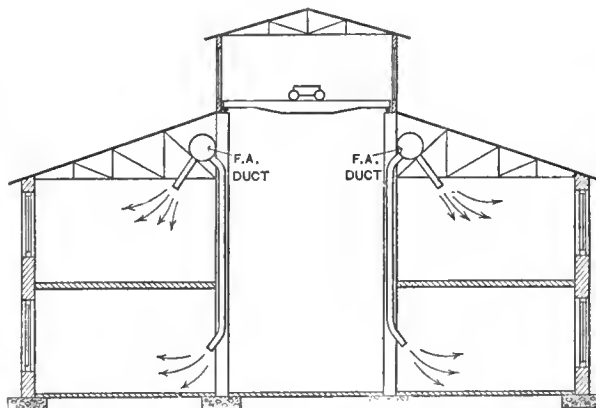

FIG. 1. AN ARRANGEMENT OF DUCTS SUITABLE FOR MONITOR ROOF CONSTRUCTION

degrees. It is usually sufficient in cases of this kind to proportion the heating equipment for zero and take chances on the short duration of colder weather in plants where the men are more or less actively engaged, as in machine shops, foundries, forge shops, etc. For example, a shop designed for a temperature of 60 degrees in zero weather will only fall

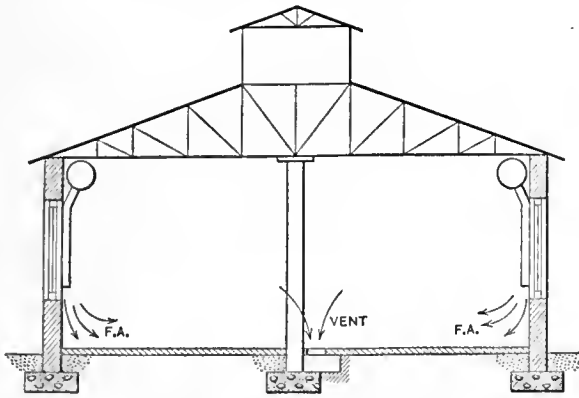

FIG. 2. FOR FOUNDRIES THE ARRANGEMENT OF SUPPLY AND EXHAUST DUCTS HERE SHOWN WILL PRODUCE GOOD RESULTS

to 52 degrees when it is 10 degrees below zero, which will not prove especially uncomfortable in any cases.

The air volume to be supplied in a building of this general type is more commonly based on heating with re-circulated air in zero weather. In cases of this kind the total heat loss by transmission and leakage is first computed for zero outside, and sufficient air circulated to offset this with a temperature range of 80 or 90 degrees.

EXAMPLE

The total heat loss from a shop is 1,000,000 thermal units per hour in zero weather. The building is to be warmed by recirculating the air, returning it to the heater at 60 degrees and delivering it through the warm air inlets at $60 + 80 = 140$ degrees. What volume of air must be moved by the fan per minute to supply the required amount of heat? Here we have

$$H = 1,000,000; T = 80; \text{ to find } V.$$

Substituting these in the formula previously given we have

$$V = \frac{55 \times 1,000,000}{80} = 687,500 \text{ cubic feet per hour or } 687,500 \div 60 = 11,460 \text{ cu. ft. per minute.}$$

When there is an abundance of exhaust steam, or the number of workmen is large compared with the cubic contents of the building, a volume of outside air equal to one to three complete changes per hour should be supplied in the coldest weather, increasing this to 30 or 40 cubic feet per occupant per minute as the outside temperature rises.

FOUNDRIES

Foundries contain more or less steam and irritating gases, and are best ventilated by a pair of fans, one for the supply of air and one for its removal. Ventilation by means of skylights or mon-

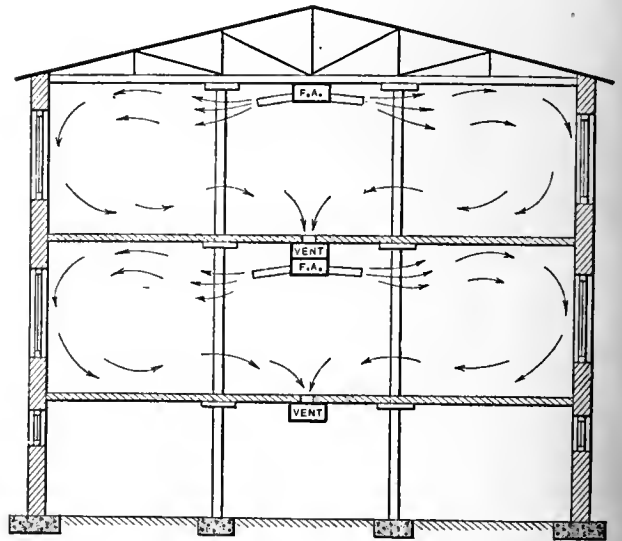

FIG. 4. ANOTHER ARRANGEMENT FOR BUILDINGS SEVERAL STORIES HIGH

Both supply and exhaust ducts are carried on ceilings

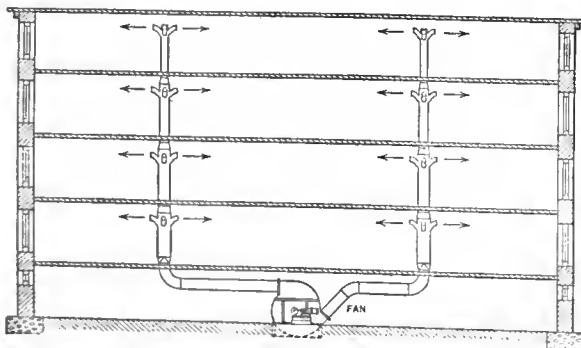

FIG. 3. STAND PIPE SYSTEM OF HEATING AND VENTILATING EMPLOYED IN MULTI-STORY BUILDINGS

itor windows, except in warm weather, causes the steam to condense in the presence of the cooler air entering through the windows, thus making conditions worse rather than better. For the best results the air should be admitted and discharged near the floor, as shown in Fig. 2, as this maintains a zone or layer of fresh air in the space occupied by the workmen. Furthermore, the gases which are present are heavier than air and must be drawn off from the lower part of the room. When the work is such that steam and gas are present only in small amounts, the exhaust fan may be shut down; also in warm weather exhaust ventilation may be through the monitor, with a portion, at least, of the fresh air admitted by way of the lower windows. The same gen-

eral method of ventilation may be employed for a forge shop.

The equipment for buildings of this kind is usually designed for maintaining a temperature of 50 to 55 degrees in zero weather. Sufficient fresh air should be supplied at all times to keep the building clear of smoke, and may be based on four or five changes per hour for a stratum 10 or 12 feet high, over the entire floor, for iron foundries and forge shops, and twice that amount for brass foundries.

Shoe shops, jewelry factories and buildings of this general type carrying light machinery, are usually several stories in height and require a somewhat different treatment. Two general plans are employed, as shown in Figs. 3 and 4. The first of these is known as the "stand pipe" method, and is adapted to buildings not over 60 feet in width, unless a double row of supply pipes is provided. The ver-

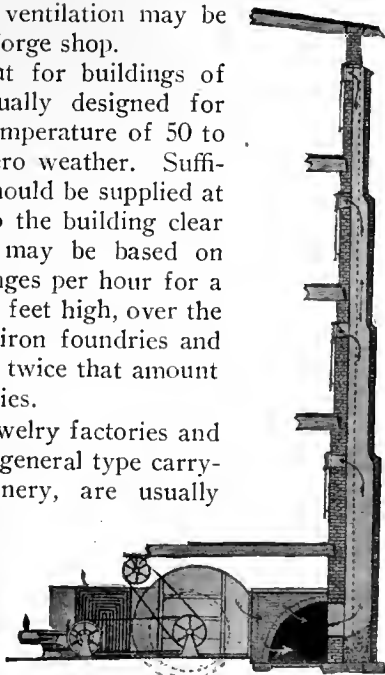

FIG. 5. AN ARRANGEMENT OF AIR SUPPLY DUCT SUITABLE IN TEXTILE MILL

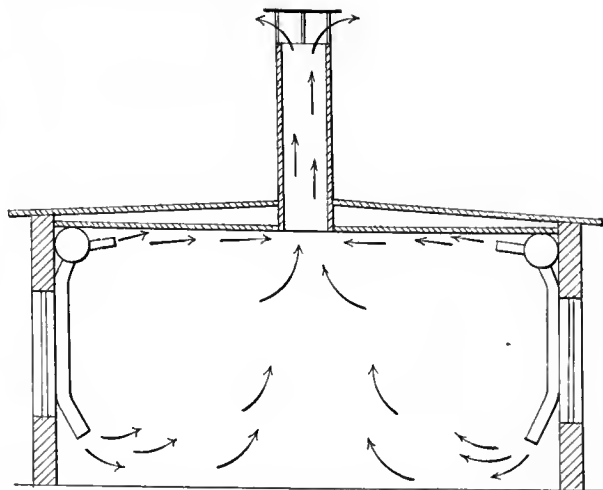

FIG. 7. TYPICAL DUCT ARRANGEMENT FOR DYE HOUSES

tical flues, or stand pipes, are carried up every 80 to 100 feet and discharge warm air in four directions on each floor. In Fig. 4 fresh air and vent ducts are carried on the ceilings, as shown in the cut, and the warm air discharged downward at an angle of 30 to 40 degrees from the horizontal toward the outer walls. With smooth ceilings and ordinary working velocities, the heat will be evenly distributed by this arrangement for a considerable distance, even up to 100 feet or more, if a return duct is provided at the center for removing the cooler air from the lower part of the room.

TEXTILE MILLS

There are two or three standard methods of installing heating and ventilating apparatus in buildings of this general character which may be modified to meet quite a variety of conditions.

One of these is illustrated in Fig. 5, in which case the apparatus is located in the basement and a main supply duct is carried along the outer wall as shown in section in the cut. The uptake flues are of masonry and project from the outside of the wall in order not to encroach upon the space within. The warm air is all delivered at one side of the room and usually toward the colder or more exposed wall. The uptakes are spaced from 40 to 70 feet apart and deliver the air to each story through inlets about 8 feet from the floor. The smooth ceilings commonly found in buildings of this kind offer but little obstruction to air flow, and the moving belts and pulleys tend to break up the currents and assist in the distribution. The flue area, as will be noted in the cut, is reduced at each story and the air quantity for each floor is proportioned by an adjustable deflecting damper. Another flue arrangement adapted to standard mill construction is shown in Fig. 6, in which case a sep-

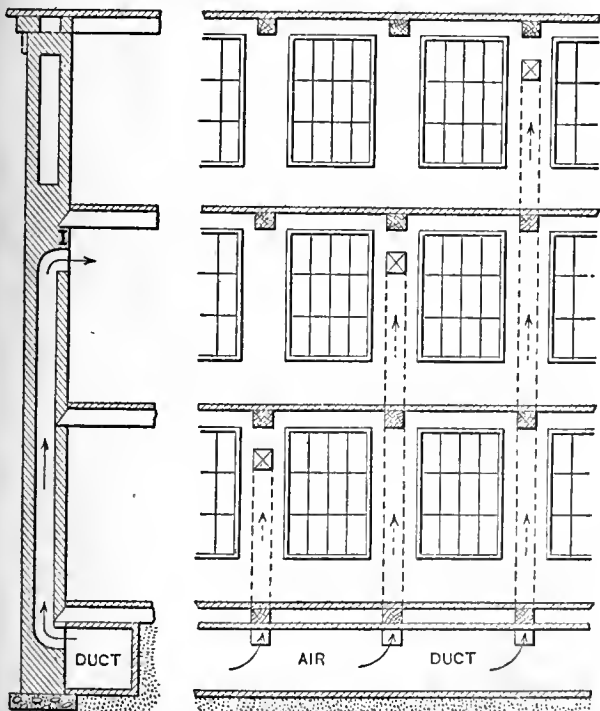

FIG. 6. ANOTHER FLUE ARRANGEMENT ADAPTED TO STANDARD MILL CONSTRUCTION

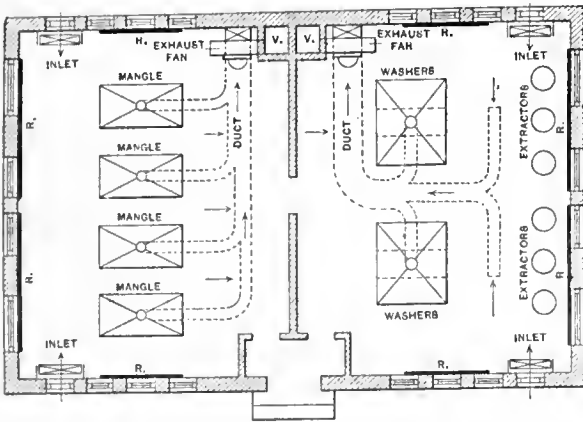

FIG. 8. TYPICAL ARRANGEMENT FOR A LAUNDRY

arate flue is carried from the main air duct through piers between the windows. This has the advantage of avoiding outside pilasters, but increases the number of flues somewhat.

With the piers 12 feet apart, it will be 36 feet between inlets in three-story buildings and 48 feet in those four stories in height.

Textile mills illustrate a class of buildings in which

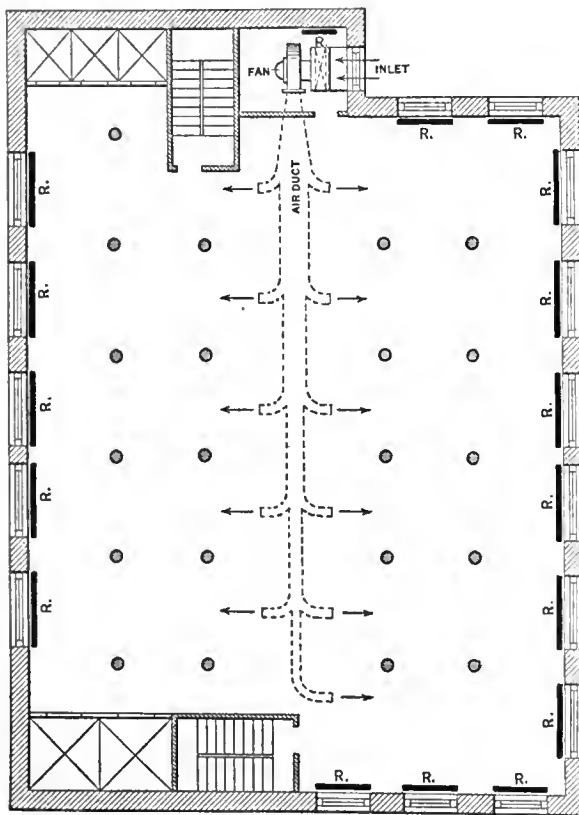

FIG. 9. A SCHEME FREQUENTLY USED IN LOFT BUILDINGS DEVOTED TO LIGHT MANUFACTURING

the humidity of the air must be considered as well as its temperature and volume. In this particular case, if the air becomes dry, frictional electricity is generated by the movement of belts and machinery, and this in turn has a decided effect upon the quality and evenness of the finished goods. This condition may be practically overcome by maintaining a relative humidity of 60 to 70 per cent. at the normal temperatures carried in buildings of this kind. The air may be moistened by means of steam jets or a fine spray of water blown directly into the room when direct heating is employed, or by evaporating pans or air washers in the case of hot-blast heating.

"Air conditioning," which includes the control of humidity is an important branch of engineering, and equipment of this kind should be installed under the

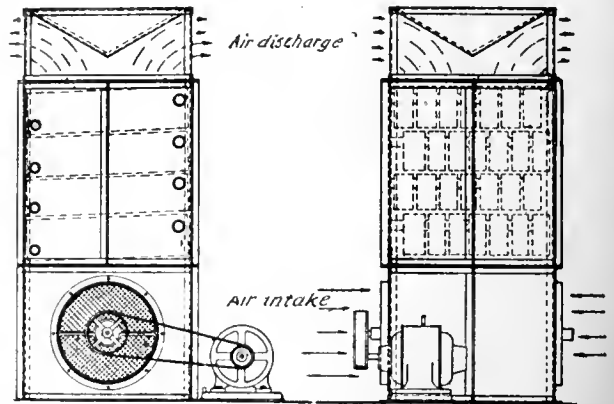

FIG. 10. TYPICAL UNIT HEATER FOR PLACING ON THE FLOOR

direction of a specialist. In connection with the control of humidity, the matter of dust removal must be taken care of not only in certain departments of textile mills, but also in other industries, such as those requiring polishing, grinding, etc. This is best handled by means of a hot-blast heating system, either taking the full air supply from outside or recirculating it through an air washer or wet filter.

DYE HOUSES AND LAUNDRIES

In buildings of this kind the special problem is the removal of large quantities of vapor before it has a chance to condense on ceiling and walls. As is well known to those familiar with dye house ventilation, the greatest trouble comes from the condensation of the vapor which is continually rising in clouds from the dye kettles and tubs. When the steam comes in contact with the cool air which is flowing in from doors, windows or roof ventilators it condenses rapidly, sinking toward the floor, and thus obscuring the view. The method of ventilation employed in cases of this kind is to provide a

sufficient volume of warm air to absorb the moisture by evaporation and then exhaust it before it becomes saturated. The volume of air required for this purpose will depend upon the amount of vapor given off, which is at a maximum when the dye is kept at the boiling point and the cloth passed through it from reels located above the vats. It is common practice to provide for a complete change of air every 2 to 10 minutes, according to the processes carried on in the room, once in four minutes being about the average. The best method of admitting and removing the air in cases of this kind will depend somewhat upon circumstances, but in general the greater part should be admitted near the floor at as high a temperature as is possible without overheating the room, and should be removed through openings in the ceiling. When supplied in sufficiently large quantities this air carries the steam with it in a rising current and absorbs a greater part of it at an elevation above the heads of the workmen, thus maintaining a zone of fairly dry and comfortable air in the lower part of the room. In addition to the general supply mentioned above, it is well to

employed. The vents should not be more than 20 feet apart, and should be properly insulated and drained to prevent any dripping upon the fabrics in process of manufacture, or upon the workmen.

Laundries, in contrast with dye houses, are apt to become overheated, and as the air contains a high percentage of moisture, the conditions are very enervating to those employed there. While open windows and roof ventilators may answer all purposes in warm weather, the free admission of cold



FIG. 11. TYPE OF UNIT HEATER SUSPENDED FROM CEILING

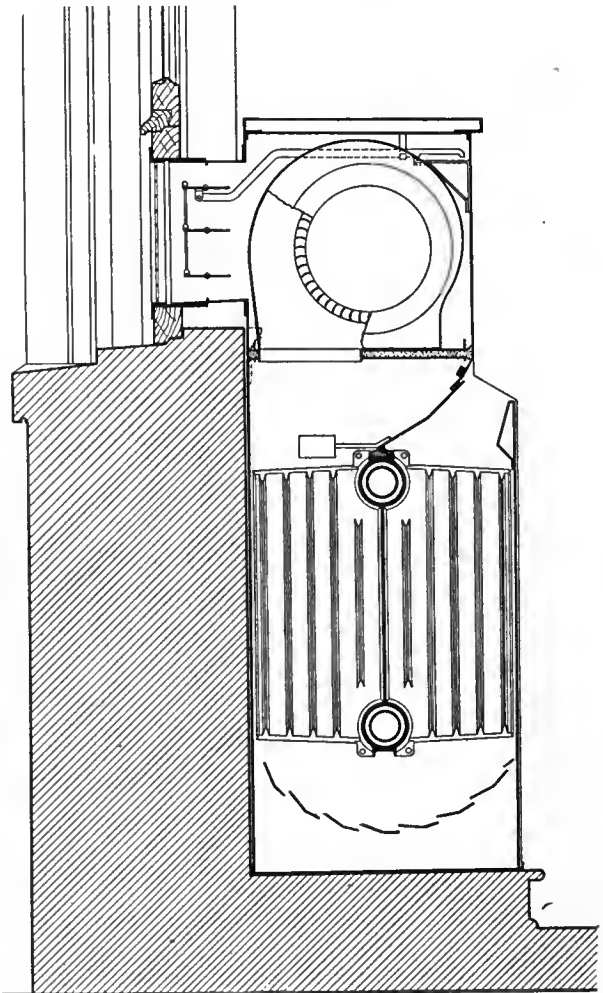

FIG. 12. TYPE OF UNIT HEATER SUITABLE FOR OFFICES, DRAFTING ROOMS AND SIMILAR OCCUPANCIES

admit a small amount in thin sheets at a comparatively high velocity along the ceiling for driving the steam toward the outlets. A false (hung) ceiling, with air space between it and the roof, is advisable in case of one-story buildings. A typical duct arrangement for a dye house is shown in Fig. 7. While the air should always be supplied by a fan, the discharge may be by gravity when the vent shafts can be carried to a sufficient height to produce the necessary draft. Otherwise an exhaust fan should be

air in winter causes dangerous drafts and excessive condensation. A typical layout for a laundry is shown in Fig. 8, in which the warm air and steam are removed through hoods placed directly over the machines where they are generated. In addition to these are a number of vents near the ceiling for general room ventilation, all of which, including the

hoods, connect with ducts leading to an exhaust fan. Fresh air, for replacing that discharged by the fan is admitted through "induction" heaters, which may be either steam coils or sectional cast iron radiators enclosed in galvanized iron casings so arranged that the air will come thoroughly in contact with the heating surface in passing through them.

The rooms are kept warm enough during the night to prevent freezing, either by special direct radiators or by providing dampers of such design that inside air may be re-circulated through the induction heaters when ventilation is not required. In the arrangement shown in Fig. 8 the induction heaters are designed simply for ventilating purposes and all heating is done by direct radiation.

LOFT BUILDINGS

Loft buildings are included in a class used principally for mercantile and light manufacturing purposes. The varied character of the work and more or less frequent changing of tenants makes it necessary to install a ventilating system of a semi-portable character rather than a permanent one as in case of a shop or factory. The heating is done by direct radiation, it being customary to place a radiator under each window so that partitions may be shifted at any time to suit tenants without interfering with the heating system. The ventilating scheme generally used is shown in Fig. 9 and consists of fan and heater, made up as a single unit and enclosed in a steel plate casing. This is usually hung from the ceiling so as not to infringe on the floor space. The fresh air is taken from the top of a window and warmed to 70 degrees, then distributed through a ceiling duct, as indicated in the cut. If the space is divided by partitions, then the branches from the main duct should be extended so as to reach each room requiring ventilation. Discharge ventilation is generally accomplished by leakage through windows, stairways, elevator wells, etc.

UNIT HEATERS

Unit heaters are one of the latest devices to be developed for the heating of industrial buildings and should receive brief mention in closing the present series of articles. A unit heater of this kind consists of motor, fan and heater mounted together as a single self-contained unit. Air is drawn in from the room, passed through the heater, and discharged at a fairly high velocity through specially formed outlets which diffuse it through a considerable space. This air movement produces a more comfortable condition for the workmen than when direct radiation is employed. When used in new buildings a sufficient number of these are installed to produce the required amount of heat, spacing them according to size and heating power. They are especially convenient for

additions where it is not practicable to extend the present heating system.

A typical heater for placing on the floor is shown in Fig. 10, and one for suspending from the ceiling in Fig. 11. An outfit of this type adapted to the heating and ventilation of offices and drafting rooms is illustrated in Fig. 12.

(The End.)

Flat Slab Floors

FLAT slab floor construction is fast replacing the beam and girder type of floor, and, generally speaking, has advantages in appearance and economy. However, there will be places where the beam and girder system will show a lower cost. Where panels between columns are square or nearly so, the flat slab usually works to advantage. When columns are spaced unequally or irregularly, it is often more economical to resort to the beam and girder type of floor. If the column spacings may be laid out with economy in view, the square bay and the flat slab will generally be selected. However, this selection should not always be made without a proper check by comparative cost estimates.

Assume, for instance, that a concrete storage building is required, the width of which may be anywhere from 55 to 65 feet and sufficient in length to give a certain specified area of floor space. The design is to be a flat slab system and the building is to be built as economically as possible. The engineer will usually make a design for a flat slab system with the columns spaced at distances he believes will show economical results. Two more flat slab designs should now be made with the column spacings one foot more and one foot less respectively. Comparative costs made on these three designs will show the economical standing of the various spacings for the specified live load.

It will be necessary to make typical cross-section designs showing the column spacings considered and then calculate the comparative costs of each design for a length of building equal to one bay. It is a simple matter to calculate the required length of the building for each type of cross section considered in order that the proper amount of floor space be obtained. The total length of the various buildings should be calculated to the nearest multiple of the length of their respective bays. This being done and the cost of one bay of each type of building being already calculated, the total approximate cost of each type of building is easily found. Adding to these respective estimates the cost of closing in the two extreme ends of the building, the engineer has a very good idea of the comparative costs of the designs he has made.—*Economy in the Design of Reinforced Concrete Buildings.*

How Wrought Iron Is Made

A Novel Campaign for the Education of Laymen. Moving Pictures of the Iron Industry

IN the past it has been customary to regard all galvanized sheet metal as galvanized iron because the old fashioned hand made sheet iron was formerly in great demand for these purposes.

Architects and builders now find it necessary to give special attention to the rust resisting qualities of the sheet metal which they specify for use in ventilating shafts, cornices, leaders and down spouts, tanks and other articles of a similar nature.

If the galvanized sheet metal used is galvanized steel and not galvanized iron, there will be great difference in the service of the product. When modern steel was made to replace the old-fashioned hand made iron it was found that the material did not give the service under certain conditions and its use became a real problem in modern building construction.

For many years metallurgists sought to find why steel would not stand up as well as did the old iron, in meeting the weather and climatic conditions. It was finally proved by these government scientists that the impurities which creep into the steel as made today set up an electrolytic action which cause the metal to pit, flake, and dis-integrate

in the presence of moisture. The problem then was for a pure iron that would resist rust. How to make this iron pure and at the same time make it in commercial quantities that would keep its price within reason was the big task taken over by the experts of the large steel companies.

Eventually a way was found for making pure ingot iron on a commercial scale that in every respect resembled the old-fashioned iron. In the years that have passed it has measured up to the claims for it in a manner to insure its use when greater permanency in sheet metal construction is desired.

Several views of various stages of the process are shown with this article. These pictures were taken in the plant of the American Rolling Mill Company, Middletown, Ohio. Recently this company has undertaken an educational campaign for the purpose of acquainting manufacturers, engineers and architects with the problems and processes in the manufacture of Armco ingot iron. The making of this iron is interestingly shown in moving pictures which have been made. The "movie" is soon to start on a tour of architectural and engineering societies, technical schools,

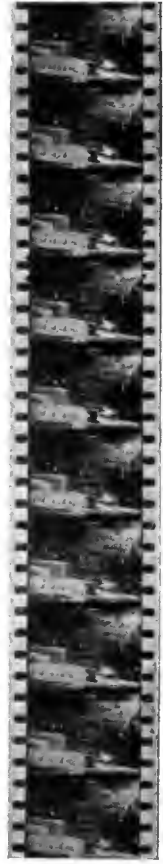

LIFTING HEATED INGOT FROM SOAKING PIT



POURING INGOT IRON INTO MOLDS



STRIPPING MOLDS FROM THE INGOTS

and sales conventions where the study of results in modern metallurgy is of paramount interest.

Comparatively few laymen have ever seen the sight of metal heated to 3000 degrees Fahrenheit. This temperature is necessary in the making of a pure iron. It is too hot in the vicinity of the boiling metal in the interior of the open hearth furnaces for the comfort of most visitors and the intense light from the mass is too blinding for the naked eye. Heretofore it was necessary to look through specially colored glasses at the iron when it was hot enough to flow like water.

When the "Armco" picture was proposed the movie concern was told it had an opportunity to make a record. They said that a close-up scene of boiling



ROLLING IRON INTO SHEETS

iron had never been made. And steel men said it could not be done.

Veteran steel workmen watched intently when the camera man set up his camera, wondering if he would stick it out or if the heat would crack the camera lens or set fire to the explosive film inside. The camera man himself was not sure, but there were two husky men back of him ready to jerk him out of the way in case anything happened.

The result was an entire success. This scene, together with the rest of the 3,000 feet of film is equivalent to a trip through a great steel and iron plant. The film will be shown in all parts of the world and the entire process, from the arrival of the iron ore at the blast furnaces to the final inspection of the finished products, is visualized.

The great value of wrought iron lies in its ability



LOADING SHEETS FOR ANNEALING

to resist corrosion. While steel gives entire satisfaction for structural shapes, such as I-beams, angles, etc., wrought iron has been found more practical for plain or corrugated sheets and metal lath. The use of wrought iron is almost universal in pipe where its non-corrosive qualities give long life and service.

In the puddling process of manufacture the molten iron is stirred continually until the carbon and other impurities are burned out, leaving the iron in a plastic condition and saturated with slag. The slag is squeezed out before the material is rolled into billets. The slag is present in alternate layers with iron and gives a fibrous structure. These layers of slag form a protective coating against corrosion and serve as a means of easy identification of wrought iron from steel.

Current News

Happenings and Comments in the Field of Architecture and the Allied Arts

Industrial Art at the Museum

The fifth exhibition of industrial art is now in progress at the Metropolitan Museum of Art. It will continue until Jan. 30. The object as heretofore is to show a selected group of objects of current manufacture, the designs of which are based upon sources in the museum. These pieces, brought together from factories and shops, cover a wide range of arts and craft goods, rugs, furniture, textiles, and many others. They serve both to reflect and to stimulate better standards among the layman, and are a further indication of the ever expanding influence of the museum on public taste.

Construction Division of U. S. A. to Hold Reunion

The annual reunion of those who were identified with the Construction Division of the army during the war will be held at the Morrison Hotel, Chicago, on February 25 and 26. The afternoon of the first day will be devoted to business sessions and the annual banquet will be held on the evening of February 26.

The membership of the Construction Division Association consists of those who served in the Construction Division of the army during the war, either in uniform or as civilians. The officers are: President, Col. Clark C. Wright, of George C. Nimmons & Co., 122 South Michigan avenue, Chicago; Vice-President, Col. J. N. Willcutt, of R. D. Willcutt & Sons Company, Boston, Mass.; Secretary George Gibbs, Jr., Washington, D. C.; Assistant Secretary, William Kennedy, office of Colonel Evan Shelby, 63 Wall street, New York City, and Treasurer, Major A. C. King, 8 South Dearborn street, Chicago, Ill. Colonel E. C. Stockdale, of Page & Hill, 19 South La Salle street, Chicago, is chairman of the Entertainment Committee.

Philadelphia Architects to Join in Building Exposition

In conjunction with the Philadelphia Real Estate Board's Real Estate and Building Exposition, which will be held at the First Regiment Armory during the week of March 28 to April 2, the T-Square Club and the Philadelphia Chapter of the American

Institute of Architects will hold an architectural exhibition, according to an announcement made by Mr. Philip N. Arnold, chairman of the Real Estate Board's Real Estate and Building Exposition committee.

Arrangements for an architectural exhibition are being made by the joint exhibition board of the T-Square Club and the Philadelphia Chapter of the American Institute of Architects, of which George Howe is chairman. This board, in addition to Mr. Howe, consists of R. J. Wadsworth, William C. Stenton, H. Bartol Register, Donald M. Kirkpatrick, Joseph P. Sims and Clarence C. Zantlinger. It is assisted by a special advisory committee consisting of Edward A. Crane, president of the Philadelphia Chapter of the American Institute of Architects; John P. B. Sinkler, city architect Nicola D'Ascenzo, Grant M. Simon, D. Knickerbacker Boyd and Emile G. Perrot.

In addition to the architects there will also be exhibits by the Atlantic City real estate board, the Camden real estate board, the North Philadelphia realty board, the Master Builders' Association and other similar organizations.

The co-operation of the architects, the trades and business organizations and a large list of manufacturers, merchants, material men and others, will make the exposition.

The architectural exhibition, which will be in complete charge of the joint exhibition board of the T-Square Club and the Philadelphia Chapter of the American Institute of Architects, promises to be the largest, most varied and most artistic ever seen in Philadelphia. In addition to holding their own exhibition, the joint exhibition board of the architects also will supervise the artistic features of the main exhibition.

Henry Reinhardt, Art Dealer, Dead

Henry Reinhardt, art dealer, head of Henry Reinhardt & Son, Fifth avenue, New York, died Jan. 13 after a short illness. He was 62 years old and began his art career in Milwaukee when still a youth. In the course of forty-five years he established galleries in New York, Chicago and Paris as well as in his native city.

Among his chief interests was the development of art appreciation in the West, and to this end he

helped organize several museums; notably the one at Toledo, for which he bought at auction for \$20,000 the now famous landscape "Moonlight," by the tragically fated Blakelock. It was Mr. Reinhardt, too, who arranged the loan exhibition of Blakelock's works to raise part of the fund for the painter's maintenance.

Mr. Reinhardt gathered what is said to be the finest collection of the works of George Inness, that which is now in the Art Institute of Chicago. During the war his Paris gallery was given over to the Red Cross for a medical library.

Civic Federation Will Discuss Labor Problems

Outstanding industrial problems, with which the American people are confronted today, from both the national and the international viewpoints, will be discussed at the twenty-first annual meeting of the National Civic Federation to be held at Hotel Astor, New York City, February 14, 15 and 16, 1921.

Kitchen Marathon Two Miles

Preparation of meals for an average family means a two-mile daily kitchen marathon for the housewife, statistics compiled for the conference of vocational workers of the South, in session at Montgomery, Ala., disclosed.

A pedometer attached to students in the kitchen of the model home in Livingstone School showed that measurement for stove-sink-and-pantry route covered during the preparation of the three daily meals.

Vast Forests in Northwest

More than 30,000,000 acres of commercial timber now stands in the private and national forests of Washington and Oregon, according to compilations of Thornton T. Munger, of the district forest service, Portland, recently received by Supervisor William G. Weigle, of the Snoqualmie national forest in Seattle.

What this vast stand of timber means to the Northwest as an economic asset was pointed out by Supervisor Weigle, who estimates that Washington alone cuts between 5,000,000,000 and 6,000,000,000 feet of timber annually. For every thousand feet of timber sawed and finished labor is paid \$16, or \$16,000,000 in wages for every billion feet.

Of the total area of standing commercial timber in both states, 15,047,000 acres is under private ownership and the remaining 15,428,000 acres under Federal control. This stand of merchantable timber represents 745,000,000,000 feet. The original forest area in both states was 48,000,000 acres, with 4,330,-

000 acres having been logged off and 7,500,000 acres destroyed by fire. The annual area being cut over at present is estimated at 260,000 acres.

Lumbermen Launch Campaign to Reduce Building Costs

A national campaign to reduce building costs was launched by lumber manufacturers from all sections of the country at a recent meeting in Chicago.

"Lumber has come down in price an average of 30 per cent.," said R. B. Goodman, of Marinette, Wis., chairman of the session. "The lumber industry has absorbed its wartime inflation and we feel that it is up to other building commodities to follow suit. Lumber represents only about 30 per cent. of the cost of the average building and not more than 35 per cent. of the cost of a wooden building."

France Plans Home for Married Women Only

A mothers' home, where women may have the necessary care that they themselves could not afford, is to be established in Bordeaux, France, with funds given by Madame Dutsch de la Muertha. It will be opened only to married women. Buildings, a park of 82 acres and \$200,000 were given for the work.

Brooklyn's Plymouth Church Rebuilding

The famous Plymouth Church of Brooklyn, N. Y., which suffered considerable damage from a fire last November, is now being repaired and restored by William Gompert, architect. The work will probably be completed in time for Easter services.

It was to this church that Henry Ward Beecher came as pastor in 1847. In the pulpit of Plymouth Church he acted as auctioneer one Sunday morning in Feb., 1860, and sold a slave girl into freedom. In this building, twenty-eight windows set forth the influence of Puritanism upon the liberties of the Republic. Rev. Newell Dwight Hillis, of international fame, is the present pastor. This is one of the structures that has helped to give Brooklyn a reputation as a city of churches.

Mr. Gompert stated that when the construction is completed the building will be modern in every respect, although it is the aim to retain the original lines and structures as far as possible in order not to interfere with old associations or to mar the sentiment of the old members.

Housing in Germany

In Cassell, a city of 170,000 population, 5,400 persons are without homes, according to the report of

the city housing commission, which is "rationing" rooming houses and hotels in an effort to shelter everybody during the winter months.

Because of the great shortage of houses, due to suspension of building operations during the war, it has been necessary to house large numbers sometimes in a single room. Regardless of ability to pay, the citizens now are compelled to occupy only such room as is absolutely essential and the extra space is apportioned among the homeless.

The "housing problem," while under the jurisdiction of a special commission, really is controlled by the police who keep a record of dwellings and the number of occupants and report their findings to the commission.

Owing to the high price of building material and the labor shortage, unrelieved in spite of the announcement that there is a large, undiminishing number of unemployed, building operations virtually are at a standstill.

Trying to Save Gobelins

Representatives of all the Austrian associations devoted to science and art have protested to Chancellor Mayr against the contemplated pledging of the priceless Gobelin tapestries owned by the Government as security for food supplies. It has been proposed that the tapestries be pledged for \$1,000,000 to secure two months' flour rations from the United States.

Steamboat service on the lakes of Upper Austria and in the Salzkammergut region of Upper Austria, Styria and Salzburg were recently suspended because of the excessive overhead expenses.

Rare Rembrandt Stolen

Rembrandt's landscape, "After the Thunderstorm," is stolen from a private owner in Hamburg, Germany. It supposedly was shipped to the United States on board the steamer Mongolia, which sailed the day after the theft.

The painting is on wood. It is sixty-five centimetres in length and forty-nine centimetres high. It is said to be valued at \$2,000,000.

For a Bureau of Housing

A bill proposing the creation of a Bureau of Building Construction and Housing in the Department of Commerce has been introduced by Senator Calder of New York on recommendation of the special committee which has been considering reconstruction problems, especially the nation-wide housing situation.

"The bill," said Senator Calder, "provides for a bureau in the Department of Commerce, which will be a clearing house for all information concerning

building construction matters and particularly housing. It is recommended by the leading architects and builders of the country, and it is believed that its operation will bring about a standardization of structural units and material and conservation in general building matters that will be most helpful in cheapening construction."

City Bureau to Plan Homes

In anticipation of a great home-building boom in the spring, the appointment of an architectural bureau is being urged in one of the larger cities according to the Concord (N. H.) Monitor.

It would be the duty of this bureau to consult with prospective builders in any locality and to give whatever aid and advice it could to insure a fine general appearance of the entire neighborhood; to see that building restrictions were complied with, and where former restrictions are not sufficient for present needs, to urge adaptations of plans so that adjacent property need not be harmed by cheapening structures.

Persons interested in establishing the bureau hold that five groups of people are to be considered when a new structure is contemplated. They are:

Those who live in the building.

Those who will live in the neighborhood of the building.

Those who invest their money in the building.

Those who have invested their money in the neighboring buildings or land.

All who see the building or are affected by it day by day.

A committee which co-operated to harmonize all these interests, even though its action be purely advisory, could, with the aid of public opinion, become a valuable adjunct to any community. Its counsel would help to make a city beautiful. Beauty is always a boost to real estate values as well as a source of civic pride, and many of the architectural blunders which result from innumerable individual operations might be avoided in making a harmonious whole.

Important Housing Conference

A housing conference will be held by the National Council of the Chamber of Commerce of the United States at the New Willard Hotel, Washington, January 27 and 28.

The Origin of "Checks"

A few centuries ago, when the ability to read and write was the exclusive property of a very few, the business men of Europe, many of whom could not even write the figures in which they dealt, employed a system of computation something on the principle

of the Chinese Abacus or counting frame. A checkerboard, it is learned, was placed between the two parties to the transaction and payment was made by matching one row of coins against another. In this way, even if the merchants were unable to count to a sum larger than ten, large transactions could be accurately negotiated by checking the coins, row after row, upon the checkerboard. From this practice accounts between business men came to be known as checks.

This was the origin of the name of the little pieces of paper which today are used, according to the estimate of bankers, in fully 90 per cent. of all business transactions.

News Notes in the Chicago Field

The Chicago city council rent committee is considering a plan for state legislation making residences and apartments public utilities and subject, therefore, to rate rulings of the public utilities commission. The plan was originally suggested by Dean John H. Wigmore of the Northwestern University.

The Bestwall Manufacturing Company, manufacturers of wall-board, is moving its Chicago offices to the main office at Buffalo, New York. The Chicago location was at 332 South Michigan avenue.

The so-called "building trust" inquiry is now going before a federal grand jury in Chicago. The probe relates to the alleged illegal arrangement between manufacturers, contractors and unions to forbid the use of non-union sash and door materials from other cities in Chicago construction.

B. J. Rosenthal, president of the Chicago Housing Association, estimates that 500,000 Chicagoans are poorly, some of them miserably housed.

Efforts to save the Fine Arts Building of the old World Fair group, because of its architectural beauty are not proving very successful. The Illinois Chapter of the American Institute of Architects is preparing an estimate as to the cost of putting the building into condition necessary to its preservation. In the meantime, the use of the building has been given to an American Legion post which proposes to use it as an inside rifle range.

The Woodworkers' Employers' Association has proposed to union carpenters that they accept a wage reduction of 85 cents an hour on the premise that it is better to work all week for 85 cents an hour than two days a week at \$1.10 an hour. The unions rejected the suggestion.

Personals

Arthur S. Millinowski and John F. Druar have become associated under the firm name of Druar & Milinowski, consulting engineers, St. Pual, Minn.

Guy A. Carpenter has opened an office for the practice of architecture in the Leggett Building, Fairfield, Ia.

P. J. Rocker, architect, formerly at 15 East 40th street, New York City, has moved his office to 6 East 46th street, that city.

Roger H. Bullard, architect, formerly connected with the firm, Goodwin, Bullard & Woosley, is now practicing on his own account at 15 West 33d street, New York City.

James V. Thetford, architect, formerly of 71 Bremona street, Belleville, N. J., is now practicing at 86 Malone avenue, that city.

Walter Williams, architect, is now located at 301 Fifth avenue, New York City. He was formerly at 420 Madison avenue.

Gregory B. Webb, architect, who was at 104 West 42d street, New York City, is now found at 1358 Broadway, that city.

A. J. Fisher, architect, has moved his office from 4011 North Robey street, Chicago, Ill., to 2001 Greenleaf avenue.

Tilden & Register, architects, have moved from the Franklin Bank Building, Philadelphia, Pa., to 1525 Locust street, that city.

Marchetti & D'Avino, architects, who were formerly located at 756 Main street, Hartford, Conn., are now practicing at Room 58, 721 Main street, Hartford.

Herman D. Roller, architect, has opened an office at 64 East Van Buren street, Chicago, Ill.

Reilly & Hall have moved from 749 Fifth avenue, New York, to 405 Lexington avenue, New York.

Morrell & Nichols, landscape architects and engineers, are now located at 1200 Second avenue, South, Minneapolis, Minn.

George M. Landsman, architect, has moved his office from the Bowery Bank Building, New York City, to 105 West 40th street, that city.

Weekly Review of the Construction Field

With Reports of Special Correspondents in Regional Centers

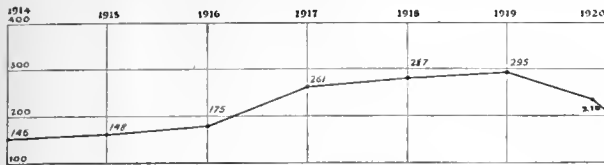

Average Prices, 1914-1920
(Note the Swift Decline)

A Study of Prices*

PART I

The Reasons Leading to Advance and What Is Necessary to Bring About Their Orderly Decline; the Manner in Which Prices Affect Credit Conditions

By

EDMUND D. FISHER
VICE-PRESIDENT
BANK OF DETROIT

Editor's Note: Prices are the problem of the day.

In our issue of January 19 we stated that an article on "The Architect's Relation to Price Declines" would appear in this issue. The article which follows is an authoritative discussion of the fundamental principles of price advances and declines. It is intended as a basic introduction to "The Architect's Relation to Price Declines," which will appear in an early issue.

AN old school rhetoric gives the following couplet as an example of figurative expression:

"The dashing waves with fury driven
Mount up and wash the face of Heaven."

During a storm at sea the power of the wind makes successive series of waves, the causes of which the observer is usually in no condition to analyze. It is only in the peaceful period that follows the storm that the thoughtful mind might study the subject of wave formation and develop a theory based upon the direct force of the wind in its relation to the reaction from the water, the bottom of the ocean, and the distant shore.

Similarly it is perhaps now possible, with the storm of war subsided and with the experience of a period of inflation and some measure of deflation, to analyze the causes which make the successive waves of price movement which characterize our economic life. It may also be possible to develop some principles of action to stabilize our governmental and business relations in the period of deflation before us.

In studying price relations in order to make the analysis as simple as possible, it may be well to emphasize in advance that, as in the formation of the waves of the ocean, there is a single initial force, the varying power of the wind; so in the price

changes of our business life there is also a single initial force, the varying spending power of governments and the people. It will be necessary, therefore, to consider the direct changes in the amount of money and credit used as spending power in relation to a given volume of commodities, and the relative amount so used when the volume of commodities change.

Reference is frequently made to two forces affecting prices—one the buying power (demand), dependent upon the supply of actual money, bank deposits, or the latent power of credit supporting the purchaser; the other the selling power (supply), dependent upon the volume of commodities or the amount of service to be sold. Both of these tendencies are, of course, affected by a temporary indisposition to either buy or sell at a given level of prices, as we well know from present conditions.

But as price grows out of a definite relation to the standard of value (gold), it should be considered as the result of a spending power which increases or diminishes directly (increase or decrease of money or credit), or relatively (increase or decrease of commodities), to the volume of trade. Thus, although the standard remains fixed, the value of the dollar in actual use increases or diminishes in relation to its own volume used as a spending power.

The principle to be established, therefore, is that the average level of prices is determined by the amount of money available as spending power. This is effected by the amount of gold in reserve, the volume of credit or currency which the gold supports, and the actual amount of money in the hands of the people. The greater the volume of money or credit, the higher will be the price level, production being relatively the same.

On the other hand, assuming production relatively the same, the reverse is also true—the weaker the spending power, as when money is hoarded or when loans are called or paid, the lower will be the price level. The operation of the principle to which reference has been made is easily lost sight of in the history of business experience, because, although spending power is the dominant factor, it is frequently confused with what are seemingly new conditions, such as war and the variations in production and selling power.

THE entire subject may, perhaps, be better understood by a study of the following analysis:

*Copyrighted 1920 by Edmund B. Fisher.

THE AMERICAN ARCHITECT

COMMODITIES	INFLATION MONEY	PRICES
Stated volume of commodities at prices then fixed	If money or credit increases	Prices go up
Reduced volume of commodities	Amount of money or credit then relatively increases	Prices go up
Increased demand reducing commodities	Amount of money or credit then relatively increases.	Prices go up

During such a movement as the foregoing, as prices go up, the amount of credit and currency also directly, as well as relatively, increases, made necessary by the growing dollar amount of goods to be moved, until restrained by diminishing gold reserves or bank policy, impelled by increasing rediscount rates.

COMMODITIES	DEFLATION MONEY	PRICES
Stated volume of commodities at prices then fixed	If money or credit decreases	Prices go off
Increased volume of commodities	Amount of money or credit then relatively decreases	Prices go off
Reduced demand, relatively increasing commodities	Amount of money or credit then relatively decreases	Prices go off

During such a movement, as prices go off, the amount of credit and currency, directly as well as relatively, decreases, made possible by the lessening dollar amount of goods to be moved, until stimulated by increased gold reserves and a more liberal bank policy, impelled by lowering rediscount rates.

A PERIOD of inflation and deflation may be pictured as a definite wave of price movement; but like the ocean, there are short waves and long waves. The price waves range from the movements that grow out of the day to day fluctuations of the market to the long "ground swell" that seems to us extends over a long period of years. These movements are all operating constantly, are complexly interrelated, and grow out of the variations of spending power with the reactions from variations in production and demand. A disintegration of these movements, however, would seem to develop a fairly comprehensive classification, eliminating all temporary and superficial day to day price changes.

PRICE CHANGES

Seasonal Movement: Reactions from seasonal variations in production and demand.
Annual Movement: Reactions from variations in annual production.
Credit Movement: Direct result of varying amounts of bank credit and currency.
Gold Movement: Direct result of variations of world gold production.

Seasonal variations in prices are, of course, familiar to the business and buying world. Business men are also vitally interested in the statistics of annual production, as the increase or decrease of the principal crops in the reaction on spending power frequently makes important, though temporary price changes.

The credit movement is a short period swing in prices. Without direct relation to the increase or decrease of gold, a spending power develops and recedes through the expansion and contraction of credit and currency. Beginning at a period when bank reserves are high and money is "easy," a growing business activity in all lines fosters a growth of loans made on both a sound and unsound economic basis. While individual loans made in such a period of expansion may be perfectly good from the standpoint of ultimate payment, the composite influence of many loans that are not self-liquidating, such as mortgages, loans on stocks and bonds, and government securities, merely adds to the spending power of the period and directly operates to increase prices. The higher level of prices thus established necessarily increases the dollar volume needed to conduct future trade, and so an endless chain of increased loans and higher prices is established. The emergency brake is finally jammed on, and the financial gears thrown into reverse, and there occurs the liquidation of loans and the reduction of currency, with the consequent diminishment of spending power.

The gold movement, a long swing period in prices, is usually very sluggish, and is characterized by the basic variations in spending power caused by the economic effect of variations in gold production. As gold is the basis of bank reserves and currency issues, its gradual change in volume has an ultimate under-current effect upon all price movements.

(To be continued.)

(Special Correspondence to AMERICAN ARCHITECT)

SEATTLE.—Jobbers of the Pacific Coast territory report that the outside steel mills have horizontally met the Corporation price and are trying to convince the retail and investment construction trade that rock-bottom has been struck for the season and that a delay in placements beyond May 1 will mean higher prices for them. Stocks on hand are now well balanced. The overstock is sufficient

THE AMERICAN ARCHITECT

to meet any sudden movement in early spring months.

The feeling toward building for 1921 is changing rapidly. Optimism has replaced the pessimism of December, and there is increasing evidence of confidence among investors and builders. Architects report that builders are now convinced that the "holding off" policy for lower prices is now futile. Building labor is producing at normal per capita, new projects are slowly being released, the lumber market has undoubtedly struck bottom (as shown in the stationary bottom for the past two weeks), mills are resuming operations, and labor costs have been reduced.

Wholesale and jobbing interests are co-operating in the tail-end liquidation, now believed to be well over. Minor reductions in building hardware during the week are putting the finishing touches on the orderly process. Larger operators believe steel will sustain itself, in view of demand and fair gross margins instituted by the mills after the war.

Representatives of eastern roofing who sent out flunkies with order books during the war to look over the territory and book orders merely because the demand far exceeded the supply are to come in for castigation by jobbers. The houses which took unfair advantage during the war are in process of elimination from the territory.

Roofing prices are now on the past four months' levels. There is an oversupply, and liberal offerings. Three cement plants are now in full operation after two had been closed wholly or in part for six months. One attended to the export production, one closed entirely, and the third was on half time. This represents the total cement production, normally heavy, in the North Pacific territory.

Average prices received at the fir mills during the week at the mill were \$59 to \$54 for vertical grain flooring, \$29 for No. 2 slash grain flooring, \$51 for finish, \$25 to \$28 for ceiling, \$31 for drop siding, \$15 to \$20 for boards and shiplap based on sizes, \$23.50 to \$14.50 for dimension, \$19.50 to \$21.50 for plank and small timbers, and 26 for big timbers. The fir log market declined this week from \$18, \$24 and \$32 to \$12, \$14 and \$20, and wages in the fir mills and logging camps are down 25 per cent., with no remonstrance from the men due to the unemployment situation.

Red cedar shingles are steady on a speculative rather than an order basis, and stocks on hand in British Columbia, Washington and Oregon, the scene of production, are under normal at 500,000,000 shingles, exclusive of transits and held for disposal at reconsigning points. Manufacturers are refusing to sell on the present price to the trade of \$1.85 to \$1.95 for stars and \$2.00 to \$2.10 for clears, 20-20

or "square" pack basis, which has superseded the old per 1,000 basis.

Seattle's building record for 1920 fell little short of that of 1919 according to the figures of the city building department. With the issuance of the permit for the 10-story Class A structure now in the last steel stages by the Pacific Telephone and Telegraph Company the total for the year was brought up to \$13,500,000, as against \$15,000,000 for 1919.

The contract for construction of the nurses' building at the Puget Sound navy yard, Bremerton (17 miles from Seattle), was let to Swenson & Co., contractors, of Seattle.

(Special Correspondence to AMERICAN ARCHITECT)

CHICAGO.—The building public here is indulging in a "buyers' strike" and is waiting for the actual materialization of the now famous rock-bottom basis. The endless circle of cause and effect—lumbermen blaming materials men, materials men blaming labor, and labor blaming the high cost of living—is blocking building here for a while, at least. When this is disposed of, and actual materialization of rock-bottom prices comes into existence, there is no doubt that building will go forward in Chicago in a manner never before witnessed.

The principal hope for this stabilization of the condition lies in the conference of all the varied industries in the building trades, which will take place here January 21-22 and in which keen interest is shown on every hand. President-elect Harding has written John H. Kirby, president of the National Lumber Manufacturers' Association, recalling the recent visit made to him by officials of the association and expressing the hope that the conference will result in a plan which will serve to revive building and lessen unemployment. Mr. Harding also points out that this conference may very well inspire other lines of industry to do likewise.

Labor is contributing its share to readjustment a trifle more readily than in the past. Far-seeing labor leaders are encouraging labor leaders to bear some of the shock of the readjustment period. Unemployment is unconsciously helping in this, but there is distinctly a tendency toward more active participation, a "day's work for a day's pay" now coming more generally into favor. Wages remain upon about the same levels, though longer working days are announced by several firms, notably the Pullman Company, the nine-hour schedule having been established in some of the construction departments, over the protest of the employes. This affects two thousand men in Chicago, and possibly some in the Pullman works in Buffalo and Wilmington, Delaware.

Unemployment here has been exaggerated by va-

THE AMERICAN ARCHITECT

rious sources, some putting the number of unemployment at 200,000. But George H. Burns, in charge of the Chicago District of the Department of Labor, maintains that his figures show about 90,000 men out of work in this district.

Excellent progress is reported in connection with the new union station. It is intended now to complete the building in two years. The completed building, trackage and the like will cost about \$60,000,000.

The Wrigley building, which for a time at least is to be Chicago's most conspicuous office building, is now almost ready for tenants.

Plans are under way for a new \$1,500,000 building in the so-called "Link District," which is an extension of Upper Michigan Avenue. The building will be twelve stories, at Erie Street and Michigan Avenue, will contain shops of the smarter sort on the ground floor, and will be one of the units designed to cause New Yorkers to grow green with envy when they contemplate the beauties of the upper reaches of aristocratic Michigan Boulevard.

Chicago is to have a million-dollar temple to Bahai, if present plans mature. It will be an architectural novelty, situated on an eight-acre tract in Wilmette, an exclusive North Shore suburb, will be 160 feet high, with a round base 160 feet in diameter. There will be nine sides, with a door in each side, typifying the doors by which the devotees of the nine principal faiths may enter the temple and the faith of Bahai. Henry J. Burth, of Holabird & Roche, architects, is structural engineer for the temple. Application has been made for a building permit.

Costs of lumber and other building materials have undergone no recent change of importance. Present Chicago quotations are:

Yellow Pine: B. & B. 1-in., \$95 to \$130, depending on thickness; 2 x 4, No. 1, 10 to 16 ft. length, \$51 to \$53; 2 x 6, \$48; 2 x 8, \$50; 2 x 10, \$53; 2 x 12, \$55; 13-16 x 3¼ z & b flat flooring, \$85 to \$90; 1 x 6, No. 2 common, \$48 to \$90. *Douglas Fir:* 2 4 S, in sizes up to 12 x 12, in length up to 32 ft., \$65 to \$70; 14 x 14, \$68 to \$73; 16 x 16, \$72 to \$75; 18 x 18, \$75 to \$80. *Hard Maple:* Four, ¼ No. 1 and 2, \$135; select, \$120; No. 1 common, \$100; No. 2 common, \$65; No. 3 common, \$32. *Birch:* Four ¼ No. 1 and 2, \$160; select, \$133 to \$138; No. 1 common, \$95 to \$100; No. 2 common, \$60 to \$65; No. 3 common, \$40. *Red Gum:* Four

¼ No. 1 and 2, \$150; No. 1 common, \$90 to \$92; No. 2 common, \$45.

Face Brick—Standard, vitrified red, \$32.00@34.00; Smooth, Indiana red, \$38.00@40.00; Smooth Ohio red, \$38.00@40.00; Smooth, Pennsylvania red, \$46.00@48.00; Smooth, buff, \$45.00@47.00; Smooth, gray, \$47.00@49.00; Rough, buff, \$44.00@46.00; Rough, gray, \$47.00@49.00; Variegated, rough texture, \$34.00@49.00.

Common brick, \$16.00 per M. Portland cement, \$3.00 per bbl. Torpedo—Lake and bank sand, \$3.50 per yd. Crushed stone, gravel screenings, \$3.50 per yd. Hydrated lime, Ohio, paper, \$22.00 per ton. Hydrated lime, Ohio, cloth, \$29.00 per ton. (Includes sacks at 30c. each.) Hydrated lime, Wis. paper, \$20.00 per ton. Bulk lime, \$1.75 per ton.

(Special Correspondence to AMERICAN ARCHITECT)

BOSTON.—The optimistic tone noted at the beginning of the new year was justified in a great many instances, but there is still much ground to be recovered.

The opening of many of the larger textile mills, a better sentiment in the woolen market in Boston, a return of confidence in the shoe and leather industries, all point to better things. Shoe sales amounting to \$10,000,000 during the recent National Shoe Retailers' Association in Milwaukee indicate the beginning of the end of the so-called "retailers' strike" which curtailed buying for a long period.

One cloud in the bright building outlook in New England loomed up recently, when the United Building Trades Council of Boston, representing about 30,000 building mechanics, voted to reject the proposed 90-cent per hour agreement offered by the Building Trades Employers' Association, a cut of ten cents an hour from the old agreement. Contractors interviewed by your correspondent see little to worry about in the situation, considering the move ill-timed just now, when there exists a large excess of workers, due to scarcity of building projects. General opinion looks for a satisfactory settlement of the matter before spring building starts.

Your correspondent finds that contracts awarded for the week ending January 11 would appear to indicate a typical situation. For 1920, for that week, contracts awarded amounted to \$2,175,000 as compared to \$5,145,000 for the corresponding period in 1920; \$722,000 for 1919; \$2,602,000 for 1918; \$2,048,000 for 1917, and \$3,248,000 for 1916.

frontispiece to No. 254

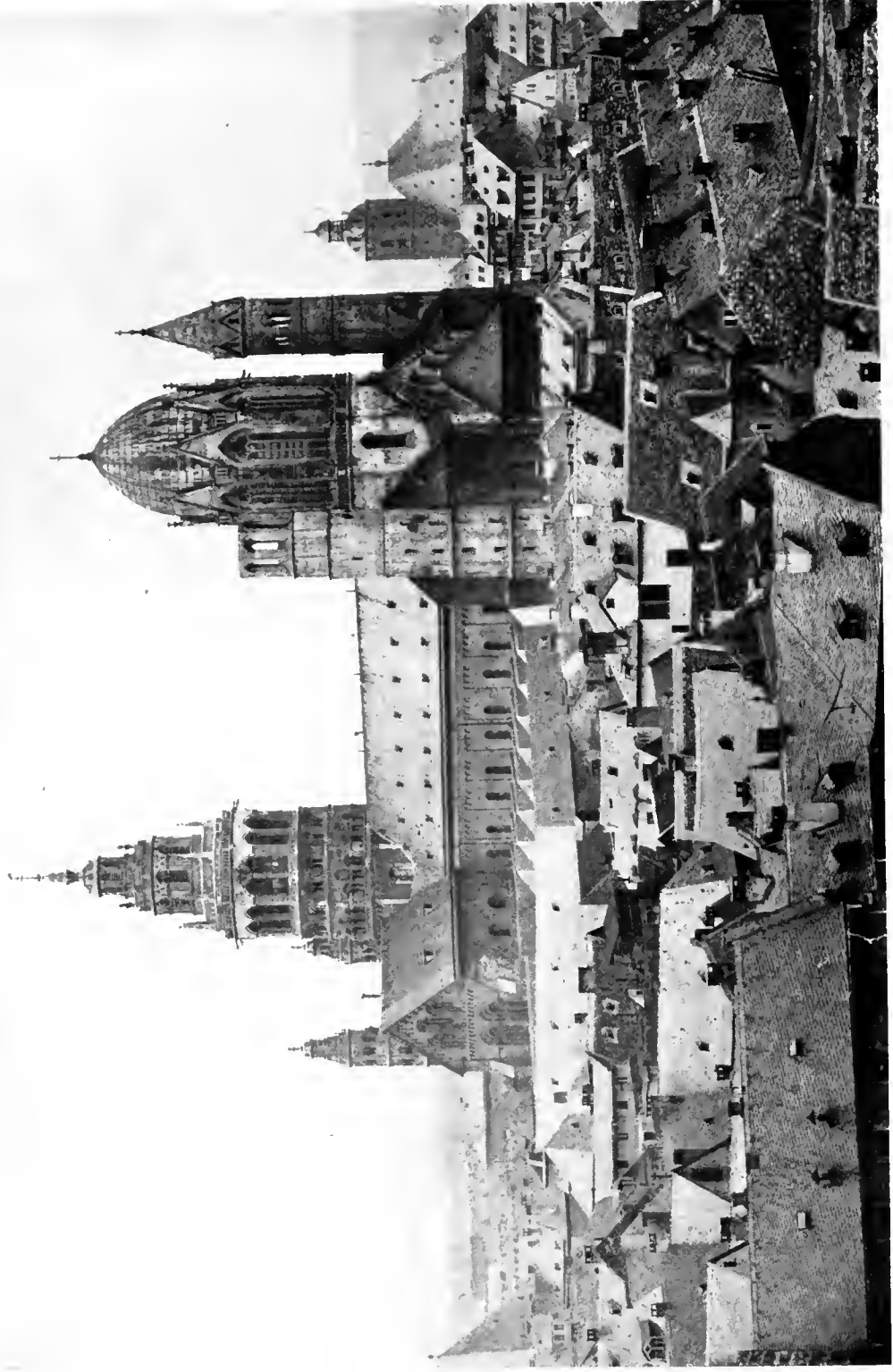

THE CATHEDRAL, MAINZ, GERMANY

THE AMERICAN ARCHITECT

VOL. CXIX

WEDNESDAY, FEBRUARY 2, 1921

NUMBER 2354



SHERBOURNE HOUSE CLUB
ROBERT SIMPSON COMPANY, LTD., TORONTO, CANADA
N. MAX DUNNING, ARCHITECT

The Work of N. Max Dunning

THE practice of architecture is of two classes considered as to its location. One may have his work confined to one locality, another may have his work widely distributed throughout the country. In the former case fellow architects and the public are familiar with his work and his position is well defined; in the latter this condition may not exist and then it is by assemblage that study and appraisal is possible. It is in this latter class that the work of N. Max Dunning, F. A. I. A., is placed, as his work is widely distributed, literally from Halifax to Los Angeles. Here are illustrated several examples of Mr. Dunning's work, indicating its scope and character.

The great mail-order corporations in America are but few in number. The two largest in the United States have their headquarters in Chicago and practically all of their buildings, including numerous large branch plants, have been designed by architects. The buildings of the great Canadian mail-order house, The Robert Simpson Company, Ltd., have been designed by Mr. Dunning. The main plant, located at Toronto, is characteristic of the branch houses located at Regina and Halifax. The

Toronto building is eleven stories and basement in height and of sufficient ground area to present an imposing appearance. The greater portion of the wall surface is entirely composed of glass, excepting the spandrels. This scheme always presents a difficult problem for architectural treatment. The main exposed exterior structural members are made of concrete with brick paneled spandrels.

At each end of the principal elevation is a three bay pavilion, the center bay projecting. The vertical members are heavy and of substantial proportions, with an attendant reduction of the glass areas, provision for shadow effects, concentration of ornamentation and emphasized cornice. The three principal divisions of the elevation are well balanced, the extremely plain central area is relieved by the more pronounced end pavilions and withal a simplicity of designing which satisfies. The five story building at Halifax is designed with the same central portion of glass excepting the spandrels. In the Regina building, one half of which has been constructed, all of the vertical structural members are exposed. The corner pavilions are designed with great simplicity and effectiveness. This building of-

fers an excellent opportunity to compare the effect of the exposed vertical structural members with the buildings in which these members are behind the windows.

In connection with the Toronto project a dormitory building was erected to house the female employees of The Robert Simpson Company, Ltd., and the surplus accommodations allotted to art and other students. It is quite an extensive building but the funds available limited its design to service only and with little attempt to secure exterior architectural effect. The dormitory was constructed at the rear of extensive grounds surrounding an old mansion on Sherhourai Street. The residence was remodelled

cers are located on the first floor, the general offices on the second floor and in the basement are the multigraphing, stationary, mailing, filing and exhibit rooms. In addition there is a men's and women's lunch room with kitchenette, a nurse's, examination and quiet rooms for the social service department; barber shop, shower baths, boiler and fan rooms; large vaults are provided on each floor.

The Stromberg Motor Device Building, Chicago, has a special roof construction over the sixth story which is used as a brass foundry. A description of this roof was published in THE AMERICAN ARCHITECT, Sept. 1, 1920, page 291.

To adapt a plan to an irregular shaped area is al-

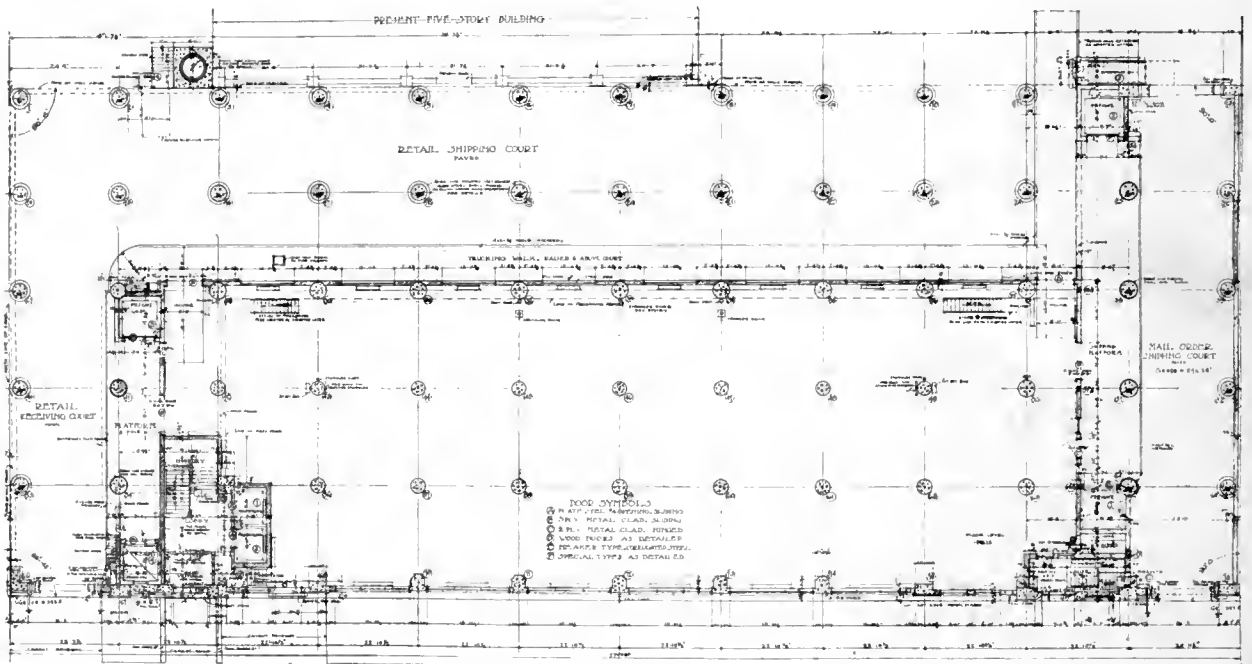

FIRST FLOOR PLAN
 BUILDING FOR ROBERT SIMPSON CO., LTD., TORONTO, CANADA
 N. MAX DUNNING, ARCHITECT

and with the extensions provides the occupants of the dormitory with reception rooms, club rooms and grounds, comprising a most satisfactory plant.

The buildings of the National Cloak and Suit Company at Kansas City, Mo., are designed along similar lines. The plant is being constructed in sections with detached power house. Ample ground space permits the arrangement of complete railroad and vehicular transportation service. The office building for the Simmons Manufacturing Company at Kenosha, Wis., is a good example of the modern detached office building of a large manufacturing company. The private offices of the executive offi-

ways an interesting problem, especially when the floors are divided for different purposes. The Hotel Winton faces two streets which are not parallel and an adjoining property cuts out a corner on the rear. Being located on inside lots it was necessary to use three courts to provide light to guest rooms. The typical floor plan shows a large number of rooms equally well lighted. The public rooms are in the basement, first and mezzanine floors. The power plant and laundry are located in an adjoining building. The lobby, lounge and various dining rooms are large, well proportioned and very conveniently arranged. The decorative details are generally in

THE AMERICAN ARCHITECT

low relief and simple. The colors applied and the woods and marbles used are quiet in tone and very harmonious. The principal elevation is of a red brick and light colored terra cotta. There are no extreme projections in any of the parts and the satisfactory impression produced is due to the disposition of the well proportioned openings and the well placed horizontal members.

The Bethany Bible School is designed to be a complete institution in which there are provided dormitories, lecture halls and a chapel. The buildings are arranged about a city block with a large quadrangle in the center. These buildings were erected during



BUILDING FOR ROBERT SIMPSON CO., LTD.,
MUTUAL STREET, TORONTO, CANADA

N. MAX DUNNING, ARCHITECT

a period of years and are of sufficiently varied design to present an interesting appearance.

The building of the American Book Company, Chicago, is a very substantial and well proportioned structure. The offices are located in the top story and the balance of the building used for the storage of books, shipping and receiving departments. The exterior is faced with a rough faced red brick combined with very simple and effective terra cotta sills, caps and belt courses. The designing is simple, slight projections of the vertical members, the heavy projections of the belt courses and deep window reveals provide excellent shadow effects. The treat-

ment of the first and fifth stories provides the needed additional surface effects. In the tower are placed the sprinkler and house service tanks.

Among other buildings designed by Mr. Dunning



BUILDING FOR ROBERT SIMPSON CO., LTD.,
HALIFAX, NOVA SCOTIA

N. MAX DUNNING, ARCHITECT

are the Dixon National Bank and the Dixon Home Telephone Company buildings at Dixon, Ill.; the Kenosha Hospital and the Newell Memorial Chapel at Kenosha, Wis.; the Fourteenth Church of Christ, Scientist, and the Oak Park Baptist Church, designed in association with C. A. Jensen and E. E.



BUILDING FOR ROBERT SIMPSON CO., LTD.,
REGINA, SASKATCHEWAN. VIEW TAKEN
DURING CONSTRUCTION

N. MAX DUNNING, ARCHITECT

Roberts, respectively. Of the residences designed by Mr. Dunning, that of Mr. Robert J. Thorne at Lake Forest, Ill., is the most important. This was designed in association with John W. McKecknie

THE AMERICAN ARCHITECT



BUILDING FOR
NATIONAL CLOAK AND
SUIT COMPANY
KANSAS CITY, MO.

N. MAX DUNNING,
ARCHITECT

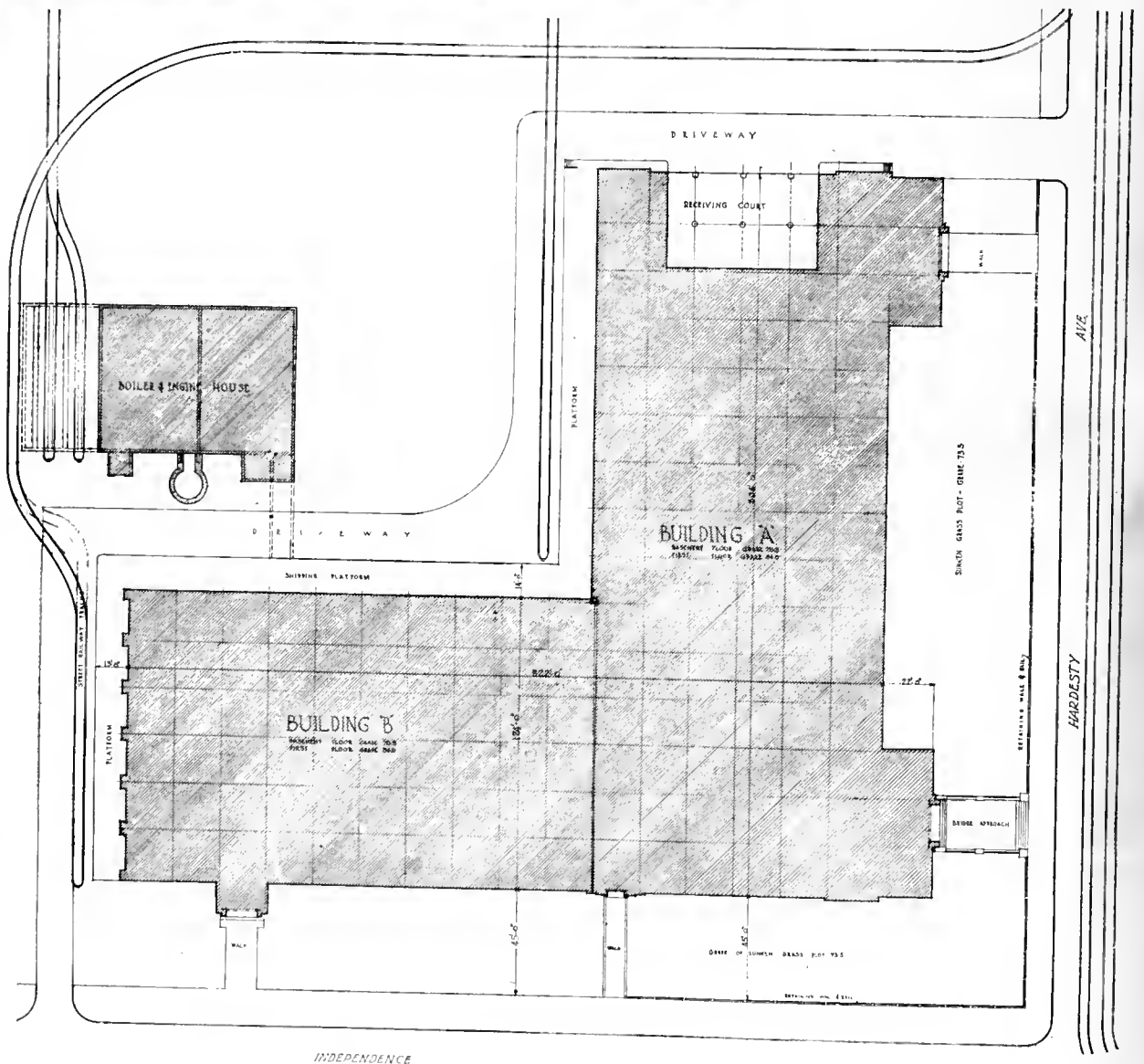

PLOT PLAN

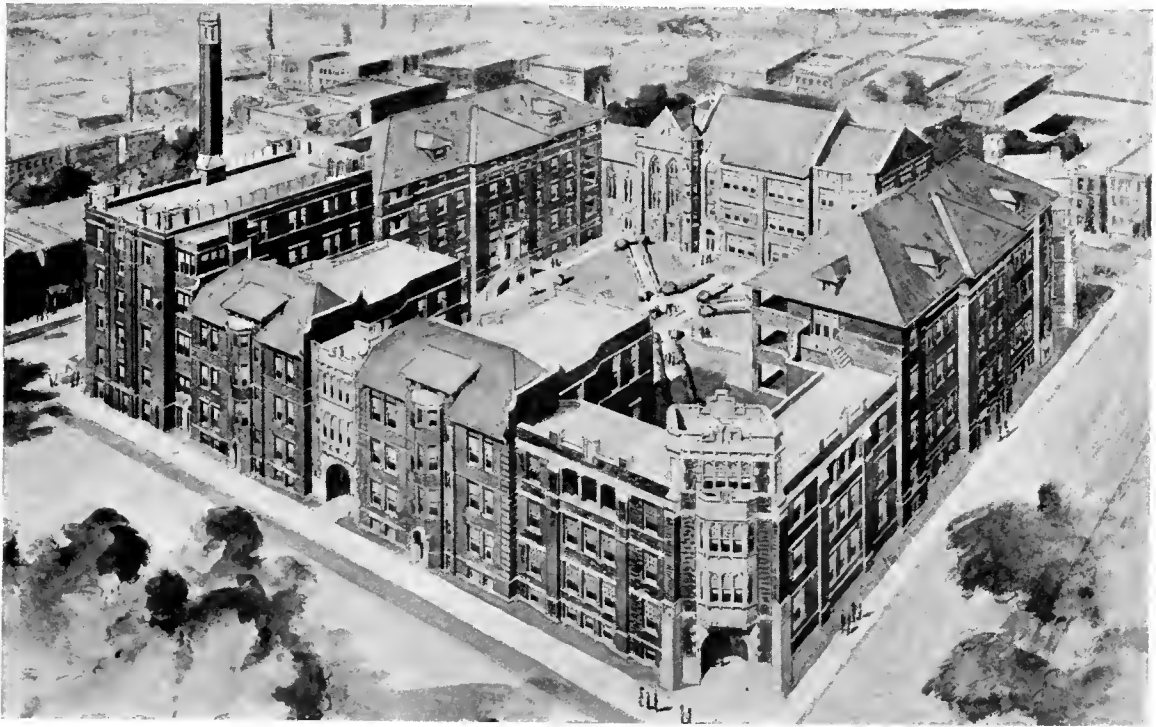

BIRD'S-EYE VIEW

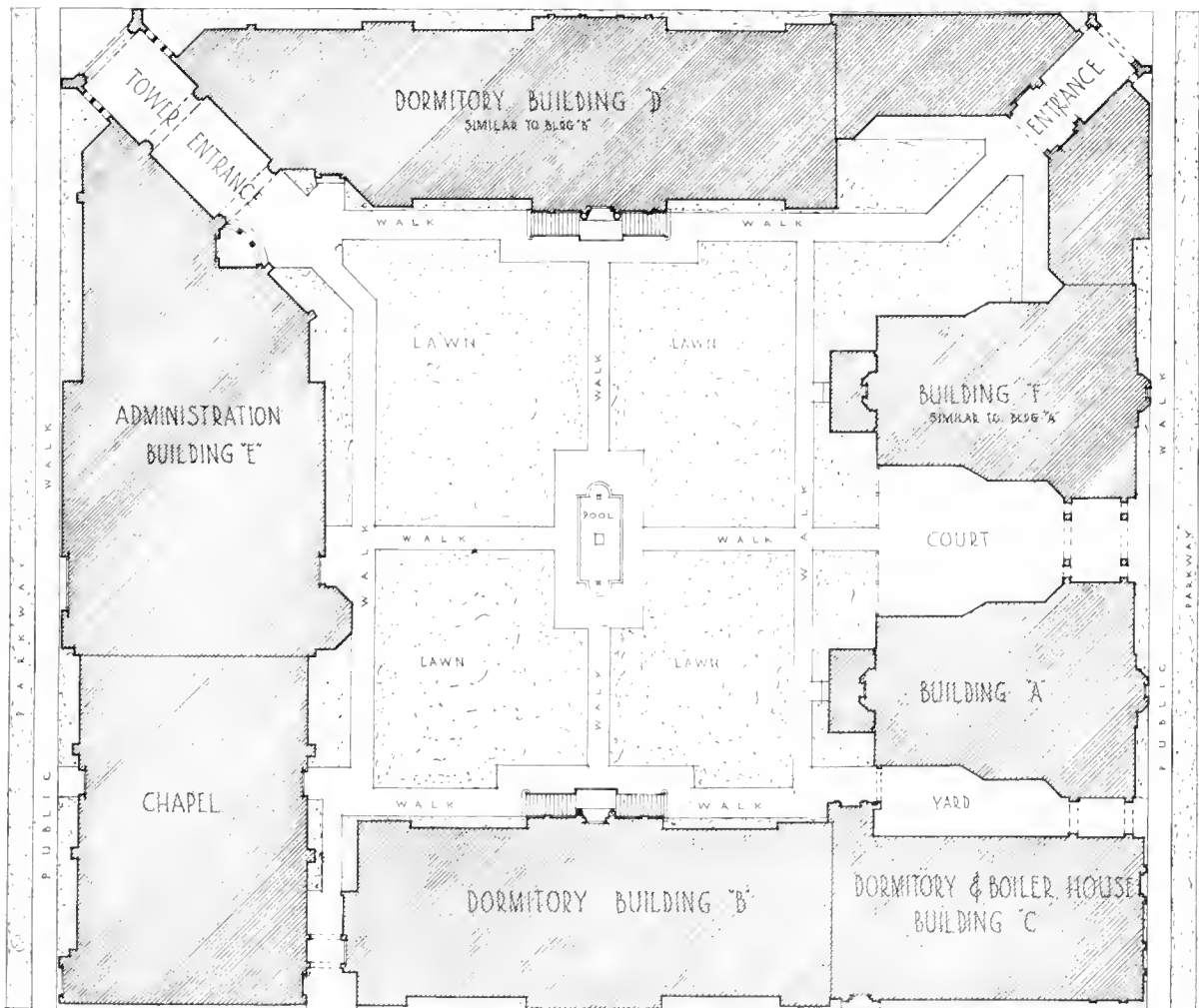

PLOT PLAN

BUILDINGS FOR THE BETHANY BIBLE SCHOOL, CHICAGO.

X. MAX DUNNING, ARCHITECT

of Kansas City. These it is proposed to illustrate in succeeding issues.

It is apparent that the basis of Mr. Dunning's designs is a careful study of the elementary requirements of the project. On these is erected the design in a simple and logical manner, with careful

consideration being given to the materials employed. There is no striving for effects not consistent with the requirements of the building, neither is there evidence of adaptations from other works. Simplicity, charm and dignity characterize the work as they are characteristic of the designer.



OFFICE BUILDING FOR SIMMONS MANUFACTURING COMPANY, KENOSHA, WIS.
N. MAX DUNNING, ARCHITECT

Architectural Registration Matters

HAVING received from E. I. Du Pont De Nemours & Co., Inc., of Wilmington, Del., certain inquiries as to the various states in which there are registration laws or other legislation controlling the practice of architecture, we referred the letter to the secretary of the National Council of Architectural Registration Boards.

The reply to this letter was so thoroughly prepared that we are presenting it herewith in the belief that it will be of wide interest:

"Gentlemen:

"Your letter of December 16, 1920, addressed to the Architectural & Building Press, Inc., 243 W. 39th street, New York City, has been referred to me for reply by Mr. W. H. Crocker, editor of THE AMERICAN ARCHITECT.

"A list of the states having laws regulating the practice of architecture is regularly published in the *Journal* of the American Institute of Architects, see latest list, December, 1920, page VII. The requirements of the laws in the different states vary greatly. A digest of these laws would involve labor so extensive, that I am sure that you would not expect anyone to furnish you with such information without adequate remuneration.

"On November 18 and 19 there was held in St. Louis, Missouri, a meeting of the registration officers of the various states having registration laws. And there were in attendance at this meeting representatives from seventeen states out of the twenty having registration laws. And there were also present representatives from a considerable number of states which have laws pending in their respective legisla-

tures. As a result of this conference, which lasted two days, the meeting unanimously resolved to form a National Council of Architectural Registration Boards, which, among other duties, should act as a clearing house for information regarding architects who might desire reciprocal transfer from one state to another.

"I am enclosing copy of Constitution and By-Laws of this organization, and beg to say that the organization will be completed and ready to function on or about the second of January, 1921. This organization will be able to offer a great convenience to architects doing interstate business. Of course, as it is purely a voluntary organization, and no state board can surrender its function under the various state laws, it must depend for its value largely upon the spirit of co-operation, which was manifest in the council meeting held in St. Louis.

"One may be entitled to practice architecture under the registration laws in a particular state and not entitled to transfer to another state, due to the stringent requirements of the laws in the state to which the architect desires transfer. To eliminate this difficulty and avoid taking a number of examinations, the council proposes to issue a standard N. C. A. R. examination, which when one has taken will be deemed sufficient evidence of competency to entitle that person to registration in any state in the United States; due to the fact that the standard N. C. A. R. examination questions will require the candidate to pass an examination at least equivalent to the requirements of every state in the United States. I would strongly recommend every architect who expects to engage in interstate business to prepare and take the standard N. C. A. R. examination.

"It is expected that these examinations will be given by the state examining committee in the state where the man resides or in the state nearest to his residence. But the questions will be prepared by the National Council. The procedure will be about as follows:

"The applicant for a standard N. C. A. R. examination will file a fee of twenty-five dollars and apply to the National Council of Architectural Registration Boards for a standard N. C. A. R. examination, and will designate the state nearest his residence where he wishes to be examined. The council will then investigate the examination requirements of that particular state and prepare additional questions to cover the requirements of other states in addition to the requirements of that state, make an investigation of the applicant's record in practice, certify to same and turn over to the officials where the applicant wishes to be examined. The applicant will then file an application for examination in the state where he wishes to be examined, stating that he wishes to take a N. C. A. R. standard examination.

He will then appear before the local state committee and take the regular state examination and the additional N. C. A. R. examination; and if successful in the examination, the local state examining committee will certify that he has passed the state examination, also the standard N. C. A. R. requirements.

"A certificate of this kind and an application from the National Council of Architectural Registration Boards will entitle the applicant to registration in any state in the United States upon the payment of fees without appearing or examination, provided he keeps his record clear as to honesty, integrity and discreet caution in practice. Thus a competent architect may dispose once for all of examination requirements. Should an architect not wish to take the standard N. C. A. R. examination, but wish to be transferred from one state of registration to another state of registration, his procedure would be about as follows:

"He would apply to the National Council of Architectural Registration Boards for an application blank and pay a fee of fifteen dollars, fill out this application blank and return to the National Council. The council would then carefully investigate his record of practice in the state where he resides or in any other state where he is registered to practice. This would include correspondence with his clients, the local architectural societies, fellow architects and a transcript of his record with his own state examining committee. This material, carefully collected, collated and certified to, would be transferred by the council to the registration officials of the state where he wishes to enter practice and would be used by the examining committee of that state as evidence to determine his eligibility for registration in that state. If his previous examination was equal in standard to the state where he wished to be transferred and his record in practice without blemish, he would in all probability be granted a certificate showing his right to practice architecture in the state receiving the report of the council. And would thus be saved the time, expense and delay of a personal appearance at an examination in the state in question. Should he fail in the examination in question and so desire, the council would refund his application fee. Should he wish to be transferred to still another state, he should file an application for additional transfer to the council and pay a fee of five dollars, upon which the council would investigate his record during the interim between his former investigation and the time of second application, make a transcript of his complete record and transmit to the additional state where he may desire registration. And this procedure would be followed in as many transfers as the applicant might wish to make.

"In the case of an architect who had received regis-

THE AMERICAN ARCHITECT

tration in the state where he resided on account of the 'exemption clause' and because of years of practice at the time the law went into effect, he would not be entitled to registration in another state without examination, as no other state would be under legal obligation to accept him without examination. In consequence, architects who have received registration under the 'exemption clause' are urged to waive that right and be registered in their home state by examination. The council is recommending that in all such cases the form of examination for architects of ten or more years' independent practice of the profession of architecture as principal in charge of an architectural office, that these architects be given a special examination by exhibits in which they shall submit to the examining committee plans, specifications and detail of a number of their more representative buildings and appear before the committee with these exhibits, answering such questions

as shall be put to them tending to indicate that they were the real authors of the work, notwithstanding the fact that the drafting and clerical work may have been executed by others under their supervision. And if, in the judgment of the examining committee, they show a record in practice indicating competency equal to or in excess of the competency that might be indicated by a written examination prepared in accordance with the law, they should certify to the proper authorities their right to registration by examination.

"Architects of ten or more years' practice residing in states where there are no laws regulating the practice of architecture should take such an examination as above indicated in the state having registration laws nearest to where they reside.

"E. S. HALL, Secretary,
"National Council of Architectural Registration
Chicago Boards."



HOUSE OF F. W. PENFIELD, GLENCOE, ILL.
N. MAX DUNNING, ARCHITECT

American Specification Institute

We are heartily in favor of the movement suggested in your editorial of November 17. Such an organization as "The American Specification Institute," whose object should be to increase the knowledge of its membership, in relation to the preparation of definite specifications, should receive the hearty support of every practicing architect.

Your editorial in November 17, of THE AMERICAN ARCHITECT speaks the truth in relation to altogether too many specifications when you charge that "The preparation of specifications receives less study and attention in proportion to their importance than any other phase of architectural or engineering practice."

The growth and development of the very complicated work of the present day architect calls for the fullest development of every branch of his service. Heretofore much effort has been put upon the development of carefully wrought drawings and details covering all the various parts of the work. This is as it should be, and in so doing the architect has kept pace with the almost abnormal requirements. The work of preparing the specifications was pushed aside as of not much importance; however, it has been found that as a companion of complete and accurate drawings which together form the basis of every contract, the specifications should have the same careful consideration and be prepared by those experienced and skilled in specification work.

As the work under the care of the architect becomes more and more complicated and important, the necessity of perfect (if possible) specifications will be more and more apparent.

Too often the specifications only meant so many typewritten pages to be discarded by the builder because of their discrepancies and meaningless and impossible requirements, indicating a lack of knowledge of good construction principles, the proper use of materials and equipment.

Specifications should be accurate and definite the same as is required of the drawings.

SAMUEL HANNAFORD & SONS.

Cincinnati, O.

Replying to your letter of November 24, I have been greatly interested by your editorial of November 17, on the American Specification Institute. Specification writing has undoubtedly lagged far behind the advancing standard of architectural practice generally. Your proposal to give prominence to this work is exactly in the right direction.

JOHN GALEN HOWARD.

San Francisco, Cal.

I concur in almost every detail with your editorial and feel that there is need for a better set of specifications than is now adopted by the average architects' offices, and it appears to me that the formation of a specification institute would be a much needed service that can be rendered to architects.

G. LLOYD PREACHER.

Augusta, Ga.

We are in receipt of your letter of November 24 asking our opinion of The American Specification Institute.

We cannot entirely indorse the statement that the specifications are the least creditable part of an architect's production. The object of both drawings and specifications is to form a definite basis for estimating and construction, and in our experience questions arise due to the defects in one as much as the other. It is axiomatic that better information and education are desirable.

As to The American Specification Institute, however, your article does not give sufficient particulars on which an opinion may be formed. Is this an association of specification writers? If so, who is getting it up? What are the objects and how may membership in it be obtained? We should be glad to receive further information on the subject.

CARRERE & HASTINGS.

New York, N. Y.

In answer to yours of November 24 in regard to the American Specification Institute, I am much interested and would like to know more about this.

I thought that our Structural Service Committee of the American Institute of Architects was doing this work and doing it well. At present I see no reason for a rival organization.

I await your next letter with interest.

H. J. CARLSON.

Boston, Mass.

Your letter of November 24 referring to editorial of November 17 received, and we are glad to inform you that we heartily approve of the plan.

Whether the formation of an institute is the ideal thing to do we are unable to state, but some good, sound articles on specification work, in your magazine, will certainly be of great value to every architect.

MALCOMSON, HIGGINBOTHAM & PALMER,
per C. W. PALMER.

Detroit, Mich.

Old State House, Newport

(See reproduction of original drawing by O. R. Eggers on opposite page)

The public buildings designed during our early Colonial period are, in general, excellent in design.

While simple in style they have a certain elegance that may properly furnish inspiration to modern builders. It is in its disciplined and almost universal refinement and dignity that lies the chief beauty of this work. Even when the early builders sought to venture on display they seemed to possess an innate sense of good breeding which taught them to avoid the vulgar and the eccentric.

This rugged refinement is shown in the fact that classic detail was a common language, and even the humblest carpenter was able to use it with intelligence and appropriateness to express the joy he evidently found in his work.

*The State House at Newport was built in 1743, and Richard Munday was its architect. Olaff C. Revin, writing in the Georgian period of Munday and his work, states: "This building is symmetrical, well proportioned and quiet. For suggestion Munday depended on the type then in vogue. * * * The dimensions are forty feet by eighty. Honestly constructed of brick and stone, it bravely promises to weather the seasons for many generations to come."*

Some critics of the architecture of our Colonial period have contended that, while its purity and classic beauty cannot be questioned, it was nevertheless based purely on domestic types. This State House at Newport is cited as a case to prove this contention.



OLD STATE HOUSE, NEWPORT, RHODE ISLAND
THE AMERICAN ARCHITECT Series of Early American Architecture

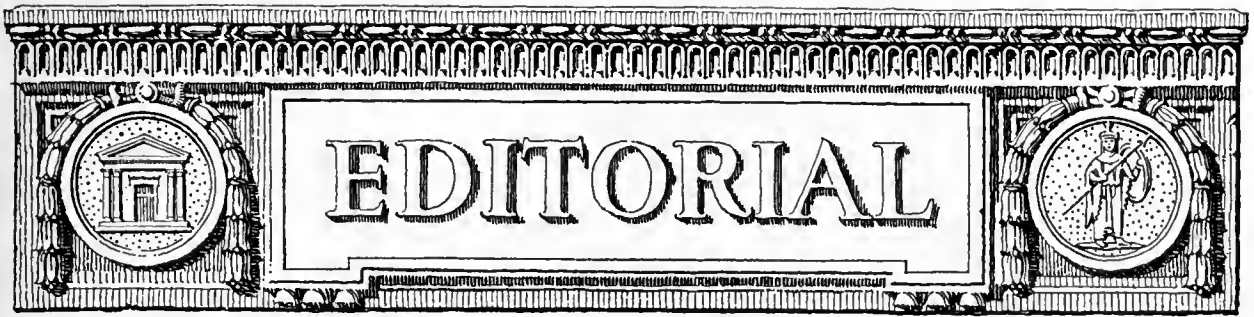

Ignoring Our American Art

ELSEWHERE in this issue there appears a news item stating that Frank Brangwyn, the English painter and etcher, has accepted a commission to decorate the dome of the state capitol in Jefferson City.

The Missouri press, seeing only the obvious result, passes by the deeper, more subtle one, and enthusiastically congratulates Missouri on its selection of an artist.

We do not challenge Mr. Brangwyn's competence to carry forward the work in hand. He will doubtless undertake it with that same spirit and skill which has been at the base of his success. But the question must be asked, why was this important work not assigned to some American artist. It would have been an opportunity that might with advantage to American art have been availed of, for if the American spirit is to prevail anywhere, surely an American capitol building would suggest itself.

American art will be slow to arouse world interest if Americans themselves give such evidence of lacking confidence. If America herself is indifferent to her genius, where can she hope for the respect she craves from the old, sophisticated nations across the seas? Why should the decoration in an American capitol building express the feeling of one whose traditions have nothing in common with American traditions and whose work is necessarily colored by other and foreign ideals? This great country is not without its genius, but genius needs to be appreciated. It is an injustice to American artists to deny them the opportunity for service. It is against the spirit of American art to assign so typically American a commission to one without "America first" in his heart. It is against the interests of America to ignore its home product and go so far afield for talent.

This country is famous for the way it has advertised its own powers. It has developed its resources, encouraged its commerce, cheered and boosted everything American. It would seem a duty for those in charge of art matters to do their part to stimulate American art also and help it to those heights which give us pride in other things American.

Where Does the "Evil" Lie?

THE *New York American* of February 14 printed a long and misleading editorial on the "evils" of the so-called Esch-Cummins law. "Each day," this newspaper stated in a headline, "Reveals New Evil in the Esch-Cummins Law."

Now, there is much that is good and much that is bad in that editorial. It is of vital interest to every architect in the country, because an architect's bread is buttered by no one factor more than efficient transportation. The so-called Calder Committee (the Senate's Special Committee on Reconstruction and Production) very clearly proved that. Housing all over the country progressed or stopped in direct ratio to the effectiveness of the transportation facilities to and from any given point. This, of course, was a self-evident fact before the investigation was begun by the Committee. Whatever Senator Calder and his colleagues unearthed merely substantiated a fact of which all architects were only too well aware. In any industrial scheme as complex as ours, transportation necessarily must play one of the most important parts.

Knowing that, architects should be, and undoubtedly are, familiar with the provisions of the Esch-Cummins law. The point most at issue just now is the recent contracts which the private managers have made with private repair companies for the repair of locomotives and cars. It is contended that the railroads have always maintained their own repair shops, and have kept the accounts of the average costs of repairing engines and cars. This average cost was between \$4,000 and \$5,000 for a locomotive, but today the repairs are said to cost about \$20,000 per locomotive, due to the fact that the repairs are done by private companies, not directly connected with the railroads, but "controlled" by the financial interests which maintain the Class 1 railroads [the Pennsylvania and other large systems].

If this be true, the railroads are most certainly at fault and should be made to continue their repairs under the old scheme, because under this new arrangement, the total cost of repairs to locomotives and to cars is more than \$750,000,000 a year.

THIS would be all right, if the railroads themselves met this huge expense. But they do not meet it. The Esch-Cummins law provides that the stockholders of the railroads shall have $6\frac{1}{2}$ per cent. dividends, but under the "guarantee" system and the high rates made necessary to meet that arbitrary dividend, the American people must pay out more and more until the $6\frac{1}{2}$ per cent. level is reached.

If all these charges are true, and if it is actually found that the repair factor in the operation of American railroads is being artificially and deliberately increased because of a desire to profiteer, then the officials of whatever railroad companies are involved in such practices should not only be *compelled* to explain every detail, but also to go back to whatever order of things is best suited for rigid economy.

As indicated above, this is of extreme importance to every architect. Everything that goes into any building or arch or memorial or anything else is directly affected by the cost of transportation. The price and the availability of the smallest nail, as well as of the largest beam, are both immediately and directly affected by the efficiency of the transportation facilities of a community.

Now, where does the "evil" lie?

You will find this journal's answer to that question in our next issue.

The Holy Land in 1920

NÉITHER stuffy tenements nor dirty factories, narrow streets nor sullied slums will be tolerated in Jerusalem and other urban centers of Palestine, "the Jewish Homeland."

Anticipating a heavy influx of Jews back to the Holy Land, a city and town planning commission has been appointed to regulate the distribution of population, and prevent a mushroom growth from spoiling forever the beauty of the ancient cities.

All town plans will have to be approved by the commission. Civic commissions with full authority will control building development in Jerusalem, Jaffa, Haifa and Tiberias, working on plans approved by a central commission. This body may be headed

by Sir Patrick Geddes of the University of Edinburgh, town-planer of Bombay and other cities of India. Landowners have been advised to consult with the local commissioners before attempting new construction.

Palestine is now half empty and there is ample room for new communities and modern quarters. In building them the poor must not be huddled in crowded settlements while the rich enjoy spacious houses and delightful gardens.

It is the duty of the government to supervise such things. It is hoped to have here noble cities with parks and open spaces, designed, not in the foreign extraneous style, but breathing the spirit of the land, representing the best ideals of those who work for its upbuilding.

IT is interesting to learn that concessionaires have applied to General Ronald Storrs, governor of Jerusalem since the city was captured by Lord Allenby, for permission to run a street car line to the Mount of Olives and an interurban to Bethlehem. There is a shock in the news; it seems like some of the more objectionable fooling in "Innocents Abroad." but it is a sober fact. Remembering that Palestine, the Holy Land and the center of the religious aspiration of so large a part of humanity, is still an ordinary inhabited country with citizens who want to do business and manage their affairs like other communities, serves to give some idea of the difficulty of the task of the British governor. Drinking bars have been forbidden in the city; the street railways to the holy places have been refused franchises; modern building of all sorts is forbidden, as the feeling is that the country should preserve as much of its patriarchal look as can be saved.

The conflict between historical and artistic interest and the economic development of a country is an ancient one. Italy suggests itself for comparison, and seems to show that compromise is possible. The Italians developed their industries as much as they could, but still with attention to the tourist values, the only thing, incidentally, that enabled the Italian nation to come through each year with a credit balance on the national books.

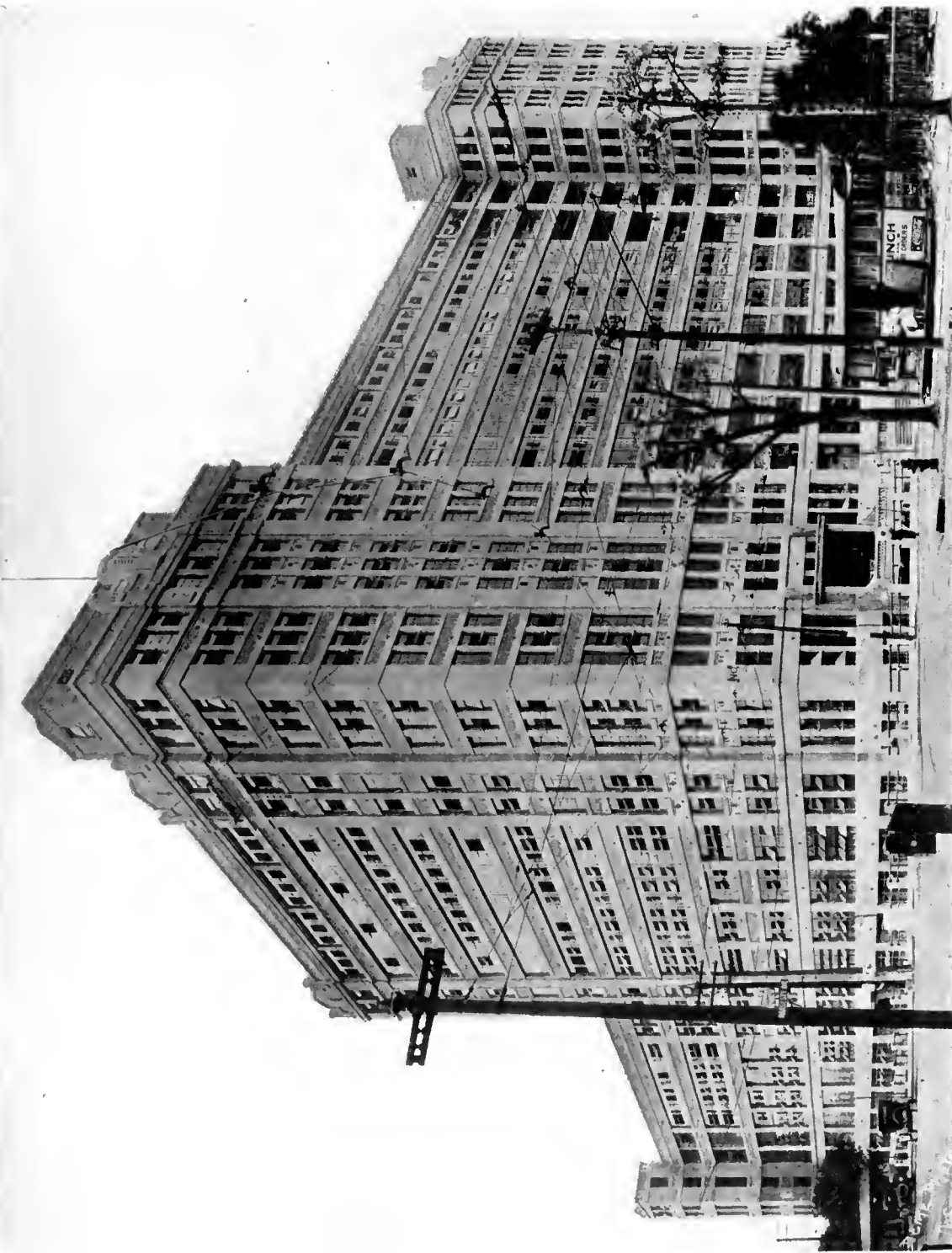

BUILDING FOR NATIONAL CLOAK AND SUIT COMPANY, KANSAS CITY, MO.
N. MAX DUNNING, ARCHITECT

211





DORMITORY "C" AND BOILER HOUSE
BETHANY BIBLE SCHOOL, CHICAGO
N. MAX DUNNING, ARCHITECT



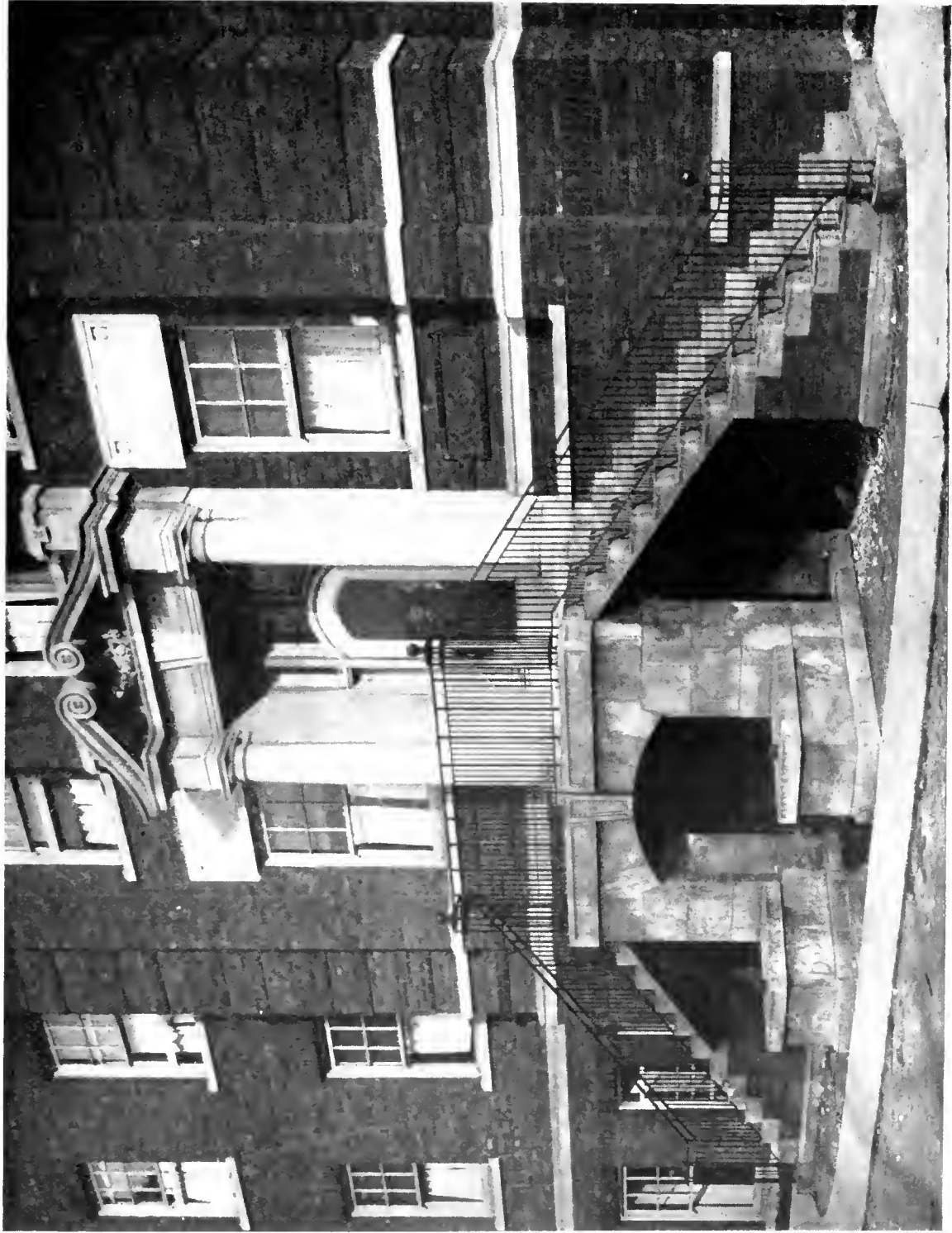

DETAIL, COURT ENTRANCE, DORMITORY "B"
THE BETHANY BIBLE SCHOOL, CHICAGO
N. MAX DUNNING, ARCHITECT



F2624

ENTRANCE DETAIL
OFFICE BUILDING FOR SIMMONS MANUFACTURING COMPANY, KENOSHA, WIS.
N. MAX DUNNING, ARCHITECT

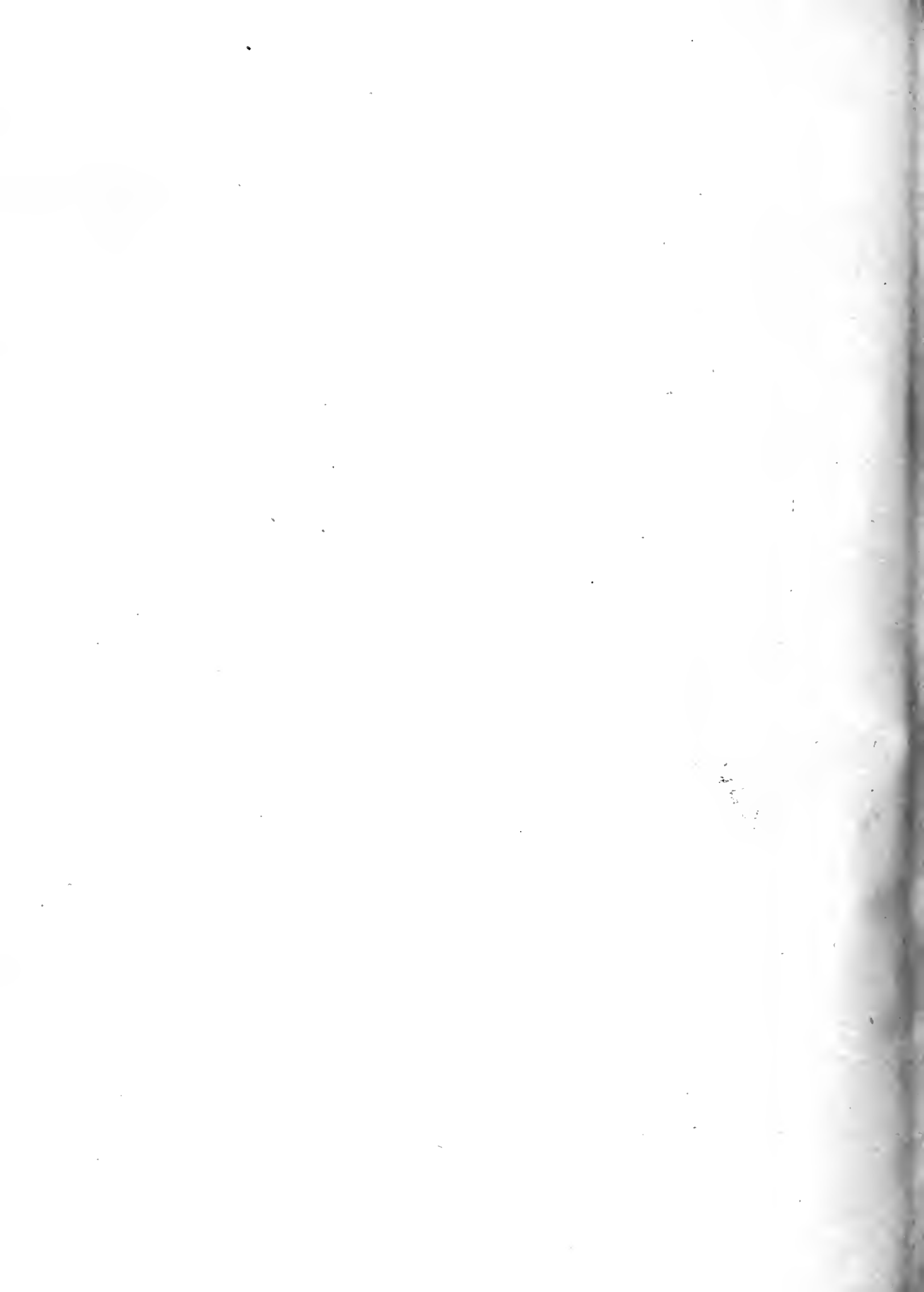

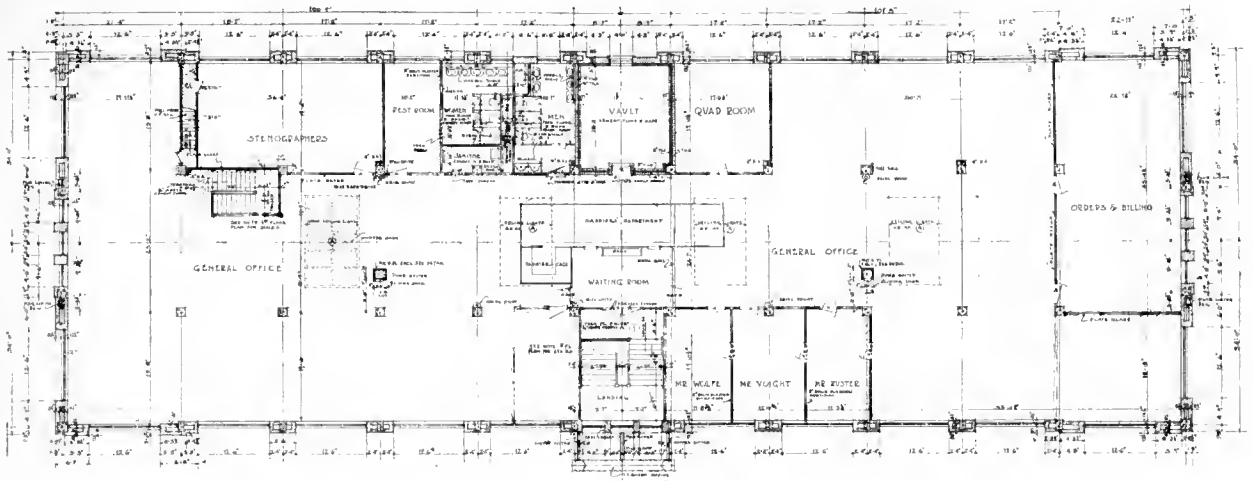

SECOND FLOOR PLAN

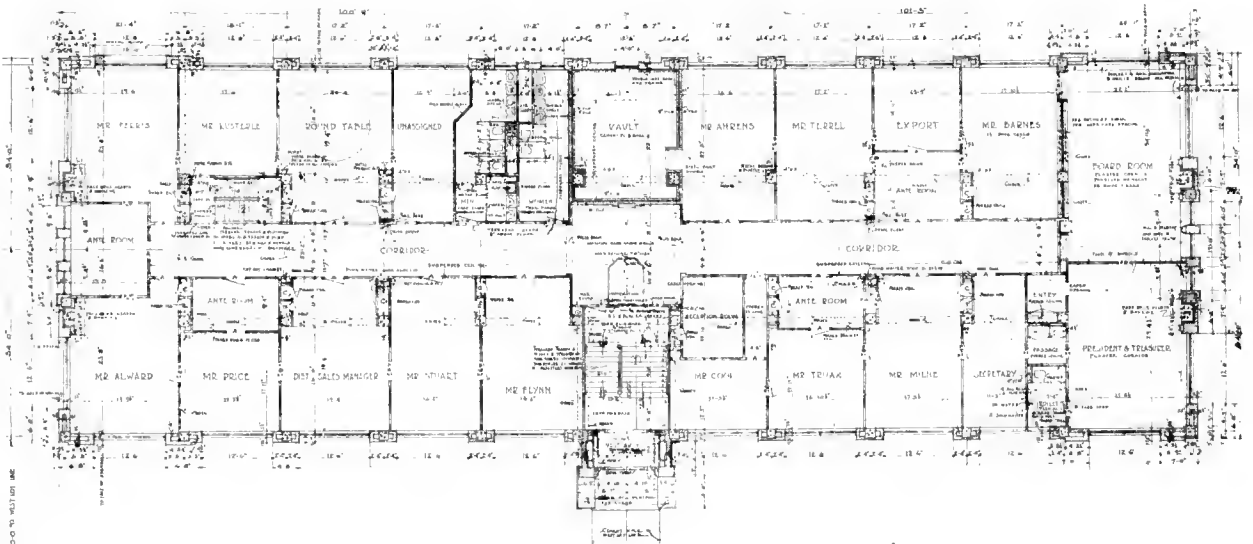

FIRST FLOOR PLAN

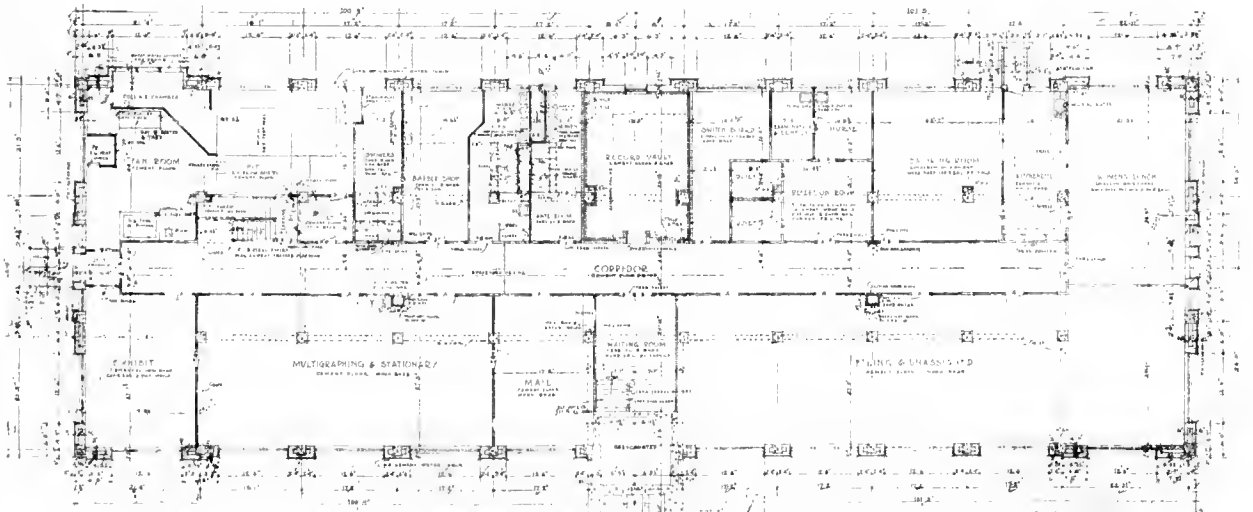

PLAN OF BASEMENT

BASEMENT PLAN
 OFFICE BUILDING FOR SIMMONS MANUFACTURING COMPANY, KENOSHA, WIS.
 N. MAX DUNNING, ARCHITECT



BOARD ROOM
OFFICE BUILDING FOR SIMMONS MANUFACTURING COMPANY, KENOSHA, WIS.
N. MAX DUNNING, ARCHITECT

122



HOUSE OF ROBERT E. WARD, WILMETTE, ILL.



HOUSE OF F. C. TRAYER, KENILWORTH, ILL.
N. MAX DENNING, ARCHT.

DEPARTMENT OF ARCHITECTURAL ENGINEERING



POWER HOUSE—PHILADELPHIA ELECTRIC COMPANY, PHILADELPHIA, PA.
The coal unloading tower is seen to the right

Steel Sheet Piling

Application, Design and Methods of Construction in Foundations

By CHARLES S. BOARDMAN

STEEL sheet piling has found application in foundations in many ways. Its growth has dated from its first use as curtain walls driven along the foundations of buildings adjacent to new foundations requiring deeper excavations for the purpose of holding securely the foundations of old buildings and materials under them. This use has now developed so that sheet piling has found successful and growing application in underpinning of these older foundations of adjacent building and in underpinning the building foundations along route of subway construction. Its next application was in general cofferdam work surrounding a building site or in small pier cofferdams to unwater these

areas in which to construct the foundations as planned. This application of this type of piling to foundation work is generally understood.

During twelve years of study in the design and development of sheet piling, however, the possibilities of its use in deep open cylindrical cofferdams or caissons for building pier foundations as well as for bridge pier and other deeper foundations have been very apparent. The progress in this direction, however, has been slow, due to the necessity for a complete change and for abandoning old plants and erecting new plants for a method the merits of which were not thoroughly understood.

It is not uncommon now in bridge pier design



METHOD OF USING PILE DRIVER RIG
Steel pipe holds cylinder of piling vertical for driving

to make pier excavation in open cofferdams of steel sheet piling, seventy to ninety feet in depth, using telescopic cofferdams of two or more leaves, each leaf of thirty to fifty-foot lengths of sheet piling. Single pieces fifty to seventy-five feet long have been used in a number of instances in various construction jobs. It has also been demonstrated by improved methods of installation, and by assembling the piling in wall form, splicing piles for longer lengths is entirely practicable.

Experience has thoroughly demonstrated the water tightness of single wall

sheet piling, both straight and circular construction, by side contact or by compression and side contact.

A preconceived plan and method in building pier foundations in open caissons of steel sheet piling, as in other types of building foundations, is necessary, particularly in large power house foundations. The Buffalo General Electric Company's River Station, Buffalo, N. Y., and the power house of the Philadelphia Electric Company, at Philadelphia, Pa., and part of the foundations of the new power house, Lackawanna Steel Company, Buffalo, N. Y., were constructed by this method, using Lackawanna steel sheet piling.

The new power plant of the Lackawanna Steel Company, Buffalo, N. Y., recently completed, has an interesting foundation, inasmuch as steel sheet piling was used in four distinct and separate applications.

This power house was constructed on a site previously excavated for a canal slip in Buffalo Harbor to 23 feet of water. The materials as shown by a cross section below were mud and silt, sand and gravel and hardpan to rock.

This foundation required first a single-wall braced cofferdam within which to construct intake and pump well. This required 14 x 3/8-in. arched-web Lackawanna steel sheet piling, 44 ft. in length.

This cofferdam was constructed by first excavating the remaining materials from the slip. The bearing piles were driven and followed to grade and the cage of bracing was framed, the bottom tier first

and building up on this until complete, allowing the cage to sink of its own weight. Additional weight sunk cage to water level. The piling was then assembled around the perimeter of this cage and the closure pile set when all the steel sheets were driven. The steam pile driving hammer was suspended from end of derrick boom. Upon placing of pumps the cofferdams were ready to be pumped out.

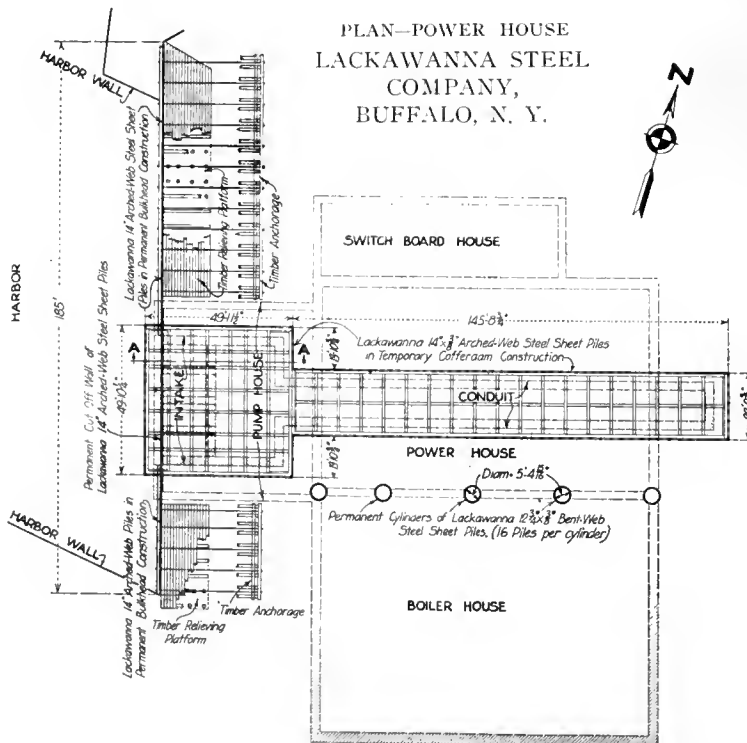

THE AMERICAN ARCHITECT

This improvement also required a bulkhead or dock wall adjacent to and on both sides of power house to hold in place soft materials and a fill place to bring the site to yard level. The bulkhead required 14 x 3/8-in. arched-web piling, 53 ft. in length.

To make bulkhead continuous, a cut-off wall of 14 x 3/8-in. arched-web piling about 22 ft. long had to be constructed under the intake well. This was accomplished by driving piling in the cofferdam after it was unwatered and by moving one timber in each of four tiers of braces at one time.

Since the loading on partition wall between power house and boiler house was heavier and since the foundation was also in canal slip area, five cylindrical piers to bedrock were needed. These were constructed within walls of 14 x 3/8 in. arched-web piling, 42 ft. in length.

The method of constructing these cylinder piers



CYLINDERS ASSEMBLED FOR DRIVING

Cylinder at the left has been driven

here used differed only in that a fixed leader pile driver rig was blocked in position to hold the mast vertical. The method of doing this will be described later.

The building is approximately 240 x 223 ft. in plan, with a floor level about 40 ft. above bedrock and about 5 ft. above water level. A series of bore holes developed that bedrock lay almost horizontal and about 35 ft. below the surface of the ground. From 5 ft. to 7 ft. of mud and silt, 25 ft. to 28 ft. of sand or quicksand, and 3 ft. of clay, containing large gravel and small boulders, lay on the rock.

The plan called for 157 cylinder piers varying in diameter from 33 to 81 inches. The maximum compressive stress allowed anywhere on the reinforced concrete was 500 pounds per square inch. The larger piers carry as high as 874 tons per pier. These foundations were constructed in open cylinder caissons of steel sheet piling, 12 3/4 x 3/8-in. straight-web and bent web sections being used.



CLOSE-UP OF CYLINDER AFTER DRIVING

Excavation has not been started

CYLINDER DIAMETERS FOR BENT-WEB PILING.

Number of Piles	Angle of Bend in Web of Steel Pile	Diameter
18	0 degrees straight web	73"
16	4 " bent web	5' 4 15/16"
14	7 " " "	4' 8 13/16"
12	11 " " "	4' 11/16"
10	17 " " "	3' 4 9/16"
8	26 " " "	2' 8 7/16"
6	21 " " "	2' 3/8"
4	90 " " "	Four 90 degrees bends

Cylinders of 8, 12 and 14 piles of bent web piling and cylinders of 18 and 20 piles of straight-web piling were used. In these cylinders 1,296 tons of piling in 33-ft. lengths were used. The piling remains permanently in position as part of the structure. The accompanying plan shows the general arrangement and size of the piers.

The pier foundation work consisted essentially in driving closed cylinders of sheet piles, excavating the enclosed material by jetting it out, and filling the opening left with reinforced concrete. The construction of these cylindrical piers is novel and original, both in design and execution. Two cableways with two portable timber towers 70 ft. in height, built on skids, were placed over the center lines of two rows of piers and were used to handle the piling, timber mast, steam pile driving hammers, wooden assembling tower, etc.

A timber pile was first driven on the exact center



SHOWING TEMPLET AND CENTER STEEL PIN

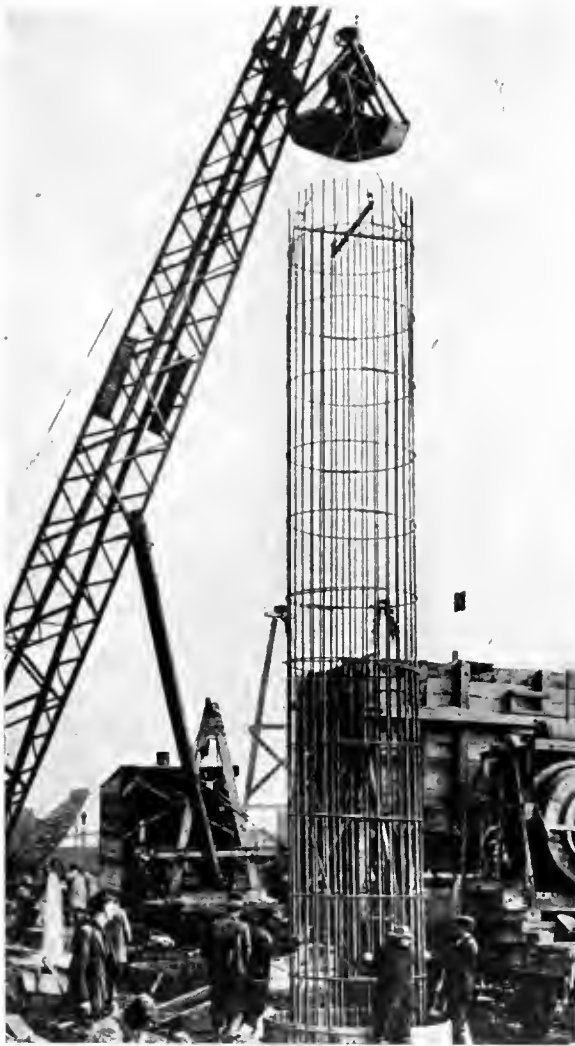

PLACING REINFORCED STEEL CAGE IN CYLINDRICAL WELL

of each pier. These piles were later dressed at the top and a hole bored at the center of pier. Excavation proceeded around this pile to a point near the water level, when the lower templet was set in position and secured to the center pile. The timber assembling tower was then placed over the lower templet, and the upper templet and guide ring were centered in this tower in correct position over the lower templet.

The steel sheet piling was handled by the cableways and assembled one piece at a time around these templates, the cableway being of sufficient height to raise the pieces above the 33-ft. sheeting already assembled. Thus, the piles could be interlocked at the top. The position of the cableways also permitted all of the piles in one cylinder, or all the cylinders in the row, to be assembled.

This method of assembling allowed the entire cylinder to be set and held vertical, and the closure pile assembled for its entire length. A 14 x 14-in. wood mast, 43 ft. long, was then mounted and held in position on top of the wooden pile by a 2-in. steel pin. This was guyed at the top by four $\frac{5}{8}$ -in. wire cables, the mast being free to move within the top templet.

A No. 7 McKiernan-Terry steam pile driving hammer, weighing 5,500 lbs., was lifted by the cableway and supported from the mast by a steel A-frame so designed as to allow the hammer and frame to slide freely upon the mast. The mast was free to revolve, and the hammer was offset from the mast the required distance to bring it centrally over the pile walls. The hammer was lowered or raised by a set of double blocks provided on the side of the mast above the hammer, the power line passing over a sheave in the top of the mast to the stationary hoisting engines.

Two sheet piles were driven by this steam hammer about 3 or 4 ft. Then the hammer was raised and placed upon two adjacent piles, driving them about the same distance. This operation was repeated until the entire circle was driven into bedrock. The average time of driving was about 6 hours for each



DIVER ENTERING CYLINDER TO EXAMINE ROCK SURFACE

cylinder. A large portion of this time was required to drive the piles through the glacial drift and into the disintegrated top of bedrock. Penetration into rock as closely as can be determined from original borings was from 6 to 18 inches. The work of assembling and driving the cylinders was entirely completed in a total of about 70 working days.

A multiple-stage centrifugal pump with a capacity of 1,500 gal. per min. against a pressure of 125 lb. per sq. in. was installed on a timber pile trestle on the shore of the river. An 8-in. main with a 6-in.

THE AMERICAN ARCHITECT

distributing pipe carried the water close to the cylinders. A sand jet pump constructed with a 6-in. pipe about 40 ft. long, having an elbow at the top, and a right angle pipe 10 ft. long (with two water jets fastened to opposite sides of this pipe) was used as a water jet pump. The two pipe jets had reducers at the lower end. One 2½-in. reducer was turned upward and toward the center of the bottom of the 6-in. pipe, the other 1½-in. reducer was straight and extended about 12 in. below the end of the larger pipe. These jets had the effect of stirring the sand and forcing it upward through this larger pipe. To complete this pump a 2-in. pipe connection was made in the elbow, directly opposite the horizontal piece of 8-in. pipe. These three jets were connected to the pump by fire hose.

The pump thus assembled was raised by the cableway and stood vertically in the material within the cylinder, the upper end of the 6-in. tube being closed by a gate valve. The water was then turned into the jets, and as the only avenue of escape was through the bottom the pump rapidly settled under its own weight to the bottom of the cylinder. The gate at the top of the pump was then opened and the pressure from the jet caused a large stream of sand and water to be discharged. This method of excavation proved to be so rapid that only 2 hours were required to remove all the sand, the loose material from a cylinder. An independent jet was used

until the hard formation was broken up so that it could be removed by a small orange-peel bucket. The final operation in cleaning bedrock inside the cylinders was to replace the large jets by 2-in. jets, one operating vertically, the other horizontally. These carefully washed the rock and the degree of cleanliness of the bottom was thoroughly tested with a sounding rod.

After inspection had proved that the rock was clean and ready for concrete, the jet pump was removed and a cage of reinforcing steel, previously assembled, was lowered into the cylinder. These steel cages were provided with stub guides which

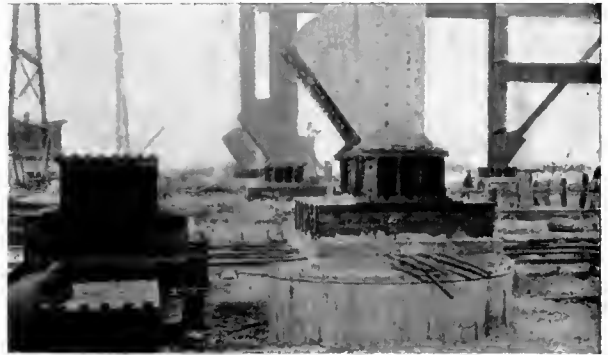

CLOSE-UP OF COLUMN FOOTINGS
Showing reinforcing steel at floor beam level

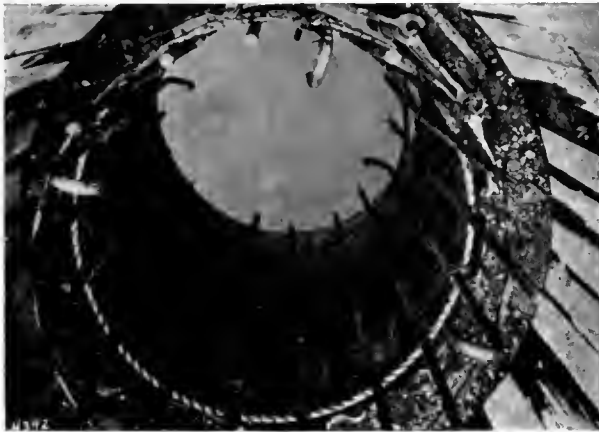

LOOKING DOWN INTO CYLINDER
Rain water collects on top of concrete

to clean the sand and material from near the walls of the cylinder. Circular wooden forms were bolted to the top of the steel cylinders to permit the spoil to be used to raise the general ground level.

To remove hard clay conglomerate, heavy gravel and boulders remaining in the cylinder, a 14-in. arched web 35 ft. long, weighing 1,425 lbs., was hung inside and used as a vertical battering ram

held them in proper position relative to the sheet piling forming the cylinder shelves.

Concrete was chuted to the hopper of an ordinary tremie pipe which deposited it on the bottom. The tremie was hoisted and sections of it removed as the level of the concrete rose. The lower end of the tremie was maintained from 1 to 2 ft. below the surface of the concrete. It was operated with extreme care so as never to lose its seal in the concrete nor its charge of concrete.

By this method each cylinder was filled with concrete to a point 2 to 3 ft. below the top of the sheet piling. After allowing sufficient time for the concrete to set, water was pumped out of the top to the level of the concrete, and the laitance (usually 2 to 3 in. deep) was removed.

The wooden forms were then built for the cap of the pier and the reinforcing bars required for the floor beams were placed in position. All the concrete for top and caps was poured at one time. The reinforced concrete caps of piers were 2 ft. larger in diameter than pier. The steel sheet piling, therefore, carried part of load on pier.

This work was designed by the Stone & Webster Engineering Corporation, Boston, Mass., and was executed by the Stone & Webster Engineering Com-

pany, George Q. Muhlfield, Construction Engineer, S. L. Shuffleton, Western Manager in charge, and E. C. Macy, General Superintendent. H. G. Stott was Consulting Engineer for the Buffalo General Electric Company.

Upon the completion of this power house, the contractors moved their forces and plant to the site of the Philadelphia Electric Company's power house, Philadelphia, Pa.

These foundations of the boiler house and coal tower unloader were constructed in an almost similar manner to the foundations of the River Station of the Buffalo General Electric Company. They differed in the number and size of piers, however, there being but four rows of piers, of seven piers each under the boiler house and four piers only under the coal unloading tower, all these on centers of 37 ft. and 25 ft. These piers were about 14 ft. in diameter or larger and made up of 38 or more pieces of Lackawanna 14-in. arched-web piling in 37 to 55 ft. lengths.

This foundation was constructed on the site of an old shipyard with old timbers and timber piles buried in the old ship ways. At the center of each pier a timber pile was driven. In this pile at the exact center of pier was bored a 2-in. hole to receive the pier at the bottom of the timber mast. The ground timber templet was then carefully placed and held securely. After the upper templet was set and held, the steel sheet piling was assembled and the timber mast was placed, set and held at the top by steel cables, after being carefully pumped.

The hammer drove two piles a few feet at each driving. Then it was raised and placed on adjacent piles, continually driving in this manner until the cylinder of sheet piling was finally driven to bedrock.

In cylinders of steel sheet piling, the length of steel should be such that when driven into rock the top of steel cylinders should be as nearly as possible at the level of low water. The design of the pier should contemplate a reinforced concrete cap of larger diameter than the sheet piling cylinders so that the piling can be figured in the bearing value of the pier.

The New York City specifications for bearing values of steel shells of this character were given in a previous article on foundations, appearing in THE AMERICAN ARCHITECT, November 3, 1920.

A careful analysis will show that one large cyl-

inder of steel sheet piling, with possibly some reinforcement, will simplify any foundations where otherwise a cluster of bearing piles is required. It also has the advantage of having a large area in bearing on bedrock which has been examined and cleaned.

The simple method of assembling, the driving in one operation, the necessity of one excavation only, the ability of steel sheet piling to conform in its bottom edge to the rock surface, the examination of the rock surface by steel ram or diver, the ability of cylinders to retain their cylindrical shape even though excavated in wet to considerable depths, and the trueness of a cylinder so that a cage of reinforcing steel or steel bracing can be lowered, through the water and the cylinder pumped out when bracing is placed, make this form of foundation elastic, and economical both in design and execution.

Fire-Protective Materials for Steel Columns

TESTS on the fire-resisting qualities of various kinds of protections for steel columns have recently been conducted by the Associated Factory Mutual Fire Insurance Companies, the National Board of Fire Underwriters and the Bureau of Standards.

The results of these tests show that the period of resistance for an unprotected column is only ten minutes. Solid columns partly protected by filling the re-entrant spaces with concrete to the extreme of the metal stood up from one-half to three-quarters of an hour, while open-latticed columns under the same conditions stood up from 2 to 3½ hours.

The best protective results were obtained with a limestone or calcareous gravel concrete covering to a depth of 4 inches. All the columns so protected withstood the eight-hour fire test, and, while hot, sustained such large additional loads as to justify the conclusion that in the lower range of results with similarly protected columns the working load will be maintained during an eight-hour fire period.

Common surface clay brick laid on side to form a solid protection about 4 in. thick resisted fire for a period of five hours and proved to rank second to concrete in this respect.

FIRE RESISTANCE PERIODS DERIVED FROM TEST RESULTS.

Type of Column	Protection		Min. Sq. In. Solid Mat'l	Inches, Thick. of Protection	Period Fire Res. min.
	Material	Details			
Struct., steel	Not protected.	Min. thick. of metal 2".	8	..	10 min.
Struct., steel, solid	Partly protected by filling re-entrant space with concrete.	Mixt. 1:6. Vert. and horiz. steel ties.	60	..	¾ hr.
Struct., steel, open lattice	do.	Mixt. 1:6. Filling ends to outside rivets and covers lattice and main members.	120	..	3½ hrs.
Struct., steel	Port. cement plaster on metal lath.	1:1-10:2½ Port. cement, hydrat. lime, sand.	80	2 layers, each ¾"	1½ hrs.
Struct., steel	Conc., limestone or cal. gravel.	Mixt. 1:6. Conc. tied.	200	4	8 hrs.
Struct., steel, solid	Hollow tile surface clay, hollow tile fill.	Motor joint bet. tile and col. flanges and webs, metal ties in horiz. joints.	240	2 layers, each 2"	3 hrs.
Struct., steel	Common brick, surface clay.	Brick laid on side.	240	3¾	5 hrs.

Current News

Happenings and Comments in the Field of Architecture and the Allied Arts

American Architects Invited to Exhibit in Paris Salon

Through the courtesy of Monsieur Maurice Casenave, Director General of French Services in the United States, an invitation has for the first time been extended by the Société des Artistes Français to the American Institute of Architects to make a comprehensive exhibition of American architecture at the Paris Salon which opens in May, 1921. The drawings will be selected by the Committee on Foreign Building Cooperation of the Institute acting as a jury. While this exhibition is gotten up under the auspices of the Institute, it is open to any architect in the country irrespective of Institute membership.

A charge of \$1.50 per square foot on drawings accepted will be made to cover cost of crating, storage, hanging, etc., the French Government paying the expenses of transportation to and from Paris.

Insurance on exhibits can be arranged for by the Committee from the time of their departure from New York until their return at the rate of \$1.50 per hundred dollars if desired by exhibitors.

To allow sufficient time for transportation to France, the date for submission of exhibits has been set for February 14.

Those desiring to exhibit should apply to Mr. Julian C. Levi, secretary, 105 West 40th street, New York City, for entry slips which must accompany all drawings.

Brangwyn to Decorate Missouri Capitol

Frank Brangwyn, the English painter and etcher, has accepted a commission to decorate the dome of the state capitol in Jefferson City. The *Kansas City Times* discussing the matter believes that if any painter has found the poetry of industry, it is Brangwyn. He never has looked upon painting as the toy-maker's art, to provide trifles or even treasures to gratify individual whims and fashions. The picture market never appealed to him. His work, whether in separate canvas or as a part of an architectural scheme, is always decorative in idea, never wholly divorced from architecture, but obedient to a scheme of line and color as music is obedient to counterpoint and harmony.

Brangwyn's father was an architect, which may account for the structural quality of his painting

ideas. And yet he did not develop his gifts directly under his father's influence. William Morris helped him, but he was shaped far more by his love of life in its more vigorous aspects.

In the work he will do in the Missouri capitol, he will have free scope and large spaces in which to express himself.

The "eye of the dome," which is assigned to him, measures eight hundred square feet, and the four other spaces he is to fill with mural paintings are each 650 square feet in size. Each painting will be more than thirty-eight feet square.

Westminster Acknowledges American Gift

The Carnegie Endowment for International Peace has received from Herbert E. Ryle, Dean of Westminster, a message of thanks for the gift of £10,000 toward the restoration of Westminster Abbey. The letter, which was made public by Dr. Nicholas Murray Butler, chairman of the division of intercourse and education of the endowment, read, in part:

"The great American people has always had a warm affection for Westminster Abbey, and I rejoice to know that this inheritance from early centuries of English history is felt to be one of those most hallowed pledges of brotherhood which help to unite the two great nations in enduring harmony and good will."

Similar messages of acknowledgment are announced by the endowment from Rheims and Belgrade, where the endowment is erecting libraries to replace the structures destroyed by the German and Austrian armies.

The Neglect of the Back Door

So much has been said about the beauties of old Colonial doorways, the fan-lights, the panels, the knockers and the antique porticos, that the unobtrusive and homely back-door has been grossly neglected. There is, however, a charm, an individuality, and a human touch about the humble back door, which the stately front door can never claim, writes E. G. Babson, in the *Boston Transcript*. The back-door and its environs tell the story of the occupants of the house. Here is one doorway, with a neat little mat outside for the iceman or the grocer boy to wipe his

feet on (he never does, but it shows aspiration); the door-steps are swept daily, the garbage can underneath is in a good state of preservation, perhaps even fenced in. The well-washed dish-towels hang in an orderly row, and the empty milk bottles fairly gleam with cleanliness.

By contrast look at another picture; a broken screen-door, dirty steps, dented-in garbage pail, with cover half off; odds and ends of old cloths hanging up to dry, and broken flower-pots cluttering up the back porch. No invidious reflections are intended to be cast upon those responsible for this latter picture. They may be possessed of all the Christian virtues, but they have acquired an indifferent attitude to the effect of their back-doors on the neighbors. So much of women's time now is spent in the kitchen, why not make the back doorway a place of beauty?

From the back door in the small town or suburb one can see much more interesting signs of life than from the front, which merely shows humanity on parade, as it were. But from the back porch, as I write, I see activities of all kinds; hens in one yard, happily enclosed, and with no four o'clock rooster, visible or audible (Allah be praised!); a doghouse, tenanted by a fairly amiable non-growling canine, several garages and two beehives. Busy housewives are shaking mops and dusters from their back doors, and we exchange a few words on the nobility of labor. Our ashcans, although badly dented, compare favorably with our next-door neighbor's which have lost all semblance to a cylindrical shape. We view our new clothes-line with pardonable pride, and let our eyes wander speculatively to our neighbor's Monday wash, hung out in all its expansiveness. Ah, we draw a veil, but back-door life is interesting—it has the human touch.

Traveling Exhibits of Art

To inaugurate a movement to increase art appreciation among Americans, the American Federation of Arts has launched a series of exhibitions. Beginning with a collection of 400 prints in color and photographs suitable for home decoration recently shown at the Sage Foundation Building, New York, this series will ultimately embrace other items of home decoration such as wall paper, pottery, etc.

A first exhibition of this kind shown last season formed the inception of a campaign for improving home environment on the principle that a picture in the home is a silent partner in cultural growth. That any national organization should make a country-wide effort under the slogan "Art in Every Home" is a novelty in American Life. Yet under this significant motto the Federation, which has 250 chapters in 38 states, has grouped a series of traveling

exhibitions, all bearing on the single purpose of improving home furnishings.

The original exhibition of prints met with such success that two others had to be arranged at once to meet the demands of societies and institutions in different parts of the country.

New publications of American prints have increased so rapidly that a complete revision of the original collection has now been made. These have been selected by a jury of experts. Every taste and fancy of the individual may be satisfied in this exhibition; history, chivalry, love, the home, childhood, music, patriotism, nature in all forms, figure, landscape and sea subjects, in fact, subjects eminently suitable for every home are there. All rooms in the house are taken care of—living room as well as chamber; the boy's room or the girl's room; the den or the nursery. The great majority of the 400 subjects on view are reproductions of works by American artists. There is also a small group of foreign subjects, as well as a number of reproductions of famous paintings by old masters. The prints are in various sizes and finishes, and suitable for framing and immediate use.

New reproductions have also been added from works privately owned.

There is also an exceptionally good series of photographs, among them a selection from paintings in the Metropolitan Museum of Art published by the Museum as part of its extensive educational work.

A most interesting feature of the exhibits is that the Federation will sell at the exhibition rooms copies of all the prints exhibited at prices from 35c to \$18, demonstrating the wide range of selection and the fact that there are offered excellent reproductions at prices that readily accommodate themselves to the size of any home-maker's purse.

The exhibition will form one of a number on tour throughout the country under the direction of the American Federation of Arts; 46 exhibitions of paintings, prints, crafts, war memorials, architecture, etc., being on the road all the time, each being shown in a different city each month.

Factory Machinery No Longer Black

Twenty-five years ago little thought was given to the interior of factory buildings; "sanitation" was an unknown word; proper lighting, health and care of workers were not considered. Today there are very few factories, prompted by the wish for higher efficiency, that do not have interior walls and ceilings finished in white or some other light color.

And it is little over five years ago that careful thought was given to the question of proper lighting

of working areas at night, and in such plants where the nature of the business required very high ceilings and the effect of white walls was not so pronounced, as would be the case in foundries, etc. This led to a careful study of suitable lighting fixtures for such plants and was followed by the development of suitable lighting fixtures for factory buildings of all kinds. Today more and more attention is given to proper illumination for the dark hours of the day and for night work.

Clean, healthy surroundings, fresh air and proper lighting are now the rule and help greatly in insuring the contentment of workers and steady production which will pass rigid inspection.

Today progressive manufacturers are completing the triangle of bright factory conditions by adding to the light walls and the proper lighting fixtures brightened surroundings to the very machine on which the workers are employed. These manufacturers have found that by doing away with the black color so common on machinery and substituting for it a bright, pleasant color they lessen the eyestrain of the worker, do away with his restlessness at the job and materially reduce spoilage.

One company through extended tests along this line has proved conclusively the advantage of light-painted machinery. When given the privilege to choose from machines finished in different colors, all the employes desired to work on the machines finished in the lighter colors. A light gray color has been proven satisfactory because this color is sufficiently off the white light to prevent undue glare and sufficiently light to eliminate dark shadows.

A Silencer for the Street Noises

One of the disadvantages of city life is its noisiness. The larger the population the more kinds of noises there are and the greater is its volume. Most people would gladly escape from it, if to do so were possible.

Hence the advantage of a contrivance invented by Hiram P. Maxim, which has for its object the eliminating of street noises from buildings. It is meant, especially, for apartment houses, hotels and hospitals.

Having effectively muffled guns with his silencer, Mr. Maxim has turned his attention to the hubbub of our city streets.

Of course, nobody can get away from noise who opens his windows upon the streets of a town. Hence it is that Mr. Maxim's invention seeks to do away with the necessity of opening windows for ventilation. He proposes to supply from the roof all the fresh air that is wanted, using machine driven fans to draw it down through the halls and into the rooms.

In order that the air may not bring sound vibrations with it, resort is had to the expedient of silencing it. For this purpose there is erected on the roof of the building a circular structure which has a spiral interior. But it is a broken spiral, and the passage of the air drawn down through it is further interrupted by twists and turns, so as to break up all noise vibrations. It is further suggested that the silencer here described might be lined with felt or some other sound-deadening material.

There are familiar means for making walls sound-proof, so that, in an apartment house or hotel, nobody ought to be annoyed by the noises of his neighbors. In a properly constructed building, then, the occupant of a room should be able to get rid of all noise by simply closing the windows, and this he can do without shutting off the fresh air supply if Mr. Maxim's silencer is in use.

Fighting a Burning Coal Mine Under a City

There is a coal-mine burning under one of Pittsburgh's most exclusive residential sections. The fire started in 1914. A few months later, it is learned from the *Popular Science Monthly*, it spread rapidly and became a source of great danger to the community. To know that a fire is burning under the street you live on, with the possibility that it may actually extend under your home, would not add anything to your feeling of comfort and security.

The people in the Squirrel Hill section of Pittsburgh, where the fire occurred, did not give the matter much thought until the street above the burning mine became so hot that pedestrians were unable to walk upon it. The street was completely undermined by the fire, and part of it caved in.

This was no job for the fire department. Putting out mine fires is a job for engineers. Water could not be used, and it would not do any good even if it were possible to apply it.

When the city engineers reached the fire and studied it, they decided to dig down a short distance and build a clay wall or barrier beyond which it would be impossible for the fire to spread. This plan was put into effect, and it was thought that the fire would soon burn itself out. But the engineers were disappointed. The fire did not burn itself out. It grew hotter and hotter. The heat caused the clay wall to crumble, and the fire spread rapidly to thicker coal deposits.

There was another hurry-up call for the engineers. This time they decided to strip the vicinity of coal as far as possible, and steam-shovels were put to work. The excavation was carried on with great haste to prevent the fire from spreading to sections forty feet beneath the surface. To permit the fire

to reach these areas meant almost complete disaster to the entire community. It was very difficult to fight the fire at depths varying from ten to twenty feet. At a depth of forty feet, effective work would have been almost impossible.

The race with the fire continued for some time. Steam shovels dug frantically. Coal became so plentiful that it was sold to the people in the neighborhood for one dollar a ton. At times during the operations burning portions of the mine were exposed. Although the fire was subdued to a great extent, it was not entirely extinguished. The battle with it is still being waged.

The coal-mine in which the fire started is a very old one. It has been abandoned for forty years. The fire received its necessary supply of oxygen through several openings. It is difficult to imagine how ferocious a coal fire may become, burning underground. As the oxygen is used up in the combustion of the coal, a partial vacuum is created. This lowering of pressure causes air to find its way in from the outside and the fire never lacks a fresh supply of oxygen.

Coal-mine fires are not uncommon, but they usually occur in unpopulated districts, where they are allowed to burn themselves out, owing to the great cost of extinguishing them. A coal-mine burning under a city is a more serious matter—it simply must be put out regardless of cost and trouble. If it is allowed to reach deposits that extend beyond a certain distance underground, the job of putting it out becomes well nigh impossible. The use of dynamite is bad. It loosens the coal and offers more fuel for the fire.

Indians Had 45-Story Apartment House

The discovery of a stone apartment building, forty-five stories high and containing one thousand rooms, believed to have been the home of a now extinct tribe of American Indians, was announced at a meeting of the Archæological Institute of America at Johns Hopkins University.

The apartment was uncovered in one of a group of towns representing an ancient civilization in the midst of the Southwestern Desert. Several thousand persons may have lived in the newly discovered building.

Find a Fine "Rembrandt"

An interesting discovery has been made in a little half lost village in the Harz Mountains. In a house there, states the *New York Times*, a picture in oils of an aristocratic old gentleman has been hanging for many years. It was only a little while ago that the owner thought it might be of value, and made

the discovery that the picture was by Rembrandt. Several experts say there can be no doubt that it is by the famous Dutch master.

The picture is painted on an octagonal piece of oak, about two feet high by one and one-half feet wide. It still is in its beautiful original frame and one of the experts, Dr. Hofstede de Groot, declares that the frame must have been made at Rembrandt's special instructions out of Scotch fir. The work dates from the time of Rembrandt's stay in Leiden and probably was painted in 1630 or 1631. The initials R. H. L., which stand for Rembrandt Harmenzoon Leiden, appear in a typical monogram above the shoulder. The discovery was made by Egon Mueller, a well-known art expert of Hamburg.

Personals

Edward F. Stevens, 9 Park street, Boston, and Frederick C. See, 62 Clark street E, Toronto, architects for medical institutions, have officially announced the formation of a partnership at the same addresses. They have been associated for a number of years.

R. S. Tyson and H. N. Foster announce that they have taken over the office of Mr. J. M. King and will practice architecture under the firm name of Tyson & Foster, with offices in the Woods Building, Ashland, Kentucky.

James H. Ritchie, architect and engineer, formerly located at 8 Beacon street, Boston, Mass., has associated himself with F. R. Jonesburg, and the firm is now operating at 15 Ashburton place, that city. They also have an office at St. Petersburg, Fla.

Herbert C. Hearne, architect, who formerly practiced at 145 State street, Springfield, Mass., is now located at 356 Main street, that city.

Bowen, Bancroft Smith & Geo. Provot, architects, announce that they are now located at 48-50 West 47th street, New York City.

James Kleinberger, architect, is now located at 20 West 43d street, New York City.

Edward Fanning, architect, is now with Goodwin & Woolsey, 4 East 39th street, New York City.

Charles Volz, architect, announces that he is now practicing at 371 Fulton street, Brooklyn, N. Y.

L. R. Barber, architect, has just been discharged from the army and opened an office at 325 Guarantee Trust Building, Atlantic City, N. J.

Weekly Review of the Construction Field

With Reports of Special Correspondents in Regional Centers

A STUDY OF PRICES*

By

EDMUND D. FISHER

(Vice-President, Bank of Detroit)

PART II

[Refer to Page 107, Issue of January 26, 1921]

THE credit swing in prices, however, is the one that is most unsettling to the business world. The movement has been frequently called a "financial cycle." Prior to the organization of the Federal Reserve System the financial cycle seemed to be permanently established as a reoccurring factor in American business life, although each succeeding period had certain characteristics peculiar to itself, which frequently tended to deceive even the veteran business man.

Common to all these periods, however, was a period of inflation, followed by a period of deflation. Such a period was invariably characterized by a crisis year, one or more dull years, culminating in a number of active business years. These active business years were followed by another period of readjustment, included in another financial cycle. As the active years were years of increasing prices and years of growing inflation, it is evident that during these years there were committed the economic errors which were ultimately disturbing to trade and necessitated readjustments of prices and policy.

AVERAGE PRICES 1914-1919

(Annalist Index Number Showing Varying Prices)

1914.....	146.069
1915.....	148.055
1916.....	175.720
1917.....	261.796
1918.....	287.080
1919.....	295.607
Nov. 13, 1920.....	238.557

The period commencing with the World War in 1914 is illustrative of such a period of inflation, whose effects were world wide. The new and abnormal spending power of the various governments, growing out of non-liquid loans, fiat or quasi-fiat currency issues, and increased taxation, "bulled" prices. Business men bid against each other in supplying raw material and manufactured goods to meet war demands. Labor received increasingly higher wages and came into the market for luxuries in abnormal volume. Bank loans increased, following the necessity for increased capital, to

build new factories, and to finance the growing dollar volume of trade. Population of cities increased, weakening the primary basis of production. The normal relations of production, manufacture and distribution were disrupted. Much of the wealth produced was non-productive and fed the fires of war. Yet all these tendencies which made for an inevitable readjustment were more or less obscured for a while, and the feeling developed in the United States that the nation was growing wealthy. People were certainly busy, but finally began to feel through the strain of increased prices that it might be a period of lessening wealth.

Theoretically it is possible to conceive of prices remaining relatively stable during a war period, if the buying power of the people were restricted through saving, offsetting the increased buying power of the government. Practically, however, the people do not save the necessary amount for this purpose. The government, therefore, continues to borrow heavily, bank loans expand and the added spending power thus created stimulates the increase of prices. As a consequence, of course, the value of the dollar itself tumbles.

THE rather comprehensive subject suggested for this address includes in addition to the reasons leading to advance in prices—"What is necessary to bring about their orderly decline." As the phrase is, "There ain't no such animal." That is, yet to be found in the American financial zoo. It could not live with the "bulls" and "bears." An orderly decline in prices must follow a preceding period where business is well under control, where reserves are laid aside to break the shock of future changes, where inventories are not too large, where new equipment and new factories are planned for an average rather than an abnormal business, and where there is a potent economic control working through the entire financial cycle by a strong central banking organization. In the past many European countries have had such relations fairly well established, and where the credit cycle has had no extremes in price movement.

English experience ranging over a long period of years shows that the credit cycle of prices very nearly coincides with the average annual discount rate of the Bank of England. As prices go up the discount rate advances. As prices go off the rate declines. The economic control of the bank over prices is thus made evident. This condition is particularly interesting in view of the power of the

*Copyrighted 1920 by Edmund D. Fisher.

THE AMERICAN ARCHITECT

Federal Reserve System to control discount rates in the United States through the principle of re-discount for member banks of approved commercial paper. This power was not exercised during the war period because it was deemed wise to help government financing through the maintenance of a low interest rate. Furthermore, the gold reserves of the Federal Reserve Banks were comparatively strong, owing to the great influx of the precious metal from abroad, sent in payment of foreign purchases, chiefly in 1915, and the substitution of credit balances for money reserves in the member banks of the country. The conditions thus established, of course, were elements of inflation, particularly as the Federal Reserve Act provided for lessened reserves in the national banks.

Under normal international conditions the advance of the discount rate of a central bank tends to draw capital from foreign countries and offsets the necessity of gold exports. It tends generally to minimize bank loans and promote liquidation. The effect of this policy, as we have seen, is to promote the reduction of commodity prices. On the other hand, a reduction of the discount rate would tend to increase loans, tend to stimulate enterprise generally, and ultimately advance prices. The proper function of a central bank, or of a central board with corresponding power, is, of course, to stabilize prices so far as possible and to minimize the ups and downs of credit movements. Such movements, however, are more or less inevitable, growing out of the inherent errors in business life.

Recently, the rediscount rates of the various Federal Reserve Banks have been advanced. This action was followed by a tendency to curtail credit by the member banks, with the consequent reaction on the price fabric of the country. In general, therefore, it cannot be claimed that in this particular credit cycle, the Federal Reserve System has acted as a stabilizing element; but it is now functioning along approved lines, although somewhat late, and should prove to be an important factor in approximating an orderly decline in prices.

THE chief element which has caused our present inflation, our great government debt, is likely to remain a non-liquid element in our banking and currency fabric for some time to come. This suggests that a large amount of inflation may remain in our price schedules and only be eliminated as the debt is gradually paid or absorbed through the savings of the people. It will be remembered that prices following the Civil War, with some erratic exceptions, declined very gradually for a long period of years. The changes are shown in the following index:

1864—249	1872—153
1865—229 (Peace established)	1873—147
1866—206	1874—143
1867—192	1875—135
1868—186	1876—120
1869—170	1877—116
1870—155	1878—100
1871—152	1879—99

(Resumption of specie payments)

The business world has no guide to point to future price movements, or determine a sane reduction from year to year. Prices will brook no control—they look out for themselves and are really the governors on the machinery of business, if not interfered with by governmental price-fixing schemes or trade agreements. It is possible that price-fixing may be justified during a war period, but from an economic standpoint the price tendencies are stronger than the forces of governmental or trade regulations. Fixing prices during a decline would be very difficult, although theoretically possible under seasonal readjustments.

A merchandising concern that does an annual business of seventy-five millions of dollars has taken an attitude which emphasizes a seasonal basis of prices. It is announced that they have begun their spring buying in lines where the manufacturers have been able to standardize prices. It is pointed out that business and confidence must be re-established, and that it devolves upon the producer to set prices which he can stand by. The statement in part says:

“Labor must be kept employed; mills throughout the land must be heartened by real orders to set in motion wheels already stopped, and to speed up those that are running.

“No sane manufacturer will at this time make goods without orders; because, however carefully he figures, he would have to force the goods for sale if they did not move quickly, and pocket new losses.

“Prices are not done coming down, though some lines have struck the cellar, and must rebound a bit to reach a live-and-let-live basis. But a start must be made somewhere to re-establish business and confidence. The pessimist will create worse havoc if the optimist does not prevail over him.”

(To be concluded.)

(Special Correspondence to THE AMERICAN ARCHITECT)

SEATTLE—Stabilization of prices and conditions continues very favorably here. The steel market has invited the confidence of investors and builders during the past month. Architects report a more definite inquiry as to costs. Pencil sketches are rapidly multiplying. Lumber is acting sympathetically with steel, and is now on a new lower operating cost. Increased production by labor is chiefly to be credited.

With labor generally producing at normal capacity,

THE AMERICAN ARCHITECT

it is felt that the spring building season on the Pacific Coast will gradually improve.

Sheet metal is meeting the Steel Corporation levels, and there are sufficient stocks on hand for present or early spring requirements. The railways are now handling the bulk of the stock in transportation, intercostal water transportation having proved rather unsatisfactory. Pipe arrivals and deliveries are considerably improved. All sizes are available. The jobbing trade expresses the opinion that the situation is now satisfactory.

Seattle architects estimate this week that it will require an expenditure of \$125,000,000 to meet Pacific Coast building needs, and that \$50,000,000 spent on construction in this city alone would not overbuild it. Architects who are willing to go on record on this statement are firmly of the opinion that every essential item in the construction line is now at a reasonable basis, including labor. This city is three years behind in Class A office buildings. A number of old office buildings await remodeling to be brought to a modern revenue-producing level. There is also a great need for Class A apartment houses. Architects are recommending that this type of construction be henceforth six and ten stories in height, with most modern equipment and roof gardens. There is a great need for hotels, an auditorium, hospitals, a temple of music and more school buildings.

Methodists of this North Coast territory are gathering funds for a \$1,000,000 hospital, which they hope to build in this city within the next two years. Congress has been asked to appropriate \$1,000,000 for a new immigration station at Seattle, and owing to the urgent need for such a structure, it is believed here that the congressional budget will include an appropriation for it.

The "Own-Your-Home" campaign is on in Seattle this week. Posters are everywhere. Literature prepared by the Seattle Real Estate Association is being spread broadcast. Motion pictures are also being utilized in the campaign of publicity.

Fir lumber wholesalers are refusing to sell short on this market, indicating better confidence in futures than was shown during the last quarter of 1920. Reduced log and labor costs, it is conceded, will bring a recession in the market in big timbers used in railway construction, but will not be reflected in the building industry. Progress is being made in securing water rates intercostal for hauling Fir lumber tonnage into the Atlantic seaboard and southeastern territory, and with \$18 from Puget Sound to New York as competition, the railways announce that a rate of 95 cents per hundred pounds may be expected early in March. Should the overland lines name this figure, it is certain that water rates will decline still further, possibly to \$15 per 1,000 feet.

Average prices at which the Fir mills sold lumber

during the last week mill basis were \$49 for vertical grain, and \$23.50 to \$29 for slash grain flooring, \$62 for stepping, \$23 to \$28 for drop siding, \$15.50 for boards and shiplap, \$13.50 for dimension and \$18.50 for plank and small timbers. The mills are not accepting business on the present shingle price to the trade of \$1.85 to \$1.95 for stars, and \$2.10 to \$2.20 for clears, square-pack basis. The per thousand basis of quoting shingles will be permanently abolished when the mills resume the spring cutting.

(Special Correspondence to THE AMERICAN ARCHITECT)

CHICAGO—The work of last week's conference of lumber and building materials manufacturers showed practically no tangible results, and was summarized in two resolutions, the first calling upon building materials manufacturers to exert their best efforts for reductions in construction costs, the second suggesting that Congress be requested to direct its amendatory attention to those laws which interrupt the operation of natural economic laws, such as unscientific revenue acts, excess profits tax, excessive surtax on individual incomes, the Clayton anti-trust act and the Adamson law.

The public uncertainty as to building costs is at present blocking building, according to the opinions of the majority present. This is the big factor. One of the most important subordinate factors, as indicated by many of the speakers, is the reluctance of investors to take up mortgages when many tax-free investments offer much better returns. Tax exempted mortgages is one of the necessary steps in the building renaissance.

The conference looked upon the price problem as the big obstacle. This is the reason for public uncertainty, of course. There has been deflation in certain materials, but a great deal more in those materials, and in others, was held by the conference to be necessary to any sort of building program.

The meeting resolved itself finally into a general plea for everyone to get down as close to bedrock as it is now possible, so that public confidence may be secured.

Labor came in for its share of criticism, practically all present at the conference being distinctly of the opinion that the desire of the Chicago Building Trades Council to continue the \$1.25 hour for union building workmen for three years was wrong. It was held that labor must take its loss with the others, or else hold up the building program or invite an open shop fight.

Speaking again of public confidence, the discussion turned to advertising. The conspicuous example of the Northern Pine Association in its "public confidence" advertising campaign was referred to, as well as the action of the paint and varnish industry in its "Save the Surface" campaign. In line with

THE AMERICAN ARCHITECT

this policy of favorable publicity, the board of directors of the National Lumber Manufacturers' Association, the official host of the conference, decided to raise and spend a fund of \$300,000 to promote public confidence in building and to do away with the "unjustified prices" criticism.

Another important item in local building is the recent indictments brought against 46 millwork manufacturers, carpenter-contractors and union leaders, alleging that the 1918 agreement which prohibited Chicago union workmen from using non-union sash, door and blinds established a virtual monopoly by Chicago manufacturers on that line of business, the open shop towns outside Chicago standing no chance in competition. It is said that the arrangement added about \$3,000,000 to the annual rental bill of the city.

The manufacturers and carpenter-contractors hold that the agreement was really a war-time truce with union labor, and that they themselves would like to see the agreement abrogated.

Building here is waiting for a further shakedown in prices.

Lumber remains on fairly stable levels, with upward tendency.

Local quotations are as follows:

Yellow Pine:—B. & B. 1 in., \$95 to \$130; 13-16, 3¼ flat flooring, \$85 to \$90; 2 by 4, 10 to 16 feet, No. 1 long leaf, \$51; 2 x 6, \$48 to \$49; 2 x 8, \$49 to \$50; 2 by 10, \$52 to \$54; 2 by 12, \$54 and \$56.

Northern Hardwoods, carload lots, Chicago:

Birch, four ¼ No. 1 and 2, \$155; select, \$130 to \$138; No. 1 common, \$95 to \$100; No. 2 common, \$60 to \$65; No. 3, \$35 to \$40.

Hard Maple, four ¼ No. 1-2, \$135 to \$140; select, \$115 to \$120; No. 1 common, \$95 to \$100; No. 2, \$60 to \$65; No. 3, \$32 to \$50.

Red Gum, four ¼ No. 1 and 2, \$148 to \$152; No. 1 common, \$88 to \$92; No. 2, \$43 to \$47.

Birch, four ¼ No. 1 and 2, \$155 to \$160; select, \$130 to \$139; No. 1 common, \$95 to \$100; No. 2, \$60 to \$65; No. 3, \$35 to \$40.

Douglas Fir, 12 by 12, No. 1 up to 32 feet, \$65 to \$75; 14 by 14, \$68 to \$75; 16 by 16, \$70 to \$75; 18 by 18, \$75 to \$80.

Cement:—Universal, \$3; Lehigh, \$3.00; Portland, \$3.00.

Bulk lime, \$1.70 to \$1.90; face brick, octagons, \$68 to \$75; fire brick, \$32 to \$40; 12 in. .24 to .27, 18 in. .46 to .54.

Crushed stone gravel, \$3.40 to \$4; lake and bank sand-torpedo, \$3.40 to \$4.

(Special Correspondence to THE AMERICAN ARCHITECT)

BOSTON.—Unemployment continues, a recent survey of the organized workers of Massachusetts by the State Department of Labor and Industries showing that it affects more than one-quarter of the organized workers. Labor unions reported that out of a total membership of 199,022, the number of idle was 57,420. Inactivity in the boot and shoe industry is about 45 per cent. But conditions are *really* improving.

The strike of 30,000 building mechanics in Boston, which started this week, continues. It was stated at the headquarters of the Building Trades Employers' Association a few days ago that the employing contractors were seriously considering a reduction to 80 cents an hour, 10 cents below their former offer of 90 cents. It is the opinion of many architects and engineers that a reduction to 90 cents an hour is not sufficient to stimulate building.

In some sections and industries in New England, confidence is nevertheless returning. New Bedford, Fall River and other mill cities report an encouraging flow of orders. The textile situation has definitely turned for the better. Wool showed a rebound in prices, and the volume of business is decidedly better. Some shoe factories report operation of machines which have been idle for months.

Deflation has yet to make its mark on some other lines. It is reported that several of the independent steel corporations, for instance, have cut plates this week to \$4 a ton under the U. S. Steel's figure.

It is thus evident that the whole problem is one of adjusting prices in all industries to a common level, so that the products of one may be exchanged for those of another on a fair and equal basis.

55-

fruit piece to 16 235-5

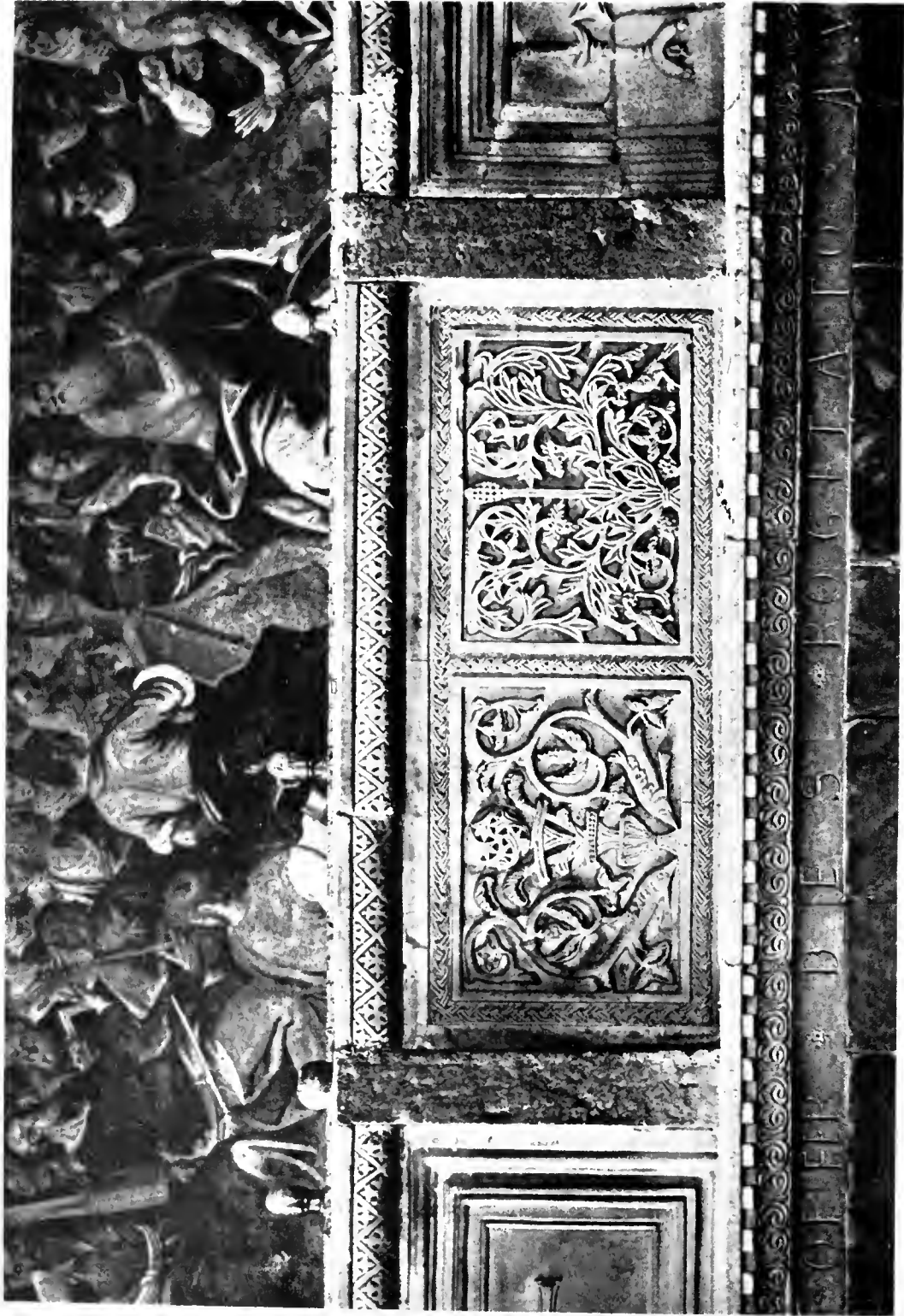

DETAIL OF GALLERY PARAPET, CHURCH OF S. MARK, VENICE

THE AMERICAN ARCHITECT

VOL. CXIX

WEDNESDAY, FEBRUARY 9, 1921

NUMBER 2355



PLATFORM
THE TOWN HALL, NEW YORK CITY
McKIM, MEAD & WHITE, ARCHITECTS

What Is the Industry Going to Do About It?

Pertinent Proceedings and Impressions of the New York District Conference
of the Building and Construction Industry, Held in New York City,
January 25, 1921

You who transform the trees of the forest into lumber for the building of homes; you, the workers in clay and the quarriers of stone; you, who mine, convert and work the metals used in construction; you, who buy and sell the products of the quarry, the pit, the mine, the forest, or manufacture them for sale in useful forms; you, who employ these products, as the artist uses his colors and brush, as the mediums for permanent concrete expression of your genius in design; you, who by the work of your hands or your skill in executive management, assemble and fabricate these products into buildings; and you, who control the flow of industry's life blood—capital and credit; all of you who, functioning together, constitute the building and construction

industry are called to take hold of your industry, lift it off the flat of its back and stand it on its feet that it may again go forward with increasing vigor in the service by which it lives and the community prospers.
—From the Program of Action.

AND you, having just read this declaration of purpose, are probably recalling, with a cynical sort of smile, similar phraseology in several such declarations which heralded other meetings of this nature in the immediate past and which have already sunk into an oblivion as complete and dis-

THE AMERICAN ARCHITECT

courageously thorough as that oblivion which today surrounds the details of Aztec civilization in Mexico.

But there is the exception to all things, and this, in the overworked program of that much abused "co-operation" which we are all only too anxious to secure, will very probably prove itself a notable exception. There will be no need for the cynical smile.

For this movement has already achieved both momentum and at least the beginnings of national importance. From August 6, 1920, when the idea of bringing *all* the elements of the building and construction into a common meeting was actually made concrete in the Atlantic City conference, there has been the gradual growth of momentum. It has taken root in Boston, New York, Pittsburgh, Chicago and St. Louis, where groups, representative of the whole local industry, are either organized or organizing to discuss industry problems and group policies as a preliminary to the first congress to be convened in the Spring of 1921.

The district conference in New York City was one of several which have already been held for the purpose of sounding sentiment on the matter and gathering whatever preliminary data on the subject may be now gotten together for the Spring congress of 1921.

THE BANKER'S ATTITUDE

The need for a congress such as this one, and for local district councils, was emphasized by all the speakers, but the fundamental and really significant need was best pointed out, not so much by what was actually said by two of the speakers as by a most important fact developed as the result of their addresses.

One of those addresses was made by Clarence Kelsey, first vice-president of the Title Guaranty & Trust Company of New York. It was, to our way of thinking, the most important address of the day, primarily because it came from a man in as important a financial position as Mr. Kelsey, and secondarily because it indicated the bankers' attitude on building construction in the highly important matter of credit. This is the first time, we believe, that the financial element (and we take Mr. Kelsey as representing a goodly portion of that element) has spoken so directly on a topic which has unfortunately been subjected to a silence second only to that of the Sphinx.

"There are three main factors in any construction undertaking," Mr. Kelsey began, "capital, material and labor, and an owner who has or will borrow the capital, invest it in the material and labor and look to the result for profit.

"Capital is the fundamental requisite. Without it, the next steps cannot be taken, but the procuring of

capital is only the first step and accomplishes nothing if the next two cannot be taken.

"The second will not be taken no matter what the prices for material and labor unless the third step is covered in the promise of a reward to the owner.

"In the State of New York, the rent profiteering laws have so far as housing is concerned practically blocked the way for production or encouragement in taking the third step. Those are temporary and will soon, I believe, either be repealed or disregarded, and at any rate, in a little more than a year, will have expired.

"The factors, therefore, for a great construction movement are a supply of capital and a supply of willing and faithful workmen and reasonable costs of material.

"There is no great difficulty in the matter of capital—not nearly as much as is generally supposed—at any rate so far as mortgage money is concerned. It is true that the income surtaxes have driven the large individual and estate mortgage lenders out of the market, but their place is being taken, in a measure, by small ones through the activities of the title insurance and mortgage companies, by their methods of cutting up the large mortgages into small pieces represented by certificates, sold to small investors. The institutions also are coming back into the market to some extent and making loans on their own account.

"With regard to the balance of the capital required to carry the equity, there is, I believe, greater difficulty, and that difficulty is involved to a considerable extent in the costs of labor and material. As long as these costs remain so high, it is evident that the builder or owner has to have a much larger amount of capital of his own than was formerly necessary, but neither the mortgage lender nor the owner is eager to proceed until the costs of labor and material come down. This, I believe, is the crucial point to be covered if we are considering a great construction development. It will not take place on the current scale of material costs or of labor cost and inefficiency.

"The recent exposures of the way material costs are kept up are very disheartening and it is a bold man who will proceed with an extensive building program until assured that these combinations are absolutely abandoned and that real competition in price can be secured. Neither will there be a great building movement until labor comes to its senses. I do not mean by this, necessarily, a great cut in wages, but I do mean a great change in what the laborer gives for his wages. I cannot understand that labor can be so blind as to believe that business can go on with ever increasing wages to labor and ever decreasing performance by labor.

"I have not much hope of a satisfactory change

THE AMERICAN ARCHITECT

in this respect until the fundamental principles of labor unions are reformed. The individual laborer is standing in his own light and dwarfing his future by consenting to them. How can the ambitious, industrious and thrifty mechanic expect to get ahead unless he is rewarded for his skill and efficiency? Until the labor unions permit classified lists, with graded pay or piece work or some other method by which the skilful can do better than the unskilful and lazy, labor is bound to be inefficient.

"The result of the present policy we see all about us. The more the employer pays to labor in dollars, the less he gets in service. We all know that this cannot last, that it is dishonest, and that nobody suffers from the failure so much as the employee. The whole thing travels in a circle and comes back to the laborer in the rent that he pays, in the price that he pays for everything that he buys.

"In my judgment, it is in the hands of the material men and the labor unions to correct the whole vicious situation which confronts us today and to start a construction program that shall give work and prosperity to all. Decreasing continually the brick that a mason can lay, or the plastering that a plasterer can put on, or the lath that one can affix, the more his wages go up, means but one thing—just what we see all about us.

"The problems stated in the program of this association that are crucial to its purposes are plainly

stated and can be easily solved if there is the real and sincere will to do it.

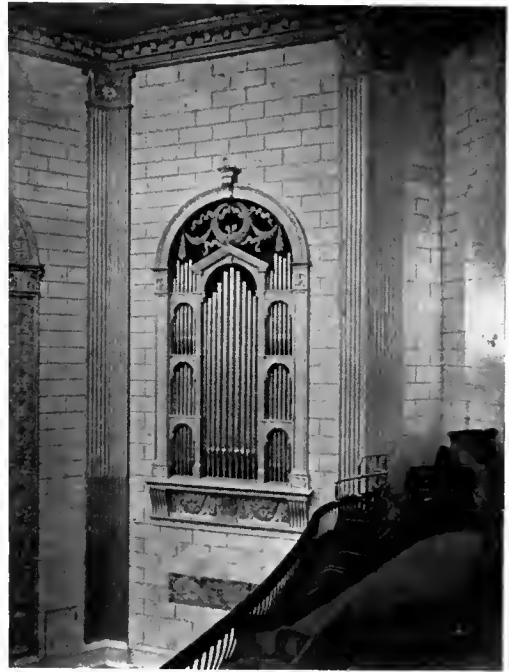

ORGAN DETAIL

THE TOWN HALL, NEW YORK CITY
McKIM, MEAD & WHITE, ARCHITECTS

"The first is, how can an adequate supply of skilled craftsmen be provided? The answer is by giving the skilled craftsman a chance to do better than the veriest slob at his trade.

"How shall the proper functions of the respective elements be defined? By each one putting an honest price on his wares or on his labor and honestly competing to get a job by fixing his price right and making his services efficient.

REASONABLE AND ABUNDANT CREDIT

"How can abundant credit resources be made available at a reasonable cost? By presenting for security to the mortgage lender a property built with honest labor, and material honestly priced, and so far as the bank credits to the builder are concerned, by convincing the banks that the job is one honestly conducted and that the owner's money is not to be wasted on material bought under the conditions of dishonest and unlawful combinations in price, and with labor honestly endeavoring to earn the money that is paid to it. The



VIEW FROM LOWER FLOOR
THE TOWN HALL, NEW YORK CITY
McKIM, MEAD & WHITE, ARCHITECTS

THE AMERICAN ARCHITECT

banks will not lend to builders or material-men if present conditions continue and they see that so much money is wasted on the job that it never can pay. They do not wish to lend to an owner whose undertaking is bound to be a failure because he is robbed in the construction of his building."



THE TOWN HALL, NEW YORK CITY
McKIM, MEAD & WHITE, ARCHITECTS

Mr. Kelsey was subjected to an unusual amount of cross-questioning after his address. This came from not only some of the labor leaders present, but from others as well. On practically every matter affecting labor about which he had anything to say [notably the statement that certain mechanics were limited to a fixed daily production by the unions or some other element] he prefixed his answers by the words, "I am informed," or "I believe."

These words were taken by Hugh Frayne, general organizer of the American Federation of Labor, in charge of the New York office, and formerly a member of the War Industries Board, as the keynote of his address.

"The best argument put forward here for a congress such as this one," Mr. Frayne emphasized at the very beginning of his remarks, "was Mr. Kelsey's speech."

There was a noticeable gasp at this statement.

"His ignorance of labor conditions," Mr. Frayne continued, "emphasizes the need for just such a gathering and just such a congress as this gathering proposes. He tells you that he is informed of the existence of certain conditions. Now, we are all informed of almost everything, but there are degrees of being informed.

"He tells you that he 'understands there exists' or is 'informed' of certain malpractices, among which is the arbitrary reduction of individual daily production by certain agencies, just what he does not know. Let me say that in my long experience with both employers and employee, with the man who hires and the man who is hired, I have never known of any organization going on record, or of any law intended to limit the amount of work any individual may do in a day or week or month. No one is more opposed to the man who isn't willing to give service than I, but I do not believe it fair to charge labor as a whole with inefficiency because of isolated cases. I admit that such cases exist, but they are comparatively insignificant in numbers.

"I don't say that we have all the good people in labor, but I do deny that we have all the bad ones. I speak as a mechanic, who has worked with his hands and has had experience in handling men on many construction jobs. I know the elements that enter into individual production, or group production. Various factors, such as weather, enter into the problem of production; and no one can arbitrarily set a daily standard for production, because no one

is powerful enough to remove the factors which naturally increase or decrease such production from day to day."

Speaking of the so-called "war record" of labor, Mr. Frayne said:

"We have heard all sorts of talk about the inefficiency and high pay of labor during the war, and it is most unfair talk. What happened at that time? The shipyards illustrate it vividly. The Government

THE AMERICAN ARCHITECT

and private corporations were forced to get men and get them quickly, and as a result they took them wherever they could find them. A young fellow, accustomed, let us say, to stenography, went into the shipyards to work. His reaction to his surroundings—the noise, the dirt, and even those with whom he worked—was psychologically horrible, and as a result, that young fellow could *not possibly* produce efficiently. He wasn't trained, he wasn't accustomed to the work, and he didn't like it. He could be nothing but an inefficient worker.

"There were thousands like him. Their combined efforts produced astounding inefficiency. And who suffered most?

"The trained worker, of course. He was used to the work, knew his trade, and liked it, and he was *producing*. But he was arbitrarily dumped into a general rating-pot, with the newcomers [necessarily inefficient] and his efficiency rating was based on the *total man power*, instead of the *trained man power*."

Mr. Frayne then discussed the moral responsibility of employers toward the men they hire, and emphasized the fact that in all discussions and all the

trained when hired or was trained after being hired.

"What's wrong?" he asked. "Is labor getting too much pay? Is production low? Is labor failing to do its full duty?"

"Wages are not too high. The price of almost every commodity went up before wages, and that



ENTRANCE DETAIL
THE TOWN HALL, NEW YORK CITY
McKIM, MEAD & WHITE, ARCHITECTS



ENTRANCE DETAIL
THE TOWN HALL, NEW YORK CITY
McKIM, MEAD & WHITE, ARCHITECTS

talk about labor the human element has been completely lost sight of. He maintained that it was the duty of the employer, when he hired a man to work for him, to see to it that that man was either

increase had to be, and was met by increased wages. We are not going back to pre-war standards.

"We are part of an industry upon whose well-being the livelihood of millions of workers depends, and we are looking here for some remedy to an appalling situation.

BETTER SYSTEM OF TRAINING NEEDED

"The remedy is simple enough. Keep in mind always the human equation. There you have it. More specifically, see to it that a better system of training for the workers of the industry is brought about. Pick trained men when you hire them, or train them. I am for this conference, heart and soul as many architects and engineers here can tell you. I have always believed in agreements between employer and employee. I have sat down and talked things over with some of the men in this room, and they were all employers of labor. I have found that when they knew our side of the case, from first hand, when they had facts, and not gossip, at their command, they always treated us fairly.

THE AMERICAN ARCHITECT

"I am satisfied that this is a great step forward, for it brings all the elements of the industry together. And *all* the elements have never before been brought together. Mark that statement.

"This is a big thing, and I am for it, personally and officially, and I can assure you that co-operation of the sort intended here will do more to clear the situation and put the building industry back on its feet than any other factor.

"Let me add this. There are thousands upon thousands of trained and skilled craftsmen and workers in the building industry, and *they* can find work. If you employers in New York co-operate with them, they will work for you and work well for you. But if you don't co-operate, if you don't show some intention of laying your cards on the table, they'll go elsewhere to work. And there is work to be had elsewhere, gentlemen.

"As for labor, I want to say right here that we will lay our cards on the table, face up and in full view of whoever may wish to look at them. I promise you that."

These two addresses sum up the spirit and essence and possibilities of this conference better than anything else that was said, because they come authoritatively from two of the most vital factors in any building program, and because they represent the official attitude of those factors.

MR. KOHN OPENS THE DISCUSSION

The morning session of the conference was given over to five addresses, two of which were of undoubted importance to architects. One was Mr. Frayne's, the other that of Robert D. Kohn. Mr. Kohn took no pains whatsoever to spare the feelings of other architects present, and his remarks, at the opening of the session, were made doubly important in view of his personal and particular importance in this movement and in the profession of architecture.

"I am ashamed of the industry of which I am a part," he said, "I am ashamed of what I myself may have done in that industry. I know nothing about this great industry as a whole. I don't know why materials fluctuate as they do, why men come into the building industry and leave it, how many do so, what controls material prices, and why there isn't any money to be had for the second greatest industry in America.

"I recognize as one of the fundamental difficulties that there is a shortage of skilled labor, due, as I see it, to competitive bidding between employers for that labor. This was especially true during the war period. . . .

"The problems before us are reduceable to one, and that problem is how best to get at facts and secure co-operation. I confess that architects have

been of the 'stand-offish' sort for too long a period, but they have come to the point today where they realize that they are an integral part of the industry. . . .

"We are not here to argue over matters, or to discuss the open shop or any other factors having to do with that phase of the labor situation. We don't care about the open shop, and we don't want to hear about it. We do want to conduct a scientific investigation into five things, as I see it. One is the supply of labor. The second has to do with those reasons which impel men to come into this industry and work in it, whether they be architects, craftsmen or bricklayers. The motive may be simple enough, but what authoritative data have we regarding the labor turnover in the building industry, and all such factors? We want to find out just how important the architect is or should be in this great industry, and why he is *actually* that important. We want to find out about materials. And we shall hear something today about finance.

"The second largest industry in the United States is helpless today, because there is a lack of co-operation. That is a ridiculous situation. An industry in which at least 15,000,000, perhaps 20,000,000 people are engaged, finds itself on its back, unable to get up and stand on its feet. Due to finance? Well, it seems to me that the millions engaged in this industry can create their own credits, quite independent of banks and trust companies. That may be far fetched, and probably is, but it points a solution.

"We are here to determine the need for a national movement, for a local group, and the field of activities."

W. G. Luce, of Hegeman-Harris Company, representing the contractors, then emphasized what Mr. Kohn had said regarding co-operation, pointing out that at a dinner in Philadelphia, similar in purpose to this conference, the Executive Committee of the American Federation of Labor had this to say regarding the movement and the Congress idea:

"The architect has been way up in the sky for a long time, and we never felt that we could get to him. If he comes into this thing, as he has here and will do so in other places, we will be just fifteen years ahead of the game, because the presence of the architect at gatherings like these indicates a genuine desire to get down to brass tacks and do something."

Mr. Luce referred to a conversation he had with one of the associate editors of this journal on the previous day, in which the editor told him that the housing problem had reached the point of a national crisis (strikingly similar to the war) and that co-operation such as the war brought forth among every industrial element of the nation should now show its hand on the same basis.

"I thought that over last night," Mr. Luce said,

THE AMERICAN ARCHITECT

"and that fellow was right. This is a national crisis, and we need co-operation of the sort we showed during the war."

TEN CONCRETE THINGS TO BE DONE

The afternoon session was given to several addresses and a great deal of discussion, but the most important and vital of them all, from the standpoint of the architect (in that it provided ten more or less concrete things which the local councils and national congress may actually get under way immediately) was the short address by Louis K. Comstock, of L. K. Comstock & Company, which presented the point of view of the sub-contractor in the situation.

"Business men today don't know where they stand under the law," Mr. Comstock stated emphatically. "There is no machinery for finding out in advance if you're going to violate the law or not. We need that, to begin with, and this local group can contribute its share of such information to the national body.

"We need a code of practice. Not a Hettrick code, but a code based on the old English Law of Merchant. We need a machinery to enforce that code. . . .

"We need a great many things, but here are ten which I believe we can get at in this national congress this spring; and these things are justification enough for this and similar meetings which have taken place or will take place in other cities.

"The Congress can:

1. Improve the facilities of the building industry;
2. Standardize documents and laws affecting the building industry;
3. Secure harmony of action on questions affecting materials, finance, and credits;
4. Safeguard the building industry against waste and fraud;
5. Increase total production in the building industry by elimination of waste effort;
6. Work for trade regulations and legislative increases which will facilitate and encourage the development of the economic side of the building industry.
7. Centralize data concerning the technical and economic features of the building industry;
8. Inform and create public opinion, through publication of facts regarding conditions in the building industry and through the dissemination of views of technical experts and business men;
9. Cultivate personal acquaintanceship among builders, architects, engineers, and contractors in order to lessen group and sectional prejudices and misunderstandings;
10. Promote peaceful progress, cordial relationships and co-operation among individuals of the industry.

"These are the things," Mr. Comstock concluded, "that we can investigate now; these are some of the things that demand correlation of facts; and these are the sorts of problems which this congress will be fully prepared to deal with *accurately* and *effectively* if local groups, such as this one, do their full share toward contributing their co-operation in the general scheme of action."

RESOLUTION ADOPTED

A resolution designed to give continuity to the conference and permanence to its work was introduced by H. C. Turner, and unanimously adopted. The resolution read as follows:

WHEREAS it is the conviction of this New York District Conference that a National Congress of the Building and Construction Industry, in which there will be represented every functional element of the industry, is the indispensable instrumentality for the needed co-ordination of the industry to the end that the industry may progressively raise the standard of quality and the extent of its services to the public; and

WHEREAS the National Congress, to be successful, must result from a local demand for it arising from an understanding of the constructive value of the contacts and frank discussion which are possible only locally; and

WHEREAS, the National Congress can be given continuity only by reason of continuous local contacts and discussion, be it

RESOLVED, That a permanent conference of the Building and Construction Industry in the New York District be created; and be it further

RESOLVED, That to the end that such a permanent conference be created, that an organizing committee be appointed consisting of two architects, two general contractors, two sub-contractors, two labor representatives, two manufacturers, two dealers, two financiers and two engineers, together with such others as will make the committee representative of every interest and element in the industry in the New York District to prepare a program providing for the creation of a permanent conference of the Building and Construction Industry in the New York District.

Further discussion of routine matters followed this introduction, after which adjournment was declared by the chairman, Mr. Kohn, until the organizing committee should be ready to report.

BIRTH AND DEVELOPMENT OF THE CONGRESS IDEA

Sullivan Jones, who acted as chairman of the morning session, and who is temporary secretary of the movement at present, explained the idea of the congress. Mr. Jones has been one of the most active members of the Executive Board of the Congress.

"To get at the facts," Mr. Jones explained, "to establish the basis for common action and understanding upon common interests, the idea of a permanent congress of the several elements in the industry was evolved at a conference in Atlantic City on August 6, 1920, which was attended by representative architects, contractors, sub-contractors, engineers, manufacturers of building materials and labor men. This conference appointed a Congress Organizing Committee, which met in Chicago on September 27th, and that committee declared the National Congress of the Building and Construction Industry created, to bring together in co-operation every element contributing towards or concerned in the building industry in a movement intended to promote the efficiency and improve the quality and extent of the service rendered for the public good by that industry. It was resolved that a thorough

THE AMERICAN ARCHITECT

study be made of the relations of the various elements and industries which enter into building and construction activities, that a congress be convened as soon as practicable to consider the ways and means of eliminating the various factors which have retarded necessary building and construction, and that a building and construction congress be permanently

tion. The congress should not be regarded as an organization, but as an institution. It is to be a deliberative body or forum without mandatory powers. For its own enlightenment it may, if it so decides, create and direct or employ research agencies. And to give its effort continuity it may set up executive machinery.



VIEW FROM THE PLATFORM
THE TOWN HALL, NEW YORK CITY
McKIM, MEAD & WHITE, ARCHITECTS

established to give continuity to the national beneficial objects which gave it birth.

"The committee then appointed a Congress Executive Committee which met in Pittsburgh on October 29th and reorganized itself into an Executive Board of forty to be composed of five representatives from each of the following elements of the industry: general contractors, sub-contractors, architects, engineers, manufacturers and distributors of materials and equipment, labor and investment capital.

FUNCTION OF THE CONGRESS

"The purpose, as expressed by the Executive Board, is not to create another national organiza-

"The driving power behind the movement is the fervent hope that the congress may become a brain for the building and construction industry; that it may become an instrument for securing facts, for thinking in terms of facts, and for planning the future course of the whole industry as a unified, frictionless, productive mechanism. But there is no thought that the congress should usurp or infringe the prerogatives of, or limit the autonomy of any existing organization."

Some of the men thus far identified with the movement are:

General Contractors—W. G. Luce, F. G. Webber, A. P. Greensfelder, Otto M. Eidlitz.

THE AMERICAN ARCHITECT

Sub-Contractors—L. K. Comstock, Oscar A. Reum, Frank W. Howard, Ronald Taylor.

Engineers—Morris Knowles, F. C. Shenehon, F. A. Burdett.

Architects—Robert D. Kohn, M. B. Medary, Jr., E. J. Russell, S. W. Jones.

Labor—T. R. Preece, James P. Noonan, John H. Donlin, George F. Hedrick.

Manufacturers—Wharton Clay, W. L. Hodskin, O. Spear.

Investment Bankers—Walter Stabler.

amount of projected work is released? In the future, how shall the industry escape the effects of both under-production and over-production?

How is an adequate supply of skilled craftsmen in the several trades to be provided and maintained?

How is genuinely co-operative effort by employers and wage earners (whether the wage earners are organized or unorganized) to be substituted for the



GENERAL VIEW OF INTERIOR
THE TOWN HALL, NEW YORK CITY
McKIM, MEAD & WHITE, ARCHITECTS

The first congress is to be convened early in 1921. This first congress will be composed of fifteen delegates from each of the named elements of the industry.

SOME OF THE PROBLEMS DEMANDING CONSIDERATION

Among the problems which the first congress will probably consider, the Executive Committee mentions the following:

How is the industry to prepare itself to meet the demand for structural materials; a demand now potential, but which will become real when the vast

antagonism which, in the past, has checked production?

How shall abundant credit resources be made available, at reasonable cost, to the industry in order that it may function in satisfying public need?

How shall the industry be led to adopt a uniform and equitable policy in bidding and with respect to contract terms and conditions?

How shall the industry be led to adopt a uniform of the respective elements of the industry be defined, and how shall performance be assured in order that maximum efficiency may be attained?

Quite a program!

A Street in Newport

(See reproduction of original drawing by O. R. Eggers on opposite page)

There is nothing in the view of this quaint, winding street, so picturesquely shown by Mr. Eggers, to suggest that it is a close neighbor to a section renowned all over the world for its palatial residences and the homes of multi-millionaires.

The native population of Newport, with commendable regard for the traditions which surround this town, have kept as far as possible free from incursions of modernism. The artist in drawing this picture has presented a street in the old town of Newport as it probably looked a century ago.

One may almost with accuracy trace the successive stages of building. Undoubtedly the houses, with their gambreled gables facing on to the street, were the earliest types. In the distance rises the spire of Trinity Church, shown in an earlier illustration. There are many well designed historic buildings in Newport. The neighborhood has long been a favorite sketching ground.

The State House, illustrated in an earlier issue, and in which is hung the original portrait of Washington by Gilbert Stuart, the old market house, dating from 1703, the Redwood Library and the Jewish Synagogue are among those best known.



A STREET, NEWPORT, RHODE ISLAND
THE AMERICAN ARCHITECT Series of Early American Architecture





American Architecture

IN this column the idea of regional and indigenous architecture has been discussed frequently. In a country which embraces such a diversity of climate, topography and structural materials as the United States, this is but a natural consequence and these regional types are being developed gradually. The ultimate center of population, culture and wealth will embrace a vast territory. The natural resources, topography and climate will not be so diversified but that a great regional and indigenous architecture will be evolved. By mere preponderance of numbers and extent this may become *the* American architecture and the other types become regional. Be this as it may, the entire subject is one for interesting speculation.

The attitude of the architectural schools will have a powerful influence and indications justify the opinion that the educators are now busily taking stock, to use a phrase from the article entitled "Westward Ho!" on another page, with the endeavor to place architectural education on the new basis that conditions demand. To aid them in this, the profession should lend its assistance and in doing so lay aside intolerance and prejudice, approaching the subject with an open mind.

THE AMERICAN ARCHITECT has maintained the idea that the practice of architecture is a business as well as an art and profession. In the new scheme for architectural education these two components must be recognized, each in its proper proportion. Shall these matters be adjusted as the result of demands or will they be established in leadership? There need be no ruthless tearing down of old idols and the institution of new gods, but rather a revaluation of the stock in hand which will naturally cause the development of new ideas and possibly an American architecture through the eternal force of evolution, quickened by the fast changing conditions of this day. Education of today influences the architecture of the morrow and we must unselfishly prepare for the architectural future in which we can

have no participation except through the influence of our works of this day. The educational scheme of today must be predicated on the suppositional needs of the future and these can only be established by free, open and unbiased discussion. Professional thought cannot be directed toward a more worthy subject.

Ethics in Architectural Design

THAT men retain an architect to design their buildings is a confession that they themselves know little of architecture. That they engage interior decorators is further proof that art holds aloof from them shrouded in a haze of misunderstanding.

What is the mental process of the architect or the decorator when a client first consults him? Where does sincerity enter into his calculations in conforming to the wishes of the client?

Should an architect or a decorator express the client's individuality even if the result be artistically bad, or should he express his own properly developed sense of art though it may not represent the client. Shall he descend to a French rococo house for the prim spinster who has inherited a fortune but knows nothing of art, or may he build a pure Georgian for the artistically ignorant butcher. Shall he design an inferior house to represent an inferior person, or shall he make it possible for an artistically ignorant man to pose as a connoisseur by means of a few well learned phrases about the beauty with which an architect or a decorator may have surrounded him?

These questions sooner or later force themselves upon every architect.

The very fact that an architect is retained presupposes a certain amount of *carte blanche* for him. The chances are that if he is tactful he can prevail upon a client to modify his preconceptions. Hence the importance of his influence and the need for his having a point of view.

An architect is a professional man who by education and training has a certain public responsibility to bear. He must uphold the dignity and beauty of architecture, and through it the dignity and beauty

THE AMERICAN ARCHITECT

of human beings. He cannot assume that certain persons are inferior. It is up to him to do his part to keep them at the level of their best moments. A man's intercourse with an architect may be the one contact of a lifetime with art. If architects are to do their full duty to raise the standards of living, they can find ample opportunity in their intercourse with prospective clients, to teach them the whys and the wherefores of good architecture, and make it something to be respected and loved, and then logically followed. While to adapt the architecture to the type of owner is considerably simpler than to adapt the owner to the type of architecture, it is desirable to do this in cases where it seems possible to develop the owner. Instead of building down to the level of the inartistic butcher, give him the sort of house that he must live up to. If he is surrounded with certain refinements in his home, these will inevitably tell, for environment is more powerful than we suspect. By going into the elements of architectural design with a client, it is possible either to teach him, or to convince him that your experience and advice is the thing he has sought.

If the artistically ignorant man poses in his new home, the very fact that he acts the artist gradually tends to give him the artist point of view. One cannot pretend to appreciate a thing without soon really appreciating it.

It is, of course, fortunate when a client sincerely yearns for good architecture and is willing to defer to his architect for most of the details. But such clients are rare and hard to find. It is infinitely more to the credit of an architect to succeed when all the circumstances are trying and difficult; when the client is perverse, the money scarce, and all the rest. In the building of homes, architects do more to conserve and promote the happiness and well-being of communities than can be readily conceived. When they do it without co-operation, when they turn antagonism into harmony, when they raise vulgarity to refinement, then, indeed, have they done a great work.

Reducing Transportation Tangles

THERE is nothing which will further reduce the cost of building than effective transportation of materials. This statement is based upon the supposition of fixed prices for fixed periods, of course. There is nothing that will better speed the building program of this nation than efficient transportation.

It is therefore the important duty of every architect to be familiar with transportation. Architects, as a whole, realize this. And nothing is of more importance in this problem at the present moment than the Esch-Cummins law and its effects. It may be

shown that it works injury, and that it was actuated by motives not entirely of a constructive nature, yet the fact remains that 1920 was the record railroad year for a nation whose railroads have most certainly been the "standard of the world" from the standpoint of efficiency. These achievements of the year were achievements in every sense of the word. In the nine full months (only nine months in which to recover from government control) since the Government turned back the railroads to their owners on March 1, the railroad companies under private operation have:

"1. Increased the average movement per freight car per day 6.3 miles—from 22.3 to 28.6 miles.

"2. Increased the average load per car 1.7 tons—from 28.3 to 30 tons.

"3. Made substantial reduction in the number of unserviceable locomotives.

"4. Reduced the accumulation of loaded but unmoved freight cars from 103,237 on March 1, to 21,991 on December 3, of which only 6,386 were detained because of the inability of the railroads to move them.

"5. Relocated approximately 180,000 box cars from the East to the West for the movement of farm produce.

"6. Relocated approximately 180,000 open top cars from the West to the East to keep up the production of coal.

"7. Moved the third highest coal production in the history of the country.

"8. Spent over \$500,000,000 extra on improving the maintenance of tracks, bridges, cars and locomotives.

"9. Contracted to spend about \$250,000,000, largely out of earnings for additions and betterments to promote the movement of cars.

"10. Made arrangements to purchase approximately 50,000 new freight cars, 1,500 new locomotives and 1,000 new passenger cars.

"11. Begun the reconstruction of thousands of old cars.

"12. Moved—with a deteriorated plant, under disturbed labor and business conditions—the largest volume of traffic ever known in a single year, with the highest efficiency yet achieved, and with a minimum addition to the value of the property on which the public has to pay a return through rates."

Such a record is one of which to be proud. It shows efficiency. It shows a splendid grasp of the railroad problem by the men whose business it is to keep those roads running. It indicates what can be done in 1921 if the brains of the railroad companies really get into the full swing of efficient reconstruction and recovery.

Westward - Ho!

FOOD and shelter are the two essentials for human existence. The first is universal; the latter varies with the latitude. The one concerns agriculturists, fisher-folk and stockmen; the other, architects. All shelter involves architecture whether it consists of caves or structures made of assembled parts; therefore, architecture is essential to human existence. Architecture, being the art of constructing buildings, varies with the latitude primarily and with the civilization of the people secondarily.

A civilization can be accurately gauged by its food and its architecture. Related indications are too numerous and varied for present discussion. The highest degree of civilization is that whose architecture has the correct relation between utility and beauty; the kind, preparations and manner of consuming its food is also a certain indication. The hut of the aborigines may contain all of the utilities that they require but in them we, at least, find no evidences of beauty or the conveniences of civilization. The richly decorated tent of the wandering Bedouin possesses beauty of color and texture but, like the aboriginal hut, lacks in comparative utility or conveniences. And so it goes, until we enter the XIX century when utility and beauty approach a parity. At the present time utility is probably in the lead due to the predominance of commercialized industry. To make a parity there must be an increase of beauty.

In *Harper's Magazine* for January, Mr. W. L. George makes this statement: "The civilization that the Middle West creates within the next fifty years will be the American civilization." The certainty of this prophecy can be demonstrated. The civilized world today is taking stock and everything therein is invoiced and the evaluation will be carefully considered. What, then, of architecture? Will it as one of the two essentials to human existence be in its rightfully dominant position with food or will it find collocation in parity with less essential things?

Architecture is either quick or dead. There can be no in-between existence. What, then, is that architecture which can be called "quick"? In taking stock, this must be determined, as "dead" commodities are not an asset. "Quick" architecture can only result from the efforts of a creative instinct. This instinct must be the underlying motif of architecture. It seems that the written words of that beloved Old Roman of Western Architects, Irving K. Pond, state the fundamental principle:

"Man has been struggling upward throughout the ages, struggling to attain the ideal. By this struggle, conscious as it has been, and with definite purpose, he

is marked as of an order higher than the beasts, which struggle for existence impelled by habit and guided by instinct only. Habit is life in the beast's creation; but habit in man has been aptly denominated the soul's tomb. In reviewing the struggles and achievements of man it will become apparent that habit builds the tomb of art; that when the spirit no longer inspires, but forms are repeated from mere habit and for form's sake, art has ceased to live and architecture reared in her name is her tomb."

Habits of the right kind which control personal conduct are desirable and necessary and so is rational thinking. Can live architecture result from the habit of designing from the great volumes which illustrate the works of Good, Bad and Indifferent, or Brown, Black and White, copied largely from the old masters; or will it result from hard work actuated by a creative instinct? Is American architecture a dull habit or a live, potent actuality?

Good architecture will live through the ages only in its native environment. It cannot be transplanted to other lands, peoples and amid strange ideals, without depreciation. The same is true of Sumatra wrappers grown in Connecticut. The good architecture of the past should be acknowledged, appreciated and absorbed and it will be reincarnated only through the inspiration and culture it yields to a creative spirit.

In Washington and other cities there have been erected imposing structures consisting of correctly proportioned basement, colonnade and entablature, duplicates of those erected by the ancients for an entirely different purpose and relationship to the building itself. Was this designing the result of habit or a frank acknowledgment of inability to treat those great bulks of structures as wall surfaces enclosing a building? It was obviously the most easy thing to do.

Nearly three decades ago a great exposition was constructed on the shores of Lake Michigan and it had a pronounced influence on American architecture. The classic school was the one more in vogue, one example of Spanish and one which might be called American architecture. Recalling those days, the impression of the Corinthian water gate and peristyle and the agricultural building is that of a dead age, ruins, a tomb. Perhaps the old illustrated books of history and foreign travel which showed ruins consisting of a few standing columns with entablature and pediment in part connected with the impression of ruins with the peristyle.

The administration building, with its great dome designed in a French style, did not fit either to the classic Watergate and peristyle or the low extensive buildings adjacent. All these white buildings against

THE AMERICAN ARCHITECT

the cold blue lake give a sense of chill and departed glory.

But turn from the setting sun, standing on the bridge over the lagoon to face the great golden western door of Sullivan's Transportation building. One stood still and looked with sheer delight at the prospect. That great door with its marvelous arch so richly and delicately ornamented, so beautifully colored, was a living, vibrant, pulsating thing and alive. It stirred all the senses, reacting through those beautifully chaste and splendid Muses of poetry, painting and music. Face then the West and through the golden dusk of the Midway behold—

"Gamboge and gold, broad sunset colors strewed
The purple west as if, with God imbued,
Her mighty palette Nature there laid down."

Architecture, the quick and the dead!

Of that American civilization developed in the Middle West an American architecture will be a concomitant. A starting has been made, the influence of which is becoming more discernible as time passes and prejudices are broken down. The burden of its development does in truth seem to rest with the Mid-west universities and architects. They will be equal to the demand, imbued with the spirit of that great empire, the Valley of Democracy through which flows the Father of Waters.—A. L.

Are You a Trained Observer?

THERE is a world of difference between casual observation and systematic, purposeful observation. A careful scientific observer can learn more in a few months about a given subject than the average man learns in a lifetime about it. The difference lies mainly in two factors: (1) the relative concentration of attention, and (2) the analysis and comparison of data.

Mr. Ernest Coxhead, of San Francisco, has written on "Training the Architect by Direct Method." One of his most suggestive statements was this:

"The power to visualize architecture is not to be developed to any extent merely by seeing things, or by gaining fleeting impressions, but by observation, focused and concentrated upon the object in general, and in detail, by actual contact with the building and by means of measured drawings and sketches and notes, further impressing upon the mind the observations made. The essence of the direct method then lies in taking the student to architecture and confronting him with it in three dimensions, life-size, as opposed to the atelier method of focusing his attention upon mere documentary representation of the actual building. In the latter case his sense of scale is undeveloped, his ideas of proportion remain distorted, and, by laborious mental effort, he sometimes is able to construct in his mind from the documentary study of plan, elevation, and section what the subject of study, or something akin to it, is in the reality."

Mr. Coxhead is emphasizing the "direct method," or the "field work method," of training architects, with particular reference to developing a sense of proportion. We quote him, however, for another

purpose, namely, to emphasize the value of "observation, focused and concentrated upon the subject."

When an engineer is asked to state his experience in a given field we are all prone to give undue weight to the number of years of his experience. Rarely do we undertake to measure the degree of his concentration of observation during those years. Yet without concentration of observation, mere personal presence among suitable surroundings adds little to any man's knowledge. During the last 200 years men have learned more about natural laws than during all the countless centuries before, not because modern man has a better brain than his ancestors, but because he has employed better methods of studying nature. In like manner a well trained young engineer may learn more in ten years than an ill trained engineer has learned in fifty.

More and more do educators realize that their main functions are, first, to arouse ambition, and, second, to instill lasting habits of carefully observing, reading and reasoning. It seems to us that engineering societies should also endeavor to strengthen such habits. To this end it will be wise to have classes in scientific observing, classes in systematic reading, classes in memorizing, and classes in logic. Call them classes in applied psychology, if you please, to differentiate them from classes whose main object it is to impart information rather than to develop mental habits.

It does not suffice to know what to do and how to do it. Men must be habituated by long practice, usually under mental trainers, to act in accordance with the principles to which they readily give lip service.

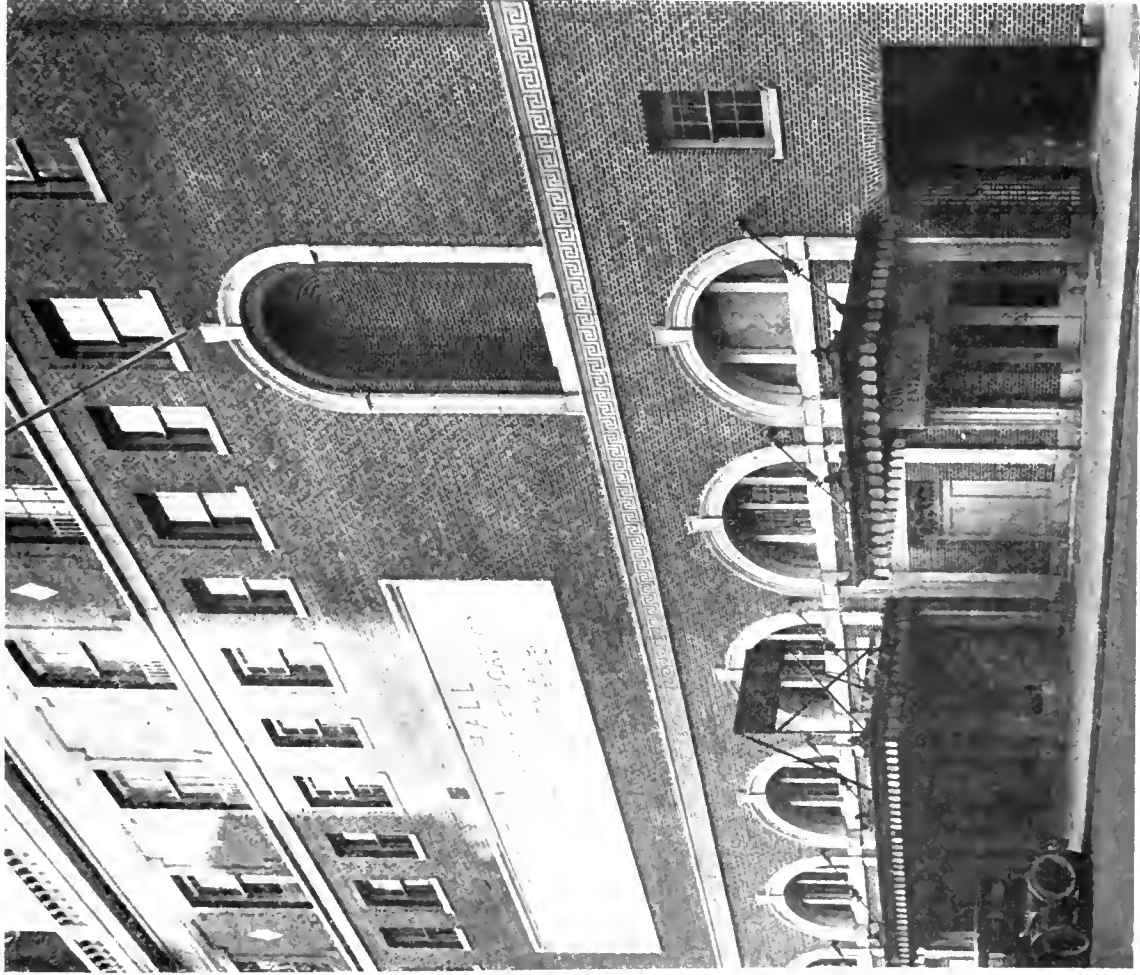

THE TOWN HALL, NEW YORK CITY
McKIM, MEAD & WHITE, ARCHITECTS



VIEW OF LOBBY



ENTRANCE TO AUDITORIUM

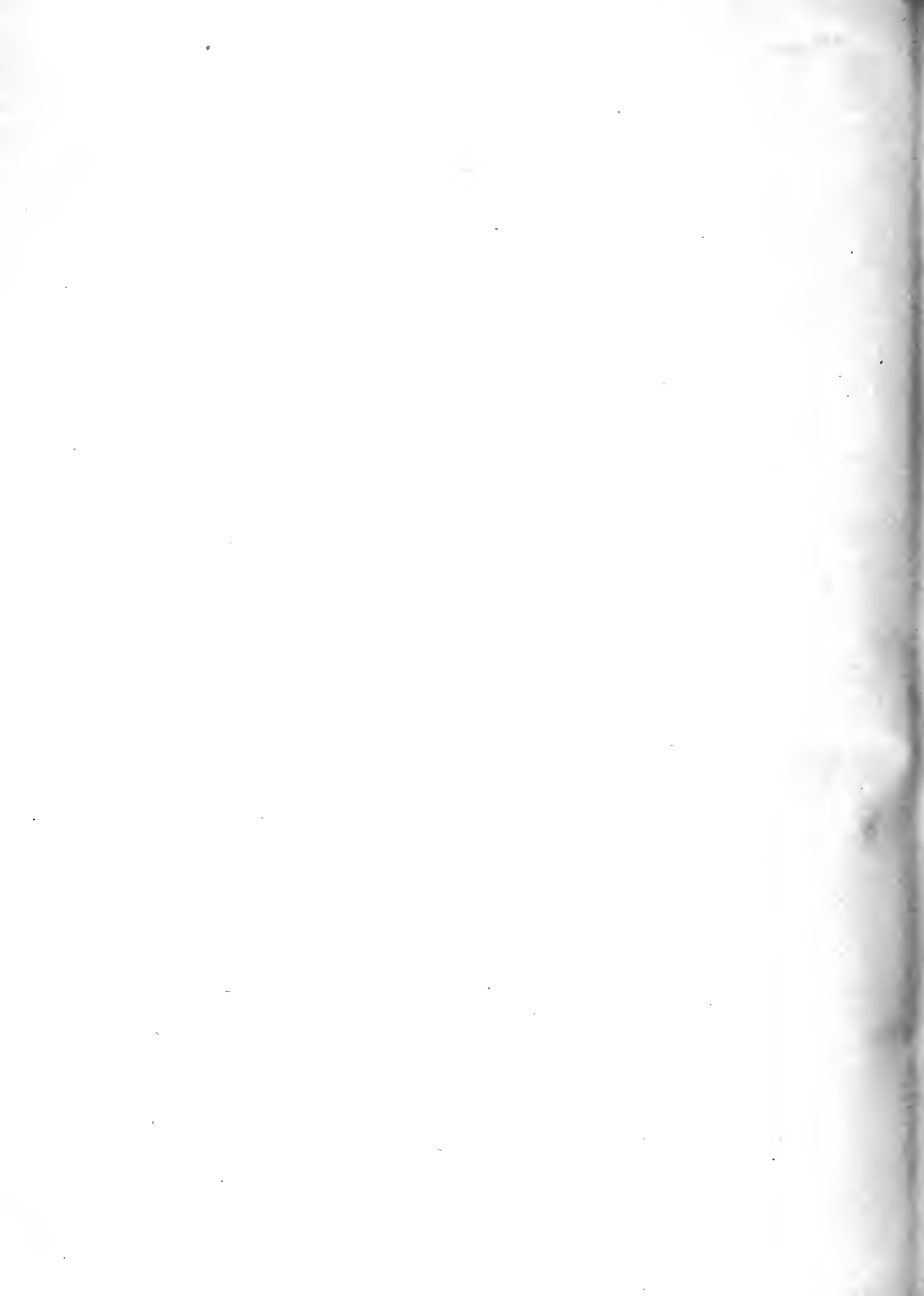

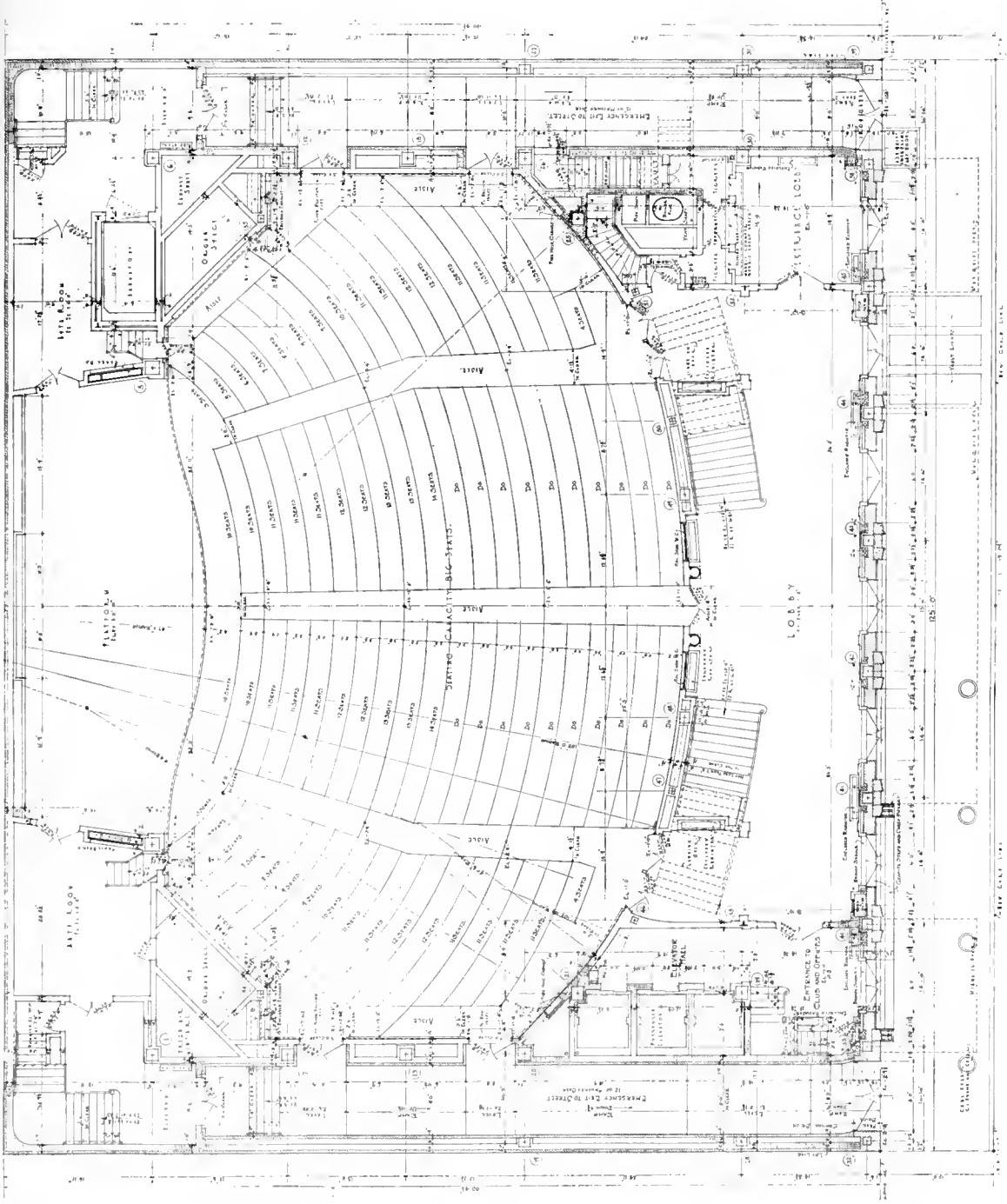

FIRST FLOOR PLAN
THE TOWN HALL, NEW YORK CITY
McKIM, MEAD & WHITE, ARCHITECTS

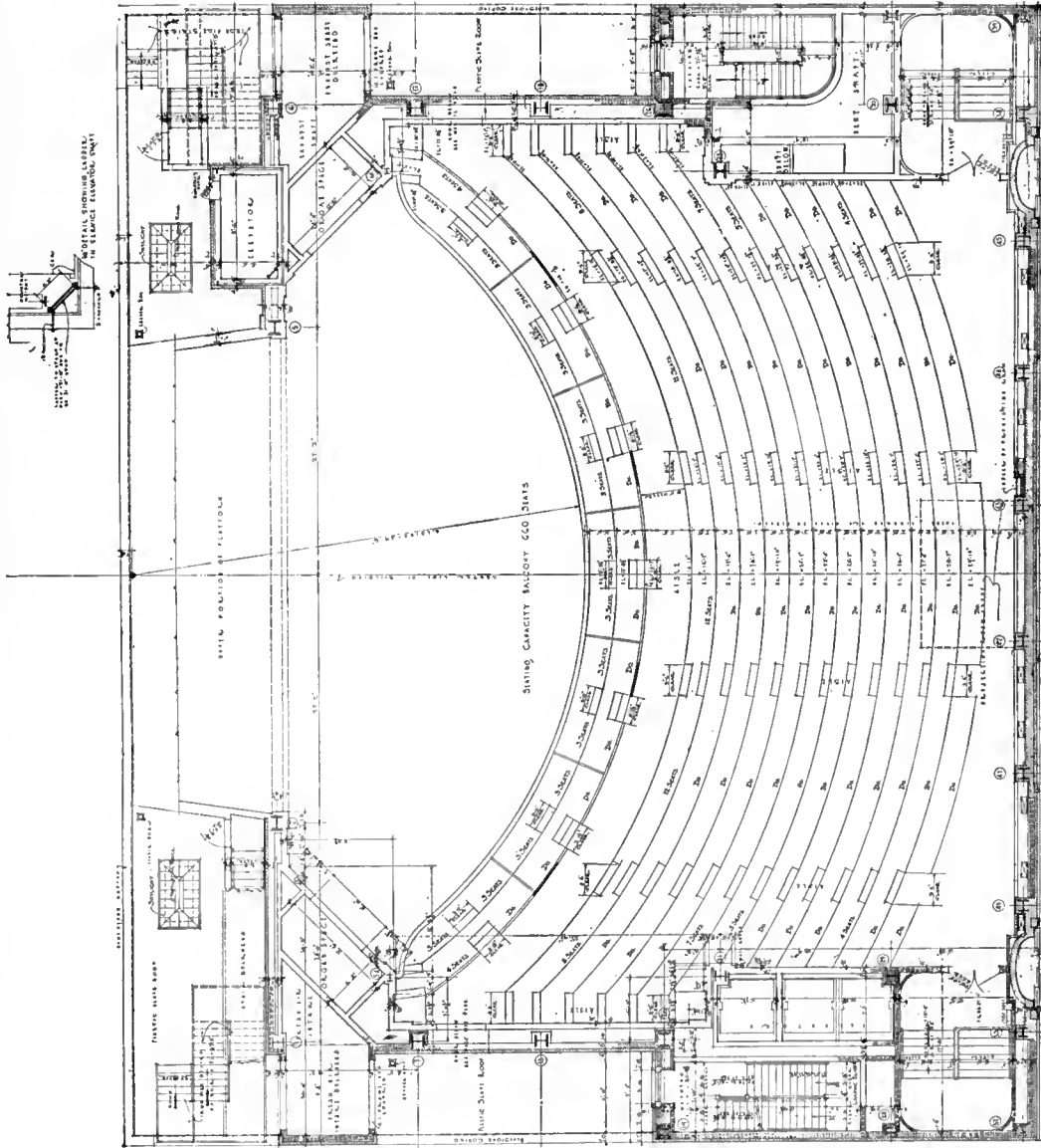

BALCONY PLAN
 THE TOWN HALL, NEW YORK CITY
 McKIM, MEAD & WHITE, ARCHITECTS

150

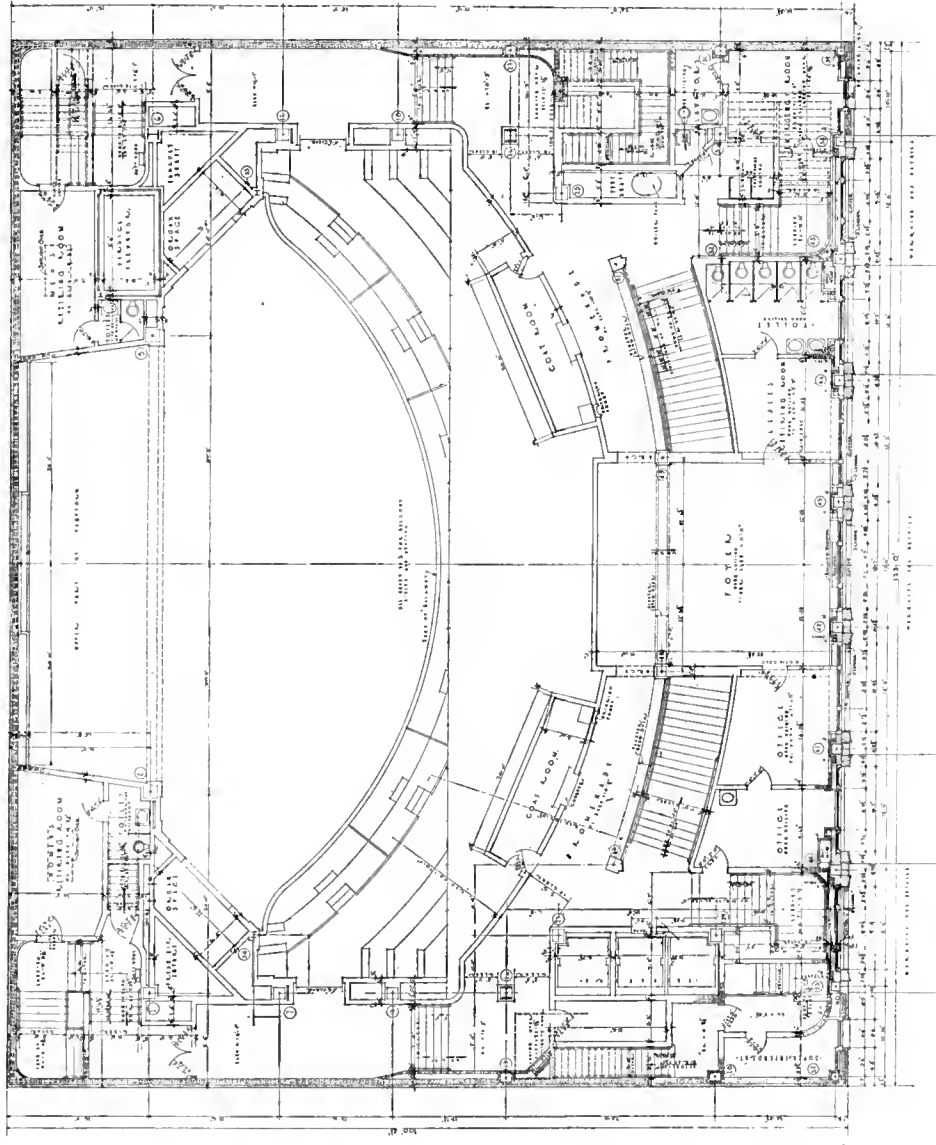

BALCONY MEZZANINE FLOOR PLAN
THE TOWN HALL, NEW YORK CITY
McKIM, MEAD & WHITE, ARCHITECTS

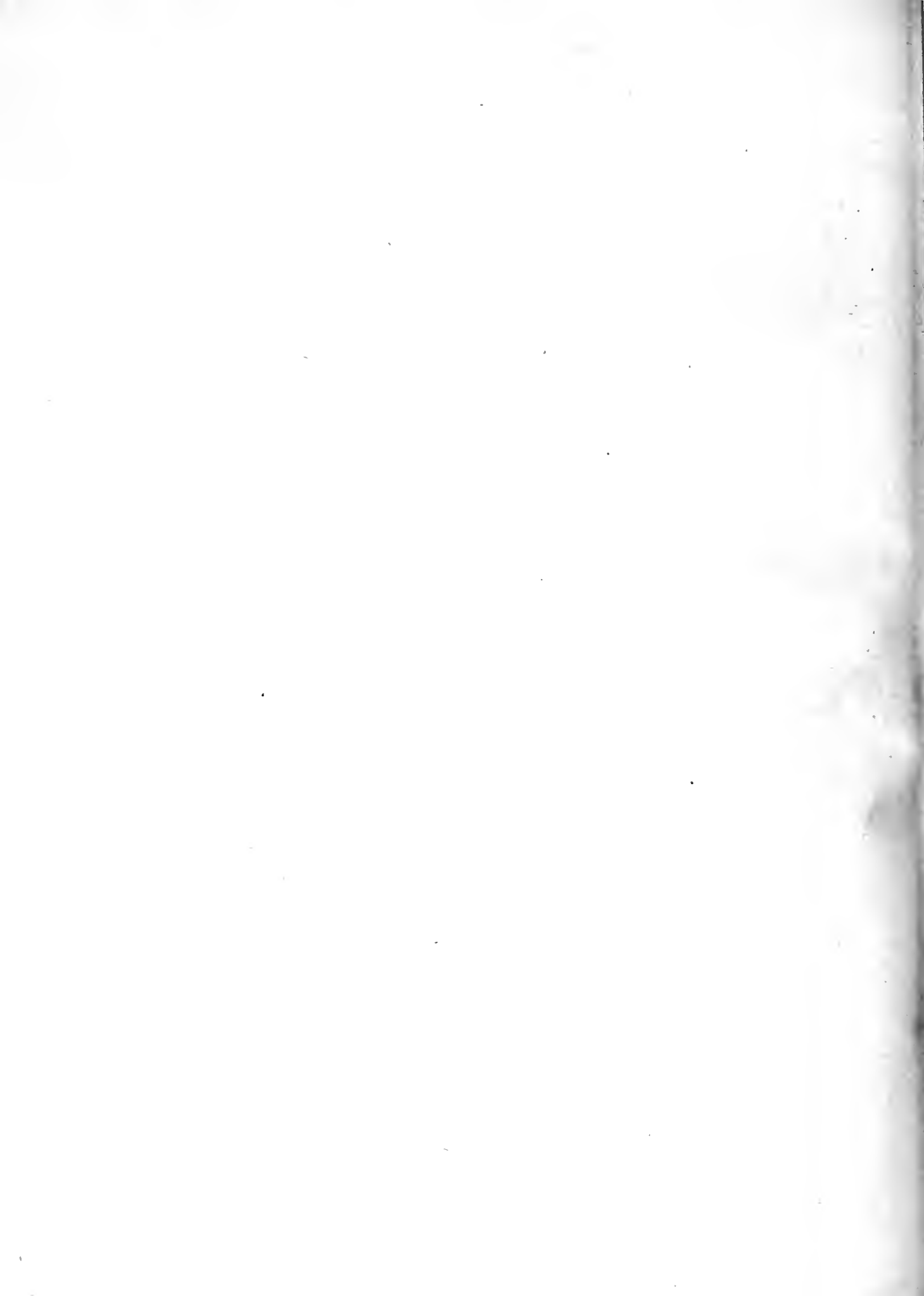

DEPARTMENT OF ARCHITECTURAL ENGINEERING

Good Design Increases Rental Values

Common-Sense Alterations Made an Old Loft Building Into Desirable Space and Brought Increased Rentals

IN all the big cities there are a large number of loft buildings that have gotten into such a state of disrepair that they are undesirable, are hard to fill and bring exceedingly low rentals. Such was the case with No. 45 Maiden Lane, New York City. The photograph shows just how it looked on the outside and is a good indication of the interior appearance as well. Before it was remodeled the outside fire escape shut off light, was unsightly, and it is even doubtful if it could have served the purpose for which it was intended if an emergency should have arisen.

The building was not attractive either outside or inside; it was even repulsive. There was difficulty in finding tenants and the rentals hardly paid for the maintenance and operating expense. These factors prompted the lessee to remodel the building along up-to-date lines.



EXTERIOR OF BUILDING AFTER REMODELING

Note the ventilating louvres at the left

THE AMERICAN ARCHITECT presents here, as an example of the best method of rehabilitating such a building, a description of the thorough alteration made at 45 Maiden Lane through the plans and supervision of the firm of Charles H. Higgins, Architects Engineers, for Adolphe Schwobe, Inc. Importers and Assemblers of Watches.

In discussing the development of this project, Mr. Higgins was emphatic in stating that the principal motive in the design of this plan was "fitness to accomplish the owner's purpose." The arrangement and character of parts, movement of materials and persons, protection from weather and fire, compactness, orderliness, convenience, and proper working conditions for men and women, safety, light, heat, ventilation, sanitation, all make for accomplishment of this purpose. A home for business.



EXTERIOR OF OLD BUILDING AT NO. 45 MAIDEN LANE

As the second photograph indicates, the obscuring and unsightly outside fire escape was removed from the front of the building and was replaced by fire-proof enclosed stairs within. It was then possible to give the front of the building a clean and neat appearance at a fairly nominal expense.

The interior alterations included an attractive entrance hall and mezzanine balcony that increased the floor space in addition to making the appearance more attractive. The walls and floors were refinished throughout the entire building.

From the floor plan it will be seen that the building is a long and narrow one, 17 ft. 3 in. x 124 ft. 3 in., to be exact. The difficulty of properly lighting, heating and ventilating such a building is at once apparent inasmuch as the side walls, 125 feet long, are solid walls and necessarily few windows or other openings. Even where windows were allowable, the light would be cut off by the adjacent buildings.

Part of the problem was solved by the method of indirect light. The fixtures were suspended from the ceiling and the light was reflected upon the white surface and then diffused through considerable area. The white walls and ceilings were necessary adjuncts to this method of lighting the interior. In order to get the proper intensity of light for the requirements on each floor, careful study was necessary to deter-

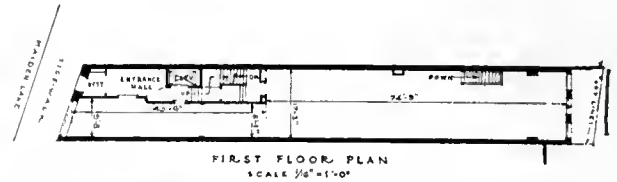

The problem of ventilating and lighting these floors becomes apparent at a glance

mine the size and number of lights, the spacing and the height from the floor. In this the architects were unusually successful. When this form of lighting is properly designed and installed, it is conceded to be more effective and less trying on the eyes than when direct lighting is employed. Such was the case here.

The question of proper ventilation was also solved in an interesting way. Naturally it was expected that the space near the windows on each floor would be partitioned off for private offices. This would leave 75 feet of inner space that would present a ventilating problem just as important as the lighting problem. The doors of the private offices could be



INTERIOR VIEW OF OFFICES

expected to be closed most of the time and there were no windows or openings in the side walls.

The solution lay in running ducts under each floor and through the wall, terminating at the face of the street wall in louvres. At the intake on each floor was placed a heating coil so that warm fresh air from the street could be by-passed under the private offices and drawn into the interior of the building.

In the ceiling and in the corner diagonally opposite the intake there was located a vent to exhaust the stale air. In this way there was always a continuous supply of fresh air at the right temperature in the center of each floor as well as at the ends. The louvres covering the street end of the ducts may be seen in the photograph of the remodeled building at each floor level.

The picture of the top floor is a story in itself.



INTERIOR TOP FLOOR SHOWING EXCELLENT LIGHTING

Note heating coils above



SAW-TOOTH ROOF WHICH REPLACED OLD SKYLIGHTS

This gave a north light over the entire floor

The floor was intended as a watch and jewelry assembling shop and the lighting requirements for watchmakers are of prime importance. This roof was entirely torn down and replaced by a modern saw-tooth roof, giving a north light in the interior. On dark days additional light is obtained by turning on the electric lights which are shown inclined upward. This light is reflected upon the floor by the reverse surface of the saw-tooth.

The walls are white to within 5 feet from the floor. From there down they are green for the comfort of the watchmakers' eyes. Individual drop cords are located at each bench for use on very dark days and when working on exceedingly fine work. The neat arrangement of condulets carrying the wire for these lights avoids the usual tangled and confused appearance of a lot of wires running haphazard in

the air. Each conduit terminates sufficiently high above the bench to allow flexibility in moving the light about by means of the drop cord.

The lighting scheme on this floor in particular has been very successful and shows the results of careful thought and study of the needs of the men. After the remodeling of the building there was little difficulty in securing the best workmen. First-class men are apt to choose their working place with a view to their surroundings and working conditions. The new shop attracts high-grade men and the employer always has his pick of the best. He attributes this to the improved working conditions. A watch-



INTERIOR SECOND FLOOR

Note the effect of indirect light and white walls and ceiling



THE MEZZANINE BALCONY ON THE MAIN FLOOR



THE MAIN ENTRANCE AND ELEVATOR AT THE RIGHT

maker's eyes are his stock in trade. When he injures them, there is not much left for him to do. The workmen realize this and value accordingly good conditions of lighting where they can carry on their trade. This makes selection of the best practicable.

The welfare of the employees is cared for by providing ample locker, toilet and washrooms, sufficient light, heat and ventilation, and safety from fire hazards. The owner felt very strongly that these facilities should be made ample and convenient.

The operation of this building has practically demonstrated the many contemplated economies of operation which were discussed during its planning. Logical, clean-cut and efficient methods of planning have proved their merit. The building is interesting in its fitness for the purpose; effective protection and good conditions for those using it.

There are literally thousands of loft buildings in large cities where the top floor is the least desirable space in the building. In these cases the alteration of the roof along these lines to admit the north light, and plenty of it, would greatly increase the desirability and rental value. These floors would always be in demand for studios, drafting rooms, watchmakers' shops and all classes of trade where light of the right kind and intensity is of great importance.

This job in Maiden Lane was handled by the firm of Charles H. Higgins, architects and engineers, New York City. Every detail shows the careful thought of the trained specialist in making wrong things right, and adapting existing conditions to the special requirements of a particular job. It shows the value of the trained architect and engineer even on a small job like the alteration of a loft building.

Making the Crane Safe*

CRANES of the earlier types were constructed with overhung wheels, i. e., the wheels were entirely outside of the bridge frame, and no part of the bridge extended over the rails. The manufacture of cranes of this type has been discontinued for the most part, but some examples are still met with in practice. This method of construction has been responsible for a number of serious accidents because, if a shaft or axle breaks, the crane may fall to the ground. A break of this kind may be due to a flaw in the metal, or to "fatigue" of the material.

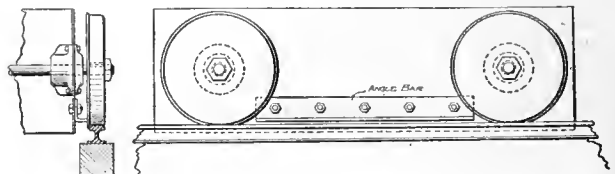

ANGLE BAR PREVENTS FALLING OF CRANE

The sketch shows a method which has proved satisfactory and practicable for providing against similar accidents with cranes of this type. Pieces of 4-in. angle-iron are bolted to the ends of the main frame at a distance of approximately one inch above the rails. These angles project out over the rails so that if the shaft breaks the crane will drop only the distance between the angles and the rails. In at least one known case a bridge wheel came off from a crane on which these braces had been installed, and the angles prevented the crane from falling.

*Extract from the Travelers Standard, January, 1921.

New Basis for Rating and Comparing Warm-Air Furnaces

Discussion of Recent Results in Warm-Air Furnace Research Work at the University of Illinois

By A. C. WILLARD*

ONE of the principal objects of the cooperative research program of the National Warm Air Heating and Ventilating Association has been the development of a method of rating and comparing two or more warm-air furnaces over a wide range of operating conditions. The research staff has given this matter much thought, in the attempt to get a comprehensive method of expressing the capacity, efficiency and other characteristics of a furnace over its complete range of operation. With positive and accurate means of measuring the amount of air handled and determining the correct rise in air temperature, it is now possible to study the performance of a warm-air furnace with definiteness.

Recent tests under the immediate supervision of Professor A. P. Kratz and Mr. V. S. Day of the Engineering Experiment Station of the University of Illinois show that it is entirely feasible to represent this data for any given furnace by a series of simple curves which tell the whole story of furnace operation almost at a glance. With this information before him, the engineer, heating contractor, or architect can not only compare warm-air furnaces of different types and makes, but he can also compare a given warm-air furnace with a steam-heating boiler or a hot-water heater.

INFORMATION NEVER OBTAINED BEFORE

Such information as this has long been desired, but has never before been obtainable. It represents, probably, the most important single result of the Warm-Air Furnace Research Investigation. It means that the warm-air furnace manufacturer will be able to publish as definite engineering data concerning his equipment as any maker of steam or hot-water heating boilers can possibly issue in these closely allied fields. In fact, very few makers of steam and hot-water heating equipment possess such complete data as is represented by these results. As a result of such tests as those shown here, the performance curves of a warm-air furnace can be drawn as definitely as the so-called "characteristic

curves" of an electric motor, steam engine, steam turbine or pump.

Typical results in the shape of performance curves (Fig. 1) are given for one series of recent tests on a pipeless furnace. Since the final data from any portion of this research work is not released by the University of Illinois and the National Warm Air Heating and Ventilating Association until it is published as a Bulletin of the Engineering Experiment Station, the dimensions and description of the furnace have been withheld. Complete data will, however, be reported at the annual meeting of the association. It is sufficient to say the curves are based on actual tests of commercial apparatus, and are used in this discussion to illustrate a new method of testing, rating and comparing warm-air furnaces for the benefit and information of the furnace industry as a whole.

FACTORS DETERMINED BY TEST

The tests on which these curves are based were all run on the same pipeless furnace to determine the following factors, all of which are essential to the proper design and installation of a furnace (pipeless or piped).

(a) Rate of combustion (pounds of coal burned per sq. ft. of grate per hour).

(b) Efficiency of the furnace (ratio of heat put into air passing furnace to total heat value of coal burned, usually expressed as a percentage).

(c) Capacity of furnace in B.t.u. per hour. (British thermal units), which is the heat put into air passing furnace.

(d) Equivalent register temperature of air leaving register based upon a 65°F. inlet temperature. To get actual rise in temperature it is only necessary to subtract 65 from these temperature values.

(e) The draft at the smoke outlet of the furnace in inches of water, which indicates the great importance of providing a satisfactory chimney if the full capacity of the furnace is to be realized. It also shows that *capacity is entirely dependent on draft for a given furnace and a given coal.*

*Professor Heating and Ventilation and Head of Department of Mechanical Engineering, University of Illinois.

THE AMERICAN ARCHITECT

In addition to the above factors, much additional data, such as CO₂ content and flue gas temperature, was determined, but as it is not introduced into this discussion it has been omitted from this list of factors.

An inspection of Fig. 1 will show that the performance of the furnace tested is completely shown for all combustion rates between 4.5 lb. and 10 lb. per sq. ft. of grate per hr. The combustion rates are indicated along the horizontal line at the bottom of the figure. Five tests were run at five different

by reading to the right or left as indicated by the arrows, the following rating and performance data is obtained.

1. Efficiency = 64 per cent.
 2. Heating capacity = 120,000 B.t.u. per hr.
 3. Equivalent outlet register temperature = 202°F.
 4. Draft in inches of water = 0.085.
 5. Rate of combustion = 5.6 lb. per sq. ft. of grate per hr.
- The heating capacity just found (120,000 B.t.u.

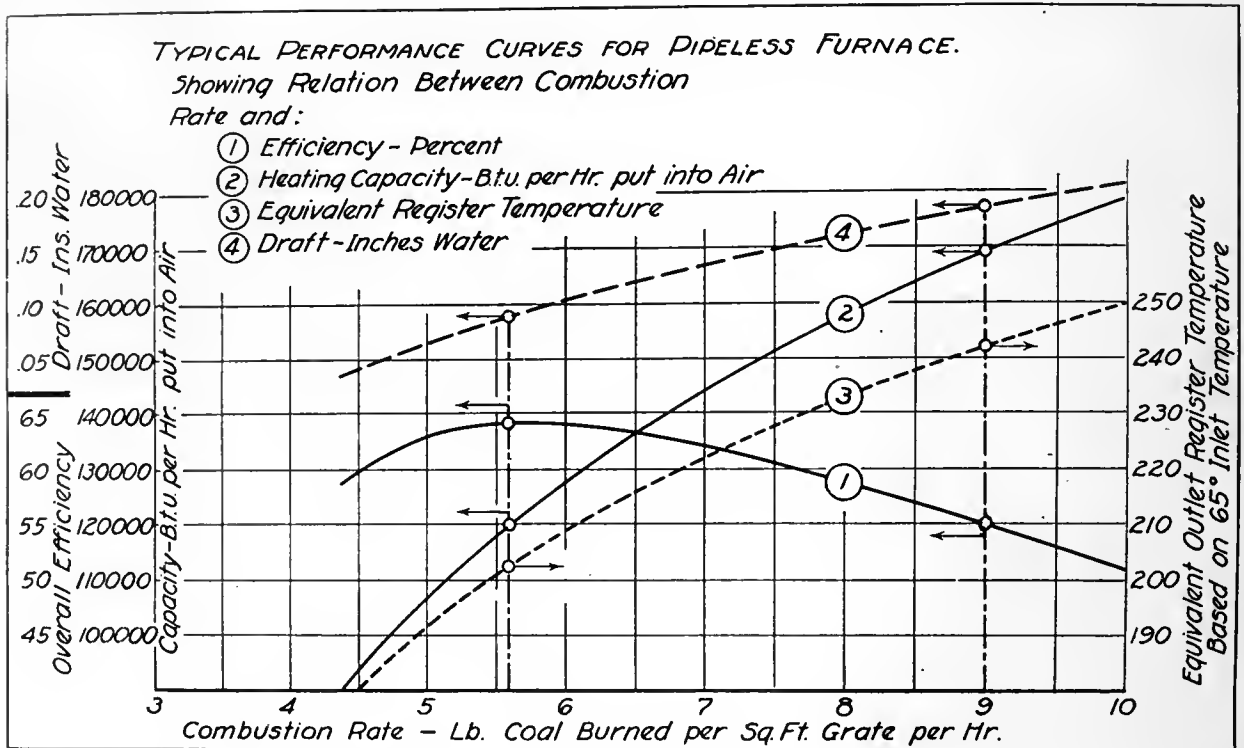

rates of combustion and the results from each test plotted against the corresponding combustion rate at the bottom of the chart. It was then found possible to draw smooth curves through these points and these curves have been numbered and labeled as:

1. Efficiency in per cent.
2. Heating capacity in B.t.u. per hr.
3. Equivalent outlet register temperature based on a 65° inlet temperature.
4. Draft in inches of water at smoke outlet.

After the curves are drawn, it is a simple matter to ascertain under what conditions this furnace will develop its maximum efficiency. To do this, draw a vertical line (shown dot and dash in figure) through the highest point of the efficiency curve (1). This line will cut all the other curves, as well as the combustion rate axis at the bottom, and

per hr.) is not the maximum capacity of this furnace by any means, but it is the capacity at maximum efficiency. The heating capacity of this same furnace can be increased nearly 50 per cent. if the chimney draft can be approximately doubled. By increasing the draft to 0.18 inches it is possible to burn coal at the rate of 9 lb. per sq. ft. of grate and the rating and performance data becomes (see vertical dot and dash line at 9 lb.)!

1. Efficiency = 55 per cent.
2. Heating capacity = 169,000 B.t.u. per hr.
3. Equivalent outlet register temperature = 242°F.
4. Draft in inches of water = 0.18.
5. Rate of combustion = 9 lb. per sq. ft. of grate per hr.

The significance of this method of showing rating and performance data is of the greatest value in

determining upon the selection of the proper furnace or in comparing two furnaces or a furnace and a boiler. Assume the heat loss from a certain house is 170,000 B.t.u. in the very coldest weather which lasts for only a few hours, and that the heat loss under average cold weather conditions which last for many hours is only about two-thirds of this or 113,000 B.t.u. It will be at once apparent that this furnace will handle the average cold weather load at very nearly its highest efficiency, which the efficiency curve showed to be 64 per cent. at about this same rating. This same furnace as shown by the rating and performance curves has a heating capacity of 169,000 B.t.u. when burning coal at a combustion rate of 9 lb. per sq. ft. of grate with a draft of 0.18 inches of water. It would also, therefore, readily handle the severest heating load during the winter, provided the chimney in this house could develop a draft of 0.18 inches of water.

This furnace would, of course, be operating in the latter case at an efficiency of only 55 per cent. with an outlet register temperature of 242° F. as shown by the curves at 9 pounds combustion rate. This reduced efficiency and high register temperature is not a serious matter, however, as the very severe conditions referred to only last a few hours.

VOLUME OF HOT AIR INCREASED

It should be noted that in the example just discussed not only has the register temperature increased from 202° to 242° F., but the weight and volume of air passing the furnace has also increased greatly. The curves can readily be made to show the amount of air handled, as well as the temperature of the air leaving outlet register.

If it is desired to compare this furnace with a steam heating boiler operating at the same combustion rate, it is only necessary to fix the combustion rate in order to make the comparison. Suppose boiler and furnace are to burn the same kind of coal at a nine pound rate of combustion and that the draft is satisfactory. Refer to the rating curves and take nine pounds on the horizontal axis as the index point. The heating capacity as already found is 169,000 B.t.u. per hr. which is equal to $169,000 \div 250 = 680$ sq. ft. of steam radiation. (Each sq. ft. of standard steam radiation transmits 250 B.t.u. per hr.) Now a steam boiler large enough to supply 680 sq. ft. of radiation would need to have a rating of 25 per cent. more than this to allow for mains and branches, or 850 sq. ft. The pipeless furnace requires no allowances for piping connections and the capacity curve shows practically its true heating capacity over its entire range of operation.

Recent Developments in Spray Painting*

THE test samples of spray versus brush painting, conducted at the U. S. Naval Hospital in September, 1919, and described in the pamphlet entitled "A Study of the Practicability of Spray Painting," were inspected during December, 1920, after exposure for about fifteen months.

The exterior brick walls of the building had been painted with a light buff paint, one-half of the area being brush-coated and the other half spray-coated. The wearing properties of the paint applied by the two methods seem to be almost the same, both coatings being in fair condition. Medium chalking had developed and some unevenness of the yellow tint was shown in the form of light colored spots. The latter defect, however, is often characteristic of paints tinted with ochre. Close inspection of the two surfaces with a high-power magnifying glass indicated a rather characteristic spatter effect where the paint was applied by the spray gun, and ridgy brush lines where the paint was applied by brush.

Inspection of the large roof area painted with red oxide paint showed that the brush-coated and spray-coated paints were giving equal satisfaction from the standpoint of durability. Where the paint had been applied with spray guns by workmen not acquainted with the method of application excess quantities, which were piled up in some instances, had run together with the formation of a somewhat wrinkled film in spots. Such films, remaining rather soft, necessarily took up dust from the atmosphere and became slightly darker than the areas coated with thinner films.

Due to the fact that the spraying machine, especially in the hands of inexperienced operators, is apt to apply a larger quantity of paint over a given area than the hand-brush method the heavier films would, of course, show slower drying properties. With certain paints, therefore, which are ordinarily made with raw linseed oil and a minimum of drier and thinner, slow drying properties might be observed. In such instances the use of a substantial percentage of a rapid drying reducing oil of the varnish type would overcome this difficulty. A small percentage of a heavy bodied blown oil to cause "flowing out" and thus obliterate spray-pit marks might also be advocated. Manufacturers of special spray paints might take these points into consideration.

*Extract from a paper presented by Henry A. Gardner before the Pennsylvania State Association of Master Painters, Reading, Pa., January, 1921.

Proper Size and Design for Flues

Space Requirements of Flues and Breechings. Obstructions Often Limit Good Design.

THE proper size for breeching and flue connections is not always given sufficient attention in the layout of a building, and the result is that frequently the contractor installing the flues finds it necessary to resort to all sorts of ingenious schemes to get his equipment in, and in many cases he has to make his flue smaller than good practice demands. This is not a matter of guess or convenience or anything of the sort. If the flue is too small it offers too much resistance to the gases which it is supposed to carry away. The result is that the gases "back up" into the furnace and an actual pressure is built up when there should be a vacuum. A pressure in the furnace forces the intense heat into every crack, and the result is that it does not take long to destroy the brickwork, boiler and furnace equipment and there is a high maintenance cost.

WHAT IS GOOD PRACTICE

It is good engineering practice to design flues so that there will be 35 square feet in the cross section for every rated boiler horsepower. It is important to note that the sectional area of the flue is based upon the builder's rating of the boiler and not upon the actual horsepower developed. For example, a 500-horsepower boiler should have at least 17.5 square feet in the cross-sectional area of its flue connection. If there are four such boilers, the area in the main breeching should be 70 square feet, while each individual connection would still contain 17.5 square feet.

These boilers may actually be designed to develop 200 per cent. or 300 per cent. of their rated capacity. In that case, to increase the flue area is going to help reduce the resistance and will tend to get the gases away faster. In such cases it is desirable to increase this area if space permits. In no case should the area be less than stated above, even though it is known that the boilers will be operated considerably under rating. If the architect bases his calculations accordingly, he is on the safe side.

SHAPES OF FLUES

A circular flue is the ideal flue because it presents the least surface area to the gases. Due to cost of construction and difficulty in making connections and alterations, however, the circular flue is not much used. Of all other shapes, the square flue approaches nearest to the circular flue in the matter of offering the least resistance to the flow of the

gases. It is not always possible to use a square section, but the nearer the rectangle approaches to the square the more ideal it is.

In cases where more than one flue connects into the main breeching, it is good practice gradually to increase the area of the breeching in the manner shown in Fig. 1. The height h_1 is twice h and h_2 is three times h . If there are only three boilers the height remains constant from A to the stack. The width of the breeching should remain the same.

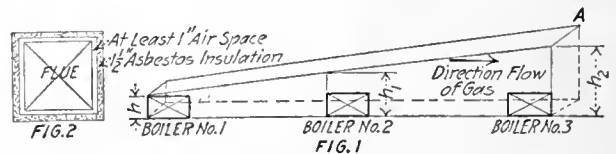

PROPORTIONS AND ALLOWANCE FOR FLUES

Another important matter is that in proceeding from the boiler to the stack no point of the breeching or flues should be at a lower elevation than any preceding point. There should be no downward flow of the gas. Sometimes it is difficult to get around obstructions in existing buildings without doing so. In new buildings this point should be borne in mind, as well as the fact that obstructions should not be so placed that it will be necessary to construct the flue area in one point or to flatten the flue in any marked degree or to change the sectional shape merely for the sake of getting around these obstacles. All these things only add to the resistance and either make necessary higher stack and induced draft equipment or result in furnace pressures.

ALLOWANCE SHOULD BE MADE FOR INSULATION

In figuring allowances for flues in cramped quarters it must be remembered that the flues themselves must be insulated after erection. It is customary to leave an air space of at least one inch between the steel of the flue and the insulating material. This is generally done by wrapping the flue with chicken wire or some such material to hold the asbestos and separating the wire from the flue by inserting distance pieces. The asbestos is then applied to an additional thickness of $1\frac{1}{2}$ to 2 inches, depending upon the conditions. To the width of flue, therefore, there should be added 5 to 6 inches to determine the overall clearance width of the flue. The same applies to the depth.

Current News

Happenings and Comments in the Field of Architecture and the Allied Arts

High Bridge Has Been Saved

Through the untiring efforts of Mr. Arnold Brunner, representing the New York Chapter of the American Institute of Architects, and Col. Wm. J. Wilgus, representing New York engineers, High Bridge is not to be destroyed. As the result of their extended addresses before the Board of Estimate and Apportionment, it has been finally decided to preserve this structure and the alterations proposed will not mar its beauty. For the first time in that body, a vote of thanks was extended to the speakers for their work toward this end.

American Academy in Rome

The annual Fellowship in architecture, of the value of \$1,000 a year for three years, is to be awarded by the American Academy in Rome, subject to the usual conditions. All persons desiring to compete for a Fellowship must fill in an application to be obtained from the secretary, Roscoe Guernsey, 101 Park avenue, New York. This application must be filed, with letters of reference and other information, not later than March 1.

The competition is open to unmarried men, citizens of the United States, who comply with the Regulations of the Academy. These and all necessary details may be learned from the secretary.

Chicago Architectural Exhibit

Announcement is made that the Thirty-fourth Annual Chicago Architectural Exhibition will be held at the Art Institute of Chicago, March 8th to April 5th. This year the exhibition is held in conjunction with the Applied Arts and National Farm and Garden Associations. It is given jointly, as previously, by the Chicago Architectural Club, the Illinois Society of Architects, the Illinois Chapter of the American Institute and the Art Institute of Chicago. The chairman of the exhibition committee is John A. Holabird, while Paul S. Esser is secretary and Hubert Burnham, treasurer.

New York Society of Architects

This Society held its usual monthly meeting at the United Engineering Societies Building, West 39th Street, on Tuesday, the 18th inst. There was a large attendance of members present, together with

a number of visiting architects and engineers, attracted by an interesting and important lecture on "Recent Developments in Concrete," by Lt. Col. Boyden. The lecturer brought out instructive and startling facts as to the hitherto neglected importance of the proper proportion of water in mixing concrete. Thousands of experiments prove the fact that a small quantity of water in excess of the proper proportion will reduce the strength of concrete almost fifty per cent.

A discussion was had on the proposal before the Board of Standards and Appeals to amend the plumbing rules so as to permit the use of "standard" cast iron pipes, instead of extra heavy pipes. Unanimous disapproval was voiced by the meeting against the proposed change in the plumbing rules, and a resolution was passed to that effect.

Two new members were elected and two proposed for membership.

Announcement from N. C. A. R. Boards

Architects interested in reciprocal transfer can obtain information with reference thereto by addressing the National Council of Architectural Registration Boards, 3230 West Monroe Street, Chicago.

Nebraska Chapter Elects Officers

H. W. Meginnis, of Lincoln, was elected president of the Nebraska Chapter of the American Institute of Architects at the third annual meeting of that body in the University Club.

C. W. Steinbaugh, of Omaha, was elected vice-president, and J. D. Sandham, also of Omaha, was re-elected secretary and treasurer. G. B. Prinz was elected a new member of the executive committee.

Alan McDonald, retiring president, was toastmaster at the dinner at the University Club. Guests of honor were: Governor McKelvie, William L. Steel, of Sioux City; George W. Bates, Lincoln, city engineer; Charles Battelle, Omaha; V. Ray Gould, Omaha, contractor; Charles F. Harrison, Clark E. Mickey and Dr. J. E. Summers, all of Omaha.

The new registration law, now before the State Senate, which provides for the establishment of two boards of examiners, one for engineers and one for

THE AMERICAN ARCHITECT

architects, was a main topic of discussion at the afternoon session. Architects generally favor the bill.

An exhibition of four typical small house plans was also a feature of the meeting. The exhibition was made with the idea of formulating a method which will permit good-looking houses to be built more economically.

Roosevelt Memorial to Surpass All Others

To erect the finest memorial erected in America is the aim of the Roosevelt Memorial Association. The Roosevelt memorial will be erected in Washington. Its form is being debated.

But as a work of art and architecture it is intended to make it surpass even the Washington monument and the Lincoln memorial, recent reports announce.

International Congress of Cities in Paris

Paris has been chosen, at a recent meeting of the Union Internationale des Villes, as the next meeting place, in 1922, of the International Congress of Cities. The last congress was held at Ghent in 1913, and proved very stimulating to municipal, official and civic reform organizations the world over. A special effort will be made to secure attendance of representatives from all national associations for civic betterment.

World's Fair in Philadelphia

A committee of 100 has been named to have charge of arrangements for and financing of the proposed exposition to be held in Philadelphia in 1926, to celebrate the one hundred and fiftieth anniversary of the signing of the Declaration of Independence.

Mayor Moore was named active chairman and John Wanamaker, who served on the centennial committee of 1876, honorary chairman. Alba B. Johnson, president of the Chamber of Commerce, is vice-chairman.

An inspiring and comprehensive plan by Dr. Paul P. Cret for the arrangement of a site has been submitted to about 400 representative citizens and received with enthusiasm.

The plan was presented and explained at the forty-ninth annual meeting of the Fairmount Park Art Association by Andrew Wright Crawford, secretary of the art jury.

Dr. Cret, noted French architect, who is professor of design in the school of architecture of the University of Pennsylvania and who has been prominently identified with city improvement activities

several years, proposes that the Parkway and both the east and west banks of the Schuylkill be utilized as grounds for the international exhibition.

Mr. Crawford, who outlined the plan in an address on "World's Fairs and Their City Planning Salvage," said Dr. Cret's suggestion to use the Schuylkill embankments, beautified and connected by ornamental bridges, was "astonishing because it could be carried out so easily."

Details of the project will appear in a future issue of THE AMERICAN ARCHITECT as they are developed.

Co-operative Housing and Garden City League Formed

Under the name of the Co-operative Housing and Garden City League of America, a new society has been formed, with the landscape architect Robert Anderson Pope as chairman, to promote co-operative housing and to create for this purpose a loan fund to be applied to the investigation of the advisability of acquiring basic sources of essential building materials, their means of production and distribution, and if more capital becomes available, to the construction of model housing estates.

Jersey City Planning

Jersey City has completed within the last few weeks an organization to plan for the future development of the city. The mayor has appointed a commission of five to which the Chamber of Commerce has added four of its members. They will co-operate with a number of city officials appointed for this purpose on a joint City Development Plan Commission. The program embraces development of through streets and highways, civic centers, parks, playgrounds, tunnel routes, a housing system and a high speed motor vehicle belt road. The City Commission, by resolution, endorsed the plan and appropriated the money needed for investigations and other preparatory work by the city engineers.

Jersey City Building Active

Houses for two hundred families will be built by a corporation authorized a few weeks ago by the Jersey City Chamber of Commerce and financed by business men of that city. The new houses will be of the so-called Philadelphia plan of five-room double-houses, with two families to each side. It is expected that costs will be reduced 25 per cent by the simultaneous construction of fifty such two-family houses. Each two-family house when completed will be sold separately at about \$10,000, with a first payment of \$2,500 and monthly installments of \$98, including taxes, water rent and insurance.

THE AMERICAN ARCHITECT

The first mortgage of \$7,000 will be placed by the corporation. As the estimated shortage of homes in Jersey City is over 1,400, this project is not expected to discourage private construction.

Inter-State Bridge

One of the greatest projects of its kind in New England, according to the *Portland Express*, is about to be started. This is the magnificent Maine and New Hampshire Memorial bridge to be erected over the Piscataqua river between Portsmouth, N. H., and Kittery, Me. Estimated to cost over two million dollars, it will completely outshadow the famous local Portland Bridge, which reached the million mark but which could not be duplicated today for a very much larger sum.

While the cost of the new structure is to be divided equally among the two States and the Federal Government, the major portion of the benefit to be derived from it is to be received by Maine. The great local advantage, however, is to go to Portsmouth. The bridge is to form a remarkable gateway into the Pine Tree State, through which will pour at least 75 per cent. of the automobile tourist traffic.

The great local benefit received by Portsmouth will be the fact that it will form a free means of access for the towns of Maine, in its vicinity, into the New Hampshire metropolis to trade.

Balsa Wood Lighter Than Cork, Durable as Cedar

Balsa wood, growing notably in Costa Rica and Ecuador, is the lightest wood known, weighing only 7.3 pounds to the cubic foot. Cork weighs 13.7 pounds. Growing more rapidly than almost any other known tree, it is said that within four years a balsa tree will attain the height of 30 feet, with a diameter of ten inches. It is as durable as cedar.

The wood is white, extremely straight grained and easy to work. It is soft when green, but seems to harden later. It is used extensively for making life rafts and life preservers, and it is thought that it will eventually constitute a valuable source of pulp wood. A brown-colored cotton-wool, commonly used for stuffing pillows and mattresses, is also produced.

It is believed that the tree would flourish in Florida and because of its rapid growth would spread easily over the southern part of the state.

Billboard Nuisance in Massachusetts

At a cost of millions, says the *Boston Globe*, Massachusetts, has built a system of magnificent park boulevards and highways from the Atlantic Coast to the Mohawk Trail. "No sooner do these roads bring

the splendors of our landscape within reach of the eye (and we are no worse sinners in this respect than our sister states) than we allow them to be defiled at every turn by glaring atrocities which urge us to invest in this brand of tooth paste and that brand of chewing gum." The Women's Municipal League of the City of New York, which quotes this and other evidence of the continued existence of the billboard evil, is endeavoring to check the abuse.

Niagara Power

From Niagara River only 26 per cent of the total flow is diverted for generating electricity, and engineers say that 60 per cent could be diverted without marring the scenic beauty of the falls, hence it is asserted that "millions of horsepower are going to waste." A treaty with Great Britain limits the amount of power that can be developed at present.

Puppets in Egyptian Tomb Show Ancient Conditions

Innumerable puppets, representing the household retainers of Mehenkwtre, a great Egyptian dignitary of 2000 B. C., taken from a concealed chamber of his tomb and illustrating in detail the life of the people of that time, have just been put on exhibition at the Metropolitan Museum of Art. They were excavated by the Museum's Egyptian expedition at Thebes and are considered one of the most important of recent discoveries.

The puppets, who are shown performing different household arts and duties in the fields and on the water, are funerary models and form the most complete set ever excavated.

Mehenkwtre was a chancellor and steward of the royal palace in the reign of King Mentuhotep III., and his tomb was located in the choicest spot in the necropolis of his day, overlooking the mortuary temple of the sovereign.

The tomb had been plundered several hundred years after the interment of the dignitary whose body it contained, but neither those early nor later visitors discovered the hidden chamber which the museum excavators found intact. To facilitate the carrying on in another world of the pleasures which the great man had enjoyed on earth practically every occupation which ministered to his comfort had been reproduced with these miniature servitors, that he might enjoy them in the new life he was entering.

The puppets seem to be inhabitants of a doll world, but they actually reproduce the life of the early Egyptians and, from the fullness of the details, they throw light upon many interesting points not previously understood.

Circulating of Pictures

Circulation of pictures, on a plan similar to that followed in the circulation of books by public libraries, has for some time been carried on to a small extent in Boston, New York, and possibly other cities. The Brooklyn Y. W. C. A. has recently started such a circulating library for reproductions of the best pictures, which are lent for two weeks or a month. Each picture is accompanied by a brief account of the artist's life, data about the school and period of art and the significance of the particular work. The next step, apparently not contemplated in this case, but adopted elsewhere, is that of enabling borrowers to buy at a modest price pictures which especially appeal to them.

U. S. Is Wearing Away

An average of 95 tons of soil, pebbles, and loose rock is carried by the rivers into the ocean every year from every square mile of the United States, according to the United States Geological Survey, Department of the Interior. The immensity of this contribution may be better comprehended when it is realized that the surface of the United States covers 3,088,500 square miles.

Old Paris City Walls to Be Used for War Area Homes

The inner walls of Paris, relics of the city's defenses in the old baronial days, are going to make buildings in war devastated areas of France. Where they stood, Paris will have its first model playground, in the Pagnolet quarter, laid out on American lines by the Junior Red Cross. Announcement by the Red Cross said twenty miles of good building stone had been saved from leveling the old fifty-foot defenses bordering the Paris moat.

Conspicuous Automatic Doorsill Permits Exit Only

To enforce the one-way traffic rule through the establishment, the management of a large garage has installed an automatic doorsill across the exit. The device is made of heavy steel and is hinged and counterweighted in such a way that, normally, the edge toward the street is held several inches above the drive level. This presents an obstruction which cannot fail to challenge the attention of an approaching driver. To a car advancing from the street side, the obstruction is very real. Immediately the wheels of an outgoing car bear upon the sill, the apparently formidable bump becomes a smooth, level path, the heavy threshold sinking into a recess in the driveway. A conspicuous decorative scheme and the

admonitions to use the entrance and also to cross the sill in low gear have the desired effects of preventing movement against the direction of traffic and of making cars leave the building at a safe rate of speed.

Borglum to Carve Army on Mountain

Gutzon Borglum has taken up again his plans for carving a vast memorial to the Confederacy on the face of Stone Mountain, a great granite monolith just outside Atlanta, according to a recent announcement.

Nothing so stupendous as the Stone Mountain undertaking has ever been planned in art. Stone Mountain is a solid block of granite, the northern side of which is a sheer cliff nearly 1,000 feet high and 1,500 feet wide. That perpendicular surface, it was explained, is without seams and even enough to offer a vast natural canvas for the sculptor's chisel.

The memorial will take the form of a big army, composed of more than one thousand figures of southern leaders, marching across the face of this cliff. Mr. Borglum, it was stated, will cut the figures in heroic proportions, forty or fifty feet in height, so that they can be recognized for four or five miles. The principal figures will stand out in complete relief, while other figures will be scaled down through various stages of relief to mere chisel sketches on the surface of the stone, thus giving the appearance of an army fading into the heart of the mountain.

Mr. Borglum plans to retain a large number of artists under his supervision. The artists will work upon the face of the cliff from steel cages swung on cables down the side of the mountain.

Mr. Borglum estimates that it will take about eight years to finish the work, at a cost of several million dollars.

Personal

Mr. Gerald Joseph O'Reilly, Room 11, Hippodrome Bldg., Miami Florida, is desirous of receiving manufacturers catalogs, specifications and price lists to complete his files.

Damon, O'Meara & Hills, Architects are now operating offices in Suite 1123-1124 Merchants National Bank Building, Saint Paul, Minn., and at 19 East Mason Building, Fort Dodge, Iowa. The Saint Paul office would like to receive literature.

T. Beverly Keim, Jr., architect, has moved from room 202 to room 716 Haas Bldg., Los Angeles, Cal.

A. E. Sedgwick and N. W. Alpaugh, architects, have moved their offices to Suite 506, Garland Bldg., Los Angeles, Cal.

Weekly Review of the Construction Field

With Reports of Special Correspondents in Regional Centers

A STUDY OF PRICES*

By

EDMUND D. FISHER
(Vice President, Bank of Detroit)

PART III

[Refer to page 107, issue of January 26.]

An old English document states that in 1314 "Complaints to the King that the market of Oxford ran unreasonably high, so that poor scholars could hardly live, so the King sent down his Mandate to regulate this affair." An attempt was then made to establish the following price schedule, which is interesting in view of present costs:

	l.	s.	d.
A stalled, or corn-fed ox.....	01	04	00
A grass-fed ox.....	00	16	00
A fat stalled cow.....	00	12	00
An ordinary cow.....	00	10	00
A fat mutton, unshorn.....	00	01	08
A fat mutton, shorn.....	00	01	02
A fat hog, of two years old.....	00	03	04
A fat goose, in the city, 3d, but every- where else.....	00	00	02½
A fat capon, in the city, 2½d, elsewhere.....	00	00	02
A fat hen, in the city, 1½d, elsewhere.....	00	00	01
2 chickens, in the city, 1½d, elsewhere.....	00	00	01
4 pigeons (in the city but 3 pigeons).....	00	00	01
24 eggs.....	00	00	01

This comment is made in the article in question: "Things could not be purchased at these rates, for people would not bring them to the market (and that is a thing that Parliaments cannot remedy), and so the King was fain to revoke the former act, and leave the people to sell as they could (for a trade will do as it can, and never be forced, one way or the other)."

READJUSTMENT should contemplate a reasonable profit, and prices should bear a proper relation within the season to the preceding season's or preceding year's price schedules. An economic commission might very happily analyze the entire subject, and, for what it is worth, publish what would seem to be a proportionate basis of prices from year to year within the economic period involved. In correlation with this, the government should develop a comprehensive plan of taxation fairly distributed and provide for a stated reduction of the national debt over a sufficiently long period of years. This would at least serve as a guide to the business world, and tend to prevent the business difficulties which are sometimes developed by the discussion or operation of unsound legislation.

*Copyrighted, 1920, by Edm.und D. Fisher.

It is comforting to realize that a period of deflation, based upon average experience, is a period of growing wealth. Take a characteristic period of deflation in England experienced from 1874 to 1896 (a gold movement). During this period the average of wholesale commodity prices fell 40 per cent. It was a period of increase in production the world over, and of growing wealth, in which England, of course, shared. It was a period of gradual increase in wages, although the greatest benefit to the wage earner came from the reduction in prices. An English economist states: "Looking at this period as a whole, there seems to be no evidence that employment was any less regular than in preceding periods."

A composite judgment based upon the thought of authoritative writers and speakers on the subject of "What is necessary to bring about the orderly decline in prices," may be stated as follows:

1. That bank credit for legitimate business be not unduly restricted.
2. That the public writings and speeches of influential men be directed toward the upbuilding of business morale by spreading the gospel of confidence in our own economic strength, which must be supported, however, by normal production.
3. That the maintenance of a fair volume of export trade will tend to stabilize prices, and through the helpfulness it will give to the upbuilding of stricken nations, will react favorably on the United States.
4. That as much stress as possible be laid on the argument that a small profit on a normal production is better than a large profit on a curtailed output.
5. That manufacturers and merchants in a strong financial position should place reasonable orders to encourage trade during depressed periods.
6. That a consistent advertising policy is necessary to stimulate the buying public.
7. That at the present time a revision of our tax laws is necessary to normalize business and investment relations.

After all, and in conclusion, an orderly decline in prices is largely dependent upon the attitude of the credit men and the credit grantors of the country. An analysis of credit statements during the period of deflation will undoubtedly many times show a status of depreciated inventories and limited liquid assets. Forced liquidation, however, would tend to a disorderly decline and abnormally low prices. While a consistent reduction in prices is desirable, it is quite undesirable to have a greater reduction than is logical for a proper relation to the basic economic conditions. For stability, we must have full employment, continuity of spend-

THE AMERICAN ARCHITECT

ing power, and reasonable prices. The credit man, therefore, must, when possible, permit the element of time and the principle of helpfulness to cure some of the business difficulties brought to his attention.

A knowledge of the principles of prices is most important in credit granting, as the movements of prices, as has been pointed out, directly affect credit conditions. The inventory is usually the most important factor in the commercial statement, and a radical change in value may mean much added wealth or ultimate insolvency. A most important factor to remember in a period of deflation is that while the value of the inventory may shrink and the surplus be reduced, the cause which brings this about—the decline in prices—is also increasing the value of each individual dollar. What is apparently a reduced surplus may and probably will indicate a greater wealth than the swollen surplus that previously floated on the froth of the tossing waves of inflation.

(THE END)

(Any architect desiring this address in full, printed attractively in booklet form, may obtain it by writing the editor of this journal.)
Next Week: "The Architect's Relation to Price Declines"

(Special Correspondence to THE AMERICAN ARCHITECT)

SEATTLE.—There was some slight unsettlement of the steel market during the week on the impression of jobbers that the steel corporation prices, especially in sheets, may show further declines. What these reductions will be if any will depend on how badly the outside mills need tonnage. This situation is just the reverse of what it was during the last two quarters of 1920. It would appear from the way jobbers feel that the independent mills are masters of the situation.

Jobbers report ample warehouse stocks of roofing, sheets, cement, plaster and plaster wall board. The situation seems to radiate around March, which it is thought will more clearly disclose the construction tendency of the Pacific Coast territory than any other month. There is a growing belief among both the metal and lumber interests that construction will start around the first week in March. It is thought that by that time builders will have concluded that materials are at their bedrock levels and that to wait longer would be to endanger the possibilities of prompt delivery.

It is the feeling of jobbers that basic costs must be hurried forward if the building year is to be propitious and business is to settle to the point where building-up can begin. Jobbers in pipe, sheet metal, plumbing supplies and metal furnishings insist that as fast as their costs are dropped they pass the advantage on to the trade, but that the trade is not responding in kind. Unless some speed

is shown in giving investors this advantage as it occurs it is predicted that retailers will suffer in finance. Small losses can be taken now more readily than large ones in March or April, and few communications pass that do not contain some reminder to retailers to speed up recessions in order that building projects may be pushed beyond the pencil sketch stage.

Doyle & Merriam, architects and engineers of Seattle, have opened bids for demolishing the Boston block, four stories in height, to make space for the new exclusive banking quarters of the Seattle National Bank. Work is to begin March 1. This is the first of three exclusive banking structures to be erected in the permanent financial district on Second avenue south of Spring street within the next two years. The Union National will involve an outlay of \$1,000,000.

Approximately 46 per cent. of the fir lumber mills in what is known as the West Coast Forest products territory have resumed operations since the holidays. Log and labor overhead have decreased 15 to 25 per cent., and logging contractors seem to have run afoul of each other as to what constitutes the actual market. The result is beneficial to the mills that have no timber of their own but must buy on the open log market from time to time according to their needs.

Eastern building is quiet, according to lumber orders received from east of the Missouri river. Retail yards, who represent the wishes of builders in their respective communities are inclined to believe there will be further price recession. This position may be well taken, but the mills expect a rush of orders with early spring and buyers will be taking their own chances in delay. It is not believed that prices could fall any appreciable extent, as the mills will not sell on the market as it stands today.

(Special Correspondence to THE AMERICAN ARCHITECT)

CHICAGO.—Chicago's building boom which loomed so brightly on the immediate horizon a few weeks ago is beginning to assume some of the characteristics of a desert mirage and is growing less tangible as it is more closely approached. With mild February weather giving hint of early spring conditions, when building might be starting somewhat ahead of the usual frost-out-of-the-ground period, there is a tendency on the part of those connected with the building industry to complain at the apparent lack of building activity.

Architects say that there is comparatively little work on the boards just now, although there is considerable inquiry and a great deal of tentative figuring. Contractors report the same state of

THE AMERICAN ARCHITECT

public mind and even the lumber and materials men indicate that spring business has thus far failed to transcend the inquiry stage.

The reason back of it all is manifold, but mainly it is due to the state of uncertainty and expectancy which a falling market has built up in the public mind. With the daily newspapers giving prominence to every downward slant, a mass psychology has been created, which expects a much deeper plunge of the toboggan back toward economic readjustment. This watchful waiting is manifested by the disposition on the part of those whose minds are made up to building activity, to wait and see just what the situation will really come to in the end.

Another complex in the situation is the failure of finance to come to the rescue except at high rates and unusual commissions.

Just what the outcome of all this is to be is a problem that is puzzling a great many people in the Chicago building industries, architects, contractors, materials and lumber manufacturers and all the rest.

Optimistic leaders believe that the situation can very well turn from bearish to bullish in the span of a week or so and that hectic activity can very easily relieve the present dullness almost overnight. The fact that the building shortage is so acute and the pay-me spirit of the average flat-owning landlord so apparent is looked upon as a goad that cannot fail to encourage building, particularly in residential and apartment buildings, once the complicated conditions now prevalent are even slightly cleared up.

Once building is fairly started it is felt by many that there will be a rush that will be reminiscent of boom days of the past. It is the initial impetus, however, that is now lacking.

As far as Chicago is concerned there are signs here and there that the tie-up is beginning to crumble.

One of the signs of better times ahead is a recent building permit for a million dollar apartment building. This is to be a nine-story structure to be erected in the Rogers Park district by G. M. Posner, of G. M. Posner & Co., builders. Work is to be started on the building at once.

There were twelve other permits for apartment buildings in the January list, a significant fact inasmuch as apartment buildings have been conspicuously absent from the building permit lists during recent months.

Although apartment permits show an increase for January, the general building situation is not improved, according to the building permit report. At a date well toward the close of January only

60 permits had been issued as compared with 171 in December of 1920 and 328 as compared with January of last year.

The growing number of apartment permits is viewed with satisfaction by Charles E. Bostrom, building commissioner, who in his recent annual report pointed out that Chicago needs from 75,000 to 90,000 more apartments.

In his report were figures covering building in Chicago for a period of seven years, which is interesting enough, perhaps, to be reproduced. The report follows:

Year	Building Permits.	Valuation
1913	10,792	\$89,668,427
1914	9,938	83,261,710
1915	10,340	97,291,150
1916	10,277	112,835,150
1917	4,938	64,244,150
1918	2,529	34,792,200
1919	6,589	104,198,850
1920	3,745	79,102,650

Lack of money for building is getting more and more to be the focus of the building apathy in Chicago and public attention is being more centrally directed to the solution of this stringency. The past week has seen some three or four possible plans for the relief of the condition.

One interesting plan has been evolved by the Corn Exchange National Bank, which hopes to encourage definite savings toward home building. Briefly, the bank's plan is this:

The man who desires to own a home contracts with himself to deposit with the bank a certain sum each month toward a first payment. At the very beginning of the savings and throughout the period of home-owning thrift, the bank supplies advice and information on building, plans, real estate and other things that the prospective home-owner ought to know. By the time the depositor is ready to buy or build he is well posted on the details of the transaction.

What is of more interest than the plan itself, is the fact that three thousand inquiries and three hundred new accounts were developed by the plan within a week.

The Building Trades Council which is made up of thirty-eight unions in the building industry is fostering a plan to raise a bond fund of \$5,000,000 to spur building. This fund is being predicated upon a bond issue on an important business skyscraper which has lately been taken over by an important co-operative investment society. Funds from this plan are not yet available, but hope is held out that something may be forthcoming from this source.

Still another plan which is not lacking for proponents is a scheme to secure special legislation

THE AMERICAN ARCHITECT

which will permit the state to issue building bonds at a low interest rate, untaxable and to be sold without commission as a means of financing home building and home owning.

Out of all this planning, something is expected to evolve and those in closest touch with the building situation are hopeful that advancing weeks may change the whole face of the situation which admittedly does not seem as bright now as it did two or three months ago.

The demand for lumber and building materials continues to be without spirit or feature and prices which have prevailed for some time are continuing unchanged, because the price really plays very little part in the lumber and materials business just now.

The prices are about as follows:

Yellow Pine: B. & B. 1-in., \$95 to \$130, depending on thickness; 2 x 4, No. 1, 10 to 16 ft. length, \$51 to \$53; 2 x 6, \$48; 2 x 8, \$50; 2 x 10, \$53; 2 x 12, \$55; 13-16 x 3¼ z & b flat flooring, \$85 to \$90; 1 x 6, No. 2 common, \$48 to \$90. *Douglas Fir*: 2 4 S, in sizes up to 12 x 12, in length up to 32 ft., \$65 to \$70; 14 x 14, \$68 to \$73; 16 x 16, \$72 to \$75; 18 x 18, \$75 to \$80. *Hard Maple*: Four, ¼ No. 1 and 2, \$135; select, \$120; No. 1 common, \$100; No. 2 common, \$65; No. 3 common, \$32. *Birch*: Four ¼ No. 1 and 2, \$160; select, \$133 to \$138; No. 1 common, \$95 to \$100; No. 2 common, \$60 to \$65; No. 3 common, \$40. *Red Gum*: Four ¼ No. 1 and 2, \$150; No. 1 common, \$90 to \$92; No. 2 common, \$45.

Face Brick—Standard, vitrified red, \$32@34.00; Smooth, Indiana red, \$38.00@40; Smooth Ohio red, \$38.00@40.00; Smooth, Pennsylvania red, \$46.00@48.00; Smooth, buff, \$45.00@47.00; Smooth, gray, \$47@49.00; Rough, buff, \$44.00@46.00; Rough, gray, \$47.00@49.00; Variegated, rough texture, \$34.00@49.00.

Common brick, \$16.00 per M. Portland cement, \$3.00 per bbl. Torpedo—Lake and bank sand, \$3.50 per yd. Crushed stone, gravel screenings, \$3.50 per yd. Hydrated lime, Ohio, paper, \$22.00 per ton. Hydrated lime, Ohio, cloth, \$29.00 per ton. (Includes sacks at 30c. each.) Hydrated lime, Wis. paper, \$20.00 per ton. Bulk lime, \$1.75 per ton.

(Special Correspondence to THE AMERICAN ARCHITECT)

BOSTON—The outstanding feature here this week was the opening of all the textile mills, large and small, in New England. After several months during which mills were either completely closed or running but one or two days a week, at the present time all are open, with some operating on a full time basis and others on four or five days a week schedule, with indications that full time may soon be resumed.

This is important to architects in that the industrial situation as a whole in New England (and therefore any component part of that situation) depends almost wholly on the textile business. Once the general industrial situation is cleared up, there will be a marked improvement in the building industry. A most significant fact is that, almost without exception, the mills are renewing with wage cuts of 22½ per cent. in effect, the American Woolen Company being the last large concern to announce the reduction. In practically every case, the workers returned to their looms without marked protest. This is most certainly an encouraging factor.

Leading textile mill owners are on record as declaring that more goods have been sold in the last three or four weeks than during the entire six months preceding. There is every confidence that the revival is not a flurry, but a healthy renewal of life in the textile industry.

More than 80 per cent. of the workers are back in Fall River and from 70 to 80 per cent. are again at work in other important textile centers in this section, including the more important centers of New Hampshire and Rhode Island, also in Maine. About 50 per cent. are reported as working in Lowell, Lawrence and New Bedford.

Andrew Adie, president of the United States Worsted Company, declares the industry is now on the "front edge" of a healthy revival.

All reports agree that there is little merchandise in the mills' warehouses and that practically all new business must be met by a resumption of mill operations.

Architects here find these symptoms most encouraging. The uncertainty of the textile situation has been a decided drawback to any comprehensive or even partial building program. Owners were not willing to put money into any new project where the inhabitants of the communities were either out of work or in a state of uncertainty concerning their next day's meals. The importance of the textile industry here is comparable somewhat to New York's commerce. Imagine New York's harbor bottled up for weeks and you have a fair idea of what the situation has been here for some time.

Your correspondent finds that a number of architects are looking forward to such a distinctly bettered industrial situation that a number of building projects will now very probably go forward without further delay. Architects generally in the New England region are looking forward to a distinct improvement in the building industry, as a result of the improved textile situation. It is even possible that the workers in the building industry may agree to certain wage cuts in order to speed the revival of building, precisely as the textile operators have accepted their wage cuts in the same spirit.

frontis piece to 2756

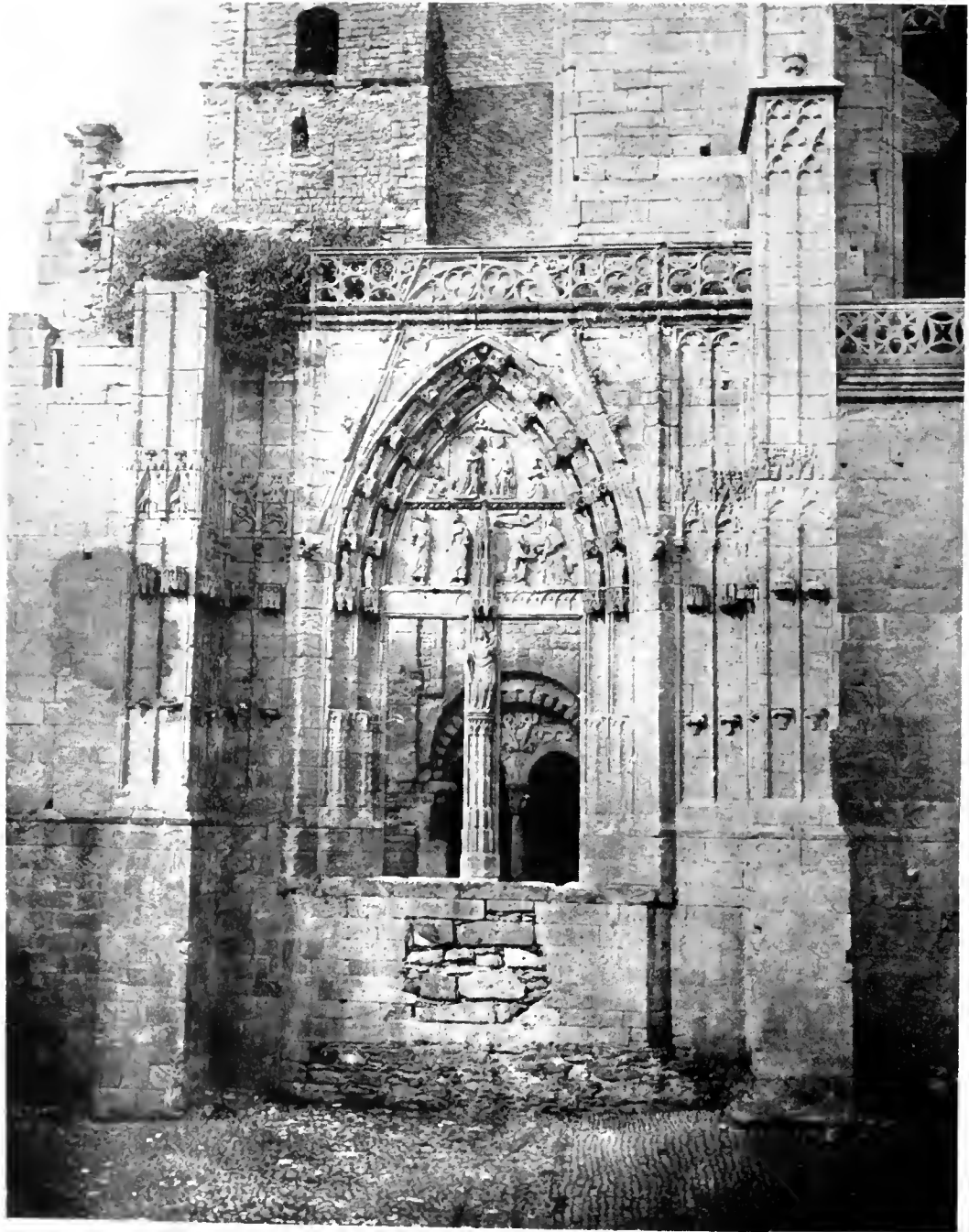

GOTHIC WINDOW—THE CATHEDRAL, WETZLER, GERMANY

THE AMERICAN ARCHITECT

VOL. CXIX

WEDNESDAY, FEBRUARY 16, 1921

NUMBER 2356



BAR-LE-DUC

Reconstruction in Northern France—V The Future

By RALPH FANNING

STANDING in the doorway of a tiny wooden barrack, talking with the owner of this poor though much appreciated substitute for his once pretentious dwelling and gazing out across the broad fields still bearing the marks of a cruel devastation, as one listens to one's garrulous host telling of the beauty of the various spots, of the adjacent village and neighboring fields "avant la guerre," one tries to visualize the future of the massacred regions of Northern France. Having traversed the devastated regions of the old battle lines, and having been deeply impressed or perhaps depressed by the breadth and magnitude of material destruction, the like of which had probably never been witnessed before the Great War, and with the compelling force of vivid

contrasts, having recalled the peace and prosperity of these regions in their pre-war days, one wonders what the future will bring forth. Even with the plucky attempts made by the returning refugees to begin life over under the most trying of living conditions, what will Time, galloping over the next ten or twenty years, do for the stricken areas of Northern France? In what form and in what style will be the buildings that are to take the place of the 600,000 destroyed homes? What shape and plan will be that of the new villages that supplant the picturesque old ones as the waste areas again come under the constructive rule of Peace?

Prophets are not without honor except when making their forecasts on the devastated fields them-

THE AMERICAN ARCHITECT

selves where, surrounded by all the chaotic destruction, it is often difficult for the most optimistic to predict any very rapid reclamation. Especially is the prophet apt to command no great credit among those who have not learned to appreciate the many sterling qualities of the French peasant makeup. There has been much criticism of the way that the French have undertaken their gigantic tasks of reconstruction with unfavorable comparisons with the work in Belgium. It cannot be denied by anyone who has had to unsnarl a way through the entangled meshes of French official red tape, and has seen the suffering and discouragement that delay and apparently useless politics inflicted, that there have not been times when one was apt to say most uncom-

rapid depreciation in the value of her currency. She expected the Germans to supply the necessary labor. The days of the Pharaohs are past and slave labor has long since been proved to be non-productive. To date the Germans have done practically nothing although it must be stated in justice to the groups of German prisoners allowed for the building work in the Meuse, that more capable, willing and industrious workers would have been hard to obtain, once

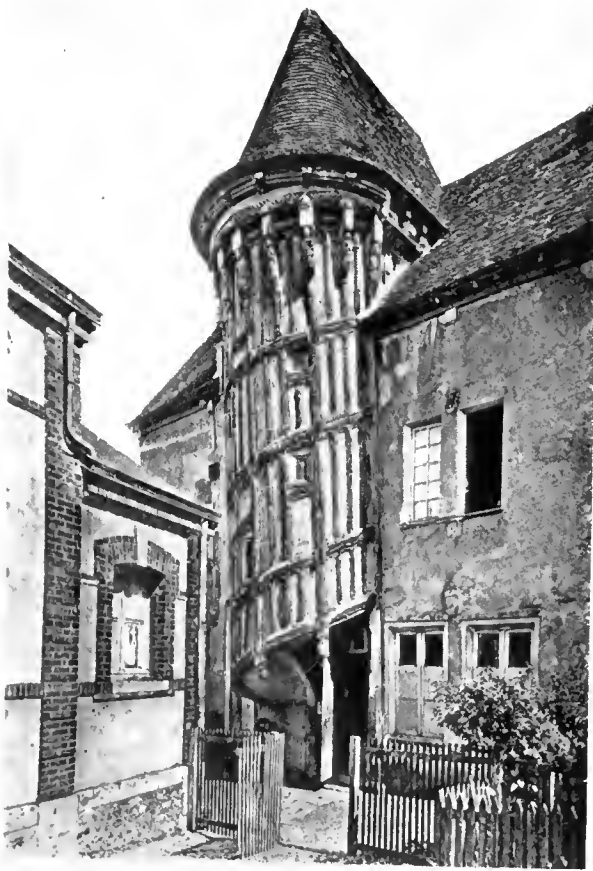

CHARTRES—STAIRWAY OF QUEEN BERTHA

plimentary things about Gaelic business methods and political systems.

When immediately after the armistice, the government refused British and American aid for permanent reconstruction, France hoped to promote her home industries, although it seems that she could not have realized her exhausted state nor foreseen the



BOURGES—BIRTHPLACE OF JACQUES-COEUR

sustaining rations and some degree of humanity were granted them. It now seems that if there is to be any very rapid reconstruction, it must come through foreign assistance. Nor is this any disparagement to the French people at large when one considers what the nation has been through during these years of struggle. One must needs turn from censure to admiration when thoroughly considering what they have withstood and of what they have given many proofs of being able to accomplish. No country involved in the war, not even Belgium, had to withstand the magnitude of suffering that was inflicted upon France. Many a French village of the devastated regions had hardly a male citizen of military

THE AMERICAN ARCHITECT

age returning to take up the fight of peace times. Consider the miles of occupied and contested territory through the valleys of the Somme and Oise, the Aisne and the Marne. Think of the railroads alone of which eight hundred miles were still to be reconstructed on the first of last May. Without means of transportation, any reconstruction work could progress but slowly. Not dwelling further upon the vastness of the problem, one may look for hope for the future and find it in the toiling figures of the fields, that, reminiscent of Millet's paintings,

the future may be gleaned by a visit to the drafting rooms of the department of "Regions Libérées" at Bar le Duc, Châlons or other "prefectures" where draftsmen are busy on village plans and property lines. More hope for the three dimensional progress may be obtained by a visit to bustling Rheims or to secluded Grand Prè, to cite two specific instances of very different places where the work of permanent reconstruction has already begun. Rheims before the war had a population of more than 125,000 souls, living in some 17,000 houses. By the latter part of the summer of 1918, the city was supposedly evacuated of all civilian population and, of the homes, but few were undamaged beyond much hope of repair. By the beginning of 1920, little more than a year after the cessation of hostilities, twenty-five thousand people were reported back within the mutilated city and organized rebuilding was well under way. While retaining the essential project of



VITRY-LE FRANCOIS—THE BARRACKS

are everywhere seen trying to gather something from the thorny aftermath of war. Forgetting the unpleasant experiences with cumbersome officialdom and profiteering "entrepreneurs," one may take hope in the remembrance of the acquaintance with cultured and refined old men and women, accustomed to pre-war culture, wealth and leisure, coming back to their old homes with only their pluck and gentility left, there to undertake with their own hands the sordid tasks of cleaning and repairing their demolished homes.

From an architectural viewpoint, some hope for



HOUSE IN CHARTRES—XV. CENTURY

the old city plan with its admirable squares, plans are being executed to unite the railroad stations for more efficient communication than the old plan afforded; to improve the location of the market-



BAR-LE-DUC—THE CLOCK TOWER

places; to open up the vistas toward the cathedral whose towering grandeur, shut off since mediaeval days by the encroaching buildings, was, in a way, more thoroughly appreciated after the leveling of the entourage. The city will for generations to come retain the ugly scars of battle, but a few years are pretty certain to see Rheims intact and prospering. With its crowds of tourists on their pilgrimage to the heroic cathedral and its location in the midst of rich though sadly uprooted vineyards, it is bound to recuperate, although its buildings must necessarily show the effects of inartistic haste and dearth of the substantial building materials of old, while the quaint old historic houses can never be reproduced.

Compared with such a famed and easily accessible town as Rheims, the fate of the smaller secluded village is not likely to be as happy. Yet, Grand Prè in the Ardennes may be cited as an example of one from many of the more remote villages that are taking on new life. Here a new village has been laid out with straight streets and open places to substitute for the compact dwellings that bordered the curved streets of the old town. A model school-

house with ample play-ground to take the place of the former cramped école, and fresh air and cleanliness are items to be considered as never before, thanks to the new institutions of district nursing and public welfare. These are but two very different examples cited from the many places where the work of rebuilding is progressing.

The story may be heard if one talks with some old patriarch about the Marne Town of Vitry-le-Francois of how the place won its name in the XVIIth century, as well as how it was saved from destruction by the integrity and diplomacy of the mayor and curé when they were taken as hostages by the late enemy. Whether the story of the name be authentic or not, it is illustrative of the typical home devotion of the inhabitants of Northern, and perhaps as justly stated, all of France. It seems that Francis I, "Père des Lettres," who has come down in history as a most energetic and progressive builder, had pet schemes of town planning that would rival in beauty and order many of our gardenesque plans of today. By his orders and under



THE ARGONNE—CHURCH IN SERVON, 1914

his directions, was laid out the new town of Vitry with model symmetry and harmony to replace the older Vitry that had incurred his majestic dislike.

THE AMERICAN ARCHITECT

In spite of the great public square, covered market and imposing facades offered them by the royal builder of the new Vitry, the people of the older town were loath to forsake their accustomed homes and tried manner of living. So stubborn were they in their resistance that in order to compel them to move, Francis had the homes of the old village burned one by one, thus forcing the villagers to move over to the new. Still they would not be content with the new village in name, but called it Vitry-le-Francois to differentiate it from the old Vitry-le-Brûlé, (Vitry the Burnt). The hundreds of French towns which have been forced to seek new character by even more drastic methods than those employed by the Valois king, have not the newly modeled quarters awaiting their reception, yet it is to be wondered at how great an extent they will be enabled to cling to their old styles and tradition of building.

Architectural design, if it be virile and vital, must ever mirror the conditions of time and place and masters and means that make for its creation. As a natural development, perhaps it is not safe to hope for a much different style of building than is to be seen in the other recent architectural developments in France. Perhaps it is unreasonable to expect other than machine made goods from factory system of production. Greek curves could hardly be the expected output of a concrete mixer, nor is it more logical to expect the subtle curves of village streets, the natural picturesqueness of uneven rows of houses with lines and tones mellowed by centuries, to be obtained by an emergency housing program put through in minimum time under present labor conditions. Even if the old lines were retained, the newer, lighter and more machine-made construction would not have the same charm as the old, but

events has been interrupted by the World War, is there a demand for new and better homes.

The devastated areas of France have the advantage of offering artistic prototypes and charming architectural traditions to the future builder if he is capable of adapting the old style to a logical construction in new material and with modern labor. It is to be hoped that the people themselves will appreciate the wealth of their artistic inheritance and cling to it as their ancestors have clung to their old homes and family traditions. May the examples of the old style, relics of which remain in nearly every community, furnish keynotes for the remodeled scenes which are gradually to take the place of the old. May the new villages grow up in conformation to all the new teachings,—co-operation, sanitation, and advantageous public and private institutions that the years of war occasionally forced upon the people in exile, but as they develop, with all these, may there still be retained that individuality and naivete, characteristic of older days.

With families again united, French homes are sure to revive: with church and school again filled, something of the old order will be continued: with farms and industries re-established, the old trades and manners of work are quite certain to reappear. With the soft limestone and red tiles, sapin lath and rough plaster again on hand, the painstaking French craftsman will no doubt again be able to erect simple homes of beautiful proportions, the gardeners to train their pear trees into many branched candelabrum effects and clip their planes and box into shapely geometrical forms. It is hoped that money will not be sufficient if poverty will tend toward an avoidance of the display of jig-saw skill, fancy dressed stone and distasteful combinations of the materials such as modern French building taste seems apt to favor. If only they can content themselves with relying upon their native charms and simplicity of honest construction, not mimicing the fads of the metropolis, but relying on the merits of their native costumes for the grace that is their birthright, even though trade may inflict a change of materials and hygiene suggest a more ample cut.

Such vast destruction and economic waste as have had the fields of Northern France for their theatre of action cannot be obliterated in one or perhaps many years. Many generations of future inhabitants and travellers in these areas are to be reminded by broken walls and crumbling stone of the years of savage strife. Diligent work on the part of man and friendly aid and co-operation from other nations is the pressing need. Backed by this the unceasing labor from the callous hands of the French peasant is going to be the potency which will re-create their land and make the world richer for "La belle France, encore."



MINAUCOURT AFTER A BOMBARDMENT

would be apt to suggest the artificial and theatrical. So to a degree, the housing problem of Northern France as far as design goes is much the same as the housing problems the world over;—especially in all the countries where the more natural course of

The American Specification Institute

AS heretofore produced specifications have been largely the product of individual effort and as such have varied in many features that can be conventionalized so as to be common to all. Owing to a present lack of means for collecting and distributing information concerning specifications and the writing thereof, there is a needless duplication of study, research and labor on the part of specification writers. Practically all other professions are so organized that the interchange of knowledge is effected with resulting improvement in the quality of production and professional standing. It is to improve the conditions affecting the writing of specifications and to benefit by organized effort that THE AMERICAN SPECIFICATION INSTITUTE is organized. This organization is intended to be national in scope and invites co-operation of all those interested in specifications. The plan and scope of this organization follows:

I. PURPOSE

1. To increase knowledge concerning and improve the methods of writing specifications. The kinds of specifications included are those for buildings, engineering structures and all works whatsoever in which materials of construction and labor are used; for the installation and use of mechanical and sanitary apparatus and equipment; for the fabrication and installation of all furnishings and furniture; for all ornaments and ornamentation, both interior and exterior; for paving, planting, embellishing and improving of grounds and waterways; and for such other things as are produced or sold on specifications.
2. The Institute will not interfere with any of the present organizations such as
 - a—The American Society For Testing Materials
 - b—Kindred national and local architectural and engineering societies
 - c—Manufacturers' and trade associations.but will endeavor to carry forward the activities of such and give additional assistance to specification writers.

II. BENEFITS TO BE OBTAINED

The architectural and engineering professions will gain through

- a—The development of specification writers
- b—The development of specifications that will eliminate cause for argument and

guesswork and lower the cost of building construction by eliminating waste of labor and materials

c—Professional recognition of specification writers

III. MEMBERSHIP

Will be composed of

1. ACTIVE MEMBERS

a—Persons who devote their entire time or a part thereof to the writing of specifications

2. ASSOCIATE MEMBERS

a—Persons who employ specification writers

3. HONORARY MEMBERS

a—Testing and laboratory engineers

b—Instructors in specification writing in architectural and engineering schools

IV. ORGANIZATION

a—Will be governed by a constitution and set of by-laws

b—The secretary will direct the activities of all researches, co-operation with other societies, etc., and will secure and provide answers to all inquiries of the members.

V. ACTIVITIES OF ORGANIZATION

1. Study of materials

a—The production and physical properties of raw materials

b—Methods of manufacturing, fabrication and finishing

c—Relative value based on appearance, initial cost and maintenance, effect of combinations with other materials and proper materials for various types of buildings of varying grades.

2. Methods of writing specifications

A study will be made of:

a—The means of accomplishing complete co-operation between the drawings and specifications and determining

What methods of construction and installation should be used

What the drawings should show or indicate

What should be omitted for inclusion in the specifications

b—The development of an outline or checking list

c—The general contract conditions

d—Specific requirements governed by local conditions

THE AMERICAN ARCHITECT

- e—Use of Standard Specifications of materials as prepared by societies and manufacturers
- f—The arrangement of specifications so as to conform to the sequence of construction and installation of the work
- g—The writing of specifications that are clear, concise, coherent and that can be understood by the courts
- h—The principles of contract law as it affects the writing of specifications
- i—Possible standardization of building codes.

- 3. The securing of the adoption of recommended practices by the professions and others concerned
- 4. The deliberations of the Institute discussions, treatises by members or invited contributors and other matters will be published.

For further information, applications for membership, etc., address Organization Committee, THE AMERICAN SPECIFICATION INSTITUTE, Gardner C. Coughlen, Sec'y Pro Tem, Room 1144, American Bond & Mortgage Building, Chicago, Illinois.



CHURCH OF THE SACRED HEART, NORTHAMPTON, MASS.
JNO. WM. DONOHUE, ARCHITECT

The Billop House, Staten Island

(See Reproduction of Original Drawing by O. R. Eggers on Opposite Page)

THE Billop House here presented by Mr. Eggers is one of the earliest examples of American architecture. From its first beginnings it has been linked with events in American history that have endeared it as the background for many legends.

At a time back in the 1660's the Duke of York claimed Staten Island as part of the colony of New York. New Jersey also wanted possession. In order to give his decision the semblance of fairness the Duke ruled that all islands lying in or near the harbor which could be circumnavigated in twenty-four hours were to belong to New York and the others to New Jersey. In those slow old days this was a tedious process and the Duke was put to it to find a competent sailor. It was Captain Christopher Billop, in command of a small vessel, who succeeded, and this act won from the Duke of York a tract of land containing 1,163 acres.

The house here illustrated, located at Tottenville, is the oldest structure in Staten Island and was built by Billop soon after the land was presented to him in 1668. It stands a little way beyond a group of farmhouses under the shade of huge trees generations old, such as one rarely sees in this part of the world, where axes and forest fires have wrought havoc.

During the Revolution, Generals Howe, Cornwallis, Clinton, Burgoyne and others were entertained there. Under the roof of the Billop House was held the only peace conference of the Revolution, which took place on September 6, 1776. Benjamin Franklin, John Adams and Edward Rutledge had been appointed by the Continental Congress to confer with the English on the issues of the war. The house was used as a barracks during the Revolution and in the cellar there is a brick vault and dungeon, large and finely arched, which is said to have been put to stern use. It is believed that an underground passage was made at that time, leading down to the river, a distance of two hundred yards.

The gloomy tales of the dungeon, the suffering prisoners, the underground passage, are only one side of the old house's history. Gay and sparkling scenes took place above. Many a banquet did the old manor see; many a daintily brocaded lady, many a gallant, ruffled and powdered gentleman. Its rise and fall encompass perhaps every human emotion and it is one of the honored landmarks of a rich country.



U. E. 44 ER.
The Billop House,
Staten Island.

BILLOP HOUSE, STATEN ISLAND, N. Y.
THE AMERICAN ARCHITECT Series of Early American Architecture

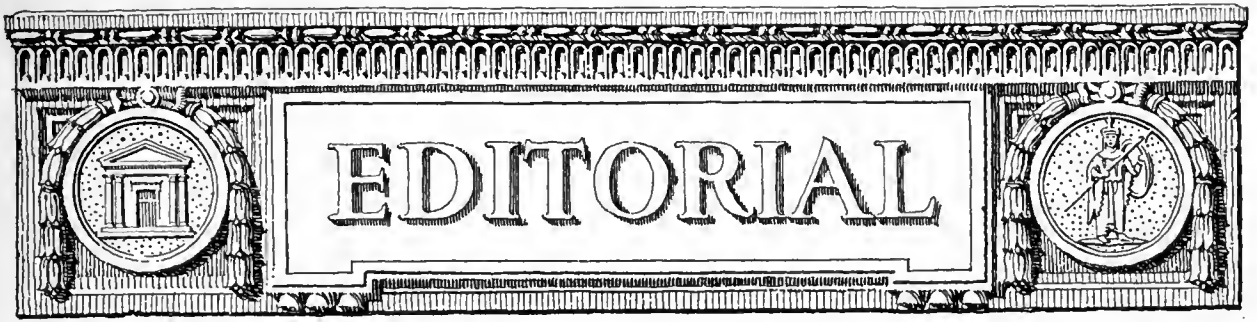

The American Specification Institute

IT is a distinct satisfaction to be able to present on another page of this issue a complete prospectus of the organization now forming to place specification writing on a plane somewhat in keeping with its importance. That comparatively few architectural offices have heretofore given this subject the attention it deserved has been readily apparent from a study of the specifications issued by them. A careful reading of the Specification Institute's prospectus leads to the belief that if the plan set forth is carried out the net result will be not only better buildings for less money, but also a definite enhancement of the architect's reputation.

THE AMERICAN ARCHITECT cheerfully pledges its support to this movement and also bespeaks the active co-operation of the profession with the group of men who have undertaken this work with no thought or possibility of personal gain. In fact it is perfectly apparent that the profession as a whole, rather than any individuals, will profit by the betterment of any of the processes by which architects procure a final result.

Greenwich Village, Los Angeles

A GROUP of men in Los Angeles, it is learned, have bought certain ground in that city where they propose to build an amusement center. There are to be one and two story reinforced concrete and brick amusement buildings, theatre, studios, art building, cafes and residences, and shopping district. This section of Los Angeles is to be called Greenwich Village.

To a New Yorker, to anyone pledged to historical accuracy, this seems a misleading and in a sense desecrating thing to do. The real Greenwich Village stands for certain traditions. One cannot successfully imitate a thing that has grown through long years, whose very history is the reason for its existence.

Yet Los Angeles is satisfied to build a series of more or less standardized reinforced concrete, modern buildings, and by usurping a time-honored name,

let it appear that there is presented an honest replica of the ancient, weather-worn, picturesque structures which have been converted and reconverted to serve purposes dictated by an ever-changing populace.

There is a mental twist, a certain looseness that sanctions a misrepresentation like this. Nomenclature is useless if it is not accurate. The many dwellers on the coast who have never seen the Greenwich Village of Manhattan will be given false impressions as to what it stands for; and indeed today, it is the admixture of foreign folk with the native residents that gives Greenwich Village in New York an atmosphere which not even an honest physical duplication of surroundings can produce outside of the metropolis. Its very cosmopolitan quality is its distinguishing trait. This is felt as one saunters through New York's Greenwich Village. A subtle something that is not apparent to the eye, but that causes it to reveal a different and novel aspect with each variety of type that one happens to encounter. An Italian peasant woman transplanted, it would seem, from the sunny fields of Italy, but really living two streets away. Some little Chinese boys who had strayed from winding Doyers Street with its dilapidated yet tidy houses, and are unconcernedly washing a cat in the public drinking fountain. A short-haired girl in a painter's smock, heavy Indian beads around her neck, gazing abstractedly at a man who carries a brief case and studies the erotic captions of erotic books in an erotic shop window. A limousine which pauses before an Italian restaurant to discharge two fat women in seal coats and a gray-haired man with a silver-topped cane. A feeble, bearded Jew, bent under a huge jute bag of waste paper. All this, in Greenwich Village.

And the quaint old gabled houses, reminiscent of Dutch occupation. The stables of old Washington Square mansions now used for studios. The occasional, amusingly discordant public garage. The crooked streets laid before there was thought of a city plan. The fine doorways of private dwellings where once lived the aristocracy of a peaceful town.

An Indian Village, a large Dutch farm, a small English colony and one of the earliest American settlements—all have left their marks on Greenwich

THE AMERICAN ARCHITECT

Village in New York. Today it is the habitat of the artist, the writer, the dreamer, both the genuine and the poseur. Here come those students in art who hope to develop under the influence of metropolitan, or cosmopolitan life, the faddist and the would-be great, as well as the tried and proven artists. It is of happiness to those who cannot afford the luxury the home of happy, care-free indigence and ambition. It gives music and conversation and touches of more formal places. It gives color to many a life that would otherwise be drab.

Picture it in brand-new modern white reinforced concrete buildings, regularly laid out in cold uniformity in Los Angeles!

The Personal Equation

AN EDITORIAL BY SULLIVAN W. JONES, A.I.A.

WHAT is the matter with the individual? AT a time when we should hear the thunderous voice of the multitude demanding to know the facts—there is silence. At a time when every person should be giving his thought to the problems of reconstruction, we find instead the expression of the vast public to be indefinite, waiting for someone else to do its thinking for it. Instead of a lively interest which would seem to arise inevitably from the individual's need, we have the unlovely spectacle of legislative committees investigating conditions while the Press and the Public satisfy their appetite for sensation and scandal.

While this is the general situation there are small groups—pathetically small—of forward looking citizens, committees for research and study and a few scattered individuals with views and understanding, occasionally suggesting constructive programs, which, however, fall upon deaf ears and closed minds.

On the other hand, there is no lack of complaint and condemnation. The average individual seems to have lost his sense of responsibility for things as they are and has joined the herd in its quest for victims upon which to vent its wrath.

Individually and collectively, by both omission and commission, we are responsible for things as they are. Particularly is this true of the present paralysis affecting the building industry.

This vacuum, where there should be an impelling feeling of responsibility, this mental lethargy and lack of forethought on the part of a large number of individuals has let the building industry in New York City slip gradually into the condition of com-

plete demoralization revealed by the investigations of the Lockwood Committee.

Similar investigations in other large cities would probably reveal the same loathsome conditions. Who is responsible? There is only one answer. The industry—the *individuals* composing the industry.

NO nation, no industry, can endure in which the individual does no thinking, in which he does not contribute his thought to the mass thought, his will to the mass will, his opinion to the mass opinion.

There are always groups of thinkers—always pitifully small—who can and do lead the unthinking crowd. But such leadership lasts only so long as there is a crowd to follow, and a crowd that will translate ideas and ideals into action. Knowledge is power only when applied. Upon the truth of that assertion rests our whole concept of education.

How many individuals realize that the rent legislation adopted by the special session of the New York State Legislature completely stifled any will there was to build on the part of those who were able to help in satisfying the public's need for housing? The problem was one of getting houses. The legislature closed the door on any possibility of a solution.

We cry out against the railway embargoes, the shortage of cars and the high rates. Does the individual ever ask why these conditions prevail or what the underlying causes really are? No. He "leaves it to George" to get the facts and do his thinking for him.

The building will never be better than it has been, and is, if we do not, all of us, apply ourselves to the improvement of conditions. To do that, we must individually do some straight thinking on the basis of facts. What do you, as an individual, think the trouble is. What do you, again as an individual, suggest as a corrective measure?

Do some thinking, and then write your thoughts to the Editor of this journal, to be used in forwarding the movement for convening the Congress of the Building and Construction Industry.

And if you did not read about that Congress and what it proposes to do, or if you *did* read of it and gave it little thought, get hold of last week's issue of THE AMERICAN ARCHITECT and turn to page 137, read carefully what is written there, and let the Editor know just what you think of the idea and its possibilities.

Do your share as an intelligent individual in a great profession!

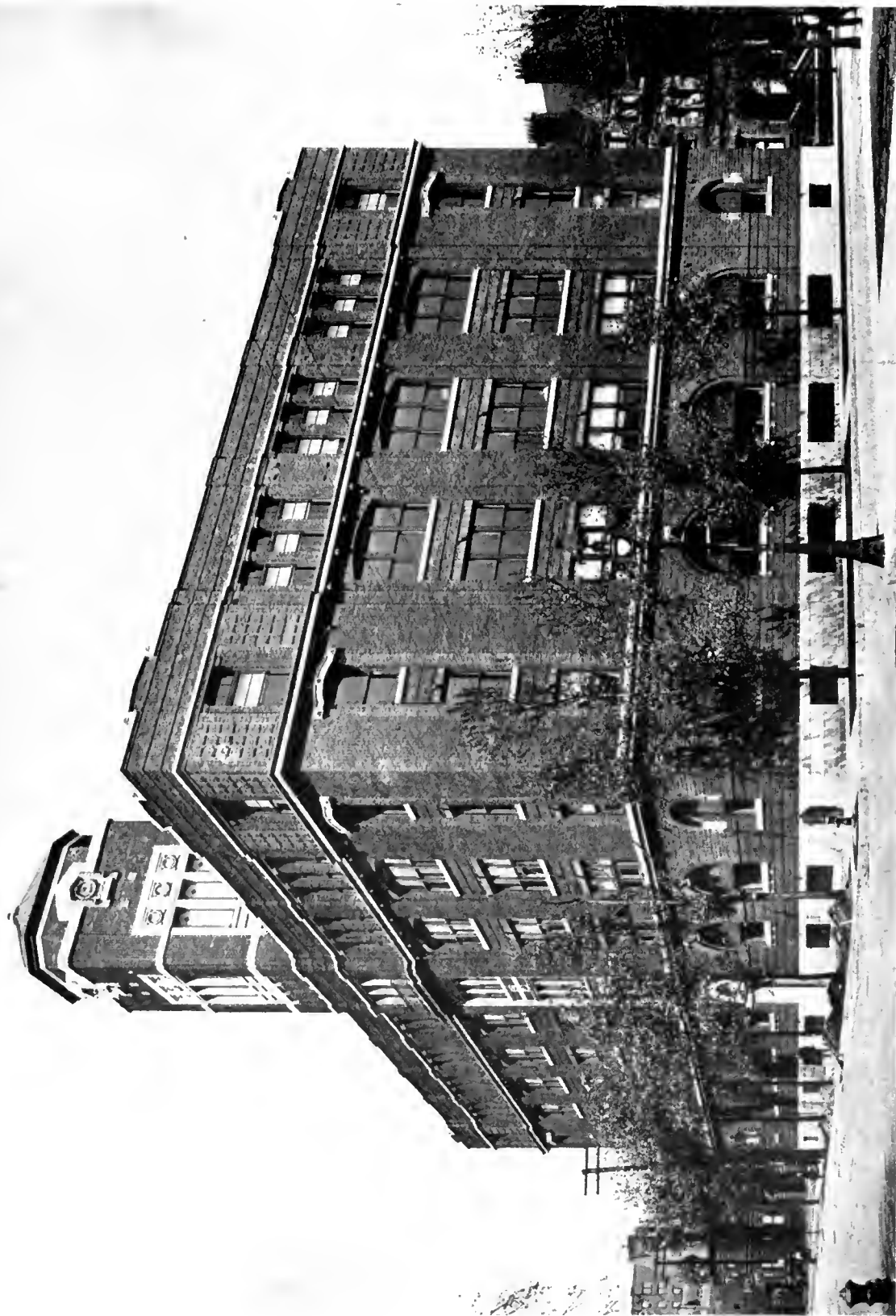

BUILDING FOR THE AMERICAN BOOK CO., CHICAGO
N. MAX DUNNING, ARCHITECT



ENTRANCE DETAIL.
BUILDING FOR THE AMERICAN BOOK CO., CHICAGO
N. MAX DUNNING, ARCHITECT



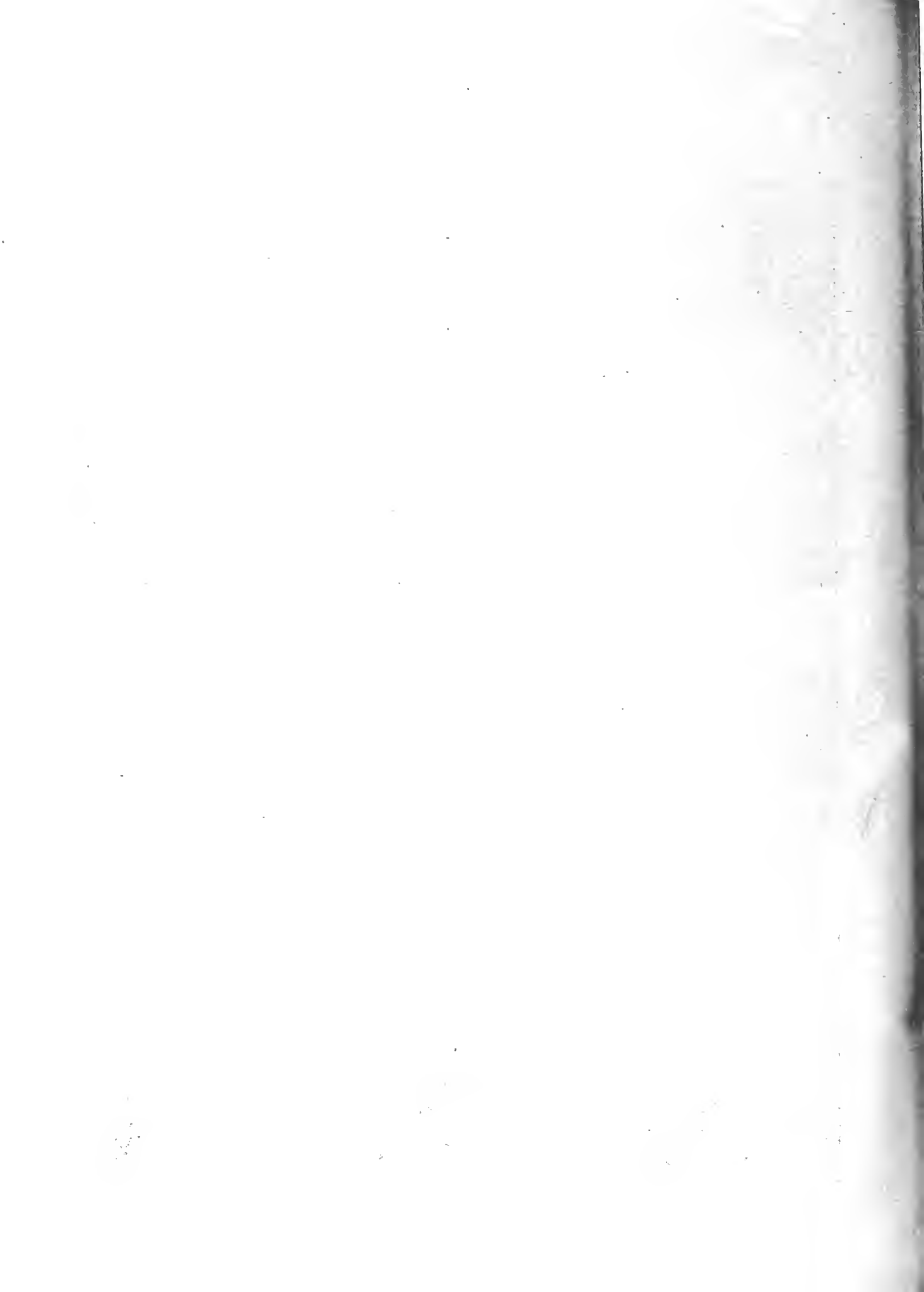



NEWELL MEMORIAL CHAPEL
KENOSHA CEMETERY ASSOCIATION, KENOSHA, WIS.
N. MAX DUNNING, ARCHITECT



INTERIOR, NEWELL MEMORIAL CHAPEL
KENOSHA CEMETERY ASSOCIATION, KENOSHA, WIS.



ABOVE: KENOSHA HOSPITAL, KENOSHA, WIS.
N. MAX DUNNING, ARCHITECT

AT LEFT: DETAIL OF MAIN ENTRANCE





MAIN ENTRANCE DETAIL



EXCHANGE BUILDING
DIXON HOME TELEPHONE CO., DIXON, ILL.
N. MAX DUNNING, ARCHITECT

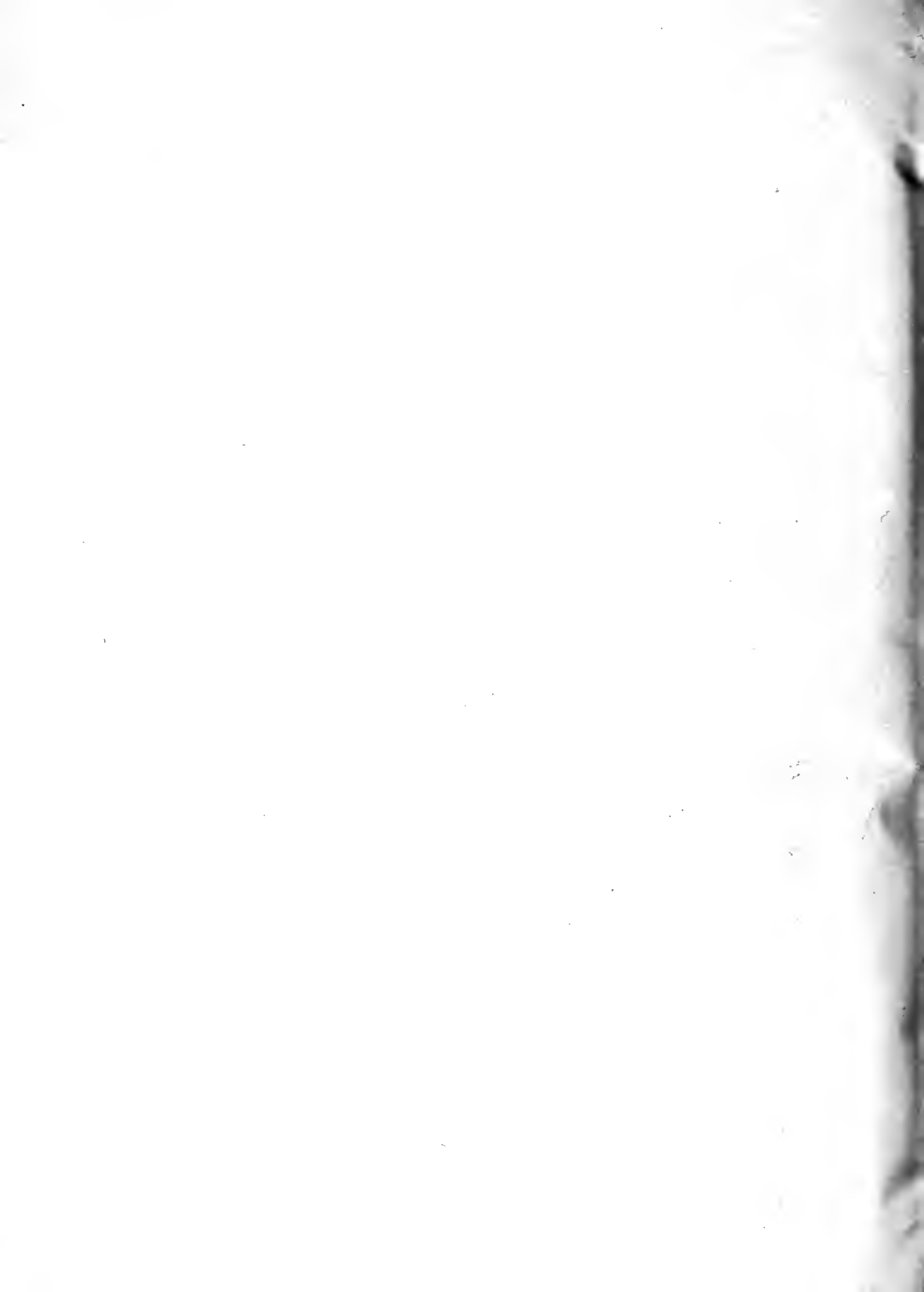

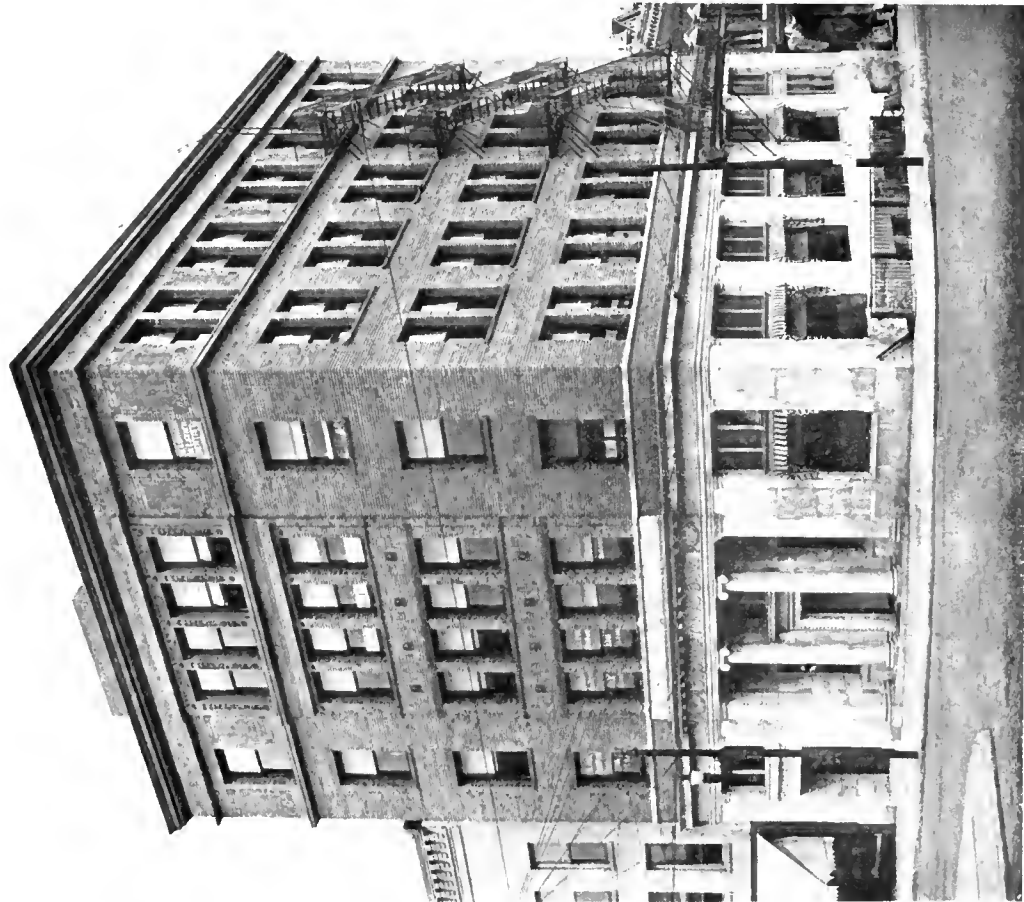

DIXON NATIONAL BANK BUILDING, DIXON, ILL.

N. MAX DUNNING, ARCHITECT

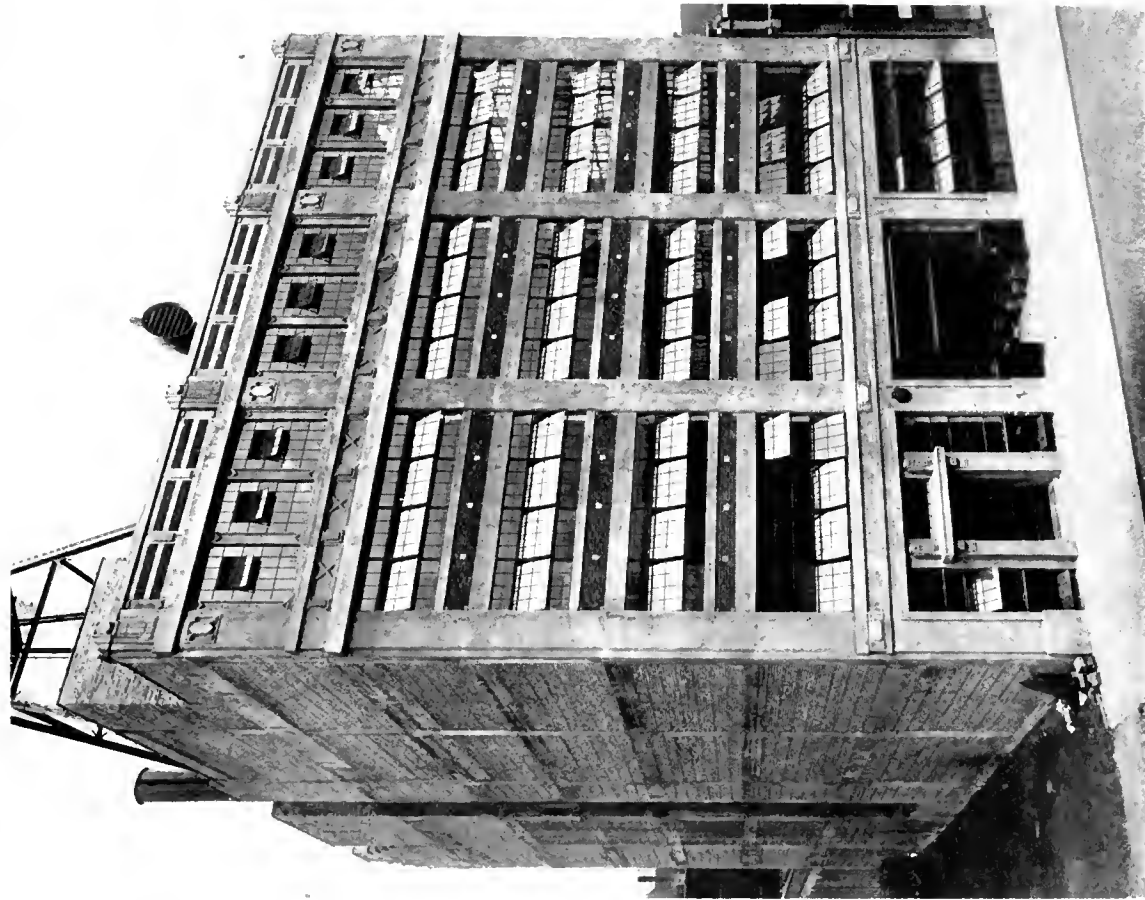

STROMBERG MOTOR DEVICE BUILDING, CHICAGO

N. MAX DUNNING, ARCHITECT

DEPARTMENT OF ARCHITECTURAL ENGINEERING



THE LOOSE-WILES BISCUIT CO. BUILDING, LONG ISLAND CITY, N. Y.
WILLIAM HIGGINSON, ARCHITECT

Modern Practice in Reinforced Concrete Construction

Beam and Girder Construction Exemplified in the Loose-Wiles Building

WHILE the use of concrete in building construction—and by *concrete* is meant an artificial stone produced by processes far more rapid than those employed by nature in the normal formation of rock—dates back to almost ancient times, yet only during comparatively recent years has any attempt been made to supplement this rather brittle substance with steel that it might be enabled to withstand tensile as well as compressive strains.

By forming a combination of steel and concrete an all around structural material has been produced, now termed “reinforced concrete.”

A survey of modern structures built of reinforced concrete must force the admission that a high degree of development has already taken place since the introduction of this material as a real factor in building construction. Engineers of an inventive turn of mind have here found an excellent field in

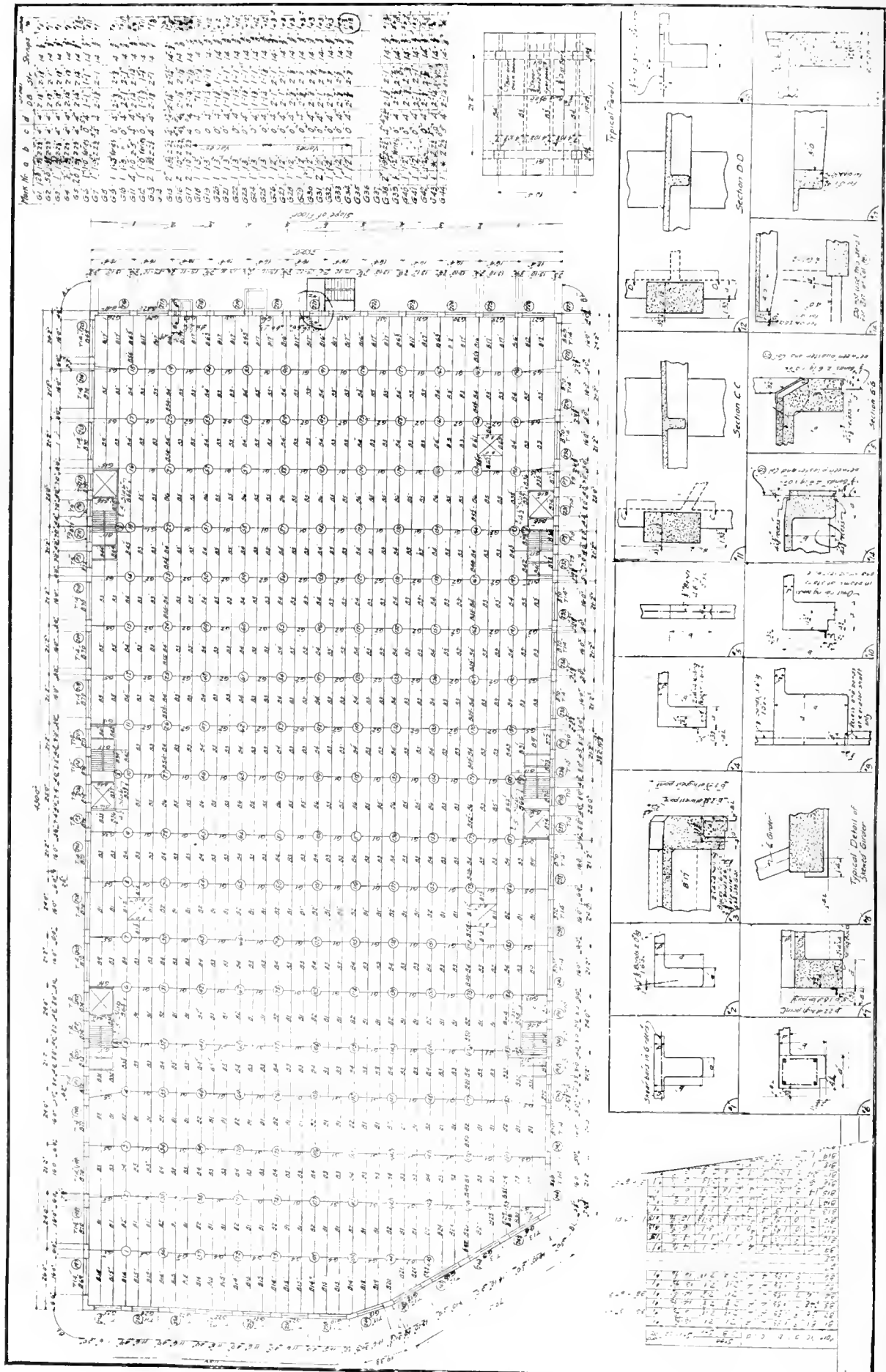

PLAN OF 6th FLOOR
Typical of framing in lower stories

which to work, and the new systems already produced lead one to believe that a yet more efficient use will be made of reinforced concrete in the not distant future. Today we have the results of extensive tests on various systems to guide us in making additional steps in advance.

It is not the purpose of these articles to describe the many special systems of construction which have made use of reinforced concrete, but rather to point out the essential features in the several general lines

to avoid either excessively deep or wide girders. This type is known as beam and girder construction. A building in which such construction was employed, and which possesses certain features of interest is here illustrated.

A later development brought about the girderless floor or "flat slab" type of construction, as it is now more generally termed. This form of construction will be described and illustrated in a later article.

In the consideration of this type of reinforced

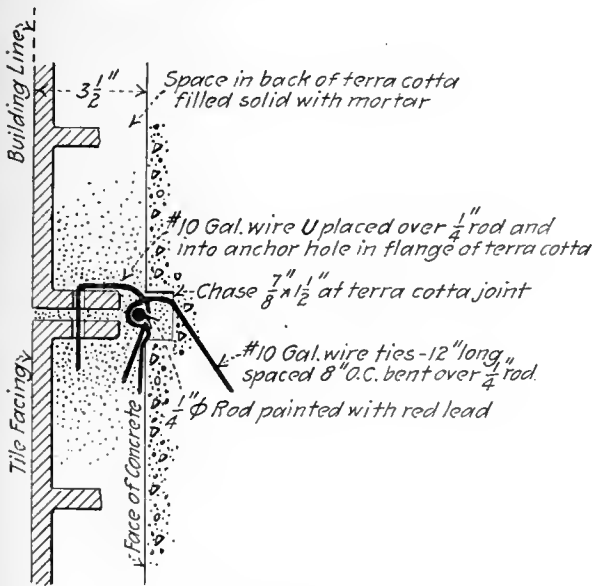

METHOD OF ANCHORING TERRA COTTA TO CONCRETE COLUMNS

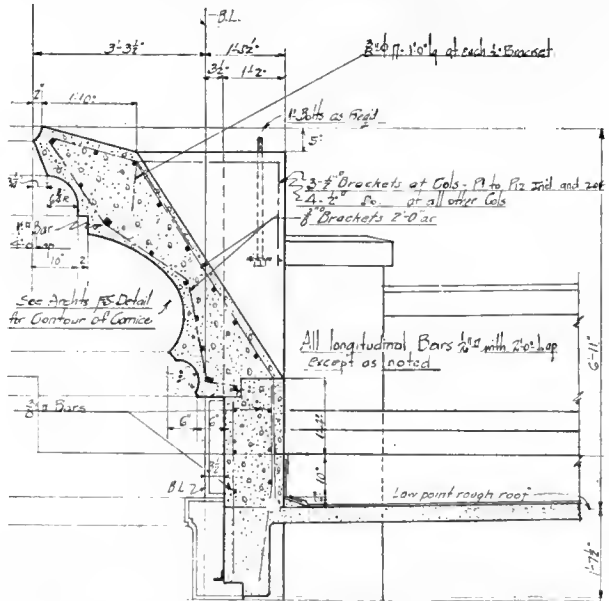

SECTION THROUGH REINFORCED CONCRETE CORNICE

along which reinforced concrete construction has been developed to date.

Precedent has played its part in such work, and we find the first reinforced concrete buildings followed closely steel design, in so far as the arrangement of the structural members is concerned. Spacing of columns, beams and girders differed little from standard practice in steel design, except that where floor loads were heavy it frequently became necessary to resort to closer column spacing

concrete building, reference will be made to the building of the Loose-Wiles Biscuit Company at Long Island City, N. Y., of which William Higginson was the architect. This structure was erected by the Turner Construction Company. It is the largest bakery building in the world, occupying a



VIEW SHOWING SLAB REINFORCEMENT

ground area 430 x 200 ft., and is nine stories and basement in height. A wood pile foundation was used, there being approximately 15,000 piles supporting the structure. In general the floor live loads vary



PROGRESS VIEW
Showing erection of steel columns

from 150 lbs. to 400 lbs. per sq. ft., but in the upper stories, where the English and American bake ovens are located, the live load runs as high as 2000 lbs. per sq. ft.

In this building 360 different kinds of biscuits and crackers are made, one machine alone turning out 7,300,000 crackers of one kind daily. Some 2600 persons are employed when the plant is operating to full capacity.

A framing plan typical of the lower stories is reproduced on page 178. It will be noted that the columns are in general spaced 21 ft. 2 in. in one direction and 16 ft. 4 in. in the other. Each bay is divided into three panels by beams spanning in the long direction. By arranging the girders on the short span the depths of beams and girders are kept

more nearly equal. In this case the typical girder *G1* has a theoretical span of 16 ft. 4 in. and is 21½ in. wide by 26½ in. total depth. The reinforcement consists of four 1⅛-in. square bars and fourteen ⅜-in. square stirrups. Two of these bars are run straight in the bottom and two are run in the top for about one-quarter of the span either side of the center line and bent up so as to be at the top over the support and run far enough beyond the edge of the support to develop the full strength in bond of these bars in order to resist the negative moment at this point. This girder is designed to resist the positive bending moment at the center caused by the concentrated loads from the beams at the third points and the uniform dead load of the girder itself. This moment is reduced to two-thirds



PROGRESS VIEW
Illustrating method of carrying up terra cotta facing

THE AMERICAN ARCHITECT

to allow for the continuous monolithic construction and the section and reinforcement at the support is designed to resist a negative moment equal to the reduced positive moment. It should be noted that the width of this girder is greater than that required to resist the allowable shearing stress of 150 lbs. per sq. in. This is done so as to permit the reinforcing bars to run by on either side of the steel

part of the beam provided its effective width shall not exceed on either side of the beam one-sixth of the span length of the beam nor be greater than six times the thickness of the slab on either side of the beam, the measurements being taken from edge of web."

This provision is generally taken advantage of in the design when beam and girder construction is used.

In the Loose-Wiles building the floor arches in

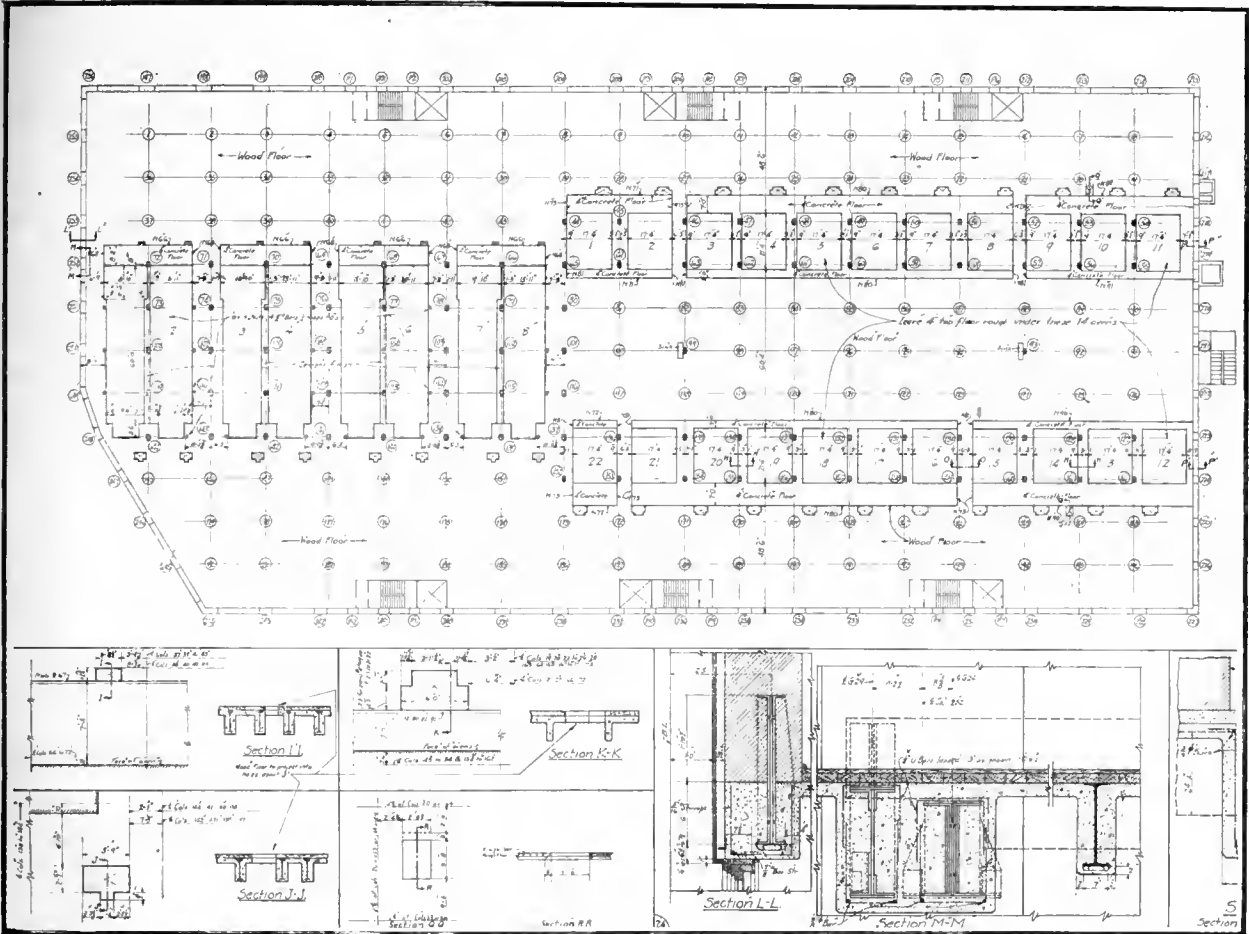

PLAN OF SEVENTH FLOOR
Showing location of English and American bake ovens

column cores. The typical beam B3 is 7"x20½" reinforced with ⅞-in. square bars and fourteen 5/16-in. square stirrups. These bars are placed in a way similar to the girder reinforcing bars above.

In the calculation of the beams the formula $\frac{WL}{12}$ was used to obtain both the positive and negative bending moments to be resisted. The floor illustrated was designed for a live load of 200 lbs. per sq. ft.

The New York Building Code provides that,

"Where adequate bond between slab and web of beam is provided, the slab may be considered as an integral

the majority of the floors are 4 in. thick, reinforced with ⅜-in. square bars 9½ in. on centers. A ½-in. square distributing bar is placed in the center in each case and a 1" x 1" x ⅛" T-bar is carried by cast iron bridges over each beam, this bar serving to raise the slab reinforcement to the top at these points, as shown in the drawing, as well as in one of the photographs.

By many it may be thought that beam and girder construction was now but seldom used, being almost entirely superseded by flat slab construction. This, however, is not the case. Where the floor panels can be arranged approximately in squares, it will

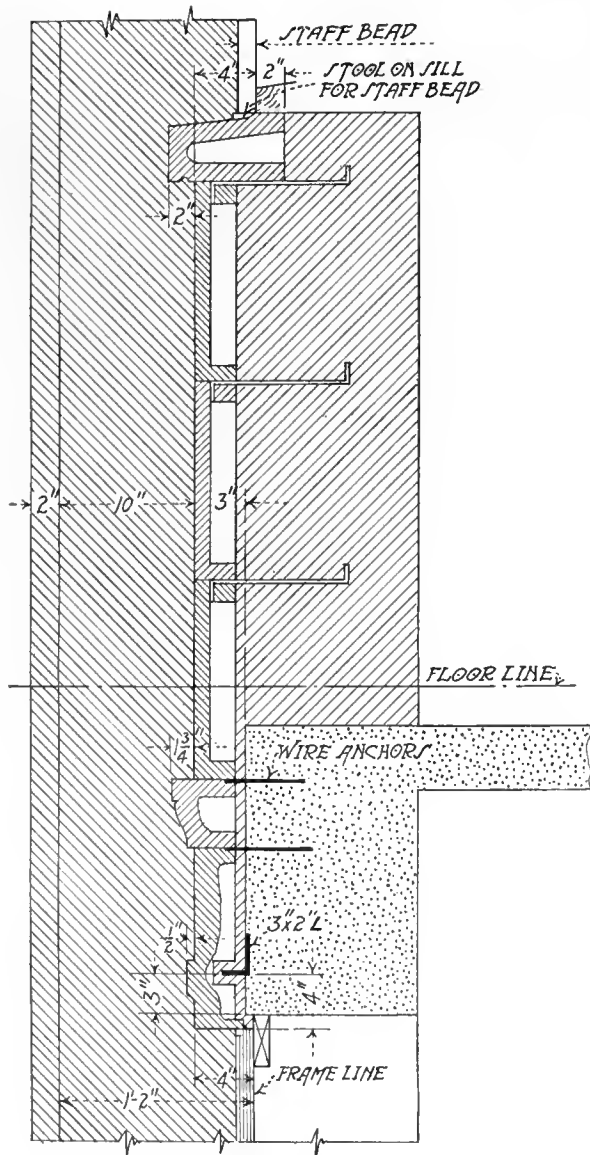

METHOD OF ANCHORING FACING TO BRICK SPANDREL WALLS

often be found that a flat slab design will prove the most economical. There are many buildings in which such an arrangement of columns is not possible. Remembering that primarily the building is erected to house a business, often of an industrial nature, the first condition to be met is the harmonizing of the constructional features with the system of operation to be employed. It will often occur that a certain number of machines of a certain size must be placed in a bay and this will determine the column spacing in that direction. Other features may fix the spacing in the other direction, with the result that rectangular bays are formed. In such cases, the beam and girder type will often prove both

the most satisfactory and economical. In cases where heavy concentrated loads or heavy vibrating machinery are to be supported this type of construction may also prove best.

One of the factors which to some extent at least has tended to limit the height of reinforced concrete structures is the large proportions the columns assume in the lower stories. For industrial buildings up to six stories with nominal floor loading the column sizes will not usually prove objectionable. However, in buildings over this height or those in which heavy floor loadings occur, and also in buildings occupied for office purposes, hotels, etc., it becomes necessary to keep the column sections to minimum size. This can be accomplished in reinforced concrete construction by the use of steel cores, usually fabricated the same as for a structural steel building. In some cases cast iron cores have been used.

By fixing a limit to the size of column, it is possible to make use of reinforced concrete columns until the loads bring the column to the maximum size permissible, and below this level structural steel cores can be used. This was done in the Loose-

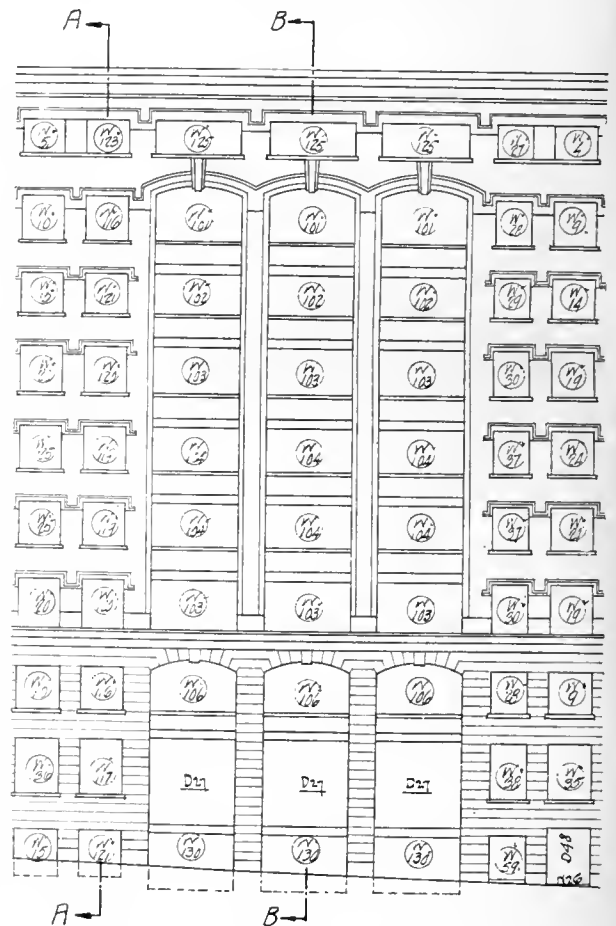

PORTION OF QUEENS PLACE ELEVATION

Wiles building, the steel cores extending from footing to seventh floor level. By resorting to this combination the columns in the first story do not exceed 21½" x 25" in section. These steel columns can be clearly seen in two of the photographs. This is by no means an unusual feature, and seems a logical design under the circumstances, since these columns each carry in the neighborhood of 1000 tons in the lowest story, which load would require a reinforced concrete column of from 3½ to 4 ft. in diameter. Where possible, however, it is more economical to use reinforced concrete throughout.

When steel cores are used it is safe to use a higher unit stress in the steel than would be permissible were the steel not encased in concrete. Most building codes make allowance for this. The New York code, for instance, provides as follows:

"In columns of structural steel, thoroughly encased in concrete not less than four inches thick and reinforced with not less than one per cent. of steel, the allowable load shall be sixteen thousand pounds per square inch on the structural steel, the percentage of reinforcement being the volume of the reinforcing steel divided by the volume of the concrete enclosed by the reinforcing steel. Not more than one-half of the reinforcing steel shall be placed vertically. The reinforcing steel shall not be placed nearer than one inch to the structural steel or to the outer surface of the concrete. The ratio of length to least radius of gyration of structural steel section shall not exceed one hundred and twenty."

Such steel columns, if not so encased would

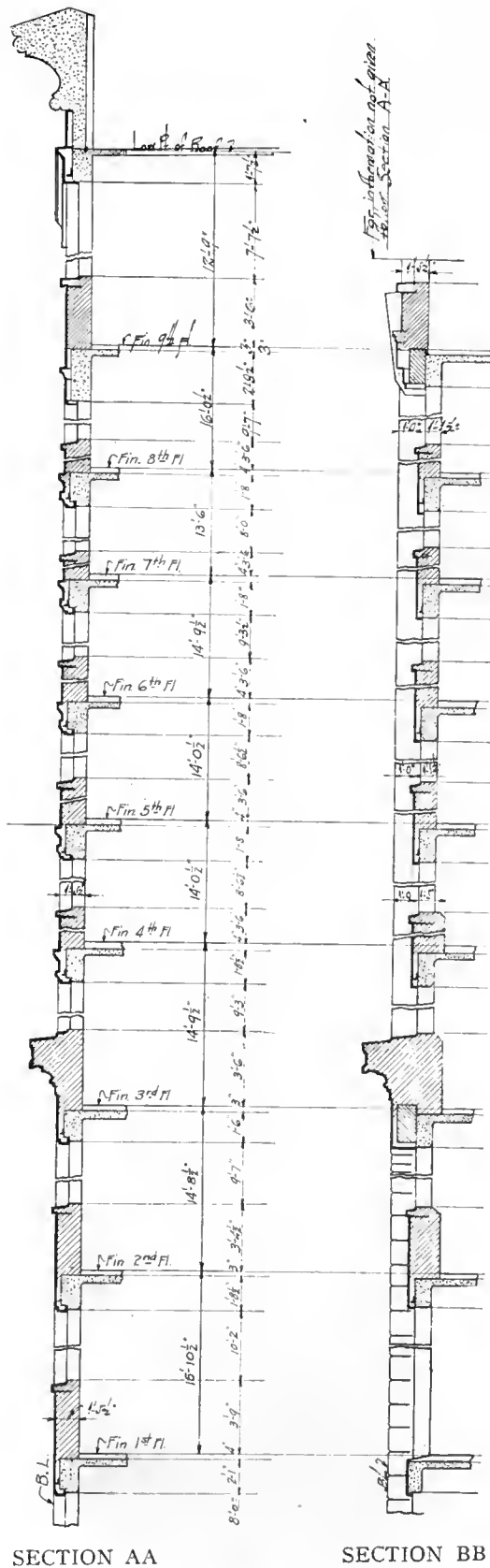

probably have a limiting unit stress of about 12,000 lbs. per sq. in. on the cross sectional area of the steel instead of 16,000 lbs.

The choice of materials for wall construction is largely a matter of individual selection or taste, governed, of course, by local conditions. The wall columns and girders will naturally be of reinforced concrete, and concrete walls, with perhaps some simple decoration, seem the logical selection. However, brick or brick faced with ornamental terra cotta are not uncommon materials. Where a brick or terra cotta facing is used over the concrete wall columns and girders, the detail of anchoring is important.

The walls of the building here illustrated are faced with white glazed terra cotta. The spandrel walls are of brick faced with terra cotta. The method of anchoring the facing is clearly illustrated in two of the drawings showing different wall sections. Sections AA and BB give a general idea of the wall construction while the partial sections to larger scale show the details. The terra cotta facing for the brick spandrel walls is anchored by ordinary galvanized iron strap anchors, while wire ties embedded in the concrete and an angle iron anchored to the concrete hold the tile facing to the concrete wall girders. An inspection of the section taken through a portion of the concrete wall columns will show that here the anchoring of the terra cotta became more complicated.

Horizontal chases $\frac{7}{8}$ " x $1\frac{1}{2}$ " spaced approximately 12 in. apart vertically were formed on the face of the wall columns when they were poured. These recesses are clearly defined on some of the wall columns in the photograph showing the lower stories already faced and the concrete exposed above. Here wire anchors 12 in. long and 8 in. on centers, placed prior to the pouring of the concrete, were embedded 6 in. in the concrete. These wire ties were used to

This building was one of those visited by members of the American Society of Civil Engineers who attended the 1921 annual meeting, and the writer carefully inspected the present condition of the facing, and so far as could be seen, it has "stayed put."

In the majority of reinforced concrete buildings, a troweled finish cement floor is used. However, in some buildings, due to the very nature of the processes of manufacture to be carried on, a wood floor-

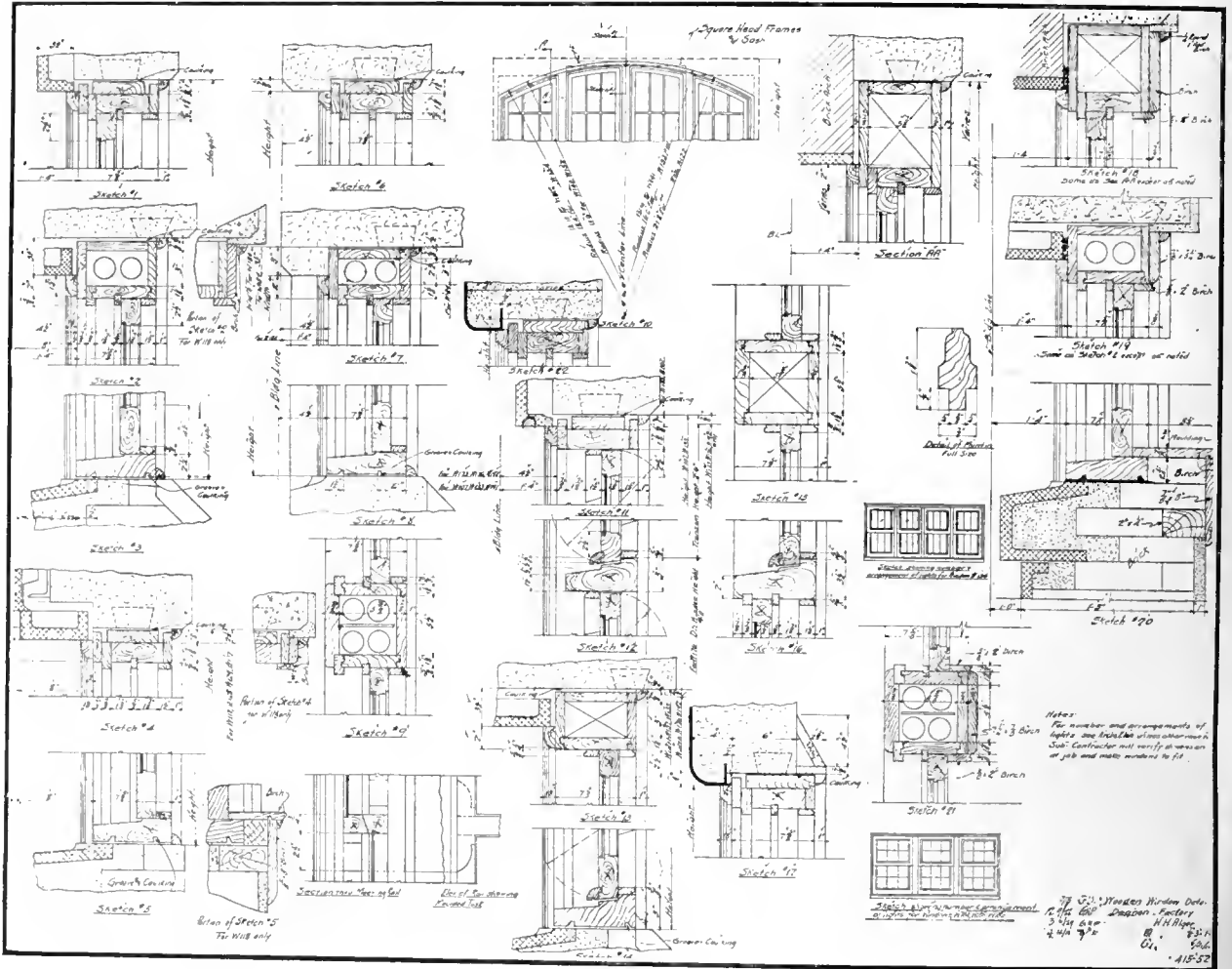

WOODEN WINDOW DETAILS

hook over a horizontal $\frac{1}{4}$ -in. anchor rod. When the tile facing was laid, a wire U was placed through the anchor holes in the terra cotta and this horizontal rod. As the placement of the facing progressed, the space between it and the face of the concrete was slushed in solid with mortar. It will thus be seen that after this mortar had set the facing became securely tied to the concrete structure. As the building has been up some years, ample opportunity has been afforded to show the efficiency of this method.

ing is desired. In the Loose-Wiles buildings most of the floors of which are devoted to the baking and packing of various brands of crackers, a concrete floor was objectionable, and so in these stories wood flooring was used. One of the photographs shows this flooring in process of being laid. On top of the concrete floor arches a thin sand cushion was spread, and splined wood under flooring, 2 in. thick, laid directly on top of this cushion. The planks are fastened together by diagonal nailing. Over this

under flooring the finished maple flooring was laid. It is, of course, important when using this method that the sand be thoroughly dry prior to laying the flooring.

Solid steel sash windows are at present largely used in reinforced concrete structures, and in a later article details of placing this type of window will be described and illustrated.

In the Loose-Wiles building wooden windows were used and the details of construction are shown in one of the drawings. In the second and eighth stories the openings have curved arches, but the window frames have square heads.

A study of the details will prove instructive. Wood nailing strips were embedded in the concrete for fastening both window and head and jambs, and to these the frames were nailed. It will be noted that all frames are caulked. This is an essential feature where wood frames used in reinforced concrete buildings, to insure against excessive air and water leakage.

A reinforced concrete moulded cornice was made use of, a detail of which is shown. This provides permanent construction and is vastly superior to galvanized iron cornice construction.

Due to the special use of this building, extensive ovens had to be installed. These extend from the seventh floor to the roof. One of the illustrations



MONITOR OPEN OVENS
Showing special construction in floors below

shows the manner in which sections of the floor slabs were omitted above the seventh floor to permit the proper construction of the ovens. Attention is directed to the fact that one row of columns just in front of the ovens has been entirely omitted above the eighth floor, making necessary the construction of special long span girders at the ninth floor and roof, shown in part at the left of the illustration above referred to. The peculiar construction necessary to support the ovens is indicated in the plan of the seventh floor. As the loads to be supported under the American or revolving ovens are very much in excess of those usually met with in common practice, the use of reinforced concrete construction under these ovens would have required girders of very considerable dimensions. Therefore, steel girders were substituted for this section of the seventh floor.

In order to permit the greatest degree of flexibility in the operation of this plant, insofar as the baking operations were concerned, the seventh floor construction is so designed that at any time the English or endless conveyor type of oven, numbered from 1 to 8 at the left of the seventh floor plan, may be extended to the right, replacing some of the American ovens, should this seem desirable. On the other hand, the steel construction under the American ovens, numbered from 1 to 22 at the right of the plan, was continued so as to permit the extension of this type of oven so as to replace entirely the English oven, should experience warrant such a change. The floor construction under the English ovens is of heavy reinforced concrete designed to carry in the neighborhood of 1700 lbs. per sq. ft.

These points are brought out to show the possibilities of taking care of exceptional conditions which often occur in industrial buildings.



METHOD OF LAYING THE WOOD FLOORING

Preventing Cracks in Plaster Walls--Part 1

Results of Investigation by the Associated Metal Lath Manufacturers

THE appearance of cracks in plaster walls, particularly in corners where two walls or a wall and ceiling join, has attracted considerable study and investigation in the past for the purpose of determining correct methods of applying lath and plaster so that such cracks might be avoided.

Recent tests have been conducted to show the effect that different arrangements of metal lath have upon the cracking tendency of plaster walls and to determine the best method of application of the lath to prevent cracks. These investigations have been divided into several parts, and what is known as Series A deals with cracks where ceiling and side walls join.

Six different forms of construction were used, namely:

1. Wood lath side walls; metal lath ceiling; metal lath extending 6 in. down side wall; metal lath attachments 6 in. from corner.
2. Wood lath wall; metal lath ceiling; no bend.
3. Metal lath wall; metal lath ceiling; metal lath corner; attachments 6 in. from corner.
4. Same as 3 except attachments are right up to corner.
5. Metal lath wall; metal lath ceiling; joint at corner, not bent over. No. 18 gauge iron ties were once between each pair studs.
6. Wood lath side wall; wood lath ceiling.



SHOWING TEST SAMPLE SUPPORTED ON END STUD



LOAD APPLIED ON CENTER STUD

The samples used in these tests consisted in each case of a full sized section of wall and ceiling. They were made up of three 2" x 4" hemlock studs, spaced 16 in. center to center. The height of the wall was 36 in. and the width of the ceiling portion was 18 in. The sample was 34 in. deep. The plaster was used in the proportion of 2:1 of sand and gypsum plaster. Two coats were applied on the wood lath and three on the metal.

A brief summary of the results follows and shows that metal lath on wall, corner and ceiling with attachments right up to the corner is the strongest construction and permitted the greatest distortion before cracks first appeared.

RESULTS OF CRACK TEST.

Sample No.	Appearance of First Crack Load	Deflection
1	4400	.11
2	4600	.17
3	5200	.22
425
5	3000	.16
610

Current News

Happenings and Comments in the Field of Architecture and the Allied Arts

Paris Prize of the Society of Beaux-Arts Architects

The first preliminary competition of the 14th Paris Prize, open to all citizens of the United States under thirty (30) years of age on July 1st, 1921, will be held on February 26th, 1921.

For particulars apply to chairman, 126 East 75th street, New York City.

Architectural Water Colors

The Department of Architecture of the Massachusetts Institute of Technology has placed on view in the Rogers Building, Boylston street, Boston, a loan collection of architectural water colors by artists of distinction. Guardi, Turner and Ruskin are among the greater names. There are several Winslow Homers and Sargents and there is a little Venetian subject painted by Sargent's mother. Ross Turner, Ralph W. Gray, E. H. Rankin, W. T. Aldrich, Denman W. Ross, F. L. W. Richardson and Charles F. McKim are others of note. The original idea in forming the exhibition was to offer instructive and inspiring material to the students in the school, and it is an example that well might be followed wherever young architects are in training.

Oswald Speir

Oswald Speir, Executive Secretary of National Terra Cotta Society, died suddenly on the Twentieth Century Limited en route to Chicago on business at 6 o'clock Wednesday morning, February 2. The cause of death was acute indigestion. He was in the best of health at the time of taking the train.

A *New Yorker*, he had spent ten years of his life on the Pacific Coast.

Few men had a wider acquaintance among the architectural profession the country over than Mr. Speir. He was a pioneer of the Terra Cotta industry in this country. As a representative and sales manager of the old Perth Amboy company it is not too much to say that without the manufacturer's co-operation he supplied to his friend, Stanford White, the eminent architect, such architectural masterpieces as Madison Square Garden, Judson Memorial Church, the Herald Building and Park-

hurst Church and others might not have been possible. These buildings, endeared to New Yorkers and famous over the world, mark the renaissance of American architecture, in bringing about which Mr. Speir contributed directly.

Oswald Speir was born in New Orleans, La., August 18, 1864. After studying architecture for a year he entered the employ of the Perth Amboy Terra Cotta Company, with whom he continued until 1908, when he moved to Los Angeles to become local manager for the Pacific Coast Terra Cotta Manufacturers, Gladding, McBean & Co. While on the coast in 1918-19, as Vice-President of Pacific Marine and Construction Company, he took a leading part in the construction of concrete ships for the Emergency Fleet Corporation. He came back last June to serve the terra cotta industry with enlarged powers as secretary of the National Terra Cotta Society. Under his administration noteworthy progress has been made in the short time elapsed.

Mr. Speir resided in New York at 26 Gramercy Park. He leaves a wife and four children. He was a member of American Institute of Architects, New York Academy of Sciences, American Ceramic Society. His clubs were: Faculty, University of California; Jonathan, Los Angeles; Cuyamaca, San Diego; National Arts, New York.

Southern California Chapter's Officers

Edwin Bergstrom was unanimously re-elected president of the Southern California Chapter of the American Institute of Architects at the December meeting at the City Club. The other officers elected were: Henry F. Withey, vice-president; R. Germain Hubby, secretary; Robert H. Orr, treasurer; and D. C. Allison, director.

Georgia Architects Organize

The Georgia Chapter of the American Institute of Architects has elected the following officers for the ensuing year: President, Warren C. Powell; first vice-president, P. Thornton Marye; second vice-president, G. Lloyd Preacher; secretary, Arthur Neal Robinson; treasurer, Ernest D. Ivey;

chairman executive committee, Wm. A. Edwards. Mr. Preacher resides in Augusta, and all the other officers live in Atlanta.

Alabama Architects

The annual meeting of the Alabama Chapter was held in Montgomery on January 27. New officers were chosen as follows: George B. Rogers, Mobile, president; Ben Price, Birmingham, vice-president; Eugene H. Knight, Birmingham, secretary-treasurer; Frederick Ausfeld, Montgomery; D. O. Whildin, Birmingham, and Prof. Fred C. Biggin, Auburn, board of directors.

It was decided to have an Alabama Chapter exhibit at the May convention of the American Institute in Washington.

The Chapter will also undertake the collection of a series of slides on Alabama architectural subjects which will be exhibited nationally as well as in England.

The annual prize was renewed to the class in design of the department of architecture at Auburn. Steps are also to be taken looking to a better understanding between those representing architectural art and the general public.

Washington State Society Elects

The Washington State Society of Architects held its annual election in Seattle on December 7 and re-elected the old board of officers as follows: Messrs. Harry H. James, American Bank Building, Seattle, president; Clayton D. Wilson, Mutual Life Building, Seattle, first vice-president; Julius Zittel, Spokane, second vice-president; Watson Vernon, Aberdeen, third vice-president; Richard V. Gough, Okanogan, fourth vice-president; Edgar Blair, Eppler Building, Seattle, secretary, and L. L. Mendel, Empire Building, Seattle, treasurer. The new board of trustees consists of Harry H. James, chairman; Frank H. Fowler, A. Warren Gould, Wm. J. Jones and R. H. Rowe.

Kansas Architects Hold Annual Meeting

The annual meeting of the Kansas Society of Architects was held January 21 at Topeka, Kans. The morning session was devoted to the reports of committees and the election of officers. During the afternoon John H. Kitchen, Kansas City, Mo., talked on "Co-operation Between Architects and Heating Engineers." A general discussion was held on "Should the Basis of Charging for Archi-

tectural Services Be Changed?" The speakers at the banquet in the evening included Tom McNeal, Topeka; Frank A. Slack, Beloit; Lorentz Schmidt, Wichita, retiring president; Bishop James Wise, Topeka. W. E. Glover of Topeka was the toastmaster.

The following officers were elected: President, W. E. Glover, Topeka; vice-president, Ed. Forsblom; secretary and treasurer, J. S. Stookey, Ottawa. Two new directors are C. W. Squires of Emporia and Cecil F. Baker of the faculty of the Department of Architecture of the State Agricultural College at Manhattan.

Wichita Architects Hold Election

The annual meeting of the Wichita (Kans.) Association of Architects was held January 20, when the following officers were elected: President, Ed. Forsblom (re-elected); vice-president, Godfrey Hartwell; secretary-treasurer, Glen H. Thomas. Plans were advanced and discussed for the establishment of a series of talks and discussion pertaining to architecture, to be given at the society's regular meetings. Various outside concerns or their representatives will be invited to talk before the meetings as well as the members.

Virginia Chapter, A. I. A., Names Officers

The Virginia Chapter of the American Institute of Architects held its annual meeting January 18 at the Jefferson Hotel, Richmond, Va. The following officers were elected: President, Fiske Kimball, University of Virginia, Charlottesville, Va.; vice-president, John Kevan Peebles, Peebles & Ferguson, Norfolk, Va.; secretary and treasurer, Charles J. Calrow, Calrow, Wrenn & Tazewell, Norfolk, Va.

Sargent Returns to Boston

John S. Sargent has returned from England and will continue his work on the decorations for the rotunda of the Museum of Fine Arts.

For a National Arboretum

A resolution for the establishment of a botanical garden and arboretum of not less than 1,000 acres near Washington, D. C., for the purpose of growing and classifying all varieties of trees and plants available to American horticulturists, was passed unanimously at the annual convention of the New England Nurserymen's Association at the American House, Boston. E. F. Coe is secretary.

The Ricker Library of Architecture

There has come to us an illustrated booklet of some seventy pages published by the Department of Architecture of the University of Illinois.

This is replete with interesting information on the early literature of architecture and modern architectural books. One chapter gives a comprehensive list of works on architecture recommended to students of architecture and available in the Ricker Library of the University of Illinois.

For a Omaha Art School

Introduction of a bill providing for incorporation of a board of trustees for an institute of teaching and learning, to be devoted chiefly to art, revealed plans for the construction of a magnificent fine art school by Mrs. George A. Joslyn. Property from Twenty-second to Twenty-fourth and Dodge streets probably will be used for the site of the school, which is expected to represent an expenditure of from \$1,000,000 to \$3,000,000.

Plan Permanent Buildings for 1926 World's Fair

Permanent buildings rather than gaudy temporary structures are advocated by members of the art jury of Philadelphia for the world's fair contemplated in 1926 on the 150th anniversary of the signing of the Declaration of Independence. Already ambitious plans have been proposed for an exposition unequaled by any heretofore held anywhere.

Our Imports of Art Works

In the eleven months ending with November the United States imported paintings, statuary and other works of art to the aggregate value of \$25,782,842, as against \$17,579,291 in the same eleven months of 1919 and \$6,730,650 in 1918. The importation, contrary to general belief, was not as great as in the year or two before the war. During the same eleven months of 1913 our imports of such articles amounted to \$29,273,341, and in 1912 to \$53,286,218.

Philadelphia Architects Co-operate with Labor

Mr. D. Knickerbocker Boyd, former Secretary of the Institute, conferred with the council of the *Associated Building Trades for Philadelphia and vicinity* (composed of all branches of the industry

except carpenters) and requested opportunity to address that body on the subject of bettering conditions in the building industry, which request was granted. He urged the need of closer co-operation between the various elements in the industry, that the mechanics might know better the aims of the architect, and that the architect might help to create in the mechanic a keener interest in his work and in the results sought for in the architect's designs, to the end that they might all help to develop themselves as instruments of service for the good of the industry.

He suggested that the Council provide opportunities for lectures on the crafts, plan reading, etc., and assured them of the co-operation of architects in such an undertaking.

The bricklayers promptly responded to the suggestion and under Mr. Boyd's active leadership a meeting was held at which a number of architects addressed the men, and offered their assistance and, as a first definite step in the program, a plan reading class was started. This was conducted by Mr. Victor D. Abel, architect, every Thursday night, starting with an attendance of about 100 men, which gradually increased to the capacity of the hall.

Instruction was given in the reading of plans, the meanings of indications of materials on drawings, dimension lines, the placing of windows, partitions, the working out of stairways and the relation between the drawings and the specifications.

In addition to this class Mr. Boyd arranged for speakers at as nearly as possible every regular weekly meeting of the union, with subjects of interest to the journeymen who were present to the extent of three or four hundred at each meeting, these talks being followed frequently by interesting open discussion.

Hotel Entrances

The big hotels of New York can no longer apparently afford to devote their fronts to displaying their purpose. One of the largest on Broadway is about to rip out its first floor and convert the space into fine shops. Thus the ambitious hostleries of Gotham promise to imitate a fashion long prevalent in the West, which has the virtue of preventing the interruption of the continuity of a shopping district. Hereafter, regretfully, the monumental character of buildings in those parts of the metropolis devoted to the retail trade of the city is not likely to be regarded. The architects will perhaps have to devote their skill to other parts of the city, where the tendency to lift the eyes above the level of a shop window is more pronounced than on Broadway or Fifth avenue.

Art Appreciation Lacking

A lack of appreciation by Bostonians of the Museum of the Fine Arts and its treasures in statuary, ceramics and paintings was a subject of comment in the annual report of Morris Gray, president of the trustees of the Boston Museum of Fine Arts.

In that city of 748,000 persons, with a reputation as a center of culture, he pointed out that the visitors to the art galleries last year were only about one-third of the number of inhabitants.

Historic French Village Has American Aid in Memorial

The municipality of Barbizon, deep in the Fontainebleau forest and famous for its association with artists of the past and present, has, it is learned in special press dispatches, joined efforts with a committee of Americans for the construction of a monument to the French and American soldiers fallen in the war.

The French sculptor Revillion has been commissioned to execute the memorial which he has offered gratuitously. The townsfolk have contributed 8,000 francs and the American committee has organized to raise 15,000 francs needed to complete the work. The monument will be placed in the center of the village on ground formerly owned by the painter, Theodore Rousseau, and near the chapel.

The artist proposes to mount a bronze bust of the "Gaulois" on a rustic shaft formed of rocks from the forest. It will bear a plaque inscribing the names of Barbizon's sons killed in the war and a palm leaf and ribbon with the names of the French victories, Marne, Verdun, Rheims, Alsace and Lorraine. The general aspect will be in harmony with the quaint charm of the village so intimately linked with the lives of Millet, the painter, and Barye, the sculptor.

The American committee is composed of Ridgeway Knight, president; Sidney B. Veit, secretary and treasurer; Alexander Harrison, Paul W. Bartlett, George Howland and Dr. A. L. Hipwell. The proposed dedication will be: "This monument was erected by subscription donated by the citizens of Barbizon and our American friends."

Rue de Rivoli Wants Skyscrapers

To make the Rue de Rivoli into a street of skyscraper apartment houses is the latest proposal offered as a remedy for the housing shortage in Paris, according to a recent press despatch. The street was built one hundred years ago, and the law which then compelled builders not to exceed a uniform height is still in force. The first step, then, will be to get

rid of the law, and that in itself is likely to take considerable time.

Architects say that the houses as they stand can easily support several more stories, and the intention is, if a law giving the necessary powers is passed, to make the buildings of the whole street for a distance of more than a mile of uniform height. As it is now, the buildings are only four stories high. As the street faces the Tuileries Gardens, with houses only on the north side, the proposal, it is argued, might very easily be carried out without injuring the appearance of the famous street.

In view of the constantly increasing population of Paris and the limitation of possibilities of spreading outward, the need for buildings is beginning to be pressing. The authorities are likely, however, to prevent any building which would injure the beauty of the city.

Personal

J. A. Pitzinger has opened an office for architectural practice in Dallas, Texas, 607 Insurance Building. He has discontinued his connection with the architectural department of the General Motors Corp.

Joseph Hudnut has moved his office from 41 Union Square to 51 West 10th street, New York City.

Louis D. Grubb has moved from New York to Register Building, Room 20, Wheeling, W. Va. Manufacturers' information is desired.

G. Lloyd Preacher has admitted to partnership George Harwell Bond, J. F. Wilhoit and Nicholas Mitchell to practice under the name of G. Lloyd Preacher & Co., Healey Building, Atlanta, Ga., and Masonic Building, Augusta, Ga.

Clarence T. Myers, architect, and Kenneth D. Coffin, architectural engineer, have organized for the practice of their profession at 412 Traction Terminal Building, Indianapolis.

The architectural practice formerly carried on under the firm name of Bollard & Webster, 520 Paxton Bldg., Omaha, will be conducted in the future by James R. Webster at the same address.

Stiles S. Dixon has opened an office for the practice of architecture in the Horne & Ray Building, Fayetteville, N. C. Catalogues and samples desired.

T. C. Desmond Co. have removed to new offices at 26 Beaver street, New York.

Health Commissioner Invokes Millionaires

Dr. Royal S. Copeland, speaking recently before the Educational Alliance Forum, New York, said there is no city in the world where housing conditions are as bad as here. He said there are 100,000 more families than houses in this city which means that 100,000 families are living with other families.

Dr. Copeland told of having had a conference with fifty millionaires—bankers, trust company directors and financiers generally—and said that as a result a committee had been appointed by these men to look into the housing question with a view to furnishing more homes.

He stated further, that there are two classes who do not want to see more houses built—the real estate men and the savings banks.

He said there are \$2,000,000,000 in the savings banks of this city, and one quarter of that sum would be sufficient to relieve the housing conditions.

School Building Program for New York

A school building program of \$65,000,000 has been adopted at a meeting of the Board of Education and will be submitted to the Board of Estimate of New York with the request that action be taken as soon as possible. The lack of schools is creating an acute situation.

LeBrun Scholarship Award

The jury in the LeBrun Scholarship Competition for 1920-21, conducted by the New York Chapter A. I. A., has made the following awards:

Traveling Scholar—Oliver Reagan, New York City.

First Honorable Mention—Robbins L. Conn, New York City.

Second Honorable Mention—Edward S. Lacosta, New York City.

Third Honorable Mention—Charles J. Irwin, Brooklyn, N. Y.

The following men, whose names are given alphabetically, were mentioned by the jury for the excellence of their work:

Howard Stanley Atkinson, Philadelphia, Pa.

John S. Burrell, New York City.

Louis Fentnor, New York City.

J. Harold Geisel, Philadelphia, Pa.

Owen L. Gowman, New York City.

Carl W. Lason, Boston, Mass.

Benjamin Moscowitz, New York City.

John G. Schuhmann, New York City.

Edgar F. Stoeckel, New York City.

The interest in the competition was very gratifying, forty-one sets of drawings being presented, representing thirteen states, widely distributed throughout the country.

Publicity by Contractors

Instead of plastering a building job with a lot of signs advertising various sub-contractors, the general contractors in a number of cities are displaying one big sign containing the names of all the sub-contractors on the project. This new departure not only makes for neatness, but it gives all the concerns connected with the job an equal amount of publicity.

Hudson River to be Bridged

Papers of incorporation have been filed in Albany for the Hudson River Corporation. That is an important step toward the realization of the cherished dream of many years—the spanning of the Hudson and the connecting of Manhattan and New Jersey by a great bridge, the river span of which will be more than double the length of the river section of the old Brooklyn Bridge.

The entire plan is estimated to require seven to eight years' time and a total investment of about \$200,000,000, of which approximately one-half will be represented by the bridge itself.

The colossal structure will hang suspended from towers higher than the apex of the Woolworth Building. The centre of its central or river span will be 165 feet clear above the surface of the water, as compared with 135 feet between the river and the middle span of the older structure. The new bridge is expected to accommodate fourteen railroad tracks in all, four on its upper deck and ten on its lower, and to have a traffic capacity of 600,000 persons an hour, as compared with 700,000 for all four of the East River bridges combined, which carry twenty-four tracks in all. The Hudson River bridge is to accommodate 12,000 vehicles, which is equal to the combined vehicular capacity of the Brooklyn, Manhattan, Williamsburg and Queensborough bridges combined, and on its upper deck will sustain 40,000 tons of vehicular freight by rail and truck.

Gustav Lindenthal, the well known bridge builder, is author of the present plan and will continue to be identified with it as engineer-in-chief.

Weekly Review of the Construction Field

With Reports of Special Correspondents in Regional Centers

World Situation

RUSSIA continues to show stability, though no one speaks encouragingly of Russian trade. The Bolsheviki apparently have the situation well in hand.

Austria and the Balkans show little improvement. Conditions in Austria are desperately bad, due fundamentally to the political severance of Vienna from the territory of which it has been the industrial as well as political center. The immediate problem is to get the population of Vienna through the winter. Hungary, Roumania, Bulgaria and Jugo-Slavia are largely agricultural territory. Treasuries and food stocks are low, but there are fortunately no great cities to be provided with supplies.

Italy has quieted her most alarming disorders. Her treasury is in improved condition as a result of new taxation; the revenues of January, 1921, are reported as three times those of January, 1920. The note circulation of the Bank of Italy on October 10, 1920, was 15,238,000,000 lire, against 14,445,000,000 a year before, and 1,556,000,000 in 1914. With the increased revenues, this inflation should cease.

Poland has been prostrated by the struggle with Russia. The industrial and financial situation is very bad, with the currency depreciated almost to the vanishing point by the enormous issues of the past year. Ordinarily almost self-supporting in food production, Poland required importations in 1920, and socialistic experiments in state management of industries have added enormous confusion, the state railways having five times as many employees per kilometer as the roads of western Europe. No figures are available regarding commercial activity.

GERMANY is still unsettled and agitated. The 1920 crops were not good. The printed money has demoralized the currency and foreign exchanges. The railroads are a severe burden on the public treasury. Coal is lacking, but some improvement has recently been shown—the most hopeful sign of 1920.

The overshadowing problem is naturally that of indemnities. No sane man would think of predicting anything with regard to this matter.

Belgium and France show substantial progress in industrial recovery. Belgium, before the present depression, was back, on the whole, on a pre-war production basis. In France remarkable progress has been made. The first ten months of 1920 showed the value of imports to be 29,784,000 francs, as

against 27,397,000,000 in 1919, and exports for the same period were 18,890,000,000, against 7,733,000,000 in 1919. Production of coal is increasing. A new internal loan has recently been successfully floated, aggregating 50,000,000,000 francs. By the aid of this the government has been able to reduce its indebtedness to the Bank of France to such an extent that the note circulation of this institution is lower than it was a year ago.

Great Britain has passed through several grave disorders, notably the coal strike, the settlement of which was the most reassuring sign in the British industrial situation. At the close of 1919, the government announced that the outstanding issue of exchequer currency notes, above cash reserves, would not be permitted to exceed £320,600,000 in the year 1920, and that pledge was observed. The gold stock of the Bank of England on December 1, 1920, was £124,991,291, against £91,790,369 on that date of 1919. On December 1, 1920, the adverse balance in foreign trade had been reduced about \$600,000,000.

(Special Correspondence to THE AMERICAN ARCHITECT)

CHICAGO.—Chicago's building apathy continues here but there is a sign of improvement. The most encouraging harbinger of better days is the constant discussion of the great need for building. In this discussion, newspapers, bankers, contractors, homeowners, flatdwellers—everybody, seems to be taking part. It seems logical to expect, out of all this foment and discussion, a revival of building on an important scale.

Point is given to the need for homes and apartments by the battling back and forth between apartment owners and apartment dwellers. With the approach of May 1—Chicago's chief moving day, the battle becomes more acute. Renters say that the customary rule which permits sixty days in which to decide whether the occupants desire to retain an apartment or give it up is no longer allowed, but that spot judgment and next to instant decision is now insisted upon and that apartments which go under new lease beginning May 1 are to be rented at even higher rates than now prevailing, although flatdwellers have hoped that the peak had been reached and that moving day might witness some decline in rental values.

To offset rent raising, the number of panaceas that are being offered is large. There has been the suggestion to make apartment buildings public utilities

THE AMERICAN ARCHITECT

by special legislation and thus place them under the domain of the public utilities commission. Another plan, just now earning important headlines in the newspapers, is a plan to reassess apartment property valuations on the basis of revenue and thus increase the taxes of the landlords who are increasing their rents.

This plan meets with high favor with the apartment dwellers who having believed themselves gouged are anxious to see the gouge applied elsewhere, but the sophistry of the idea is being pointed out by less heated economists who explain that the suggestion really invites higher rents because it provides a method for a profiteering landlord to find absolution for his greed and thus relieve his conscience of any load that might otherwise accrue.

VERY naturally the landlords have their grievances, too, what with higher janitor services and more expensive upkeep, expensive decoration and all the et ceteras that go to cut the revenue of the apartment owner. Back and forth like a vehement contest of battledore and shuttlecock the argument goes, with more buildings the only possible way out of the situation, as far as the best industrial thought in Chicago is concerned.

Building permits continue to show no great preparation for apartment buildings, however, and the time is now getting so near the building season that if a building boom comes it will come with such a spurt as to unsteady conditions once more, just as they seem to have reached a fairly stable state.

A permit of interest, however, is that issued this week for the new Federal Reserve Bank Building, already in course of construction at La Salle street and Jackson Boulevard. The permit explains that the building will have four underground floors, the largest number of sub-basement floors in any of Chicago's buildings.

The building is to be 250 feet high. Because of the height of the main banking floor, the building will have only eighteen stories, but it will be almost as high as its next door neighbor, the Continental & Commercial Bank Building, which has twenty-one stories.

Among other building items of interest just now is the announcement that the Wrigley Building, Chicago's most conspicuous skyscraper will be finished ahead of schedule in spite of the delay incident to present day construction. The building was scheduled to have been completed by May 1, but the indications are that April 1 will see the structure finished, at least to a point where occupancy will be possible. As a matter of fact a board of directors of the Wrigley organization met in formal session in the building last week. The Wrigley Building was be-

gun in March, 1920, and will cost when completed in the neighborhood of \$3,000,000, which is a million dollars in excess of original estimates.

THE labor situation in Chicago and the middle west is showing some improvement. Wage schedules have not been lowered, but a greater individual efficiency is now noticeable in practically all building lines. Officials of a millwork cost bureau announce that 100 per cent. efficiency is now being received in the millwork industry and this testimony of better working morale has its echo in many other building lines.

The lumber and materials situation is but slightly changed from a week ago. Lumber is in very slight demand as far as spot purchase is concerned, though inquiry is showing a gradual gain. Wholesalers and manufacturers take this added inquiry to mean that there are better days ahead in the industry and that spring building may cause an improvement in prices. Manufacturers now claim that lumber is the cheapest of all building materials and is the one factor in the building complex which has satisfactorily readjusted itself to normal prices and conditions.

In materials, other than lumber, there have been some recent revisions. Wallboard, cement, plaster, sewer pipe, lime and hollow tile are items that have felt the shading of the readjustment period, reductions having been made without particular regard to manufacturing costs with an idea of stimulating building.

Some of these materials which enter into road construction as well as home building are expected to be favorably influenced by good roads building which is being discussed now with the idea of early activity. Illinois alone has sixty millions in bonds to be devoted to better roads as soon as construction costs are slightly lower.

Prices in lumber and materials are about as follows in the Chicago market:

(Special Correspondence to THE AMERICAN ARCHITECT)

SEATTLE.—With eastern middlemen quoting off sheets with stock that is believed to have been placed in their hands by outside mills and weakness in the fir lumber market, building conditions suffered a slight setback on the week as a whole.

While the quotations on sheet metal such as is used in building equipment was more in spots than of a general nature, the general market is of so peculiar a temperament that buying orders were checked down. It seems to be one of the weaknesses of the present attempt to steady prices that as soon as confidence is restored in the rock-bottom price tendency of a certain commodity, immediately thereafter some minor agency hurls a value-trimming

THE AMERICAN ARCHITECT

grenade and the situation is once more precipitated. This has been so repeatedly in fir lumber, and now it is happening in steel.

Jobbers are directing that no more sheets be shipped by water owing to the moisture difficulty. The all-rail rate from Pittsburg is \$1.66½ per hundred pounds, against \$1.13 by rail to the seaboard and water to Puget Sound, to which is added insurance and wharfage which brings the total to \$1.25. The conditioning required on arrival practically offsets the difference, and jobbers are less inclined to take advantage of the theoretical rate by water.

The Corporation price holds in all sales of pipe. Stocks are as near to normal as desired under the uncertain spring building commitments. Three-fourths and halves are now about normal at warehouses.

Jobbers report collections fair both under the trade acceptance plan and open accounts, which is taken to forecast a brisk demand for building essentials.

There is plenty of cement, roofing, plaster wall board and brick. So far as the Pacific coast section is concerned, the cement shortage of the past year is over. The four plants of the state are operating full time.

Red cedar shingles have declined to the point where they are admittedly in direct competition with patent roofing, and jobbers in roofing report a decrease in the demand. Shingles beginning with resumption of cutting on Feb. 1 are being packed on the "square" basis, twenty shingles deep on both ends, four bundles to the square. Quotations to the trade today are \$2.15 for clears and \$1.95 for stars.

Conferences between officers of the Associated Industries, or the "American" or open-shop organization which comprises 95 per cent. of all employers in this territory and labor leaders during the week resulted in the announcement that building in this city can be done this season at 30 per cent less than last year.

Master Builders announce that with the new lower wage scale in the building trades effective this week that many building projects for Seattle, approximating \$35,000,000, can now be undertaken. Architects in summarizing the needs of Seattle point to several Class A business, office and apartment buildings, factory buildings, warehouses and cold storage properties. It is felt certain that with a season's minimum wage established investments in the city will reach a total not approached since before

1914. The Master Builders' Association includes 66 leaders in this work in the city. On the new scale carpenters will get \$6.40, building laborers \$4.80, common labor \$4, cement finishers \$6.40, mortar mixers \$5.60, hoisting engineers \$6.40 to \$7.20 and structural iron workers \$7.20. These trades are the leading ones with which Master Builders have to deal.

Fir lumber declined slightly, with common dimension selling to the trade at \$11. There are proportionate weak spots in vertical grain flooring, but other building sizes are steady. There is little eastern enquiry.

(Special Correspondence to THE AMERICAN ARCHITECT)

BOSTON.—Although there is still considerable irregularity in the general business situation in New England, the improved textile and general industrial situation here promotes the growth of confidence mentioned in recent reports.

When you look around for signs that the business tide is beginning to rise, numerous bright spots come to your attention, especially in the textile and shoe and leather trades. These were the first to feel the lack of public interest last Fall and are the first to recover under a stimulated demand for new goods. In textiles, it required only belief that liquidation in prices of goods and raw materials had run its course to bring in new orders. The best opinion in the trade is that liquidation in cotton goods is nearing the end of the run. The revival, therefore, is believed to be genuine and not artificial or transitory. Although every branch of the cotton goods industry is not yet involved, mills making gingham, sheetings and the like are very active. For instance, one large distributing house states that its volume of bookings on spring business is the largest in its history. Reports that several mills are to begin a night shift to take care of incoming orders is a straw indicating the direction of the winds.

Statistics of building and engineering operations in New England show that contracts awarded during the week ending Feb. 1st, 1921, amounted to \$1,189,500 as compared with \$2,144,000 for the corresponding period in 1920; \$233,000 in 1919; \$2,049,000 in 1918; \$1,793,000 in 1917; \$1,479,000 in 1916 and \$947,000 in 1915.

The strike of the 30,000 building mechanics still holds up every building operation of note in Boston and vicinity. It is expected that a settlement will come before the end of next week.

frühling 18 16 2357.



CHURCH OF S. MARIA DELLA SALUTE, VENICE

THE AMERICAN ARCHITECT

VOL. CXIX

WEDNESDAY, FEBRUARY 23, 1921

NUMBER 2357

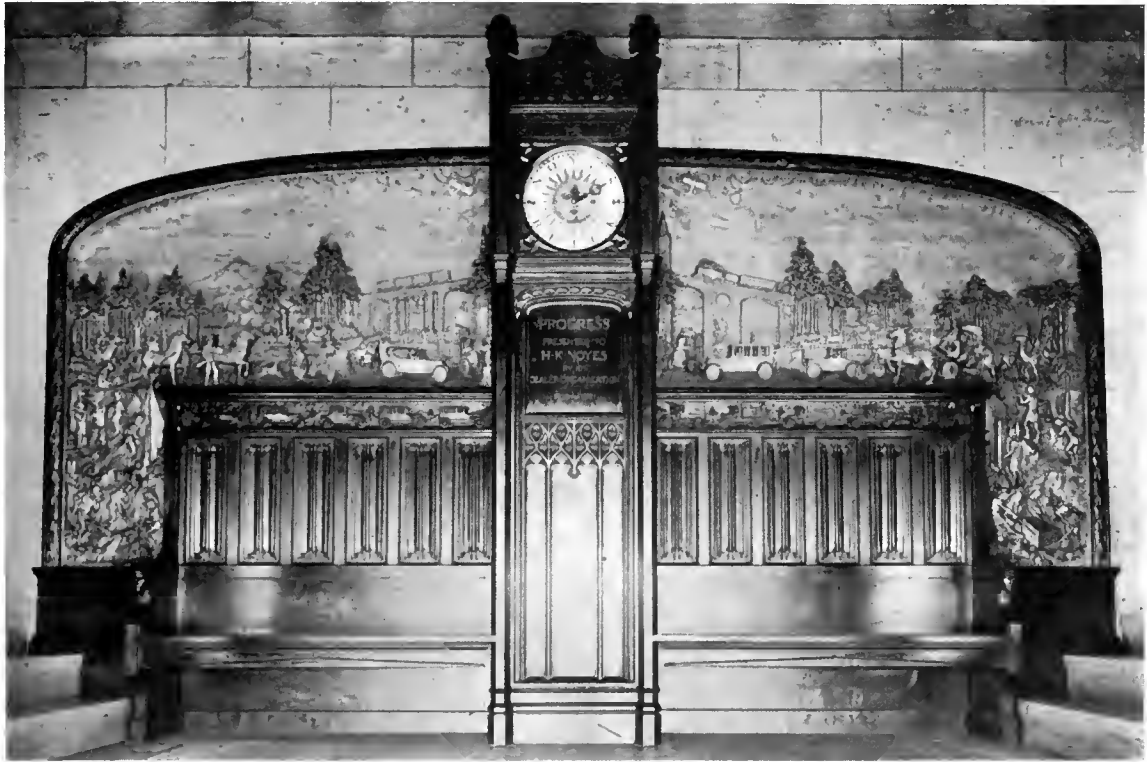

CLOCK IN THE NOYES-BUICK BUILDING, BOSTON, MASS.
THE PANELS PICTURE THE DEVELOPMENT OF TRANSPORTATION. THE CARVING IS IN ENGLISH LIME WOOD, AND WAS EXECUTED BY IRVING & CASSAN—A. H. DAVENPORT COMPANY

The Noyes-Buick Building, Boston, Mass.

ARTHUR H. BOWDITCH, *Architect*

THIS building is situated on Commonwealth Avenue, Boston, in the heart of the automobile district. The basement and first floor cover an area of approximately 50,000 square feet each, and the floors above 25,000 square feet each.

It is absolutely fireproof construction throughout of steel and reinforced concrete, with the exterior finish in Indiana Limestone. In the rear of the building are the tracks of the Boston & Albany—Commonwealth Avenue on the front and streets on either side; this arrangement, giving unobstructed light and ventilation on all sides of the building.

The basement is entered through a large covered court opening on to the rear street giving access not only to the basement itself, but to the two (2)

30-foot automobile elevators that serve all floors of the building. This entire floor is used for the storage of machines, the receiving and delivery of new cars, the transformer room and the heating plant which is a duplicate system, burning oil.

On the first floor, extending for a distance of 200 feet along Commonwealth Avenue are two show rooms, one for cars and one for trucks with the main entrance and passenger elevator centered between them. Directly back of the car show room is a room of 25,000 square feet utilized exclusively for the storage and distribution of parts. This room is completely equipped with steel shelving with receiving and delivery rooms opening directly on the side street—facilities for selling to the public who

THE AMERICAN ARCHITECT

enter the room from independent entrance, and also manager's office, cashier, etc. In the rear of the truck room is the general repair shop. This is an unusual department covering some 30,000 square feet directly serving not only from the outside, but by the two elevators that connect with the receiving court below. It is directly lighted on two sides and is equipped with skylights overhead for at least 50 per cent. of its area. Connected with the main

reached through a large lobby that will be utilized for a general waiting room. In addition to the ordinary arrangement of exterior telephones, all of these offices have an intercommunicating system with each other and with all parts of the building, and from the president's office, the entire organization can be reached and controlled. In addition to these offices, there is a large conference or dealer's room that is utilized for general meetings of the



BASEMENT
NOYES-BUICK BUILDING, BOSTON, MASS.
ARTHUR H. BOWDITCH, ARCHITECT

repair shop is a large machine shop and forge room besides the Superintendent's office, emergency room, chauffeur's waiting room, and locker and toilet room for the mechanics.

THE second floor of the building is used for the offices and clerical work of the company. This floor is reached not only by the central passenger elevator, but also by a large monumental marble staircase from the car show room below. Extending along the entire front of the building are the executive offices of the company. These offices are

different departments, and also can be made the headquarters for the different representatives that come to the building. There is also on this floor a special show room for the individual display of any particular machine or body when it is placed on private exhibition for the dealers before going to the general public. On the rear of this floor, and lighted by northerly light are the general accounting room, order department, stenographers, chief accountant and comptroller. There is also a specially designed fireproof room with steel fittings throughout for general filing apparatus, and the balance of the floor

THE AMERICAN ARCHITECT

is occupied by rest rooms for the men and women in the various departments throughout the building.

The third, fourth and fifth floors are used exclusively for the storage of automobiles and trucks.

The finish of the principal parts of the building is elaborate. The two show rooms are finished in Travertine Stone from floor to ceiling with black marble base and mosaic floor. The ceilings are covered with ornamented and moulded members springing from central circular columns with orna-

taken to establish the depth required and the nature of the foundations, that travelling through the center of the land was an old river bed and the borings showed in some instances that the bottom was from 40 to 50 feet below the street. In order to reach this level, two forms of construction were used to suit the varying condition. One, a concrete pile that could be driven where the condition of the ground permitted and where this proved impractical, owing to the presence of rocks and boulders,



TOP FLOOR
NOYES-BUICK BUILDING, BOSTON, MASS.
ARTHUR H. BOWDITCH, ARCHITECT

mented caps; all of this work in imitation Travertine. The staircases are of Tennessee marble. The rails and the large fireplaces in these rooms are of Indiana limestone.

On the second floor, the main lobby and the president's office are paneled to the ceiling in American Walnut and the various executive offices are finished in mahogany, oak and chestnut.

THE general construction of the building presented many novel and interesting engineering features. It was found, when the borings were

a system of concrete caissons were used. These caissons were circular in form and were gradually lowered to the required depth, the earth and rocks being removed by hand from the interior as they slowly sank by gravity. As all of this work and the conditions surrounding it were unusually expensive, it was most desirable that everything should be done that was possible to lighten the load on these foundations. After a thorough study of all the possibilities, it was finally decided to use a flat slab construction, and in order to decrease the

(Continued on page 219)



HOUSE OF GEORGE D. WHITE, WILMETTE, ILL.



HOUSE OF C. W. STIGER, OAK PARK, ILL.
N. MAX DUNNING, ARCHITECT

The Legal Regulation of Standards of Architectural Practice

By EMERY STANFORD HALL, *Secretary and Treasurer of National Council of Architectural Registration Boards.**

IT may be safely asserted that a majority of the members of the architectural profession stand to-day as a unit in favor of some form of professional regulation. At least a majority believe in the establishing of a minimum educational, experience and character standard as a condition precedent to the use of the professional title of architect. But whether this standardization shall be promulgated and enforced under the police power of the State as a measure of protection of the life, health and safety of the public in the form of a license, or under the power of the state to establish educational measures of fitness in the form of a titular standard, there is much difference of opinion.

The fundamental theory of the license form of police regulation is that protection of the public welfare can best be secured by the State, first assuring itself of the expert knowledge of a certain designated class of its citizens and then depending on that class to act for the public's good.

Titular registration is nothing more nor less than the establishment of an educational standard. It does not say to the public, "You must employ thus and such persons," but it does say to the public that if they elect to employ thus and such persons with the right to bear certain titles they will find these persons reasonably skilled in the fundamental principles of their special line of endeavor.

RECAPITULATION.—License standards are limited legally to mere knowledge of safety. Titular standards have no legal limitation and may be made as high as the profession desires. License regulation prescribes that certain work must be done by a certain class. Titular registration lets any class do the work, but proves how much better and more efficiently work may be done by certain especially well qualified classes. License regulation affords a limited protection to the ignorant portion of the public. Titular registration affords no such pro-

tection. Therefore, titular registration should not be adopted in any State until that State has first provided a comprehensive State building code to safeguard the life, health and property of its citizens—the unwise as well as the wise. Then every reason in favor of the license system of regulation will have been eliminated by providing for the benefits accruing out of this system in another way. With a comprehensive building code, which in the very nature of things will have to be more or less complicated and technical in interpretation, the public will find it necessary to retain competent professional advice in the interests of expedition and economy, and for this purpose the competent architect will be the most practical adviser.

At the St. Louis meeting representatives of the various architectural registration boards, legislative committees of architectural societies in States having no registration laws, members of the board of directors of the American Institute of Architects, and guests, met and compared experiences in the enforcement of registration and license laws, and, in the matter of endeavor to secure legislation, seemed to be, from sentiments expressed from time to time, unanimous in favor of the titular form of architectural regulation in preference to the license form. Yet they took no definite action, due to the fact that they believed that any pronouncement on this subject should come officially from the American Institute of Architects.

Facing the foregoing facts, the St. Louis meeting did the obvious thing—organized the National Council of Architectural Registration Boards, and stated its purpose to be as follows:

"Its object is to foster the enactment of uniform architectural laws, equality of standard in examinations of applicants for State registration or licensure, and the establishment and maintenance of reciprocal registration between States having registration laws."

(National Council of Architectural Registration Boards, 3230 W. Monroe Street, Chicago, Ill.)

*Extracts from paper read before the Illinois Society of Architects, January 18, 1921.

Standardization of Parts in House Construction*

By D. KNICKERBOCKER BOYD, F.A.I.A.

STANDARDIZATION as applied to building construction eliminates duplication of effort and saves valuable time and much money all along the line.

Standardization permits manufacture on a quantity basis and reduces machine costs, both at the factory and at the site of erection thus freeing labor for more essential productivity.

Standardization makes it possible to produce during the slack season thereby tending to prevent seasonal unemployment, decreasing labor turnover and facilitating prompt delivery of materials when needed.

Standardization reduces maintenance costs and makes repair easier.

Standardization makes possible closer cooperation between architects and engineers and the men who produce, distribute and install material and equipment.

Standardization assures a more uniform degree of safety during and after construction.

Standardization increases efficiency and productivity and makes for conservation of our human and natural resources.

I wish to direct attention particularly to standardization of parts in relation to the elevations of American standards of living and American standards of building construction, and also as applied to the increased productivity of American industry. We have already heard about some of these factors, particularly in the lumber industry in which through long established standardized sizes of parts, production proceeds all winter for work which will go on during the most active construction months of the year. Thus the working men in that industry are able to labor all the year round.

The same thing applies in the production of mill-work. In this industry progressive manufacturers have so standardized their product that they can be preparing all winter for the construction season ahead. Thus we also have the materials when we need them.

In the clay working industries a uniform national standard of size for brick has recently been adopted. When brick manufacturers, like the manufacturers of wall and floor tiles, burn their product in what are known as continuous kilns, the process may go

on all winter with great conservation of fuel; and bricks of practically the same size will be available everywhere.

In the slate industry, for which I have been doing standardization work, we have recently so standardized all the slabs and parts which go to make up enclosures, shower baths, stairways and other features for which structural slate is used, that on two small sheets of paper can now be shown the various but comparatively few parts which are required to make up over 130 fixtures of any size or combination likely to be desired. The workmen in that industry who until now have had to go 2 and 3 days a week, sometimes whole weeks, in the winter without employment, will hereafter be employed all winter.

Through standardization in size and thickness of roofing slate, vast quantities may now be produced in advance and stored on the "banks" ready for shipment as required. These are mentioned to show some of the effects of standardization on productivity in the American building materials industry.

When we consider standardization as applied to the structures themselves, we think of it either in connection with the construction of large developments or of individual buildings, and it is the latter that will be briefly referred to without going into the more obvious economies of quantity production. In discussing the individual unit, we must take up the standardization of plan as parts, and the standardization of materials as parts. In considering materials we should draw upon the experience of architects and engineers and of technical experts in all of the industries, and we should cooperate with them and with fire prevention experts and other authorities in determining acceptable standards to be followed with respect to each material. We should take advantage of every economy that we can while making the most appropriate use of every known good building material.

In doing this we, fortunately, can call upon some of the great organizations in this country, such as the National Fire Protection Association, The American Society for Testing Materials, The Underwriters Laboratories, the National Board of Fire Underwriters, The National Safety Council, and the U. S. Bureau of Standards. The U. S. Bureau of Standards in performing a wonderful investigational service all the time. It is collaborating with all the

*Extract from an address before the recent National Housing Conference in Bridgeport.

THE AMERICAN ARCHITECT

others in research work that cannot fail to be of the greatest help. It has, however, limitations, chiefly financial, through lack of appreciative understanding of the great value of its work. Other fine organizations have important work under way. One is the Society of Illuminating Engineers, another is the Bureau of Research of the American Society of Heating and Ventilating Engineers at the Bureau of Mines at Pittsburgh. They are jointly conducting investigations on thermal conductivity, on insulation, on condensation, on air leakage and on almost every other factor which will assist in deciding upon the materials and methods for enclosure of our buildings from the elements.

But in all of the work referred to there is never enough emphasis laid upon the real economic problems of the small house owner.

Now it seems to me regarding this matter that we ought to take into consideration all these facts and assist in co-ordinating and humanizing this work. The National Housing Association itself would have a very distinct function to perform if it could, in doing this, formulate a set of standards for buildings for the working men of this country. Let this association, if it will, appoint a committee on Standards of Construction for small houses for the American people and promulgate a standard section of a building code with respect to these houses, separating them from all other kinds of building construction. Instead of the best technical thought of the country being devoted so exclusively to making good construction better, let more time be devoted to making poor construction good. The worker's house is the place to begin; for, it certainly is in need of consideration throughout this country.

One of the defects in building codes is that in some ways, we have been extravagant in the use of our good building materials, thus promoting poor construction where choice is permissible. Therefore, if we base all materials on safe practice and performance and formulate standards accordingly, we ought to be able to make very effective economies along the line of good construction and yet eliminate sub-standard construction almost everywhere.

We must not, however, allow ourselves to border on an unsafe minimum of structural requirements, an unsafe minimum of thickness of materials to keep out the weather, and an unsafe minimum of protection to the owners of homes against loss of life and property by fire.

Now in regard to standards in plan, arrangement, light, sanitation and other factors affecting the amenities of life; under the guidance of the Secretary of the National Housing Association, a committee of architects, engineers, housing specialists and others

worked out an excellent set of skeleton standards with the Department of Labor for War Housing Construction. Later the U. S. Housing Corporation developed a valuable series of standard specifications and details for the construction of workingmen's homes. That was in the early stages of the war, and later all of these standards were referred to the War Industries Board. This body, with which it was my privilege to serve as chief of the Materials Information Section of the U. S. Housing Corporation, took up the standardization of one factor and one material after another and issued various standards as Government war measure.

It was still engaged on that work when the Armistice was signed; but in spite of that fact it completed some of its unfinished standards, which some day will become available in a publication for very limited distribution. Among these are standard specifications and details for carpentry and millwork, lighting fixtures, hardware and other material. They were used in ordering materials required by the Government in its housing and war construction. With these in the hands of the industries of the country we could order by telegraph anywhere and get exactly what we wanted. It was a very simple procedure.

My idea is that the National Housing Association might take up these standards and, through the new committee proposed, promulgate them and formulate the other standards which I have suggested. This should be undertaken as a separate small house problem distinct from all usual building construction as embodied in the building codes of our cities, and in new codes which are being prepared by many of our states. The National Housing Association should, it seems to me, do these things; namely, work on standardization of parts, and on the development of types for workingmen's houses and should father a movement to co-ordinate all investigational activities affecting the construction of small houses, to insure permanency, lessen the cost of upkeep and make for the safety, health and comfort of all occupants.

Let us take the lead in reducing upkeep, insurance and other preventable charges. If we can stop the everlasting annual drain on the occupant's pocket book caused by improper construction of his building in the beginning, we will in the end bring about a real elevation of American standards of living.

By improving the standards of building construction in general, and through standardization of parts helping to make for greater productivity in American industry, we will enable the workingmen of the country to have contentment and better health, to put in more hours and get more money.

Color in Architecture*

ONLY of late years has it been conceded that the duty of architects is to give the best possible combination of form and color, and that the completest form of architecture is that which affords examples of such a combination. For the last three centuries architects have shown an increasing disregard of, and almost a contempt for, color to such a degree that people till recently were taught to believe that purity of style and absence of color always went together, and that it was only a vulgar and uneducated eye which saw the greatest evidence of good design and matured thought in the harmonious combination of color and form. Sculptors encouraged this feeling by deprecating the application of color to their work even when it was purely architectural. Both architects and sculptors found it convenient, apparently, to disencumber themselves of one-half of the responsibilities of their calling, and so escaped all obligation of studying the laws of color. Painters ceased to regard wall-painting as their legitimate work, and have completely sunk into the habit of treating only small subjects in a small way.

Those who argue against the application of color to architecture do so without the authority their ancestors would have given them. Though there has been much difference of opinion as to the extent to which color was applied by the Egyptians, the Greeks, and the Romans, there has been none as to the fact that some introduction of color was well-nigh invariable in their work. Owen Jones' "Apology for the Coloring of the Greek Court" at the Crystal Palace contains in a small compass sufficient evidence to show how strong is the ground of those who maintain the necessity of color in classic buildings; the report drawn up by the Committee of the Institute of British Architects on the coloring of the Elgin marbles, with Professor Faraday's analysis of portions of the coatings of marbles brought from several ancient buildings in Athens, all make it perfectly clear that color was extensively and generally applied. Professor Semper of Berlin proves that the Syrians, Persians, Egyptians, Chinese, Indians, Jews, Phœnicians, and Greeks employed color in their architecture and sculpture. There is no country which has been in any way remarkable for its architectural monuments in which the necessity of the combination has been ignored or forgotten.

Color was used in all the early buildings of

nearly all the races of mankind with some plan or system depending on the actual knowledge or inherited symbolism possessed by the priests and craftsmen who planned and made the temples and palaces. Sometimes the use of color was based on the esoteric mysteries of the time, and skilfully utilized in the ceremonial magic of the temple rites, or again blazoned with deep significance on walls and on the figures of the gods themselves. There is consequently much of interest in the study of the ancient employment of color, even if we do not always fully appreciate the real meaning of the colors, or if, on the other hand, we attribute knowledge of color where there was in reality no more real understanding than many modern users of color possess.

In Egypt the introduction of colors bright and brilliant was everywhere, at almost all times, alike for general and religious use. In the temples, in which the understanding of color by any race will be shown if it is shown anywhere at all, the Egyptian artificer covered all manner of surfaces with pigments. The palaces of Babylon and of Chaldea were literally dependent for their beauty on applied color, whether of metal or textile, enamel or pigment painted on a plaster surface. It is doubtful whether the art of color decoration began in Egypt or in Babylonia, but certainly there is no question as to where we find the greatest merit. Egypt has the most wonderful color in the world, the understanding of which came from a high culture allied with a magnificent conception of religion and of the universe. This is marked even in the earliest dynasties of which we have any knowledge, and the decadence of their art follows a slow decline in this respect from any other phase of art in the world. The one essential and intransient difference between Egyptian and Greek art was that the pantheism of the Egyptians, being highly esoteric and taught by symbolism to the masses, was largely rendered by means of a mixed animal and human pictograph, whereas the Greek rendering of their understanding of the same truth was rendered solely by human types idealized to the summit of their power. All these nations used color as the most powerful aid their art could obtain, no thought of naturalism or realism such as is current today ever entering their heads. They were masters of their art, not victims of technique.

Egyptian architecture was developed under the stress of a great building epoch, just as later the mediæval churches were built in such a high-strung period, and in our own day American architecture, in which we can see the architecture of the

*From a lecture delivered at the Caxton Hall, Westminster, under the auspices of the International College of Chromatics, by Mr. W. G. Raffé, A.R.C.A. (London), F.R.S.A. (Art Director of the Northern Polytechnic Institute, London).

THE AMERICAN ARCHITECT

future already forming, is being produced under such another period of activity.

There were two great and distinct orders of architectural colorists—the constructional and decorative. The first are those who built their walls partially or altogether with colored materials, the second, those who so built them that color might afterwards be added, and with a special view to its introduction. The work of the constructional school is divided into classes: (1) Those in which the colored materials were part of the substance of the walls and necessary for the stability of the whole fabric; and (2) those in which the walls were covered with decoration, such as mosaic, or tiles or thin veneers of marble, which had nothing whatever to do with their structural requirements. The first class was that which was, on the whole, both the best and the most frequently adopted. The few examples which we see in this country, and, indeed, generally throughout the north of Europe, belong to it. The poverty of England in colored stones or marbles will account sufficiently for the comparative rarity of the examples we can adduce. Among them are many of the Northamptonshire churches, which are built with horizontal bands or courses of dark-red and light stones used alternately, in other districts we find courses of stone and flint alternately. In others flint and stone are used, but with inferior effect, in regular chequer-work over the whole surface of the wall. Our red-brick buildings are constantly diapered with patterns in black. The interior of our churches, when not painted, were usually left with the natural color of all the stone work—whether wrought or not—visible on the interior, an arrangement which, though rough and rugged in character, certainly gives a great amount of natural color in a low key, but infinitely more agreeable to the eye than the cold expanse of plaster generally visible in new public buildings. Finally, throughout the thirteenth century the introduction of polished marble columns, of a color much darker than that of the materials of the walls, is one of the most marked features in all the best English work. Every one of these arrangements is noticeable as having been introduced intentionally and with a sole view to variety of color.

Decorative painting was almost universally adopted at the same time. In this application of color all countries agree, and there is hardly room to doubt the beauty and expediency of the practice.

In discussing the all-important question of the materials to be used, there are two principal means of decoration which can be achieved by utilizing our materials. One is the method of equalizing the tones and the distribution of color so carefully that the whole building, whether exterior or interior, is

full of color rather than of colors; that they are so adjusted that none can assert itself beyond any other. This kind of decoration is desirable in all places where no particular function of state or worship and so forth are to be exercised. In a ball-room it is not desirable to emphasize any part of the room chromatically above any other part, except as regards the importance of the various features as architectural members. The other type of chromatic arrangement is the principle often found in a close approach to any natural object, and one which was largely favored by the Greeks. It is the principle of subordination of the many to the few parts or places. The Romans often fell over themselves in trying to combine these two principles. They wanted to emphasize the majesty of the emperor and at the same time desired an unsurpassable magnificence in their surroundings from floor to roof. In despair they commenced to emphasize form in the proportion and features of buildings and color only in relatively minor accessories, often the movable furniture of palaces. Unable to handle successfully architectural polychromy, like so many moderns, they took refuge in whiteness.

There seems to be a curious analogy in the ascending scale of architectural color. The lowest are those of the earth, the natural colors of the common building materials. When water is brought to the aid of the colorist, he selects from these and obtains more vivid and pure color. When later he takes them to the test of fire, color becomes more subtle, translucent, and mysterious, while the air has always been regarded by artists as an improving hand at work on the crudities of man, blending and softening. To venture a prophecy, it is likely that the color of architecture in future will be artificially obtained by fire, even as the colors of the most beautiful marble were obtained by fire, even as the colors of the most beautiful marble were obtained by the natural fires in bygone ages. The finest color that we have in architecture of an artistic character, apart from the natural colors, are those in mosaics, stained glass, and colored terra cotta, all of which are subjected to fire and have thus attained more permanence.

The discoveries of Schliemann at Hissarlik showed that among other remarkable methods of ancient building was the practice of vitrifying the walls after erection. And he put forward the idea that the walls had been built of unburned clay and then vitrified by the subsequent lighting of huge fires on both sides at once. The interest for us lies in the transformation of a singularly perishable material into an almost imperishable one. We have today newer and different modes of obtaining great local heat without resorting to such daring methods as lighting huge fires not under our control. If we

THE AMERICAN ARCHITECT

can weld a ship or an aeroplane together with intense local heat, why cannot we weld the exterior of a building together, and thus produce at once a magnificent ornamentation and a practically imperishable structure? There seems no reason why iron and glass should not be used structurally together, to the exclusion of all other material. Glass has not hitherto been used structurally, why should not scientific research again reveal the secret of malleable glass which the ancients possessed, and so to give us a larger coefficient of expansion to suit with the iron and steel the varying temperatures of climate. Enamel can be persuaded to remain on iron plates for advertising; there is no reason it should not be used for architecture, either on iron or the more traditional brick. Electric and acetylene welding have reached such a pitch of perfection

that temperatures beyond imagination can be reached, under which not only glass, but the bricks themselves would run like water. It is possible now to bind the joints together with a vitreous cement instead of one made of lime, and if the bricks are individually enameled the entire surface can be made of shining glass. Even over concrete, if suitably mixed and well cured, some such process as this should be possible. Color over another material would be almost necessarily opaque, but again if a tempered glass were used in place of concrete and in a similar mode of construction, over a webbing of finely reticulated steel, a translucent effect could be got that would make the city built of such structures a veritable wonder of color in glowing form at night.



MODERN COMMERCE
DECORATION FOR COMMERCIAL HIGH SCHOOL, BROOKLYN, N. Y.



Organized Labor Enters the Field of General Contracting

ORGANIZED labor has entered the field of general contracting in Boston. The Building Trades Unions' Construction and Housing Council was recently equipped with a charter, has undertaken and completed several jobs, and is going ahead on more of them.

The Council is incorporated and assumes the legal responsibilities of a corporation. Since unions generally are not incorporated, no paid union official can hold office in the council, which is made up of the men in the construction industry who earn their living with their hands and tools.

The corporation is capitalized at 100,000, divided into shares of \$10 each. No shareholder can buy more than ten shares. There are nearly 1,000 subscribers already. More money can be raised easily, the leaders say, because there are 42,000 union men in the building trades whose thirty-three locals are represented in the Council. Besides these, there are 50,000 other union men affiliated with labor organizations in greater Boston.

A co-operative bank, the leaders say, will be organized. This institution will finance the building of homes for members or outsiders. Since a state bank may lend about 80 per cent. of the value of real estate, and the co-operative scheme of building makes it possible to build much cheaper than under the old methods, this 80 per cent. loan will go quite a ways toward covering the total cost of the job. The bank takes the first mortgage. The owner puts money into the house. The Council will then take a second mortgage for the difference between the cost and the loan obtained from the bank. This is plus the owner's cash on hand. This will ease financing to such an extent that a stimulation of the building of homes among workmen is confidently expected.

MATERIALS will be bought on the co-operative basis. The brick yard, gravel pit, lumber yards, and all other sources of materials which can be successfully financed by the Council will be run co-operatively.

Since no paid union officials are connected in any way with the Council, there will be no possibility of a strike on the job, nor any lockout. Injunction

proceedings brought against a labor union, or unions, will not involve the Council's workmen.

A prospective job is handled rather simply and quite logically. The Council discusses the job, and at this discussion there is a mason, a carpenter, a bricklayer, a plumber and the other laborers and craftsmen of the building trades. There is also an architect present. He works for the Council. Each craftsman is asked to estimate his part of the work, this is summed up, passed upon by a final authority, and a bid submitted. If the Council gets the job, one of the members takes general charge of the work until it is finished. During the work, the general foreman is in constant touch with the owner, and any changes he may desire to make are permitted.

The first house was undertaken and built before the Council had actually been wholly or effectively organized, yet that house was finished in about three weeks, and at a cost decidedly below what the owner would have had to pay otherwise.

This achievement on the part of organized labor in Boston is a most encouraging sign of what the word co-operation really means when it is put to actual practice. There has been a great deal of talk recently regarding co-operation—conferences, conventions—but here is a group of men who have actually put the word to work, and who are building houses and are steadily putting up more of them, at costs lower than could otherwise be achieved.

THE interesting part of it, of course, is that the movement is entirely backed, and promoted, and managed by working men. Few, if any of them, were so much as familiar with accounting, finance, and the great mass of office routine which is necessary in the administration of such an organization. A number of the leaders associated with the movement are going to the Trade Union College in Boston, where they are taking courses in the various matters which enter into the administration of the Council. They have received help, and are receiving it, from Harvard University and from Boston lawyers. They gratefully acknowledge the generous help accorded them by these lawyers at the beginning of the Council's life. Members of the Council are also taking courses in banking, architecture, and accounting at the Trade Union College.

St. Andrew's Church, Staten Island

(See Reproduction of Original Drawing by O. E. Eggers on Opposite Page)

THE sketch shown, done by Mr. Eggers, represents a structure in its two hundred and fourteenth year of existence. In 1908, upon the completion of its two-hundredth anniversary, a tablet was placed upon its wall to commemorate the fact that it has held its own since the days when Queen Anne gave it the royal charter under which it was established.

Romance has surrounded this quaint parish since long before Revolutionary days and it has done its share in making the history of the East. Today St. Andrew's is one of the show places of Staten Island. It is a modest structure of old gray stone and lies off the beaten path. Yet visitors are possessed with a feeling of awe as they look upon the dimmed legends of stones that have marked graves for two centuries and picture to themselves the fierce fight between the Americans and British when this church gave protection to each army in turn.

From its quiet graveyard one may look across the swampy fields almost to Fresh Kills, from which the American soldiers advanced when they charged against the British and made them seek shelter inside St. Andrew's.

In October, 1776, so the story goes, the Americans under Gen. Hugh Mercer crossed from Perth Amboy, New Jersey, to attack the British troops, stationed in Richmond, and pursued them to the church to which they retreated. The Americans stormed the building, shooting until every window pane was shattered and then threw stones to conserve ammunition. At this, a soldier came to the door and stated that the troops within were ready to surrender, offering the explanation that the church was being used as a British hospital, and that wounded and suffering men lay within.

During the Revolution, when the British were in possession of the island, services were suspended in all its churches except this. St. Andrew's was twice partly destroyed by fire, but portions have withstood the ravages of two centuries. In the Metropolitan Museum, New York, there is treasured a silver communion service which Queen Anne gave the church when the charter was granted.

2061-



ST. ANDREW'S CHURCH, STATEN ISLAND, N. Y.
THE AMERICAN ARCHITECT Series of Early American Architecture

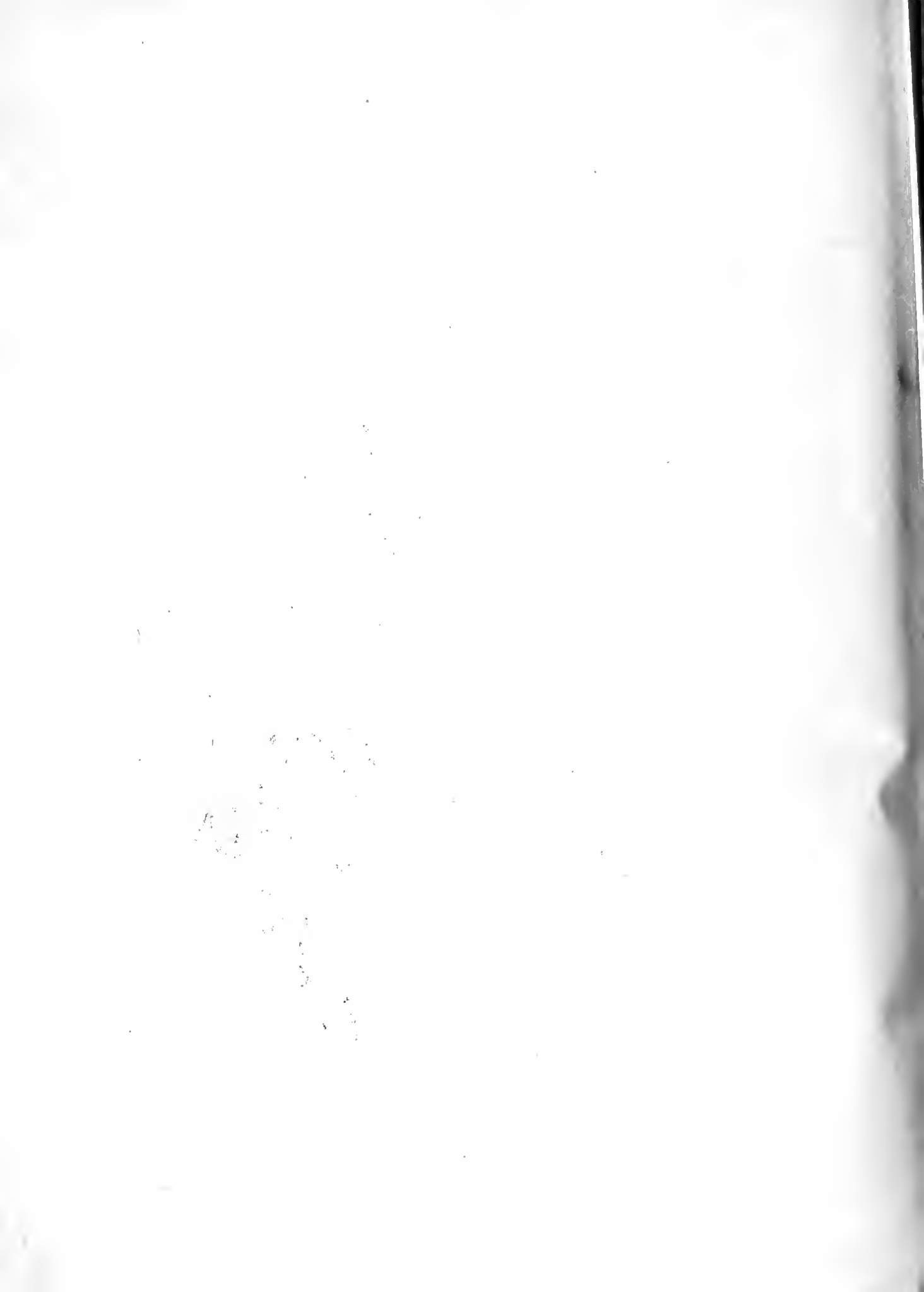

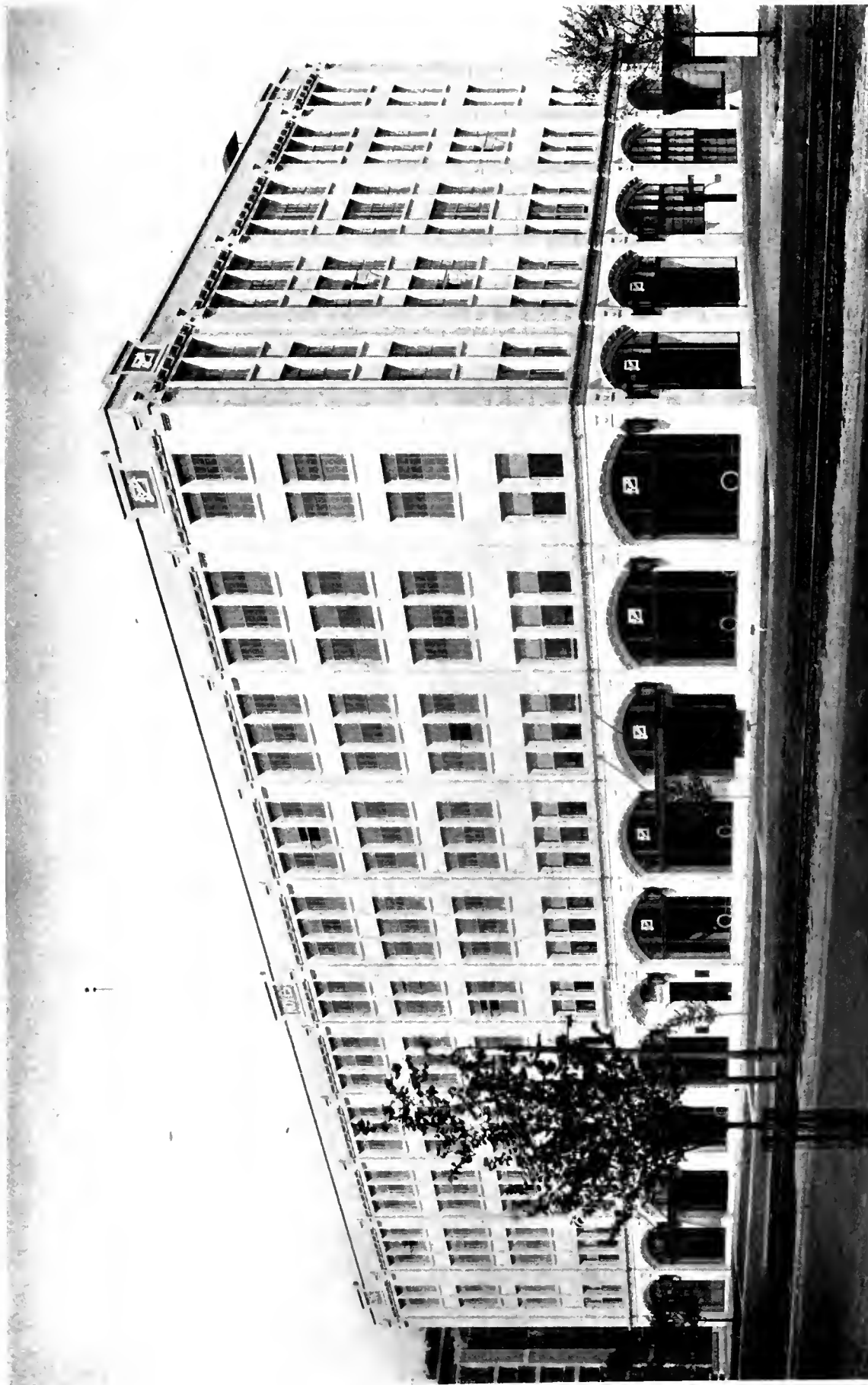

NOYES-BUICK BUILDING, BOSTON, MASS.
ARTHUR H. BOWDITCH, ARCHITECT

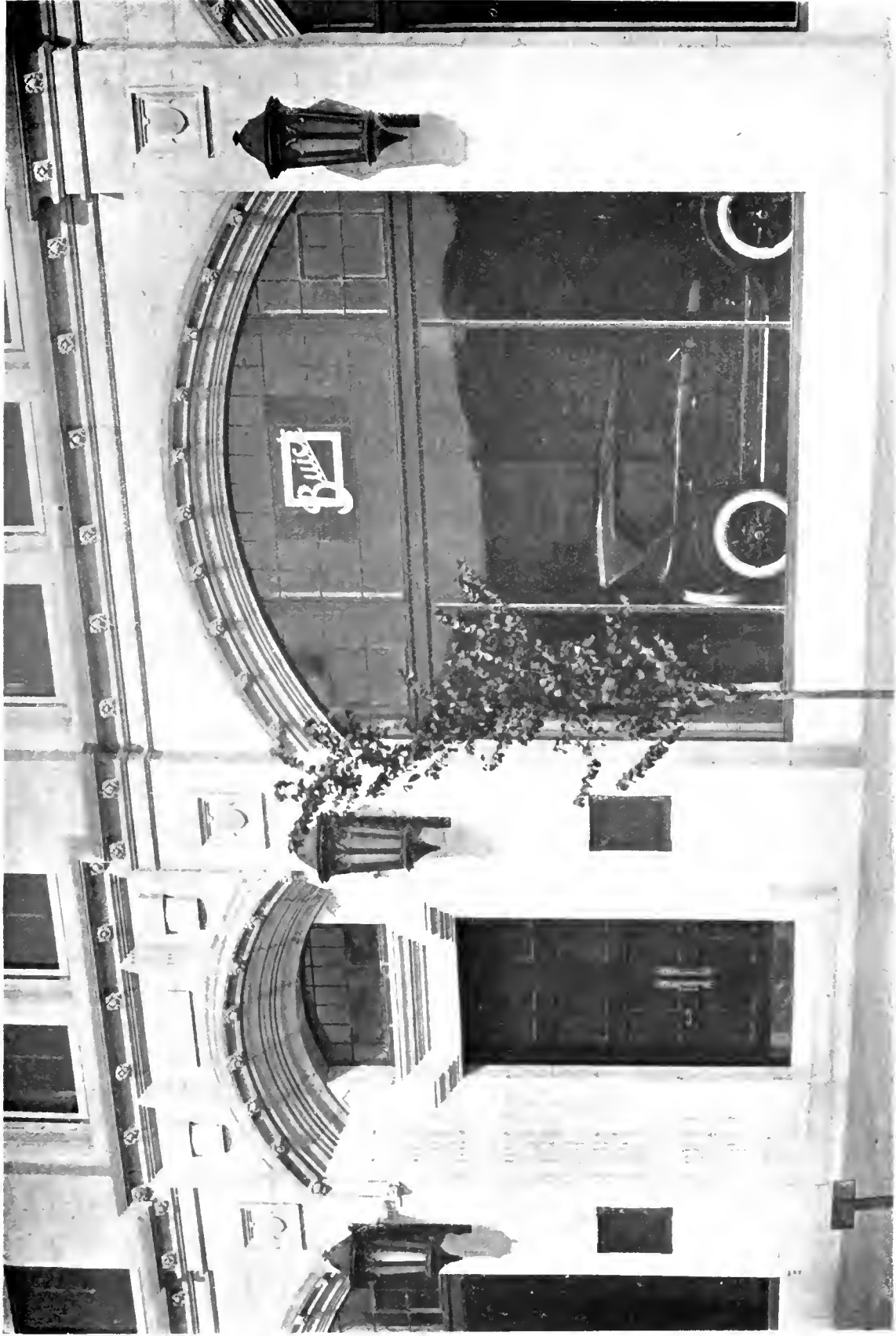

EXTERIOR DETAIL.
NOYES-BUICK BUILDING, BOSTON, MASS.
ARTHUR H. BOWDITCH ARCHITECT

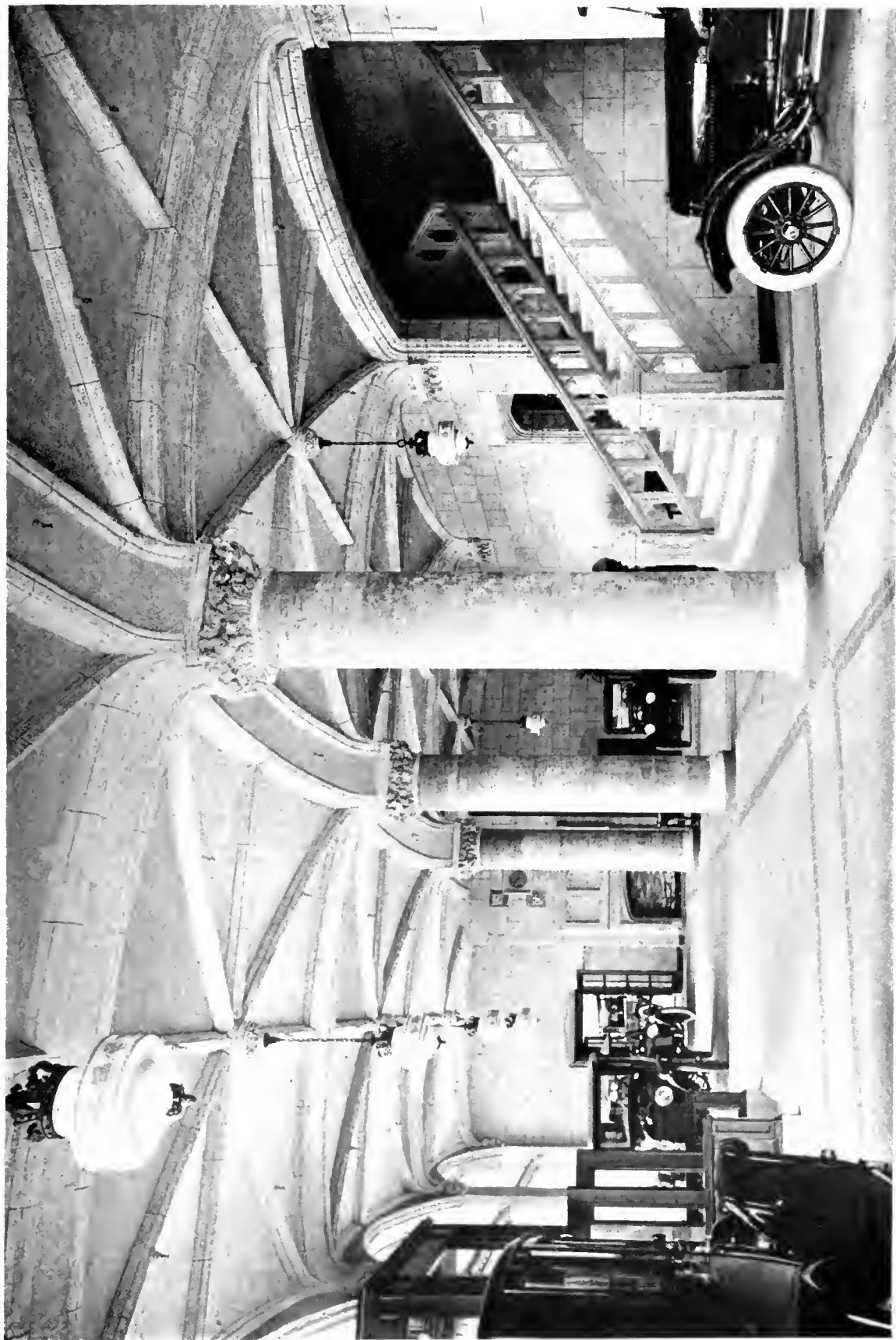

VIEW IN SALESROOM
NOYES-BUICK BUILDING, BOSTON, MASS.
ARTHUR H. BOWDITCH, ARCHITECT



STORE AND OFFICE BUILDING, BOSTON, MASS.
ARTHUR H. BOWDITCH, ARCHITECT





SIBLER HOUSE



ENTRANCE
KENOSHA CEMETERY ASSOCIATION, KENOSHA, WIS.
N. MAX DUNNING, ARCHITECT

DEPARTMENT OF ARCHITECTURAL ENGINEERING

The Noyes-Buick Building

Gow Piers and Cellular Flat Slab Floors Selected as Best and Most Economical Design

By HENRY F. BRYANT, *Engineer*

THE Noyes-Buick building on Commonwealth Avenue, Boston, is a reinforced concrete, five-story structure, with stone exterior trim and non-burnable interior finish. This building presents two unusual structural features of special interest, namely, the foundations and the floor designs.

The area covered by the structure was originally a tidal peat bog bordering on the Charles River and having irregular depths of from 2 to 45 ft. The street front had been filled to nearly 20 ft. above the surface of the bog and the earth slopes, both above and below the bog, had encroached on the land about 30 ft.

This condition required the use of several types of foundations for the 120 columns which carry the building. Foundation loads per column range from 100 to 500 tons per sq. ft. unit load on the underlying sand and gravel. A portion of the front

columns on coarse gravel was permitted a load of 6 tons per sq. ft. Column loadings were materially reduced by adopting a cellular type of flat slab floors which reduced the dead load below that of the usual solid flat slab by about 15 per cent. This was an important factor in the economical design of the foundations.



THE NOYES-BUICK BUILDING, BOSTON, MASS.

The majority of the foundation piers were of the type largely introduced and executed by Lt.-Col. Charles R. Gow and generally known as Gow piers. They were put down in open excavation by using telescoping steel cylinders about 60 in. long, differing 2 in. in diameter. These were pushed or hammered down along with the hand excavation. Near the bottom, in peat or other favorable soil, the last two feet was chambered out to the full size of footing and the entire tube filled with concrete, the cylinders being withdrawn during filling. The re-

sult is a cylindrical pier on a concrete bell, the former tapering from minimum size at the bottom to a diameter about 12 in. larger at the top of a 30 ft. pier.

For economical reasons, it was decided to use 16 in. concrete cast-in-place piles for the three front column rows and these were put down by the New England Foundation Company in the form of Simplex piles. The piles were figured to carry 25 to 30 tons each. In order to carry that load, they were driven from 12 to 15 ft. into the sand and gravel bearing soil on the principle that one square foot of friction surface will safely support 1,000 lbs. The Mannesman steel tube forty feet long was too short for many of the piles and required removable extensions in order to meet the requirements.

Driving was done with a 3600 lb. hammer, giving a total penetration of from 1 to 3 in. for the last eight blows under a constant drop of 10 ft. Pile No. 11, having a penetration of 1½ in. for the last eight blows and driven approximately 10 ft. into bottom, was tested. This test showed a per-

manent settlement of 0.03 ft. under a three-day application of 55 tons. A load of 60 tons increased the settlement to a permanent set of 0.053 ft. As a factor of safety of 2 was sought, the test was satisfactory and appeared to be in accord with the principle previously mentioned.

In attempting to drive the steel casing for the piles under the street piers, great difficulty was found in getting them down through the gravel fill and shallow compressed peat remaining underneath.

It became impossible to penetrate into bearing soil to any depth regardless of ruined tubes and apparatus and recourse was again had to open-top caissons. These were made of concrete 8 in. thick cast in place and sunk by gravity or by jacking down. These

caissons were eight feet or more in diameter and were chambered out but very little at the bottom because of the shallow depth of peat. They were generally of sufficient carrying capacity to permit filling with earth instead of concrete, and were floored over at basement level to secure a platform on which to start the concrete columns.

Examination of the foundation plan will show that under small portions of the external walls and boiler room continuous longitudinal footings at shallow depths were used. In doing this, considerable care was exercised in making the transition from one type of construction to the next. To carry the basement floor loads, a dug pier or concrete pile was placed in the center of each bay since the underlying earth proved too soft to be of use.

In this unusual combination of deep and shallow foundations the results obtained show the usual economy of using lower priced soft land at the expense of additional construction costs which, if properly handled, should be much less than the discount ordinarily received on the land because of its foundation difficulties.

The building covers about 52,000 sq. ft. of ground area. The front section consists of five stories and basement with an area of 25,000 sq. ft. per floor.

Except where the outside ramp with its heavy loads is carried by beams and girders as at C, or a one-way ribbed section suspended from overhead trusses as at B, the entire first floor is a cellular flat slab design.

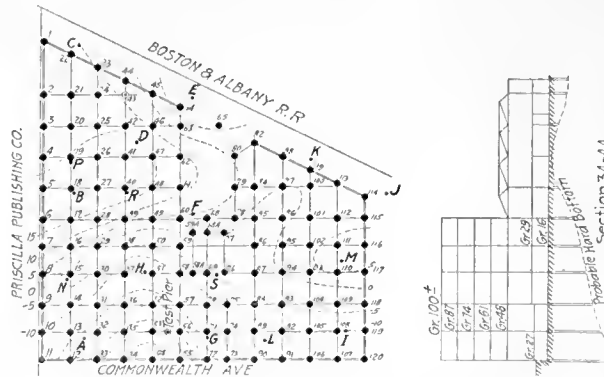

CONTOUR MAP OF PROPERTY

NOTES: Foundation Piers Proportioned for max Stress in Shear 500 lbs. sq. ft.
Max. Load on Soil 5 Tons p.a. 5 Concrete Piers max cap. 30 Tons each.

- Wood Piles Concrete Ext
- ⊗ 16" Concrete Pier 12' Footings 36" Diam
- ⊙ 16" Concrete Piles

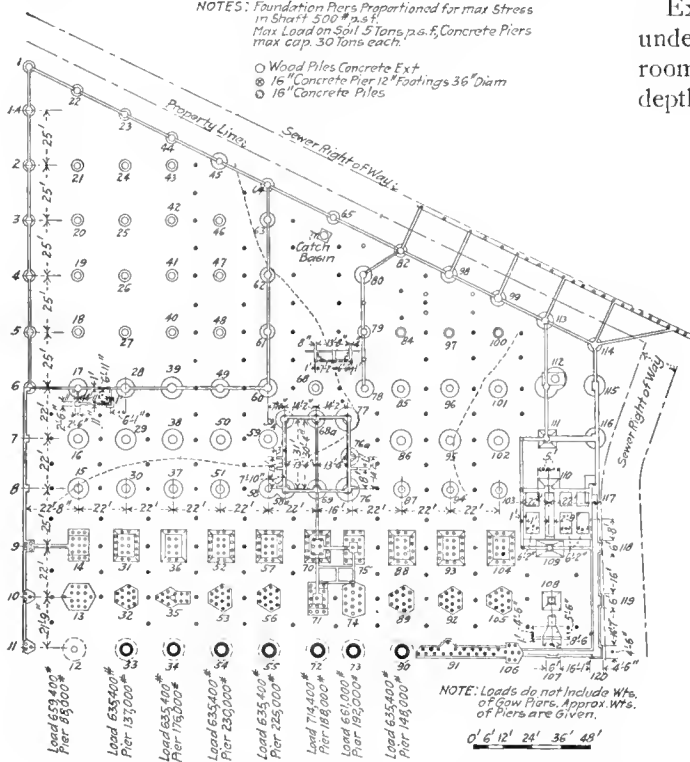

FOUNDATION LAYOUT

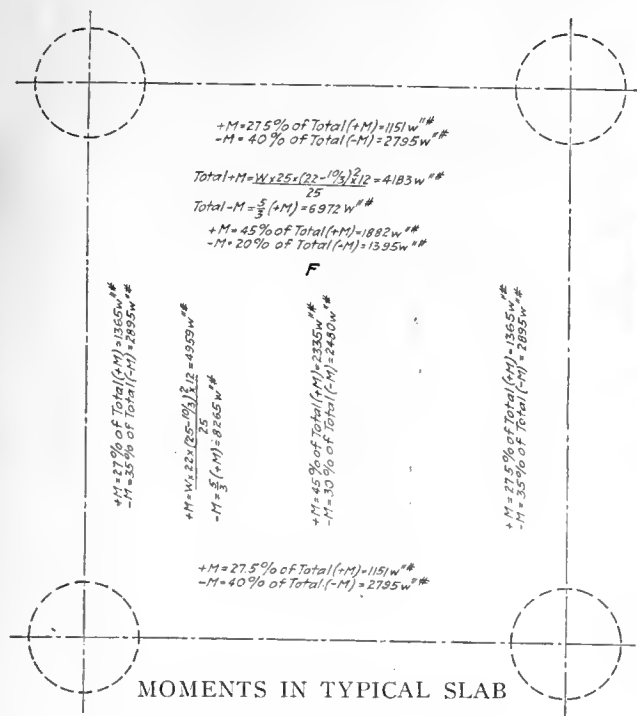

STRUCTURAL FRAME COMPLETED

in. square and 8 in. high placed on 26 1/4 in. centers both ways. When forms were withdrawn, beams 5 3/4 in. wide and running both ways were left, giving a checkerboard or waffle-like appearance to the ceiling.

Reinforcement, as shown in the accompanying drawing of typical floor slabs, consisted of rods in the bottom of the beams in both directions, bent up over supports and supplemented by extra bars in the column heads.

One of the drawings gives the moments as figured for a typical interior bay under the provisions of the Boston law. Under this building law, the strength requirements were for 150 lbs. per sq. ft. less a reduction of 25 per cent. for slabs exceeding 300 sq. ft. or a net live load of 112 1/2 lbs. per sq. ft. The law permits a depth of fire protection below the steel of 3/4 in. in the solid slab and 1 1/2 in. in the ribs. This gives a value of *d* as 7.88 in. in computing values.

Steel dome forms were purchased from The Tru-

The roof of the two-story rear section is entirely a one-way ribbed type which, under actual roof load conditions, shows an economy over flat slab.

Each floor of the multiple story section, as well as the roof, was cellular flat slab construction with the exception of the ceiling of show room and office vestibule. In these cases flaring column heads were eliminated for architectural reasons.

A typical interior panel was 22 ft. square with a 5-ft. capital and a column head 9 ft. 4 in. square. The floor thickness was 10 in. without drop panels, and including 2 in. over the tops of the cells. In the work shop, an additional thickness of one inch was used, making 11 in. in all. This extra thickness was intended as insurance against puncture by heavy blows, or from similar unusual conditions.

The cellular slabs were obtained by the use of steel dome forms 20 1/2

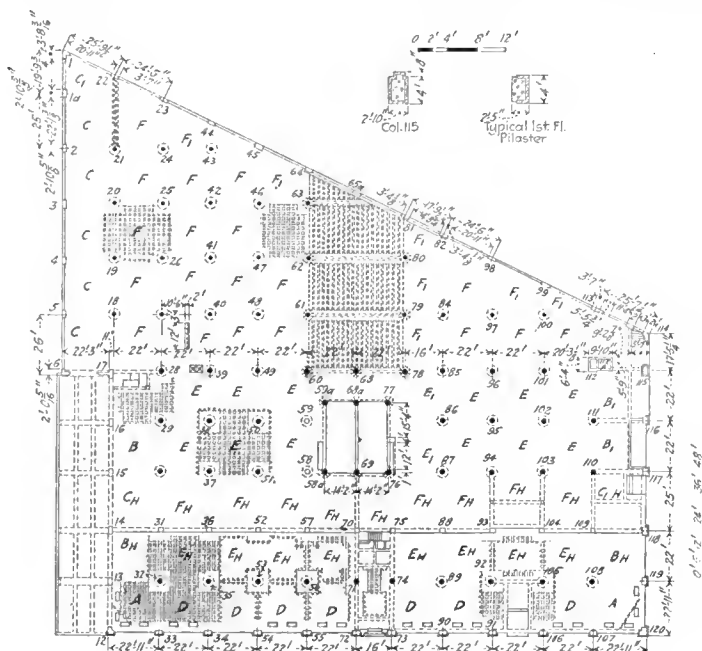

FLOOR PLAN

con Steel Company, Youngstown, Ohio, under a guarantee against patent infringements. They are made of No. 16 gauge metal, hot pressed to shape and sheared to give a one inch marginal flange. Although they were used from 5 to 10 times each on completion they were substantially as good as when new and were ready for resale.

As required by the code the weight of a 9 1/2-in. solid floor would have been 115 lbs. per sq. ft.,

THE AMERICAN ARCHITECT



FLOOR FORMS UNDER CONSTRUCTION

whereas the weight of this cellular type was used in the computations as 20 lbs., or over 30 per cent. less.

ON THE RIGHT
PLACING THE DOMES ON
THE FORMS



ON THE LEFT
FORMS IN PLACE READY TO
RECEIVE DOMES

On the columns and footings the figured load was over 15 per cent. less. The steel saving was directly proportional to the total floor loads or about 15 per cent. and the concrete saving was the same as the saving in weight.

Naturally the adoption of this design depended on the cost of the forms as compared with those for ordinary slabs. The savings in concrete and steel ran into large figures and, if the form costs were not much greater, the plan must be used. Considerable study was, therefore, given to details of the form work with the results shown on the accompanying cuts.

To permit of rapid removal and re-use of the domes, it was arranged to withdraw them within 30 hours after they were poured, leaving the posts and stringers under the beams for the usual time. Joists, 4 in. x 4 in., planed on top with 2 in. x $\frac{7}{8}$ in.

section with possible excessive shear at the plinth. Both these matters can be met by using tapered dome forms, but they were not required in this case.

(Continued on page 214)



LOOKING UP AT UNDER SIDE OF SLAB
Forms have been removed

Creosoted Wood-Block Factory Floors

Paper Presented at the Annual Meeting of the American Society of Mechanical Engineers

EY LAMBERT T. ERICSON*

THE use of creosoted wood blocks for factory floors has been so extensive during the past few years that it is hardly necessary to go into details in regard to the advantages of this type of flooring. The splendid way in which this material withstood the extreme service to which it was subjected in countless munition and shell plants during the war helped to elevate it to its true rank. Most engineers and architects have come in contact with this material at first hand, so that this paper will be confined to a discussion of:

- (a) The material used
- (b) The problems encountered
- (c) The field covered.

Wood floors have many advantages over all other kinds—they are comfortable under foot, resilient and do not radiate heat or conduct cold. Wood in the form of planks or matched flooring is not, however, adaptable for heavy shop purposes as it disintegrates under heavy traffic and the abuse incidental to shop practice. It is also unsanitary and adds to the fire risk after disintegration commences. Creosoted wood blocks, on the other hand, if properly installed, have all of the advantages cited above, without the disadvantages, as they are practically wear-proof and are very fire-resistant when placed upon concrete.

Southern yellow pine has been used almost entirely for this work, except on the West Coast, where Douglas fir and tamarack is used. Long-leaf pine is usually specified, but short-leaf pine is also adaptable for the work. The lumber should be thoroughly air-seasoned before being cut into blocks, and then should be given a preservative treatment with coal-tar creosote oil to preserve the wood from decay. Hard woods, such as gum, beech, and maple, can

be used, but they are not favored on account of the difficulty in properly seasoning the lumber and the tendency for the blocks to warp and check after they are cut. The coniferous woods are more homogeneous in grain and texture and are consequently more adaptable. Soft wood compacts under service and consequently it is just as serviceable as hard wood, and has the advantage of not becoming slippery under traffic.

Creosoted wood-block factory flooring is a logical development from street paving, but in this development a great many mistakes have been made due to misunderstanding of the problems involved. As a general rule the problems are just the reverse of

those in street paving. A great many failures in creosoted wood-block flooring in the past have been due entirely to improper methods of treatment and installation of the blocks. Occasional failures still occur, due to lack of understanding, by those in charge of the work, of the problems involved.

It should be understood in the beginning that factory flooring with creosoted wood blocks cannot be grouped under one general heading and specification. The conditions under which the floor is to be used must first be studied and the specifications made to suit. Creosoted wood blocks can be laid to meet practically all factory conditions if the conditions are first properly analyzed. The real reason for the most of the trouble encountered with this type of flooring is the fact that wood expands and contracts with various conditions of the atmosphere and the moisture content of the blocks. It is therefore necessary to lay the individual blocks in such a way as to allow for this change in volume, which in extreme cases may be as much as 5 per cent. The individual units in the floor must be bound tightly

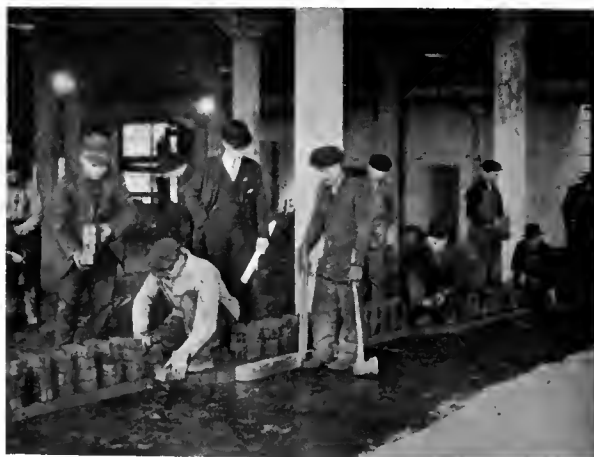

LAYING A WOOD BLOCK FLOOR

*Chief Engineer, The Jennison-Wright Company.

in place with a binder which will allow this expansion and contraction and which will exclude water from the underside of the floor. As long as the blocks are held tightly and firmly in place and a smooth surface is maintained the floor will wear almost indefinitely, but as soon as the blocks become loose and the surface becomes rough they will break up into sticks very quickly.

The three most essential requisites for success are:

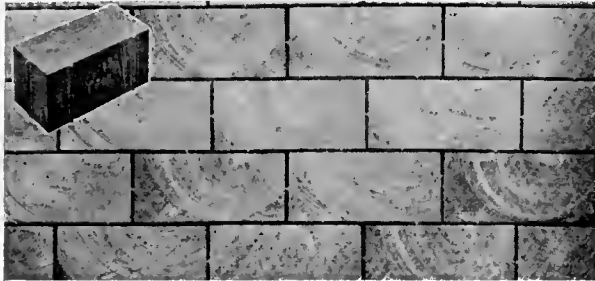

WOOD BLOCKS WITH LUGS

- (a) Thoroughly air-seasoned lumber
- (b) A smooth, solid foundation base
- (c) A waterproof and elastic binder to hold the units in place.

In the majority of cases factory floors are dry most of the time; consequently, the lumber should be thoroughly seasoned, in order to keep the shrinkage to the minimum. Blocks cut from green or semi-dry lumber will shrink in volume

to such an extent that they will often have to be taken up and relaid. If it is possible to do so, it is advisable to use a concrete base for the installation of these floors. The

base should be strong enough to carry the entire load and should be finished smooth and level so that it will not be necessary to use a cushion between the concrete and the blocks in order to secure a level floor and uniform bearing for the individual units.

The use of a sand cushion between the blocks and the concrete, which was almost universally used a few years ago, was largely accountable for a great many of the failures. Sand shifts easily under traffic and heavy loading and also affords pockets for the collection of moisture under the floor. Wherever a cushion is necessary between the concrete and the blocks, it is advisable either to use a mixture of portland cement and sand or a bituminous mastic. The

Note how the grooves permit the bituminous filler to penetrate the full depth of the joints on all sides when the blocks are laid up tightly together, thus binding the individual units into a compact monolithic surface.

If plain rectangular blocks are used and laid up closely together, it is almost impossible to get the filler between the blocks in sufficient quantity to be of any real value.

The success of any wood block floor depends upon the rigidity of the individual blocks. If the blocks remain tight and firm they will wear indefinitely. If they become loose under wear and tear they will disintegrate rapidly. Hence the necessity of getting the filler between the blocks.

latter is preferable in a great many cases on account of being both waterproof and elastic. The sole functions of a cushion should be to level up the inequalities of the base and, in the case of the bituminous cushion, to furnish a waterproofing membrane on the underside of the floor. It is standard practice today to lay the blocks directly upon a smoothly finished concrete base without any cushion whatsoever. It is also customary to give the base a

Note how the lugs provide a spacing around each block. This spacing allows the pitch filler to penetrate the full depth of the blocks, binding them firmly together, and making a thoroughly waterproof construction. This spacing also gives horses a chance to get a footing and provides a grip for automobile chains.

The lugs prevent bulging or buckling of the pavement as they compress when the blocks expand and relieve the pressure. Because the pressure is relieved, the creosote oil will not be forced from the pores of the wood.

Slipperiness, buckling, bleeding eliminated.

The lug makes a good block better.

successful waterproof binder in the joints of the blocks, thereby eliminating the possibility of shifting of the base and a loosening of the units, has permitted a reduction in the depth of the blocks used. Factory floors are now being very successfully installed throughout entire manufacturing plants with blocks as shallow as 2 in. in depth. Furthermore, the service obtained is superior to that obtained in

thin, even coating of coal-tar pitch before installing the blocks, so that the underside of the blocks may be thoroughly sealed and made waterproof.

The elimination of cushions and the use of a

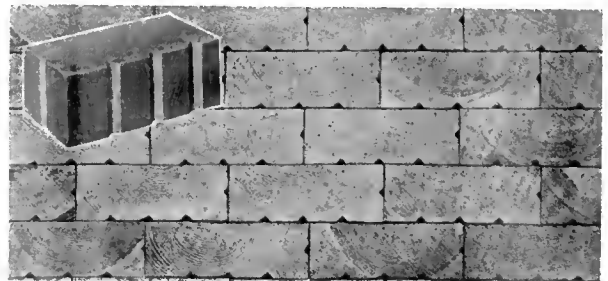

WOOD BLOCKS WITH GROVES

past years with blocks two or more times as deep where the weight of the blocks was depended upon to keep them down and in surface.

Successful installations may be made on timber and plank foundations in mill-type buildings, but care must be taken to see that the timber in the foundation is sound and that the blocks are afforded a firm and even footing. A bituminous-mastic cushion between the planks and the blocks is now being extensively used and is proving very successful.

For dry locations the blocks should be driven up-tightly together when installed; there is a tendency, however, for a slight further contraction in the volume of air-seasoned blocks when placed in the floor

of a steam-heated room and therefore it is necessary to provide a binder in the joints to hold the blocks in place after this contraction has occurred and to exclude moisture and foreign matter from seeping under them.

Creosoted wood-block floors are being installed in machine shops, forge shops, foundry molding and core rooms, casting cleaning and chipping rooms, warehouses, leather and paper mills, automobile assembly plants, garages, loading platforms, etc. The conditions in the above work vary from extremely dry to a saturated moisture state. They also vary from low to high temperatures, and in some cases the blocks are submitted to the action of molten metal. The extreme variation in the demands covered by the above list of industries gives a fair idea why it is necessary to study the individual job at hand and draw a specification to meet the particular work.

In machine shops the floor is often subjected to oils, gasoline, and various acids; in forge shops it is



WOOD BLOCK FLOOR IN INDUSTRIAL PLANT

subjected to vibration, to abrasion, and to contact with hot metal; in foundries the heat is often extreme and the blocks are frequently sprayed with sparks from molten metal at one part of the operation and with water a little later. In leather and paper mills portions of the floor are constantly flooded with water and acid solutions. In loading platforms the problems are similar to those in street paving—that is, the conditions are alternately wet and dry. In upper floors of reinforced-concrete buildings, and also in mill-type buildings, the blocks are usually submitted to extremely dry conditions which cause them to contract to their minimum dimensions. All of these conditions must be taken into account when designing the floor.

For ordinary factory purposes the proper treatment for the blocks is 6 lb. of creosote oil per cubic foot of timber. This is injected by the Rueping process and is sufficient to preserve them from decay. When they are to be subjected to considerable moisture or to the weather, they should be

treated with 12 lb. of oil per cubic foot of timber by a combination of the empty- and full-cell processes. This extra amount of oil insures better waterproofing of the blocks.

Floors which are to be subjected to considerable moisture, or to weather conditions, should be laid with ample provision for expansion. It is good practice to provide ample space between the individual units to take care of this expansion. These joints should be flushed full of a waterproof, elastic binder, which should preferably be coal-tar pitch of a consistency which will not soften up under atmospheric or room temperatures. Coal-tar pitch has proven the most successful binder and filler for creosoted wood blocks, as it is a derivative of the same base as creosote oil, and thus readily unites with the oil in the blocks.

It is universally conceded that wood-block floors are ideal when properly constructed. In view of the fact that a great deal of the success depends upon the design and construction of the floor, it has become standard practice for the block manufacturers to not only furnish blocks, but to take charge of their installation as well.

The Noyes-Buick Building

(Continued from page 211)

Pans have been used for many years in concrete floor construction, but they have not been used until recently in flat slabs, which are computed as such. Their use is apparently in accord with building laws everywhere and with the generally accepted theories of flat slabs except in one particular. This exception is in the removal of tension concrete from the mid-sections which the Boston building department has recognized as reducing the allowance of 18,000 lbs. per sq. in. on the tensile steel to 16,000 per sq. in. This is certainly conservative, as the Joint Committee are suspected of increasing the allowable steel stress for flat slabs, partly because of their particularly safe stand in other and less definite matters.

This form of cellular flat slab was proposed by Nils F. Ambursen in 1917, in connection with the Uniform System now made by the Blaw-Knox Company. It was patented in June, 1919, by Edwin F. Albright. Whatever the merits of the controversy which has arisen regarding this patent, Mr. Albright has done some very good pioneer work in perfecting details and erecting typical structures.

The general contractor for the Noyes-Buick building was the F. T. Ley Company, of Springfield, Mass., the architect, A. H. Bowditch, of Boston, Mass., and the writer was the consulting engineer, responsible for structural design.

Own Your Home Competition

The Jury of Award Announces Its Decision in the Various Classes

The nation-wide competition for designs of houses of low cost of four, five and six rooms, held by the managers of the Own Your Home Exposition, to be held in Chicago March 26-April 2, sponsored by leading architectural societies and federated art clubs, is now closed and the Jury of Award has announced its decision.

No important competition has in recent years been more widely participated in or more satisfactorily conducted. The general details of this competition have been published in earlier issues of THE AMERICAN ARCHITECT. The results, as announced by Mr. Henry R. Holsman, chairman, are as follows:

FRAME HOUSE

- 1st Prize Louis Justement, Washington, D. C.
 2nd Prize J. Ivan Dise and E. J. Maier, Detroit.
 3rd Prize Edmund J. Jacques, Detroit.
 4th Prize Walter F. Bagnor,
 Carl A. Rehse, Ass., Milwaukee.
 Mention John Floyd Yewell, New York.
 " Paul Hyde Harbach, Buffalo.
 " James A. Parks, Washington, D. C.
 " Robbins Louis Conn, New York.

BRICK HOUSE

- 1st Prize Edgar and Vera Salomonsky, New York.
 2nd Prize John Barnard, Boston, Mass.
 3rd Prize Henry F. Stanton and Charles Crombie,
 Detroit.
 4th Prize Ainslie M. Ballantyne, New York.
 Mention Johnson & Ford, Jamestown, N. Y.
 " Chauncey Hudson, New York.
 " Richard W. Powers, Boston.
 " Isador Richmond, Beechmont, Mass.

STUCCO HOUSE

- 1st Prize Louis Justement, Washington, D. C.
 2nd Prize Amedeo Leone, Detroit.
 3rd Prize Montgomery & Nibecker, Los Angeles.
 4th Prize Theo. Vischer and James Burley, archts.
 New York.
 Mention Alfred Cookman Cass, New York.
 " Edgar and Vera Salomonsky, New York.
 " Richard W. Powers, Boston.
 " Louis Justement, Washington, D. C.

GROUP PRIZES

- 4-Room Richard W. Powers, Boston.
 5-Room John Floyd Yewell, New York.
 6-Room J. Ivan Dise and E. J. Maier, Detroit.

Huge Parlor Stoves of Roumania

Mysterious Structures Tower to Ceiling

Visitors to Roumania who have occasion to enter some of the native homes are often impressed by a mysterious structure of enormous size, occupying a corner of the living room. This huge device, towering to the ceiling of the room, and quite ornamental in a dignified way, is a parlor stove. The fire door, and the amount of coal or wood fuel fed into it, are absurdly small in comparison with the total spread of radiating surface visible, and for that very reason the heaters are remarkably economical in everything but space.

Germany Wants Skyscrapers

Agitation for Them Strongest in Berlin and Munich

Agitation for the construction of skyscrapers has started in virtually every city in Germany, where for many months the housing problem has taxed the ingenuity of city officials, relief workers and flat-dwellers. Architects have drawn specifications for buildings to rival the tallest "Wolkenkratzer" in New York and sanitary and hygienic authorities are lecturing on the probable effect of the high buildings, darkened streets and congested business and residence centres.

Berlin and Munich have displayed much interest in the proposals.

Buildings in German cities were limited under the old regime to a uniform height. Few are more than four stories high. The tallest business building in Berlin is only five stories.

Dutch Dry the Zuyder Zee

Will Cost About \$250 Per Acre—500,000 Acres Will Be Reclaimed

After years of deliberation, the people of Holland, it is learned, have decided that they need more land. With characteristic energy they are proceeding to acquire it. The program contemplates the construction of a thirty-mile dike across the outlet of the Zuyder Zee and the gradual reclamation of parts of that body by means of smaller dikes and a filling-in and pumping process.

The damming of the north end of the Zuyder Zee presents difficulties not alone on account of the length of the dam but also because of the fact that the water depth varies from about thirty-five to ten feet. The foundation of the great dam will be, literally, billions of all sizes of tree branches, lashed together into great bundles. These will be sunk, forming a supporting mat of enormous area. Upon this will be placed a thick layer of coarse, crushed

stone, and on this powerful foundation will be reared the masonry of the dike. The structure will have a height, above water level, of from 16 to 17 ft., and will be wide enough across the top to accommodate a double-track railway line. It is expected that the completion of the entire project will require 35 years.

The expense, based on pre-war figures, would have been about \$88,000,000. However, later estimates place the figure nearer to \$125,000,000. As it is expected that productive land to an extent of approximately 500,000 acres will be reclaimed, it will be seen that the cost will be about \$250 per acre. Besides reclamation, an effect of the undertaking will be to convert the present salt-water Zuyder Zee into a fresh-water lake of an area of 600,000 square miles. Although of such great size, it will really be a controlled reservoir, impounding the flood waters of the River Yssel and connecting canals during the periods of the northwest storms, when they do not flow into the North Sea but overflow their banks, and releasing them through sluiceways in the great dike during calm weather.

Signs on Japanese Houses

Proof of Fire Insurance, Telephone, and "Great Cleaning" Proudly Displayed

In Japan one man learns a good many things about the resident of a house merely by looking at his door. According to police regulations the entrance to every residence must have a small wooden tablet affixed to it. This tablet has the name and number of the house on it, and on another tablet is the name of the responsible householder.

Sometimes, though rarely, the names of other inmates are placed over the door, but there is no police regulation that requires it, except in the case of boarding houses, which have to place their boarders' names outside for all to see. A person fortunate enough to possess a telephone always has the number proudly displayed over his entrance. Near it one will often see a quaint enameled or tin disk. That is the fire insurance mark. Every fire insurance company has its own special metal plate, which it nails to the lintel when it insures a house.

There are always several small pieces of paper pasted over the door, placed there by the police. One is to certify that the periodical oshoji, or great cleaning, has taken place. Another paper tells perhaps that the sanitary conditions are satisfactory. What others stand for is known only to the police themselves; that they give secret information about the inmates is certain.

Formerly it was the rule that if there was a well upon the premises the fact had to be proclaimed by

a square board marked with the character for well—ido. This was to show where people could obtain water in case of fire in the neighborhood. The regulation may still be in force in country places, but, owing to water's now being laid in pipes, it is no longer enforced in the cities.

Spanish Missions to be Restored

California Mission Restoration Association Will Do the Work—Father Mestres, Spanish Diocesan Padre, in Full Charge—Motor Trucks Dash Along El Camino Real

The Missions of California, famed in the history of civilization in the great West, and which sprang into existence nearly three centuries ago when zealous missionaries toiled northward over El Camino Real—the King's Highway—are to be revived.

The twenty-one missions, now decaying and in ruins, which lie along the highway from San Diego to Sonoma will be brought back to life through the activities of the California Mission Restoration Association, which is now instituting a movement to culminate only when the last mission has been restored in its ancient picturesque splendor.

Father Raymond M. Mestres, Spanish diocesan padre, who has devoted twenty-nine years of study to the Spanish missions of California and to actual work in these historic places, is in full charge of the restorative work under way.

Thus are the distinguishing marks in the beginning of civilization in the western half of the continent to be made permanent for posterity. Each of the twenty-one missions in the long, but unwavering chain is to be reconstructed and rebuilt as it was when first completed by the tireless Franciscan fathers and the Indians whom they civilized.

For years the missions of California have been the topic of historical discussion, and the food for the decaying ravages of time. At different periods attempts have been made to restore some of them, but these have been more or less desultory and there have been no permanent results.

The twenty-one missions were built between the years 1769 and 1823, along a trail over four hundred miles long. That trail, or El Camino Real, as it was known, is still existent—it is the highway from San Francisco to San Diego. But in the eighteenth century it was a burro path, a rude almost unrecognizable tracing on the ground. Today it is surfaced with asphalt and where the jogging burros plodded with their sacks of supplies to distant laboring missionaries, now powerful automobiles and trucks dash along on rubbered wheels. El Camino Real is still the highway.

Civilization dawned for California and for the

great West on July 1, 1769, when the four forces of the pioneering Spaniards met at San Diego and celebrated their successful undertaking. No sooner, states E. J. Crosby in his account in the San Francisco press, were the congratulations completed than the work of constructing a mission started. From that day forth California has been civilized.

The work of re-establishing these missions is now under way. From the archives of Madrid and from the Church records left by Father Junipero Serra the data has been secured by Father Mestres. All of his knowledge as mission historian, archaeologist and builder is to go into the completion of the great task before him, a task which, when completed, will find the landmarks of California the same as they were when first built along El Camino Real.

House Managers for the Dutch

Women Manage Octavia Hill System—Tenants Instructed in Use of Modern Home Fittings—Special Blocks for "Less Desirable" Groups

The city of Amsterdam, Holland, found itself forced, several years prior to the war, to start extensive re-housing plans for inhabitants of the oldest and most congested sections of the city. In spite of the war, it has completed some four thousand dwellings and has some six thousand more under construction. Built in part on purpose to house the poorest and most neglected members of the community, these properties presented an unusual problem of management.

After a study of the matter and a visit to England, Mr. Keppler, the chairman of the city's housing department, decided to adopt the Octavia Hill system of management and put this entirely into the hands of women. He was fortunate in finding two Dutch women who had been trained for such work in London; and there is now a staff of thirteen managers under a woman chief superintendent. In the assignment of tenements, care is taken, first, to provide adequate accommodation for families with several children. Some blocks are, in fact, reserved for families with five or more children; and families with a member suffering from tuberculosis are specially provided for in dwellings with a sleeping porch or garden.

Instruction of tenants in the use of modern home fittings, to which many of them have not been accustomed, is one of the managers' duties. The managers also co-operate with other voluntary agencies in further methods of home education and in rendering social service in various forms. Under

the city's scheme, which is expressly for the poorest, no "undeserving" families are excluded from these new houses; but if families are destructive, noisy, drunken, or do not pay their rents regularly, they may be removed into blocks specially set aside for the less desirable group. Here they are under strict supervision and subject to special educational efforts. While elsewhere a manager looks after two hundred families, the managers here are resident and are given not more than twenty-five homes to superintend. As the profession of house manager is new for women in Amsterdam, new members of this staff must attend courses at the University School of Social Work.

Personals

The American Architectural & Engineer Co. announce the opening of offices at No. 1, Yurakucho Itchome, Kojimachiku, Tokyo, Japan. Mr. L. M. Slack, formerly with Wm. W. Slack & Sons, Architects, Trenton, N. J., is managing director, and Mr. A. Raymond of New York City is the architect. Catalogues and samples are desired.

Bernard Wiseltier, Landscape Architect, has opened offices at 15 East 40th Street, New York City, where he will engage in the practice of his profession. Mr. Wiseltier, who is a Cornell University graduate, a member of the American Society of Landscape Architects, and a member of the Architectural League, was for a long time with Vitale, Brinckerhoff and Geiffert.

Noyes-Buick Building

(Continued from page 195)

weight as much as possible, the forms were steel domes about 2 feet square with concrete beams between them, reinforced in two ways. By this arrangement, it was possible to use a very thin slab over the top of the domes—in some instances this being reduced to 2 inches in thickness and in no case, even in the repair shop where a load of 250 pounds to the square foot was carried, was this slab made over 3 inches in thickness. In this way, a saving of from 30 to 40 per cent. was effected in the amount of concrete used and the reduction in weight made it possible to materially reduce the size of the columns and the footings below which resulted not only in speeding up the construction, but greatly reducing the cost of the same. The entire enterprise represents an investment in round figures of \$1,000,000.

Tabulation of Building Costs

Second of The American Architect's series of cost tables, figures for which were furnished by Architects throughout the United States, the first compilation appeared in the January 12 issue

Type of Bldg.	Location.	Type of Construction.	Equipment.	Foundations.	Total Cubic Feet	Contract Price or Bid Received Cu.Ft.	Cost Per Cu.Ft. Were Taken.	When Figures Were Taken.	Remarks.
School	Buffalo, N. Y.	Fireproof, concrete; walls, brick; floors, cement finish, reinforced concrete joists and tile.	Heating, split system (direct and indirect); lighting, electric; plumbing, vitreous china; elevators, electric.	Concrete.	2,412,135	\$1,157,825	48c.	Jan. 19, 1921	
School	Buffalo, N. Y.	Fireproof, concrete; walls, brick; floors, cement finish, reinforced concrete joists and tile.	Heating, split system (direct and indirect); lighting, electric; plumbing, vitreous china.	Concrete.	1,157,825	569,979	49.2c.	Jan. 19, 1921	
Factory	Troy, O.	Fireproof, reinforced concrete frame; walls, brick and steel sash; floors and roof, flat slab concrete.	Heating, steam from central plant; lighting, electric; plumbing, 2 toilet and wash rooms; elevators, 1 freight.	Concrete.	348,500	87,761.50	25.1c.	July, 1920	Two stories and basement.
Office Bldg.	Troy, O.	Composite construction; walls, brick; wood, floor ceiling, wood construction.	Heating, steam from central plant; lighting, electric; plumbing, 2 toilet rooms.	Unreinforced concrete.	66,310	25,828.30	39c.	Aug., 1920	Small, 1 story.
High School	Miles City, Mont.	Fireproof, concrete; walls, brick; floors, concrete.	Heating, steam, private plant; lighting, electric; plumbing, usual.	Unreinforced concrete.	900,000	225,000	25c.	Jan. 4, 1920	Six rooms.
Primary School	Buffalo, N. Y.	Non-fireproof; walls, brick; floors, wood.	Heating, split system; lighting, electric; plumbing, vitreous china.	Stone.	157,730	85,841	54.4c.	Jan., 1921	
Factory	New Haven, Conn.	Mill construction; walls, brick; floors, mill.	Heating, steam; lighting, electric; plumbing, usual; elevators, freight.	Stone.	299,500	69,000	23c.	Mar., 1920	
Residence	Dayton, O.	Brick veneer, stucco, non-fireproof; floors, basement, cement, others wood; roofing, special slate.	Heating, vapor; lighting, electric; plumbing, pressure system for soft water, city water drinking purposes 4 bath rooms, 2 toilets, vacuum cleaning system, 21 outlets.	Concrete, unreinforced.	122,702	100,280.50	81.9c.	Sept., 1920	
School (addition)	Buffalo, N. Y.	Fireproof, concrete; walls, brick; floors, cement finish on reinforced concrete and tile.	Heating, split system; lighting, electric; plumbing, vitreous china.	Concrete, unreinforced.	1,241,575	582,167	47c.	Jan. 19, 1921	
Residence	Dayton, O.	Frame; cement basement floor, others wood; shingle roof.	Heating, vapor system; lighting, electric; plumbing, pressure system; 3 bath rooms, 1 toilet room.	Concrete, unreinforced.	94,380	46,318.70	49.1c.	Mar. 2, 1920	
Bank	Piqua, O.	Semi-fireproof; walls, 2 ext. stone and granite, interior, old brick party walls; roof, wood construction and steel frame.	Heating, vapor system; lighting, electric; plumbing, pressure system.	Partly old new m a s s concrete.	113,840	63,693.40	55.9c.	May 1, 1920	Bank screen of marble and glass, marble wainscot.
Residence	Seattle, Wash.	Non-fireproof; walls, brick veneer; floors, oak, painted trim.	Heating, hot water; lighting, electric; plumbing, modern, shower alcove, roughing in for spare bath room.	Brick.	49,807	12,452	25c.	Nov. 10, 1920	
Residence	Evansville, Ind.	Non-fireproof; walls, frame; floors, oak.	Heating, steam; lighting, electric; plumbing, modern.	Concrete and brick.	30,000	12,000	40c.	Nov. 10, 1920	
Club	Franklin, Ind.	Non-fireproof; walls, brick on wood stone; floors, cork on wood joist.	Heating, steam; lighting, electric; plumbing, modern.	Concrete and brick.	437,500	180,000	41.1c.	Dec. 1, 1920	
Orphanage	New Orleans, La.	Fireproof, concrete; walls, brick; floors, concrete slab.	Heating, steam; lighting, electric; plumbing, modern, 2 kitchen, laundry.	Concrete spread footings.	137,940	82,730	60c.	Dec. 20, 1920	
Residence	New Orleans, La.	Non-fireproof; walls, wood frame, stucco, floors, wood joists, double floors, pine finish.	Heating, warm air; lighting, electric; plumbing, 2 bath rooms, kitchen, laundry.	Concrete spread footings.	35,280	10,226	28.9c.	Dec. 10, 1920	
School	Engervale, N. D.	Fireproof; walls, brick, tile (clay) steel studs non-bearing partition; floors, metal lumber; roof, suspended ceiling; floors, mastic finish.	Heating, one pipe steam, gravity; lighting, electric; plumbing, two pipe TP private septic tank.	Concrete.	81,186	32,000	39.4c.	Dec. 20, 1920	
Police Station	Dayton, O.	Fireproof; floors, reinforced concrete; walls, concrete and two old party walls; floors, concrete, cement finish.	Heating, city steam; lighting, electric; plumbing, 5 toilets (small person toilets and bath rooms).		118,480	35,917	30.3c.	Mar. 1, 1920	

Weekly Review of the Construction Field

With Reports of Special Correspondents in Regional Centers

Exemption From Taxation and Other Subsidies

Lawson Purdy, Former Chairman Board of Taxes and Assessments, Says Some Pertinent Things About Government Aid

AT this time, when a great deal of discussion is running rampant regarding "Government supervision," "Government control" and "Government ownership" of parts or the whole of the building industry, it is both interesting and to the point to note what those have to say who have been associated in one way or another with Governmental bodies, city, state, or national.

As former chairman of the New York City Board of Taxes and Assessments, Lawson Purdy spoke his mind rather freely at the National Housing Association's conference at Bridgeport recently.

After indicating that there are indeed times and periods when Government interference or regulation becomes necessary, Mr. Purdy said rather flatly:

"I am personally, constitutionally I suppose, opposed to interference by the State. I think the Government should mind its own business and keep out of private business that ordinary persons can perform."

The fields of zoning and the regulation of the use of land by cities and states, towns and villages, with the idea of protecting people in the proper use of that which they lawfully occupy he pointed out as legitimate fields for Government supervision or control.

As against this, however, Mr. Purdy emphasized the fact that when the Government goes into any business, competition ceases. Public opinion objects to the Government making a profit out of anything.

"Let Government build houses, if you please—how many private builders would compete with Government? Mighty few. Let Government start in the lending business, and we will have the same situation in that field. What private lender would compete with the United States, if the United States started to lend money?"

Speaking of exemption from taxation and other subsidies, Mr. Purdy pointed out that if, in New York, a 2½ per cent exemption existed, and one wished to put up a \$10,000 house on which he could borrow \$7,500, or 75 per cent., on which the 6 per cent. interest means \$450 per year. Then the lender

says: "I will let you have the money provided you will pay me annually 2½ per cent. of the cost of the house, which would be no more than you will save in taxes."

That would mean \$700 a year. In ten years 45 per cent of the loan would be paid, in 15 years 80 per cent, and in 17½ years the entire loan would be paid by paying annually a sum equal to 7 per cent. of the cost of the house.

"You will observe that it takes ten years to get rid of 45 per cent., and in the remaining five years of the 15-year period there would be 35 per cent. more paid off. It is the latter years that become so important under an amortization plan, because a large part of the principal has been paid, and that is one of the reasons why, personally, I regard it as a great advantage . . . that the exemption should be reasonably long. It is inconceivable to me that any lender who can afford to lend on an amortizing mortgage, would not prefer the contract of \$7,500 on a \$10,000 house with \$700 a year paid on interest and principal, than to lend half the value of the house with doubt as to the payment of the principal."

Mr. Purdy pointed out that if, in ten years, building costs should come down to what they were in 1914, then a 50 per cent. loan today would be in ten years a 100 per cent. loan. He cited this, presumably, to show why such caution is exercised by the loaning institutions are so "prudent about the money of others."

(Special Correspondence to THE AMERICAN ARCHITECT)

SEATTLE.—Investment and home builders of the North Pacific coast territory are inclined this week to await pending adjustments in the industrial field, there being some controversy between carpenters and sheet metal workers over the wage scale to be adopted for the 1921 building season.

Architects have gleaned from conversation with these investors that it is believed that the cost of building materials have reached bottom for at least the first half of the year, but that wages for skilled labor are still hovering round the war-time base and must recede before actualities may be brought into play and closed contracts replace pencil sketches.

Employing contractors believe carpenters will be working for less than \$6.40 a day, the figure assented to in part, before early summer. As an indication, fir lumber mills that are resuming business after a closedown of 30 days or more, have put it

THE AMERICAN ARCHITECT

squarely to the men that if they care to work at \$2 to \$2.50 per day the plants will start. Otherwise not, because of the fact that there is little present demand for lumber and there is a larger problem for the employer than the employee. In a few instances this wage has been accepted and the mills have started.

The Corporation steel prices prevail this week in sheet metals and galvanized pipe, and the supply is ample in practically all sizes for the late winter needs. Jobbers have been cautious about overbuying, but should a brisk demand exhaust stocks, it will be easy to get speedy delivery from the mill as prompt execution of orders is now reported all along the Pacific Coast. The supply of three-quarters and halves of galvanized pipe is complete, and this fact is pointed to as an indication of the condition of delivery. It is recalled that during the last two quarters of 1920 it was almost impossible to get these sizes. An occasional offer under the corporation price in sheets is received, but this is held to be brokerage operations supplied by outside mills.

The fir lumber market suffered slight recessions for the week, with common dimension 50 cents lower. Eastern buyers who have received these lists have taken it as an indication of a horizontal price reduction and are keeping aloof. The wage reduction in the mills may permit of slight recessions, but fundamentally the market is steady.

The supply of building material is normal for February. All the cement plants of the state are in operation, and all are holding storages of stock ahead. Building projects are being retarded by the attitude of the banks, who are slow about making loans and on renewals are asking that loans be taken up.

The plant of the Superior Portland Cement Company at Concrete, Wash., will resume operations next week with a complement of 200 men and a production of 4,000 barrels a day. A new crusher, with a capacity of 1,000 tons per hour, has been installed.

The Master Painters and Decorators have decided upon a wage reduction of 12½ per cent. effective this week in Seattle. Wages of painters and decorators will be \$7 in place of \$8. As previously announced by the AMERICAN ARCHITECT, wages of building trades workers were reduced 20 per cent. on February 1.

At their annual meeting here Saturday night the members of the Washington Chapter of the American Institute of Architects elected officers as follows: Charles Allen, president; David J. Myers, first vice-president; A. J. Russell, of Tacoma, second vice-president; H. C. Whitehouse, of Spokane,

third vice-president; Harold G. Sexsmith, secretary; Carl Siebrand, treasurer, and J. S. Cole, member of the board of trustees, all of Seattle excepting where otherwise stated. Wm. G. Purcell, president of the Oregon Chapter and R. M. Dyer of the Association of Engineers, were honorary guests. Henry Kendall of Boston, president of the national organization, and Robert D. Kohn, a director, of New York, were principal speakers of the evening.

(Special Correspondence to THE AMERICAN ARCHITECT)

CHICAGO.—While the actual opening of the building boom seems to be late in getting started there is no denying the fact that Chicago is being constantly reminded of the need of building. Apartment owners and real estate agents have been passing around renewal notices for the apartment leases which expire with the May 1 moving day and these notices have been very poignant reminders that Chicago needs more buildings. Increases are noted in every part of the city and the amount of the increase is by far the most sweeping yet reported. The situation is so acute that tenants are binding themselves into organizations to find a way out, while real estate agents and owners are organizing to combat the menace of an uprising of the tenantry. The tenseness of the situation is providing columns of hot stuff for the daily newspapers and the subject is by way of becoming the most absorbing topic in the conversation of this thriving metropolis.

One of the aldermen of the city has gone so far as to advise tenants to resist unfair rent boosts and to remain in the apartments, tendering the old payment of rent. When the sheriff comes to throw out the furniture the alderman advises recourse to the courts and a demand for a jury trial which he insists will delay the matter so long that the owner will be forced to compromise. The apartment owners are resisting just such a step by sending out leases that are leak-proof. One of the rights which the landlords are asking the tenants to forego is the right of demanding a trial by jury in case of any legal unpleasantness. And so it goes, tit for tat all over the town. Everybody sees the need of building, almost everybody is feeling the pinch of the housing shortage and yet nothing seems to be assuming definite shape for a lifting of the building ban.

That the spring will bring some building is undeniable, but here and there some of the experts in such matters are predicting that the big boom will not come until 1922.

Architects and contractors are beginning to advise their clients that there is nothing to be gained by the delay, however, because they feel that a building can be erected now at as small a cost as will prevail for the next five or six years. The point out

that lumber has been deflated as to price and that materials, while not as low as might be desired, are about as low as they can come under present freight rates. Labor is holding its old schedule in the building trades, but the individual efficiency has jumped tremendously. Masons handling common brick were satisfied with laying 500 brick per day during the flush times, but they are now laying as high as 2,000 a day without thinking anything about it. All of this cumulative advice is having its effect, particularly upon the prospective home builder, in which line of the work the chief activity this spring is likely to be noted.

Building money is continuing to prove an obstacle, but there is a feeling, too, that the money situation is growing less stringent as the business condition adjusts itself and the hope is somewhat general that money will be available.

One of the interesting suggestions for the relief of the building situation comes from an industrial writer on one of the daily newspapers. He suggests "building bees" with the idle building trades workmen assisting each other in the construction of homes. Following the suggestion, the Chicago Trust Company, a leading banking institution, made an offer to provide \$5,000,000 to provide a fund for building homes under the co-operative plan. This makes available sufficient funds for 2,000 small homes if the workmen can get together on a working basis and arrange a plan for taking advantage of the offer.

Investigation of an alleged building materials ring has been asked in the state legislature at Springfield in behalf of Chicago. The operations of the alleged ring have recently been made the subject of a federal investigation from which some forty indictments resulted. A fuller exposé of the methods is now requested with the hope of permitting a greater influx of open shop materials from other manufacturing cities nearby and a consequent reduction in building costs. The matter is now pending.

Aside from the special items previously outlined, there is nothing of great interest in the building situation. Architects report a considerable inquiry on new work, for figures and tentative sketches, but the amount of work on the boards remains low. No projects of importance have been outlined of late, and while work goes ahead on some of the larger buildings in Chicago, there is nothing to indicate an immediate resumption of activity.

In this market, lumber and materials hold at practically the old levels. One of the larger western manufacturers of lumber has made an official announcement of a shading of prices, but local dealers say that these reductions have been discounted by the fact that competing manufacturers have written down the prices without announcement. Inquiry for

lumber continues to improve, but spot business is very slight in volume.

In the minor building materials, much the same situation prevails, with a consequent stability of prices.

Quotations on lumber and materials in this market are as follows:—

Yellow Pine: B. & B. 1-in., \$95 to \$130, depending on thickness; 2 x 4, No. 1, 10 to 16 ft. length, \$51 to \$53; 2 x 6, \$48; 2 x 8, \$50; 2 x 10, \$53; 2 x 12, \$55; 13-16 x 3¼ z & b flat flooring, \$85 to \$90; 1 x 6, No. 2 common, \$48 to \$90. *Douglas Fir*: 2 4 S, in sizes up to 12 x 12, in length up to 32 ft., \$65 to \$70; 14 x 14, \$68 to \$73; 16 x 16, \$72 to \$75; 18 x 18, \$75 to \$80. *Hard Maple*: Four, ¼ No. 1 and 2, \$135; select, \$120; No. 1 common, \$100; No. 2 common, \$65; No. 3 common, \$32. *Birch*: Four ¼ No. 1 and 2, \$160; select, \$133 to \$138; No. 1 common, \$95 to \$100; No. 2 common, \$60 to \$65; No. 3 common, \$40. *Red Gum*: Four ¼ No. 1 and 2, \$150; No. 1 common, \$90 to \$92; No. 2 common, \$45.

Face Brick—Standard, vitrified red, \$32.00@34.00; Smooth, Indiana red, \$38.00@40.00; Smooth, Ohio red, \$38.00@40.00; Smooth, Pennsylvania red, \$46.00@48.00; Smooth, buff, \$45.00@47.00; Smooth, gray, \$47.00@49.00; Rough, buff, \$44.00@46.00; Rough, gray, \$47.00@49.00; Variegated, rough texture, \$34.00@49.00.

Common brick, \$16.00 per M. Portland cement, \$3.00 per bbl. Torpedo—Lake and bank sand, \$3.50 per yd. Crushed stone, gravel screenings, \$3.50 per yd. Hydrated lime, Ohio, paper, \$22.00 per ton. Hydrated lime, Ohio, cloth, \$29.00 per ton. (Includes sacks at 30c. each.) Hydrated lime, Wis. paper, \$19.00 per ton. Bulk lime, \$1.65 per ton.

(Special Correspondence to THE AMERICAN ARCHITECT)

BOSTON.—Contracts awarded in New England during January amounted to \$8,196,000 or nearly double the number contracted for during a like period in 1919.

Here in New England neither intense optimism nor intense pessimism is justified. It is a time of growing confidence, a time for courage. The shoe factories are comparatively busy after a period of idleness. The cotton goods industry is relatively busy and the woolen and worsted trade is picking up.

There is still a lack of confidence in some centers which prevents buying going forward for supplying the needs of the future. Forecasting the future to them is risky. So they are buying on a hand-to-mouth basis. The shoe factories have orders on hand sufficient to keep them running a couple of months. But they have no spring business and whether the necessary orders to keep these plants

busy will come in later is problematical. The manufacturers will make shoes only against actual orders.

There have been several meetings between representatives of the striking building mechanics and the employing contractors this past week but little or no progress was made toward a satisfactory settlement. Every building project of note in Boston and vicinity is completely tied up, due to the strike.

Architects and engineers are progressing with plans and specifications so as to be in a favorable position to go ahead with work now in prospect as soon as the labor difficulties are settled.

Saving Millions

The most sweeping move toward economy yet taken by Congress was shown in the recent action of the Budget Committee in reporting the Legislative, Executive and Judicial Appropriation bill with Federal employes in the District of Columbia reduced by 10,683, effecting a proposed yearly saving of more than \$30,000,000.

The bill does not provide for salaries for the next fiscal year for 12,183 Federal employes here, but provides for 1,500 additional employes for the Internal Revenue Bureau, so that the net reduction amounts to 10,683.

In addition to demanding the elimination of this army of war workers, the committee recommends that bonuses of \$240 a year in the next fiscal year shall not apply to workers at the Washington Navy Yard, whose wages are determined by wage scale adjustments from time to time.

Republican leaders say the total reductions in the employes in the District will reach fully 20,000 before the middle of the next fiscal year. They are unwilling to make further cuts in the salary roll until the special committee recently appointed to consider the elimination of unnecessary Government bureaus reports. This report is expected to be presented to Congress early in June, soon after which

further reductions will be made in accordance with the expected recommendations.

The bill carries appropriations amounting to \$112,705,748.75 for the fiscal year 1922, which is a reduction of \$5,751,461.36 from the amount carried last year and \$23,746,866.22 less than the amount sought in the estimates submitted to Congress by the departments affected.

Government Debt Steadily Shrinking

The gradual reduction in the public debt of the United States since August, 1919, when the high point was reached, is shown in the following table:

(Figures in Millions of Dollars)

Month	Total Gross Debt	Floating Debt (Unmatured Loan and Tax Certificates)
August 31, 1919.....	\$26,597	\$3,938
January 1, 1920.....	25,837	3,262
June 30.....	24,299	2,486
July 31.....	24,223	2,434
August 31.....	24,325	2,571
September 30.....	24,087	2,348
October 31.....	24,063	2,337
November 30.....	24,175	2,475
December 31*.....	24,010	2,317

*Estimated.

Figures are given on the basis of the daily statements of the Treasury Department, with an estimate of the debt as of the end of the year. The decline from maximum to December 31, 1920, was approximately \$2,590,000,000 or 9.7 per cent.

The greater part of the debt reduction has been effected in the floating debt which is composed of unmatured loan and tax certificates of indebtedness. The decline in the outstanding volume of these certificates since August 31, 1919, was \$1,621,000,000, a reduction of 41.2 per cent. During the calendar year 1920 the decline was \$945,000,000, a reduction of 28.9 per cent.

222

front piece to 16. 2358



INTERIOR OF CHOIR OF STA. MARIA DEI MIRACOLI, VENICE, ITALY

THE AMERICAN ARCHITECT

VOL. CXIX

WEDNESDAY, MARCH 2, 1921

NUMBER 2358



THE MAIN BUILDING, VIEWED FROM THE NORTHEAST
RESEARCH AND EDUCATIONAL HOSPITALS OF THE STATE OF ILLINOIS, CHICAGO
RICHARD E. SCHMIDT, GARDEN & MARTIN, ARCHITECTS

The Research and Educational Hospitals of the State of Illinois

Richard E. Schmidt, Garden & Martin, Architects

THE conception and development of an idea which involves a building is the why of the plan. Ideas generally follow well defined lines and can be segregated into groups, the individual members of which have but little variation—thus precedents are formed. This stabilization of ideas is desirable and necessary to progress, as it gives a basis from which departures safely can be made. When a plan is developed which has unusual elements and arrangements, it becomes especially interesting to understand the why of the plan. In order to comprehend this, the conception and development of the underlying idea must be explained.

The plans for the Research and Educational Hos-

pitals of the State of Illinois are unusual in many respects. This is due largely to the combination of elements not usual to hospital designing. The existing state hospitals for the insane were found by Mr. Charles H. Thorne, director of the Department of Public Welfare, to be places where patients were housed and given only incidental treatment. Apparently no effort had been made along the lines of research and preventative treatment. The logical conclusion is that, as the population of the state increases the capacity of these institutions must be enlarged in a like ratio and actually in an increasing ratio, thus adding to the burdens of the state to provide for its unfortunates. Mr. Thorne has stated that "it

THE AMERICAN ARCHITECT

WEST TAYLOR STREET

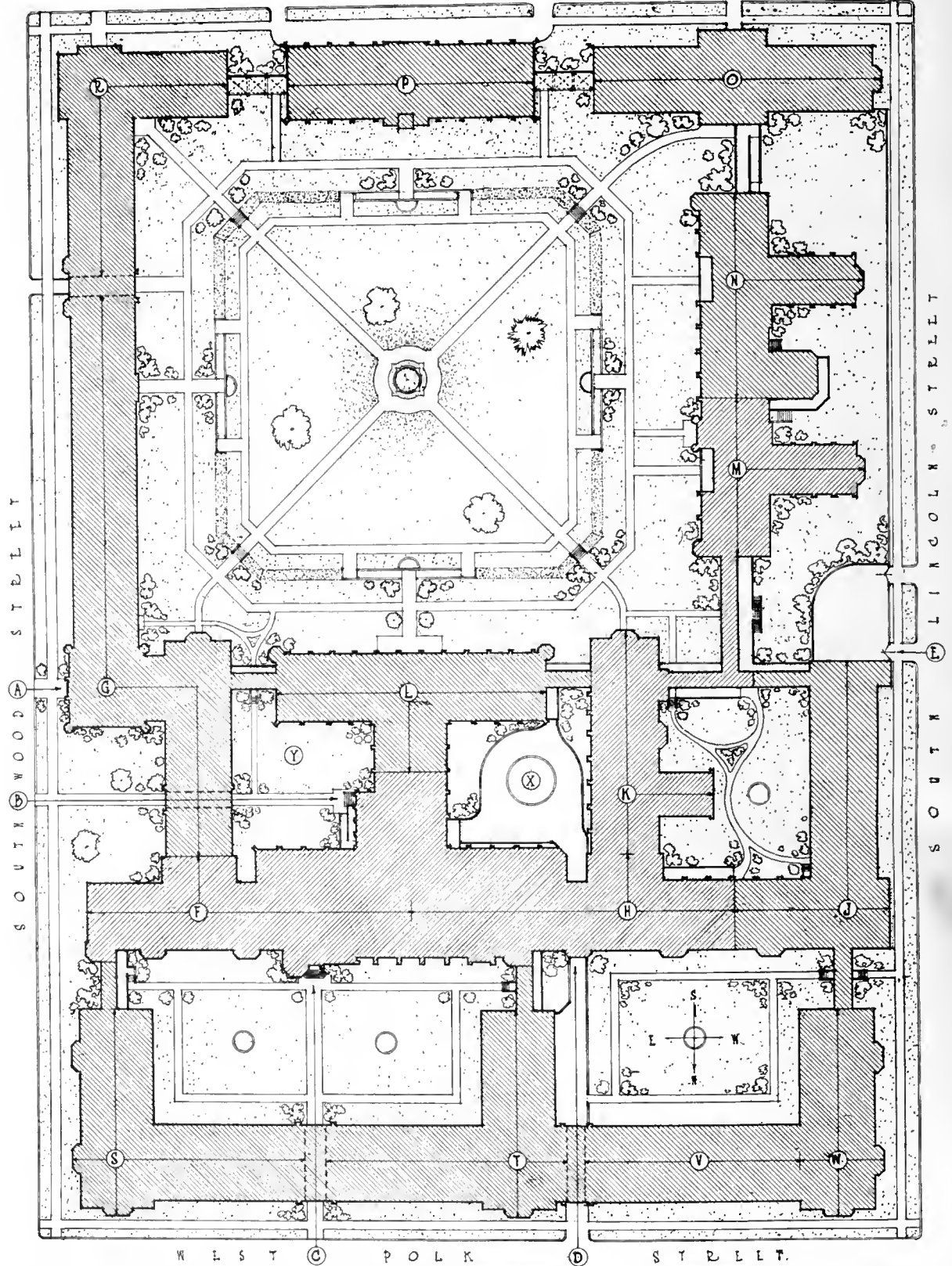

WEST POLK STREET

* RESEARCH & EDUCATIONAL HOSPITALS OF THE STATE OF ILLINOIS *
 - EDGAR MARTIN, SUPERVISING ARCHITECT - RICHARD I. SCHMIDT, GARDEN & MARTIN ASSOCIATE ARCHITECTS -

BUILDINGS NOW UNDER CONSTRUCTION: [hatched pattern] SCALE: 1" = 100' FEET. FUTURE DEVELOPMENT: [stippled pattern]

(A) ADMINISTRATION ENTRANCE (B) OUT PATIENTS ENTRANCE (C) STUDENTS & NURSES ENTRANCE (D) AMBULANCE ENTRANCE (E) KITCHEN ENTRANCE
 (F) CLINICAL INSTITUTE (G) EXTENSION OF CLINICAL INSTITUTE (H) EYE & EAR INFIRMARY (I) EXTENSION OF EYE & EAR INFIRMARY
 (J) PSYCHIATRIC INSTITUTE (K) ADMINISTRATION BUILDING (L) ORTHOPEDIC INSTITUTE (M) EXTENSION OF ORTHOPEDIC INSTITUTE
 (N) INFECTIOUS DISEASES (O) POWER PLANT (P) VENEREAL DISEASES (Q) RESEARCH INSTITUTE (R) LIBRARY CLASS ROOMS & RESEARCH LABORATORIES
 (S) CLASS ROOMS & LABORATORIES (T) DENTAL INSTITUTE (U) AMBULANCE COURT (V) DISPENSARY COURT

4/3/1920.



BIRDSEYE VIEW FROM THE NORTHEAST
RESEARCH AND EDUCATIONAL HOSPITALS OF THE STATE OF ILLINOIS, CHICAGO
RICHARD E. SCHMIDT, GARDEN & MARTIN, ARCHITECTS

seems obvious enough that any activity, whether state or private, which spends one-fifth of its revenue upon a single thing, should know something about that thing and should spend a considerable sum for the purpose of ascertaining causes, with the idea of reducing the cost. Why has not the state conducted research for humans with the same interest as it has for hogs? This has been a current question in Springfield for some time, and I think the answer is that research on hogs has been conducted by the University, whereas the research on humans has been attempted by an administrative department which is not trained or equipped to do so."

It became patent that research must first be undertaken by a competent agency, and that it was not the function of the Department of Public Welfare, an administrative organization. The College of Medicine of the University of Illinois is organized for the purpose required and it needed exactly the things the Department possessed—namely, hospitals. A joint agreement was entered into between the University and the Department of Public Welfare, obligating the former to furnish the professional service and the latter to undertake the administrative functions of the hospital group.

Prior to this, the rebuilding of the Illinois Charitable Eye and Ear Infirmary and the locating of a Surgical Institute for Children was under consideration by the Department. This condition was the cause of planning other activities so as to ultimately build a complete medical center. This will serve the purpose of affording every facility for research to determine the cause of and the development of methods for the prevention of disease. It will also serve as a source of those trained specialists needed by the Department. The general plan contemplates the housing of a school of medicine and dentistry with the necessary lecture rooms, libraries and laboratories; a clinical hospital wherein research work can be conducted in all branches of general medicine and surgery, including orthopaedics and psychiatry.

Governor Lowden was most fortunate in securing the services of Mr. Thorne as director of the Department of Public Welfare. Although he was without knowledge of the subject, he was an executive of one of America's greatest mercantile establishments, a man of liberal education and culture, and entered upon his work unhandicapped by the traditions, precedents and bias of special training. Edgar Martin, supervising architect of the State of Illinois, and Richard E. Schmidt, Garden & Martin, associate architects, prepared the plans. The planning was done in co-operation with Dr. Albert C. Eycleshymer, dean of the College of Medicine, University of Illinois. The results so far achieved have more than justified their connection with the project and

guarantees the successful completion of the undertaking.

The hospitals are being constructed on the site of the old West Side (Cubs) Ball Park, which has a frontage of 556 feet on West Polk street and extends 880 feet south to West Taylor street, and contains about ten acres. The hospitals will be erected in units, four of which are now under construction. The general layout is shown on the block plan. The research institute, library, class rooms and research laboratories and the dental institute will face West Polk street, with three wings extending south about 200 feet to the group of buildings now under construction. These are the clinical institute, the eye and ear infirmary, the psychiatric institute and the orthopaedic institute. In the rear of this group will be located the administration building. A wing of the eye and ear infirmary will be between the psychiatric institute and the street. These buildings will cover about one-half of the site and enclose five large courts. The remainder of the site consists of a very large quadrangle about 350 by 375 feet in size, affording a suitable outdoor place for the patients. This is especially desirable, as the hospitals are located in a very congested district. On the west of this quadrangle is located the orthopaedic institute; on the south, from west to east, the infectious diseases building, the power plant and the venereal diseases building. The buildings on the east are not yet definitely apportioned. The quarters for the patients will face this quadrangle and the utility and service rooms will face the streets.

A study of the five entrances indicated on the block plan shows that there will be no interference in traffic. The ambulance entrance at "D" is inclined and the incoming patients are delivered at the basement level in an enclosed room. The turning court, "X," is also at the basement level and makes it possible to secure very well lighted rooms about its four sides.

In general the buildings will be three stories in height, with a basement pipe space, and a fourth story occupying the lower portion of the space enclosed by the pitch roof; an interesting structural device by which the roof load is carried on inclined struts resembling flying buttresses, with a curtain wall set back from the building line. This permits the development of this fourth floor or roof space with light and air equal to that of the floor below. It also provides a very desirable outdoor space. This is illustrated in the detailed sections. Communication over the entire area is secured by a system of corridors slightly below the level of the pipe spaces. In general, these corridors will be against the outside walls with ample light and air. The first floors are about five feet above the outside grade, making it possible to have basement windows above grade, without areas. All interdepartmental communica-

THE AMERICAN ARCHITECT

tion, passage of visitors, transmission of food, laundry and supplies will be through the communicating corridor system, thus insuring ward privacy and a minimum of interference.

The out-patient department will be, in most cases, the receiving department of the hospital. There will be chosen from the great mass of clinical material passing through it the selected cases to be transferred to the wards for future study and treatment. This source of supply for clinical material has caused

passage of the patients through the various departments without interference and congestion. In fact, this department is so skilfully planned that it is worthy of careful study. Industrial architects plan to "route the product" through the factory. In like manner the product has been as carefully routed through this hospital. Its success effects economy in cost of operation, mental and physical effort. Elevators afford access to the X-ray department on the second floor and to the hydrotherapy and electro-



THE PSYCHIATRIC WING VIEWED FROM THE QUADRANGLE
RESEARCH AND EDUCATIONAL HOSPITALS OF THE STATE OF ILLINOIS, CHICAGO
RICHARD E. SCHMIDT, GARDEN & MARTIN, ARCHITECTS

the planning of the dispensary to receive special attention as one of the most important features of the scheme. The dispensary will occupy the entire first floor of the first section of the main building and can be extended into adjoining units to be built later. The general clinics will occupy the east half of the building, the eye and ear clinics the west half, the psychiatric and orthopaedic clinics the east and west halves of the psychiatric wing. From the main entrance at the rear of the center, the patients are distributed to the various waiting rooms as classified. Ample provision is made to effect the rapid

therapy department at the basement level. A small lecture room, with a capacity of about one hundred, is provided for lectures and demonstrations for out-patients and for the use of students and nurses.

The wards are located on the second and third floors. These are kept small as best adapted for teaching purposes. A ward capacity of four beds was adapted as the proper size, with a floor area of 320 square feet, and this led to the choice of a bay 16 feet wide by 20 feet deep as the typical unit for the entire scheme. In the eye and ear infirmary a ward for eight beds is the unit. The second and

THE AMERICAN ARCHITECT

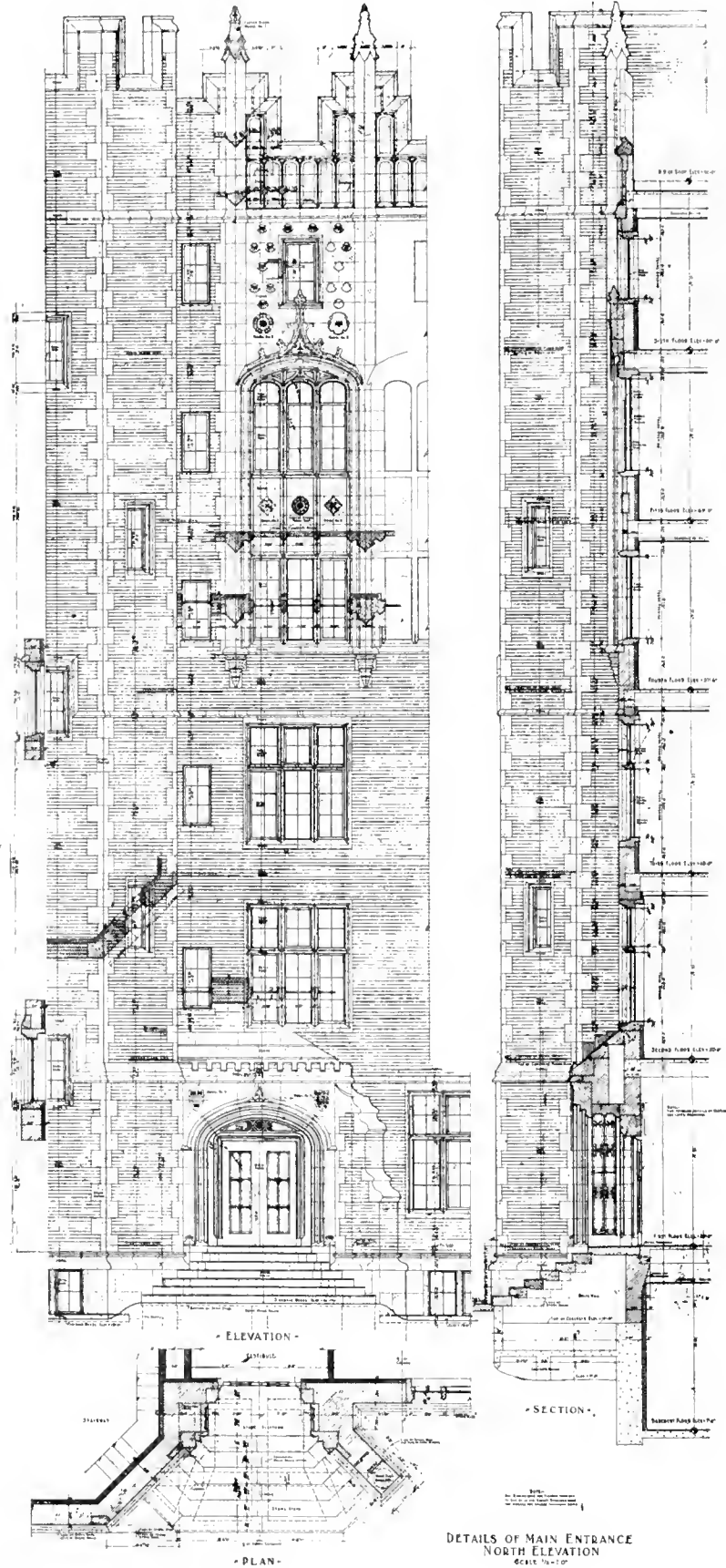

RESEARCH AND EDUCATIONAL HOSPITALS OF THE STATE OF ILLINOIS, CHICAGO
RICHARD E. SCHMIDT, GARDEN & MARTIN, ARCHITECTS

THE AMERICAN ARCHITECT

third floors of the psychiatric wing are assigned to male and female patients. The plan was governed by the special nature of the work and the space is divided in the reception quiet and disturbed wards. Access to the hydrotherapy department on the basement level and to the large solarium for occupational therapy and recreation on the fourth floor level is by means of elevators.

The central portion of the fourth floor is devoted to the operating department, which has a capacity sufficient for the entire group when completed. There are six operating rooms with side and top light combined and two smaller operating rooms with side light only, with all of the requisite utility and service rooms. The student amphitheatres seat from sixteen to forty each and access thereto is by means of stairs from the fifth floor. This keeps the operating corridor free from unnecessary traffic.

The eastern portion of the fourth floor is devoted to wards for children and infants; the western portion is used as day quarters for eye and ear patients and a small ward unit. In the psychiatric portion of this floor are research and demonstration rooms and two interns' rooms for the psychiatric staff.

On the fifth floor are wards for obstetrics and gynecology and on the sixth floor are quarters for resident physicians. Temporary quarters for interns are on the third floor of the main building in space ultimately intended for libraries and laboratories.

Each floor of the main building will have direct access to the corresponding floor in the buildings to be erected on the West Polk street frontage to contain the libraries, lecture rooms and laboratories of the medical school. The basic idea of the institution is the close association of the patient with the research physician and investigative worker, and by this means it will be accomplished.

The ward pavilion type is desirable for the Orthopedic Institute, as the patients stay for a considerable length of time and in this way a greater number of patients are accommodated. The south wards are for girls and the north wards are for boys. The first floor is devoted to ambulatory patients, day rooms and dining rooms. The grade of the quadrangle at this place is raised to the first floor level in order that the wheeled chairs may pass out thereto without difficulty. The second floor is devoted to bed patients, the third floor is devoted to first and second observation wards. The fourth floor contains, in the central and southern portion, study and class-

rooms for manual training and other forms of occupational instruction, as well as instruction in grammar school grades. There is also a large kindergarten and playroom which is equipped with a stage for moving pictures and theatrical performances given by the children. All of these rooms open onto balconies and roof spaces through French windows, so that advantage can be taken of the open air and sunlight.

There are three isolation wards located in the north end of this floor, for the use of children who may develop contagious diseases and at the same time continue their orthopedic treatment. Each ward has its own serving pantry and combined utility, toilet and bathroom. Separate entrances for nurses and doctors with adequate facilities for the prevention of cross infection are provided.

The buildings are designed in a free adaptation of English collegiate gothic, which always has an atmosphere of peace and quiet particularly suitable for academic and hospital institutions. In this particular case the location is in a congested and not overly attractive district and the plan was made with a view to provide the sick and convalescent patients with the advantages of the quiet and sheltered courts and quadrangle. This group will be a welcome contrast with another large hospital group bedecked with an ostentatious display of columns, cornices, pediments and pavilions—typically institutional in aspect and indicating an opulent charity towards its inmates.

The exterior walls are faced with a wire-cut Illinois brick which presents a variety in color and texture to approximate the charming weathered effect of old English brickwork. Bases, string courses, copings and window trim are of Indiana limestone. A fire-flashed interlocking shingle tile, with predominating tints of purple and russet brown, is the roof covering. Ornamentation has been reduced to a minimum, dependence being placed on the proportion of parts and the proper selection and use of materials for effect. The buildings are of fire-resisting construction throughout and of the most permanent and durable character.

On the whole, these plans are of great interest to architects, whether they are directly interested in hospitals or not, to physicians and hospital managers and to the layman. A careful study of them discloses the clever and intelligent planning which, when fully comprehended, is appreciated. When completed, these hospitals will rank equal with any of their kind in America, if not in the world.

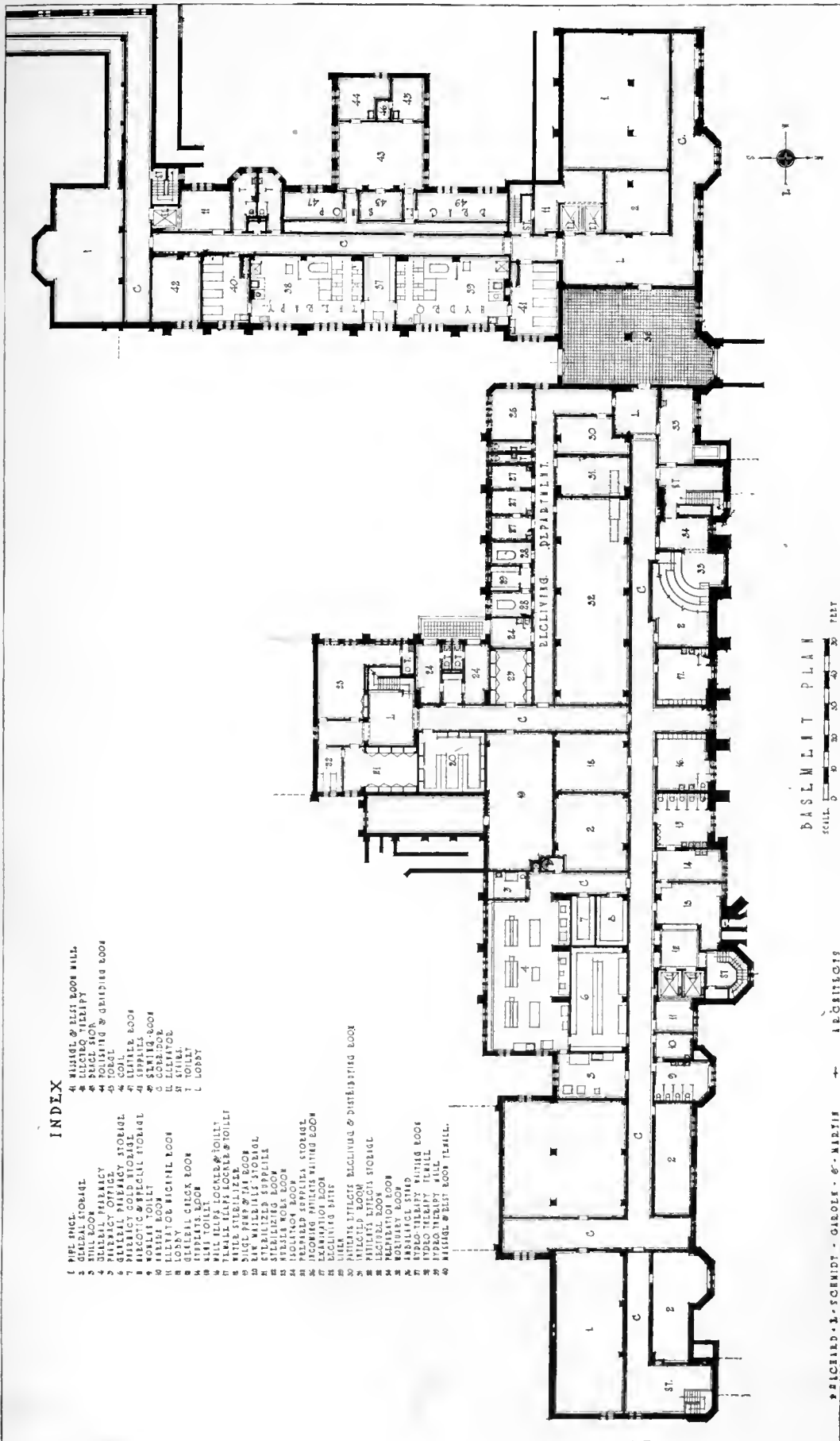

INDEX

- 1 RECEPTION LOBBY
- 2 RECEPTION LOBBY
- 3 RECEPTION LOBBY
- 4 RECEPTION LOBBY
- 5 RECEPTION LOBBY
- 6 RECEPTION LOBBY
- 7 RECEPTION LOBBY
- 8 RECEPTION LOBBY
- 9 RECEPTION LOBBY
- 10 RECEPTION LOBBY
- 11 RECEPTION LOBBY
- 12 RECEPTION LOBBY
- 13 RECEPTION LOBBY
- 14 RECEPTION LOBBY
- 15 RECEPTION LOBBY
- 16 RECEPTION LOBBY
- 17 RECEPTION LOBBY
- 18 RECEPTION LOBBY
- 19 RECEPTION LOBBY
- 20 RECEPTION LOBBY
- 21 RECEPTION LOBBY
- 22 RECEPTION LOBBY
- 23 RECEPTION LOBBY
- 24 RECEPTION LOBBY
- 25 RECEPTION LOBBY
- 26 RECEPTION LOBBY
- 27 RECEPTION LOBBY
- 28 RECEPTION LOBBY
- 29 RECEPTION LOBBY
- 30 RECEPTION LOBBY
- 31 RECEPTION LOBBY
- 32 RECEPTION LOBBY
- 33 RECEPTION LOBBY
- 34 RECEPTION LOBBY
- 35 RECEPTION LOBBY
- 36 RECEPTION LOBBY
- 37 RECEPTION LOBBY
- 38 RECEPTION LOBBY
- 39 RECEPTION LOBBY
- 40 RECEPTION LOBBY
- 41 RECEPTION LOBBY
- 42 RECEPTION LOBBY
- 43 RECEPTION LOBBY
- 44 RECEPTION LOBBY
- 45 RECEPTION LOBBY
- 46 RECEPTION LOBBY
- 47 RECEPTION LOBBY
- 48 RECEPTION LOBBY
- 49 RECEPTION LOBBY
- 50 RECEPTION LOBBY
- 51 RECEPTION LOBBY
- 52 RECEPTION LOBBY
- 53 RECEPTION LOBBY
- 54 RECEPTION LOBBY
- 55 RECEPTION LOBBY
- 56 RECEPTION LOBBY
- 57 RECEPTION LOBBY
- 58 RECEPTION LOBBY
- 59 RECEPTION LOBBY
- 60 RECEPTION LOBBY
- 61 RECEPTION LOBBY
- 62 RECEPTION LOBBY
- 63 RECEPTION LOBBY
- 64 RECEPTION LOBBY
- 65 RECEPTION LOBBY
- 66 RECEPTION LOBBY
- 67 RECEPTION LOBBY
- 68 RECEPTION LOBBY
- 69 RECEPTION LOBBY
- 70 RECEPTION LOBBY
- 71 RECEPTION LOBBY
- 72 RECEPTION LOBBY
- 73 RECEPTION LOBBY
- 74 RECEPTION LOBBY
- 75 RECEPTION LOBBY
- 76 RECEPTION LOBBY
- 77 RECEPTION LOBBY
- 78 RECEPTION LOBBY
- 79 RECEPTION LOBBY
- 80 RECEPTION LOBBY
- 81 RECEPTION LOBBY
- 82 RECEPTION LOBBY
- 83 RECEPTION LOBBY
- 84 RECEPTION LOBBY
- 85 RECEPTION LOBBY
- 86 RECEPTION LOBBY
- 87 RECEPTION LOBBY
- 88 RECEPTION LOBBY
- 89 RECEPTION LOBBY
- 90 RECEPTION LOBBY
- 91 RECEPTION LOBBY
- 92 RECEPTION LOBBY
- 93 RECEPTION LOBBY
- 94 RECEPTION LOBBY
- 95 RECEPTION LOBBY
- 96 RECEPTION LOBBY
- 97 RECEPTION LOBBY
- 98 RECEPTION LOBBY
- 99 RECEPTION LOBBY
- 100 RECEPTION LOBBY

BASEMENT PLAN

MAIN BUILDING
 RESEARCH AND EDUCATIONAL HOSPITALS OF THE STATE OF ILLINOIS, CHICAGO
 RICHARD E. SCHMIDT, GARDEN & MARTIN, ARCHITECTS

Hospital Construction as Affecting Distribution of Food*

IN a development of the construction plans of a hospital the variety of phases to be considered are infinitesimal, but there is no one phase more difficult of correlation, no one phase meaning more to the future economical and efficient operation of the hospital, than the proper planning of the dietary department. This has by far the largest individual budget of any department in the hospital, and inasmuch as the physical layout is responsible to a large extent for its efficient or inefficient performance, too much care cannot be given to the proper planning of this activity.

It must be borne in mind that the institutional feeding problem is a rather complex one, covering serving of food to private patients, to ward patients, and to the hospital personnel, necessitating a very careful consideration of the methods of service in conjunction with preparation. A very common mistake is that of planning the dietary department and then attempting to fit a service to this plan, rather than approaching the problem in the logical way, by first determining the character of service and then fitting the plan around that type of service.

The centralization of all preparatory service is of course by far the most economical, and if it is possible with the type of institution to prepare and serve the personnel of the institution from the main kitchen, it should be done. However, there are certain developments in which this is not possible.

The location of the main kitchen is of paramount importance. There are three general locations: the top floor, the first floor, or in a separate building.

There are some few types of hospital buildings that lend themselves to a top floor kitchen development, but the scheme in general should not be encouraged. The top floor of a building is unquestionably the best floor for patients, and unless there are some unusual conditions that make a portion of this floor available for kitchen purposes better than for patients, this location is not advocated. In addition is the problem of transportation of such supplies as coal, groceries, ice, etc., and returning garbage, ashes, etc. In favor of this location, of course, is the fact that the odor from such a kitchen is less objectionable; but after all, if a kitchen is properly ventilated, this nuisance can be reduced to a negligible quantity. In a small hospital, unquestionably the best location for the kitchen is on the first floor.

as near to the center of activities as possible, in order that the travel of food may be reduced to a minimum. The separate building for the large institution is very desirable, provided it can be properly correlated. Careful consideration must be given in any location to see that it will be possible to transport the food quickly and with a minimum loss of heat in transport.

Very little, if anything, can be said as to the size of the kitchen, this being dependent entirely upon the type of institution, the proportion of private to ward beds, etc. By all means, the size should be developed from a very thorough knowledge of the service to be performed, bearing in mind that unnecessary space necessitates unnecessary labor. If at all possible, and the desirability of making such a scheme possible is very great, the kitchen should be open on three sides. The ventilation of a kitchen suite is rather difficult at times. The efficiency of hoods, ranges, stock pots, etc., is a mooted question, and unless such a hood is supplemented by exhaust fans, both in the stack and in the hood, and in the openings in the kitchen proper, they are of very little value.

Too much attention cannot be given to this question of ventilation, nor the question of light. The walls should be of white tile if possible, not only for cleanliness' sake, but for the sake of better lighting.

The type of floor is important from a housekeeping point of view. Red quarry tile makes an exceptionally good floor. It is expensive, but the necessity for providing a floor that can be easily cleaned, and one that will wear well, indicates a very careful consideration of such a floor, or a floor of similar type.

For hospitals of one hundred beds or over, unquestionably there should be furnished separate pastry rooms, sculleries, meat and vegetables rooms, and cold and dry storage. With large units, additional rooms are indicated. The policy of having one room for the entire kitchen activity tends to confusion and is not productive of the best results.

By far more important than the actual equipment is its proper installation. A very efficient piece of equipment may lose its entire value if placed relatively in the wrong position in the activity. The whole kitchen operation should be studied with an institutional performance in mind, laying out the unit to permit the easiest possible performance. Hotel installation is not a good example to follow.

*Extract of an address read by Frank E. Chapman, superintendent of Mount Sinai Hospital, Cleveland, before the Twenty-second Annual Convention of the American Hospital Association in Montreal.

INDEX

- 1 BELL ROOM
- 2 BELL ROOM
- 3 BELL ROOM
- 4 BELL ROOM
- 5 BELL ROOM
- 6 BELL ROOM
- 7 BELL ROOM
- 8 BELL ROOM
- 9 BELL ROOM
- 10 BELL ROOM
- 11 BELL ROOM
- 12 BELL ROOM
- 13 BELL ROOM
- 14 BELL ROOM
- 15 BELL ROOM
- 16 BELL ROOM
- 17 BELL ROOM
- 18 BELL ROOM
- 19 BELL ROOM
- 20 BELL ROOM
- 21 BELL ROOM
- 22 BELL ROOM
- 23 BELL ROOM
- 24 BELL ROOM
- 25 BELL ROOM
- 26 BELL ROOM
- 27 BELL ROOM
- 28 BELL ROOM
- 29 BELL ROOM
- 30 BELL ROOM
- 31 BELL ROOM
- 32 BELL ROOM
- 33 BELL ROOM
- 34 BELL ROOM
- 35 BELL ROOM
- 36 BELL ROOM
- 37 BELL ROOM
- 38 BELL ROOM
- 39 BELL ROOM
- 40 BELL ROOM
- 41 BELL ROOM
- 42 BELL ROOM
- 43 BELL ROOM
- 44 BELL ROOM
- 45 BELL ROOM
- 46 BELL ROOM
- 47 BELL ROOM
- 48 BELL ROOM
- 49 BELL ROOM
- 50 BELL ROOM
- 51 BELL ROOM
- 52 BELL ROOM
- 53 BELL ROOM
- 54 BELL ROOM
- 55 BELL ROOM
- 56 BELL ROOM
- 57 BELL ROOM
- 58 BELL ROOM
- 59 BELL ROOM
- 60 BELL ROOM
- 61 BELL ROOM
- 62 BELL ROOM
- 63 BELL ROOM
- 64 BELL ROOM
- 65 BELL ROOM
- 66 BELL ROOM
- 67 BELL ROOM
- 68 BELL ROOM
- 69 BELL ROOM
- 70 BELL ROOM
- 71 BELL ROOM
- 72 BELL ROOM
- 73 BELL ROOM
- 74 BELL ROOM
- 75 BELL ROOM
- 76 BELL ROOM
- 77 BELL ROOM
- 78 BELL ROOM
- 79 BELL ROOM
- 80 BELL ROOM
- 81 BELL ROOM
- 82 BELL ROOM
- 83 BELL ROOM
- 84 BELL ROOM
- 85 BELL ROOM
- 86 BELL ROOM
- 87 BELL ROOM
- 88 BELL ROOM
- 89 BELL ROOM
- 90 BELL ROOM
- 91 BELL ROOM
- 92 BELL ROOM
- 93 BELL ROOM
- 94 BELL ROOM
- 95 BELL ROOM
- 96 BELL ROOM
- 97 BELL ROOM
- 98 BELL ROOM
- 99 BELL ROOM
- 100 BELL ROOM

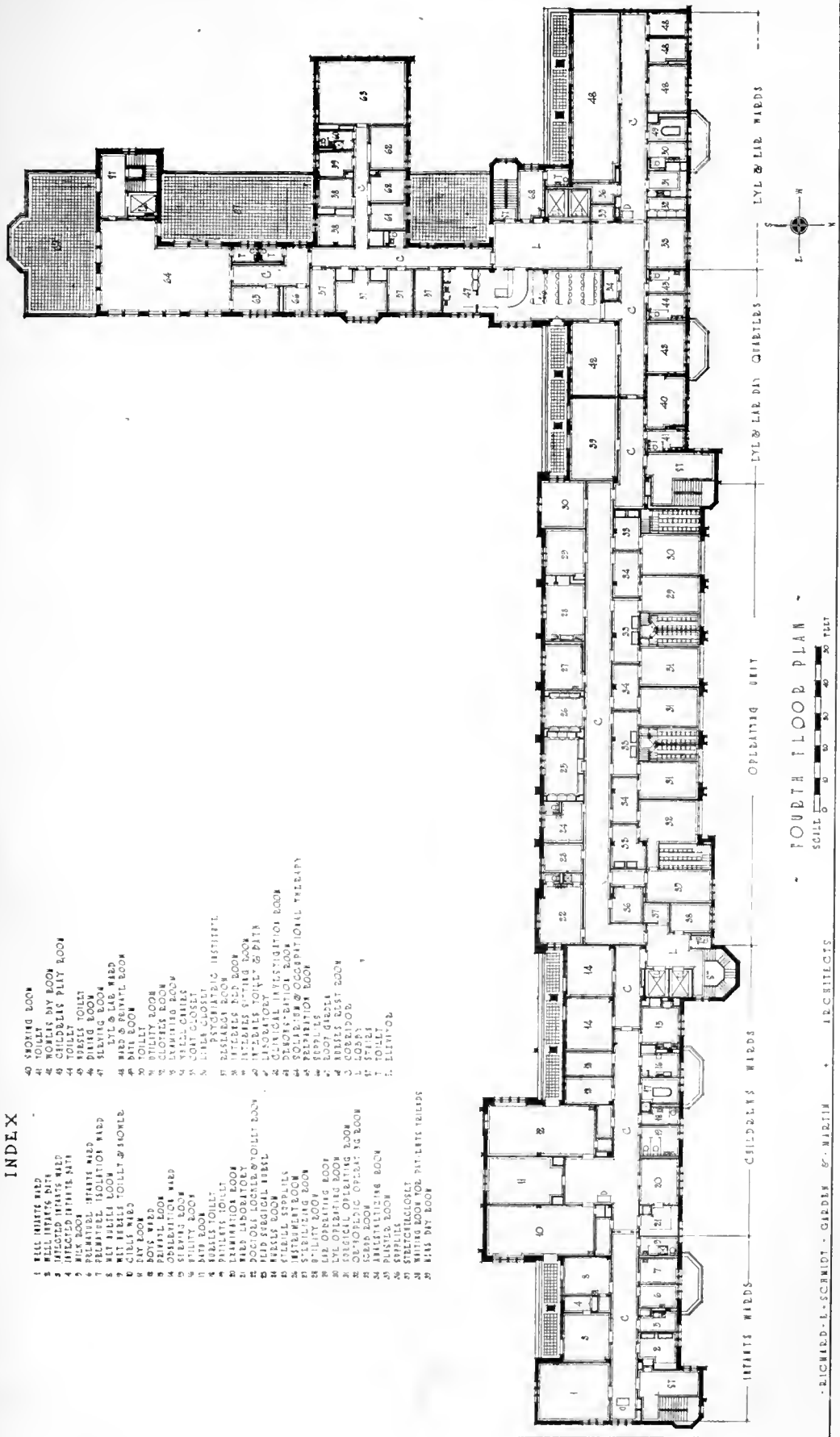

FOURTH FLOOR PLAN

MAIN BUILDING
 RESEARCH AND EDUCATIONAL HOSPITALS OF THE STATE OF ILLINOIS, CHICAGO
 RICHARD E. SCHMIDT, GARDEN & MARTIN, ARCHITECTS

THE AMERICAN ARCHITECT

The service required of a hotel kitchen is entirely different than that required of a hospital kitchen.

The installation of hoods over as much of the equipment as is possible is very desirable. This not only takes off odors, but has a very salutary effect on the temperature of the room, provided these hoods are properly connected up.

Too much emphasis cannot be placed on the installation of as many labor saving devices as possible. These not only conserve labor, but they insure economy in the distribution of foodstuffs.

The item of plumbing in the kitchen is a very important one. Care should be exercised to get sinks at the proper height from the floor, in order that the preparation of vegetables and washing of pots and pans may be done with the minimum of expended energy.

The question of open shelves or closed cupboards is a matter of personal preference. In any event, these cupboards or shelves should be adequate in capacity and easy of access.

The elevator service should be given very careful consideration. It is highly undesirable that foodstuffs be handled on the regular passenger elevators. By all means, electric dumb waiters should be installed, if dumb waiters are indicated. The personnel should not be compelled to labor with the hand operated system. Dumb waiters as usually installed are not sufficiently large to accommodate food carts. If food cart service is to be used as a routine, care should be taken to see that elevator service adequate to take care of these carts is installed in duplicate, in order to insure a continuity of service.

The special diet kitchen should definitely be a part of the kitchen activity and should be so located as to permit of easy supervision on the part of the dietitian. The same comments pertain as in the main kitchen. This room should be sufficiently large to permit of an efficient operation, depending entirely upon the type of service and the size of the institution. It should be equipped with stove, broilers, dish warmers, sinks, and cupboards. It would also seem, in an institution in which a large number of infant feedings are prepared, that facilities should be provided for a room which can be used for the preparation of special formulas. Such a room need not be very large, but should be so constructed as to be easily cleaned and ventilated.

The ward serving room is a very important unit in the dietary service, and should be given very careful consideration in planning. Its location should be near the center of the unit that it serves, in order to reduce to a minimum the amount of effort necessary to serve trays. It should be planned so that the elevator service should either come directly into this room or be very closely adjacent

thereto. The flooring should be of a type that is easily kept clean and is non-absorbent. A fair size for a room of this character should be ten square feet per patient to be served, with a minimum of 150 feet floor space. The necessary equipment in such a room should include a refrigerator, a dish sterilizer for contaminated dishes, dish warmer, toaster, sink (double sink advocated), garbage receptacle, towel racks, cupboards, a tray rack of sufficient capacity to hold all the trays to be served, and a large work table with drawers.

The feeding of hospital personnel is an exceedingly difficult problem, and one that requires very close study to be satisfactorily worked out. In all events, the dining and service room should be located away from that part of the hospital containing patients, and should be varied in size and character, in order to serve the various classes of hospital attachés. As a minimum list of the types of dining rooms, the following is submitted: officers, interns, nurses, special nurses, office attachés, orderlies, domestic help.

A great many institutions have adopted the cafeteria method of service. While it is true that this is economical, and offers some very definite advantages over maid service, it is questionable if it is a desirable service. The hospital dining room is one of the few places of relaxation for the personnel of the institution. Most of these people have no other home than the hospital, and certainly standing in line for three meals a day, 365 days a year, has not the tendency of creating the homelike atmosphere that is desirable in a hospital. In any event, the location and equipment of serving rooms is dependent primarily upon the type of service that is to be rendered. If there is cafeteria service, the arrangement of commercial cafeterias may be copied, bearing in mind, however, that there will have to be at least two, and probably three, different serving rooms to take care of the various classes of attachés. It is extremely undesirable, in fact almost impossible from an administrative standpoint, to have all groups supplied from one serving room.

Food may be conveyed to patients by several methods: It may be taken by heated food carts, heated by hot water jackets or by electrical elements. This method is in very common usage. Such a cart has some very definite advantages; but it has one distinct disadvantage, *i. e.*, unless the food is handled very promptly, the injection of this additional heat in transit has a tendency to change the character of food by cooking it over and above the palatable state. This equipment does not, however, provide for the handling of cold foods, such as salads, desserts, etc. A new device on the market

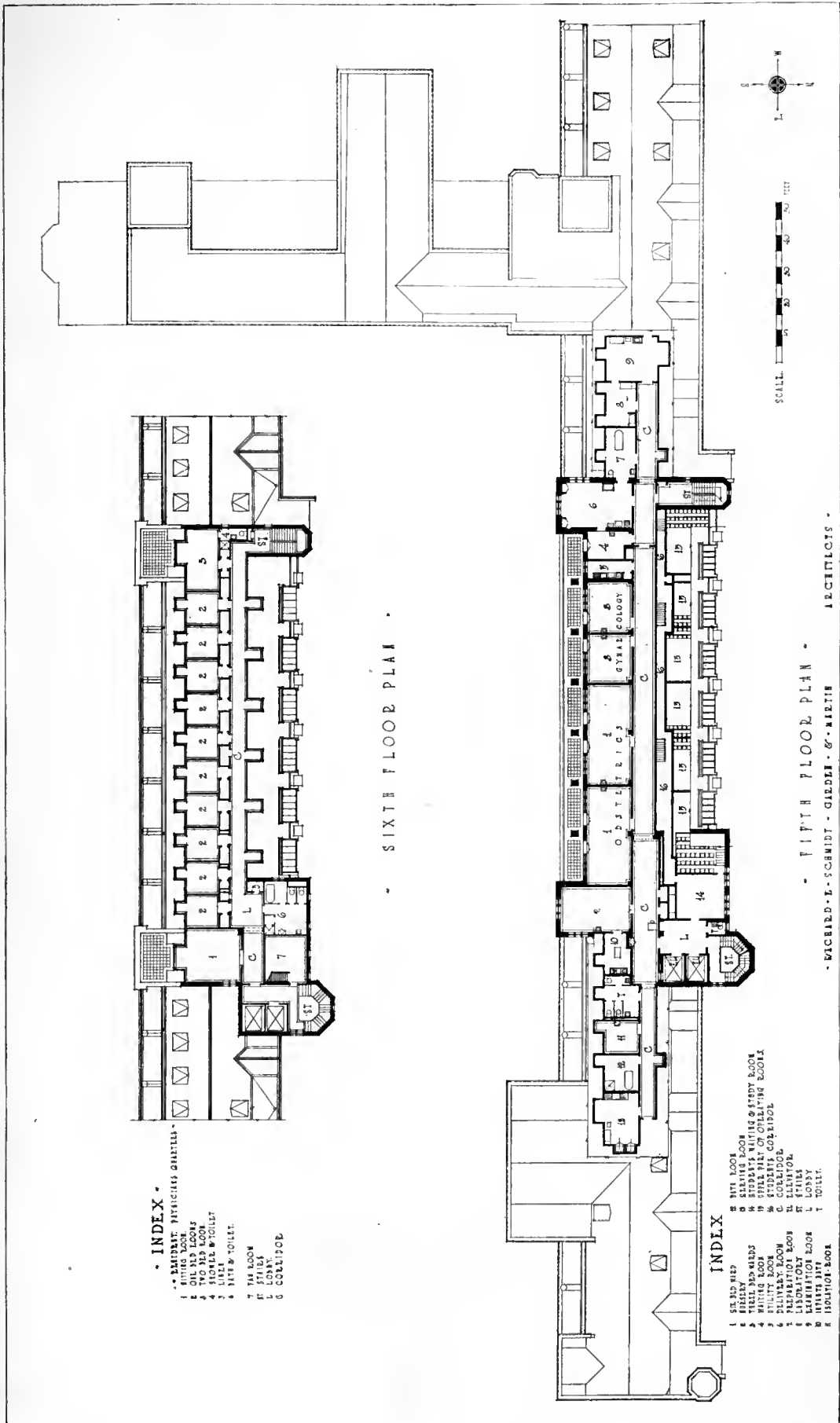

- INDEX**
- 1. HALLWAY - PHYSICIAN'S OFFICES
 - 2. OFFICE
 - 3. TWO BED ROOMS
 - 4. SINGLE BED ROOM
 - 5. HALLWAY
 - 6. BATH & TOILET
 - 7. THE ROOM
 - 8. LOBBY
 - 9. COLLECTOR

SIXTH FLOOR PLAN

- INDEX**
- 1. STAIRS
 - 2. HALLWAY
 - 3. THE ROOM
 - 4. HALLWAY
 - 5. HALLWAY
 - 6. HALLWAY
 - 7. HALLWAY
 - 8. HALLWAY
 - 9. HALLWAY
 - 10. HALLWAY
 - 11. HALLWAY
 - 12. HALLWAY
 - 13. HALLWAY
 - 14. HALLWAY
 - 15. HALLWAY
 - 16. HALLWAY
 - 17. HALLWAY
 - 18. HALLWAY
 - 19. HALLWAY
 - 20. HALLWAY
 - 21. HALLWAY
 - 22. HALLWAY
 - 23. HALLWAY
 - 24. HALLWAY
 - 25. HALLWAY
 - 26. HALLWAY
 - 27. HALLWAY
 - 28. HALLWAY
 - 29. HALLWAY
 - 30. HALLWAY
 - 31. HALLWAY
 - 32. HALLWAY
 - 33. HALLWAY
 - 34. HALLWAY
 - 35. HALLWAY
 - 36. HALLWAY
 - 37. HALLWAY
 - 38. HALLWAY
 - 39. HALLWAY
 - 40. HALLWAY
 - 41. HALLWAY
 - 42. HALLWAY
 - 43. HALLWAY
 - 44. HALLWAY
 - 45. HALLWAY
 - 46. HALLWAY
 - 47. HALLWAY
 - 48. HALLWAY
 - 49. HALLWAY
 - 50. HALLWAY
 - 51. HALLWAY
 - 52. HALLWAY
 - 53. HALLWAY
 - 54. HALLWAY
 - 55. HALLWAY
 - 56. HALLWAY
 - 57. HALLWAY
 - 58. HALLWAY
 - 59. HALLWAY
 - 60. HALLWAY
 - 61. HALLWAY
 - 62. HALLWAY
 - 63. HALLWAY
 - 64. HALLWAY
 - 65. HALLWAY
 - 66. HALLWAY
 - 67. HALLWAY
 - 68. HALLWAY
 - 69. HALLWAY
 - 70. HALLWAY
 - 71. HALLWAY
 - 72. HALLWAY
 - 73. HALLWAY
 - 74. HALLWAY
 - 75. HALLWAY
 - 76. HALLWAY
 - 77. HALLWAY
 - 78. HALLWAY
 - 79. HALLWAY
 - 80. HALLWAY
 - 81. HALLWAY
 - 82. HALLWAY
 - 83. HALLWAY
 - 84. HALLWAY
 - 85. HALLWAY
 - 86. HALLWAY
 - 87. HALLWAY
 - 88. HALLWAY
 - 89. HALLWAY
 - 90. HALLWAY
 - 91. HALLWAY
 - 92. HALLWAY
 - 93. HALLWAY
 - 94. HALLWAY
 - 95. HALLWAY
 - 96. HALLWAY
 - 97. HALLWAY
 - 98. HALLWAY
 - 99. HALLWAY
 - 100. HALLWAY

SCALE 1" = 20'



RESEARCH AND EDUCATIONAL HOSPITALS OF THE STATE OF ILLINOIS, CHICAGO
 RICHARD E. SCHMIDT, GARDEN & MARTIN, ARCHITECTS

is a food cart constructed on the principle of the fireless cooker or vacuum bottle. The most perishable of foodstuffs placed in this cart will retain its character and heat for several hours. This equipment, from personal experience, is submitted as the most efficient method of transporting foodstuffs.

In conclusion, there is one primary thought that it is desired to convey. The best of raw material improperly prepared and improperly served is rank extravagance. If it cannot be placed before the patient in a condition to be eaten, it might better not

have been cooked. The great trouble with hospital dietaries is that foodstuffs are primarily prepared with facilities that have not been planned for the service; and as a consequence the food is handled so many times that it is bound to be cold when served. In the planning of a hospital building, the importance of the dietary department should not be overlooked. It should be studied just as carefully as one would study the location and equipment of the operating room suite, and the results obtained will more than justify the efforts.

The Case for Modern Architecture

From an Address by JOHN W. SIMPSON, P.R.I.B.A.

TRADITIONAL education in design during the second half of the nineteenth century was disturbed—one might say bewildered—by a deluge of illustrated books and periodicals due to improved and cheapened processes of photography. The student, instead of having to select and make his own drawings of a chosen subject, thus found at his disposal a heterogeneous mass of information about buildings in every country and style. Though incomplete—presenting selected aspects only, of compositions which need plan, elevation and section to reveal their true meaning; and prone to emphasize the picturesque, rather than the greater qualities of our art—the material supplied was for the most part good of its kind, and we owe to photography many really valuable works of reference. The trouble was not so much the quality as the sudden profusion of varied suggestions, confusing to the receptive mind, overtaxing its capacity for absorption and digestion. In effect we have lived through an age which has collected a vast deal of new knowledge, some superficial, but on the whole profitable. Our fathers hardly strayed outside the classic groves of Greece and Rome, save for excursions into the field of Italian Renaissance, a passing glance at its French manifestation, and perhaps a somewhat inappreciative survey of the Gothic cathedrals. We, cheaper and easier travel abetting, have had spread before us an architectural panorama of the whole world through seven thousand years of time. Egypt, Crete, China, Japan, Mexico, India, to say nothing of Spain and the less-visited parts of Europe. The result may, or may not, be something unexpected, but we see already a wider view prevailing of what constitutes tradition, a shedding of prejudice and much experimental reproduction of exotic work; tentative efforts to find seemly clothing for new needs, to which neither toga, trunk hose nor periwig can be suitably adapted.

These "new needs" form perhaps the chief reason for the change from what was deemed traditional design. Educational and commercial requirements, for example, have altered materially since our boyhood, and have to be frankly recognized and provided for.

Incompetent criticism, like any other public duty ill performed, has evil results. Persistent depreciation of contemporary and recent art is, in great measure, responsible for revolutionary efforts to break away altogether from the past, to find a new and short road to æsthetic expression. Exasperated by incessant taunts, unbalanced minds are stampeded from the quiet fields of honest study into the frantic eccentricities which, now and again, astonish us—and vanish into oblivion. The classic track is no easy one, they are told it leads nowhere, and lack the faith to follow it to fruition. Architecture has been perhaps less disturbed by the clamour than has sister arts; its solid ballast of utility has steadied it; but architects, too, are disquieted by demands for originality, for a "national style," by assertions that "the old was better," by accusations of being mere copyists. We need not take the outcry too seriously. The middle period of the nineteenth century is still the common quarry of æsthetic hawks, but the work of its earlier years is now discovered to be better than was supposed; Gower street, built in 1826, is no longer the type of the unlovely. Let us hear what Heine, an accomplished critic and admirer of London, who was here at the time, thought of its architecture. "These houses of brick," he writes in his *English Fragments*, "become of a uniform brown color; they are all of the same style of building, generally two or three windows wide, three stories high, with small red tiles above which remind one of newly extracted, bleeding teeth; the broad and accurately aligned streets seem to be bordered by endlessly long barracks. Rich speculators, to meet

(Concluded on page 243)



THE PSYCHIATRIC WING VIEWED FROM THE SOUTHWEST
RESEARCH AND EDUCATIONAL HOSPITALS OF THE STATE OF ILLINOIS, CHICAGO
RICHARD E. SCHMIDT, GARDEN & MARTIN, ARCHITECTS

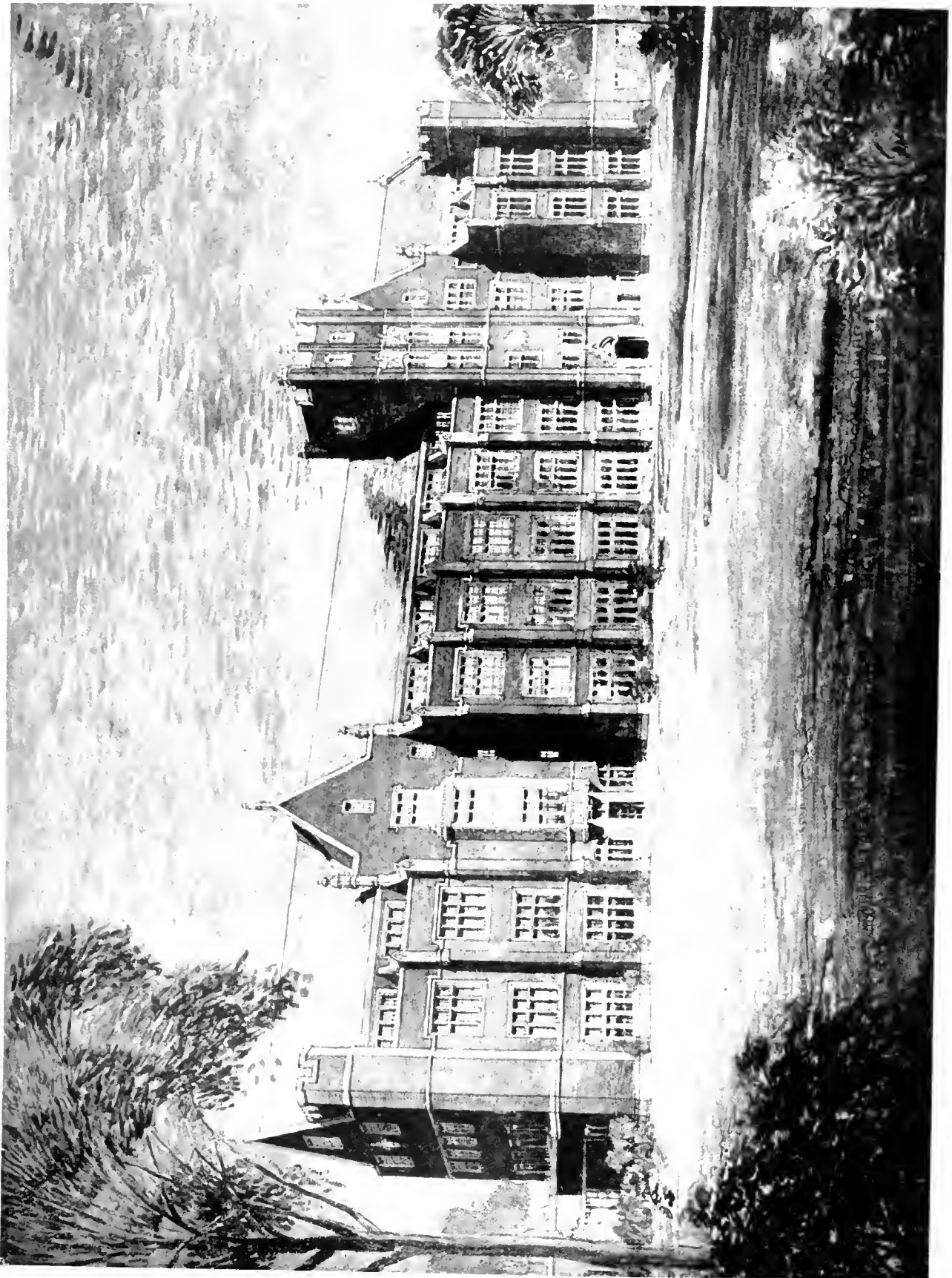

ORTHOPEDIC HOSPITAL AS SEEN FROM THE QUADRANGLE
RESEARCH AND EDUCATIONAL HOSPITALS OF THE STATE OF ILLINOIS, CHICAGO
RICHARD E. SCHMIDT, GARDEN & MARTIN, ARCHITECTS

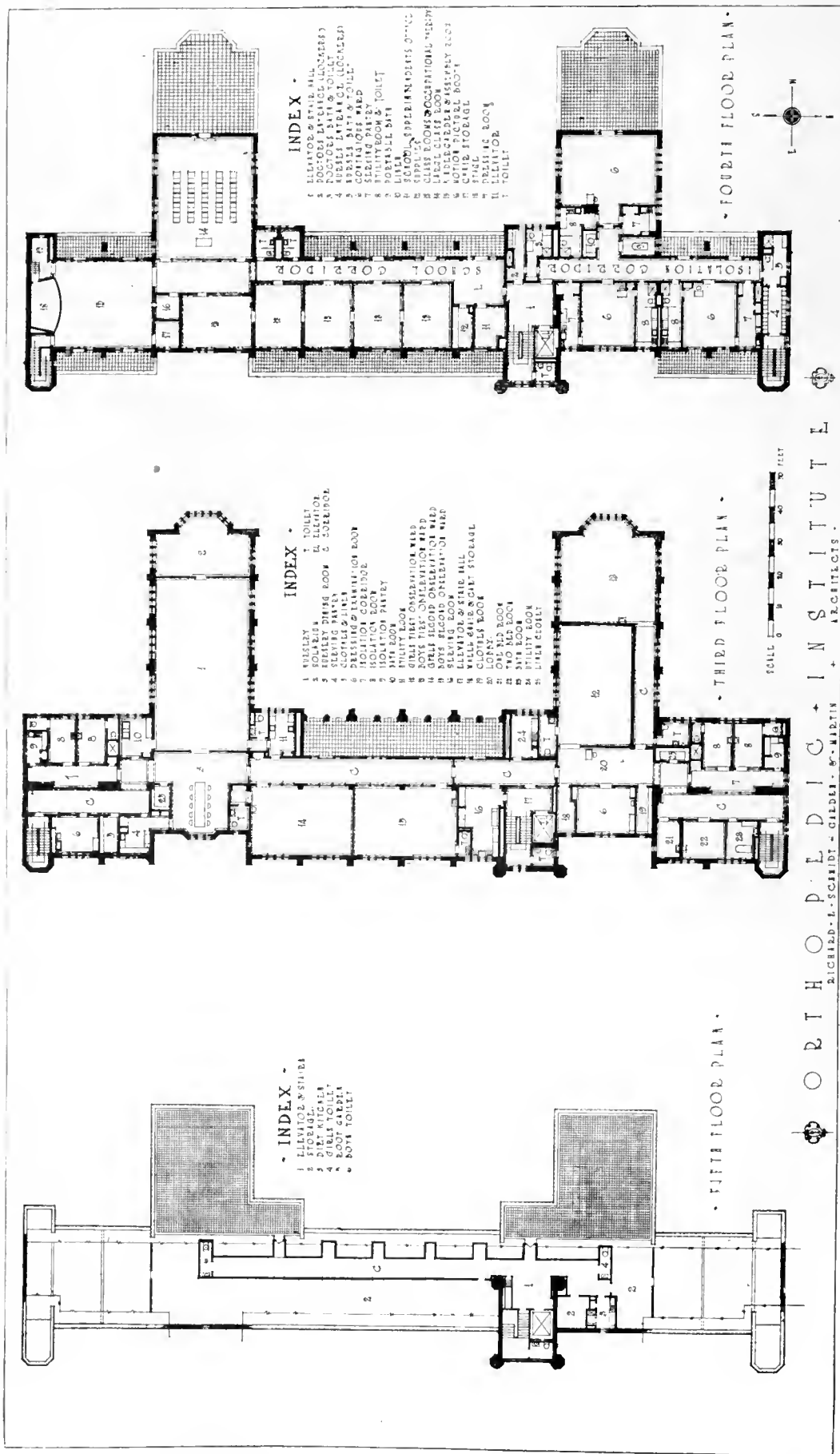

ORTHOPEDIC INSTITUTE
 RICHARD E. SCHMIDT - GILLES - & MARTIN ARCHITECTS
 RESEARCH AND EDUCATIONAL HOSPITALS OF THE STATE OF ILLINOIS, CHICAGO
 RICHARD E. SCHMIDT, GARDEN & MARTIN, ARCHITECTS

The Case for Modern Architecture

(Continued from page 238)

the demand, build wholesale entire streets of these dwellings, which they retail singly. At the west end, where the more aristocratic and less-occupied world lives, this uniformity is still more dominant; here there are very long and broad streets, where all the houses are as large as palaces, outwardly anything but distinguished, unless we except the fact that in these, as in all the better class of houses in London, the windows of the first story are adorned with iron-barred balconies, and on the ground floor there is also a black railing, protecting the entrance to certain cellar apartments buried in the earth. In this part of the city are also great squares, where rows of houses, like those already described, form a quadrangle."

It is no new thing, this eulogy of the past and disparagement of the present. We may doubt if any artist is justly appreciated till long after he is beyond the reach of praise or blame; some may be overrated, others are certainly underrated, "the idols of past generations crumble suddenly to dust, while the despised and rejected are lifted to pinnacles of glory." This is most true of architecture, for it is the mirror of our own life, and the reflection is too clear to be flattering.

My address must necessarily, I fear, be deemed illogical. An artist must be convinced of the rightness of his work, for without faith is no enthusiasm; a doubter can never achieve a great creation. If, then, he can so detach himself from conviction as to be able to compare the work of dead Masters with his own, to survey dispassionately the past and present, he is no artist, and has no more claim to attention than the casual layman! The syllogism is irresistible; I offer you my thoughts; you will form your own conclusions. For my part, I shall prudently evade the consequence of the argument and make no reference to the work of living men.

In determining the merit of modern architectural work there are certain actualities to be taken into account, if we are to arrive at a true judgment. To these, as it seems to me, sufficient attention is not given by those—whether technicians or lay writers—who attempt to define the quality of recent design in relation to the standards bequeathed by the great ancestors of our calling.

As for "national style," whether it be good or bad, it clearly exists. No one could mistake a British city for one of any other country; our national signature is written all over it. It is nevertheless possible that we are on the verge of such a new departure in

our art as has taken place in the art of warfare, where "fighting," in the historic sense, with the development of guns and swords, seems likely to give place to mere destruction by misuse of the products of peaceful industries. In our case it may well come about by frank recognition of the qualities of the machine, as opposed to obsolete methods of hand work. There is nothing inherently uncongenial in the association of machine work with architecture; the real incongruity is in attempts to maintain, or revive, mediæval craftsmanship in the twentieth century. Its charm lay in its spontaneity, its unaffected fitness for the surroundings of its date; to imitate it is to fabricate artificial flowers, which lack life and perfume. We live in an age of machines, and true architecture must needs reflect their influence. If we set ourselves to the planning and constructing of buildings supremely proper for their purpose, art will take care of itself. An artist will always solve his problem artistically. Finding inspiration in stern Utility, he transmutes it by his touch into

"Some fragment from his dream of human life,
Shaped by himself. . . ."

The question of "originality" is bound up with that of comparison. Ecclesiastes, you will remember, pointed out that "The thing which hath been, it is that which shall be; and that which is done is that which shall be done; and there is no new thing under the sun. Is there anything," he asks, "whereof it may be said, See, this is new? it hath been already of old time which was before us." In this sense, originality is, of course, impossible; on the other hand, the permutations and combinations of the eternal elements of architecture are beyond number, and I take the demand for original design to mean no more than for a fresh disposition of walls, doors, windows, roofs, their proportions and decorations. Here arises a curious point in support of the words of Solomon, who, you will also remember, "praised the dead which are already dead more than the living which are yet alive," for quite other reasons than those of our critics. If a building could be imagined which should be wholly original in design, neither its merit nor its demerit could be appreciated by the human mind. It would speak an unknown tongue; and there would be no standard by which to compare it. It follows that in every design must be repeated some known forms or features whereby we may interpret and recognize the composition. Here is the reason why old work, the masterpieces of antiquity, must be studied with assiduous care and exactitude, lest our knowledge of them be imperfect, and tradition debased by inferior reproduction.

Old Tavern, Rossville, Staten Island

(See reproduction of original drawing by O. R. Eggers on opposite page)

Stage coach and tavern days were picturesque ones during our Colonial period. With our present facilities for safe and quick journeys over long distances it is difficult to realize with what trepidation and great preparation our forefathers set about the trip from Philadelphia to Boston.

Now a matter of hours, then a journey of weeks, the venturesome traveller, we learn, was wont to make his will, set his house in order and bid his family a tearful good-bye. It was only the rich and important who could afford the expense of these long stage coach trips and it is for this reason that these taverns are in a sense historical landmarks.

At one time or another they have sheltered the great men who were active during our Colonial period.

The tavern at Rossville on Staten Island, picturesquely presented by Mr. Eggers' skillful pencil, is on the one time direct route between the southern and northern colonies. It was along this route that Washington journeyed when he set out for New York to take the oath of office as first President of the United States.

In its architecture the tavern at Rossville follows traditions of Dutch Colonial types. In fact it may be regarded as an excellent example of that period. Much of the picturesqueness of Staten Island has now disappeared and this old tavern is but a suggestion of what it was when all the village turned out to greet the arrival of "The Coach" and stare open-mouthed at the passengers alighting to stretch their legs after the long run from Trenton to find in the low-ceilinged tap room the refreshment that would ease their fatigue and fortify them to continue their journey.

244 a



OLD TAVERN, ROSSVILLE, STATEN ISLAND, N. Y.
THE AMERICAN ARCHITECT Series of Early American Architecture

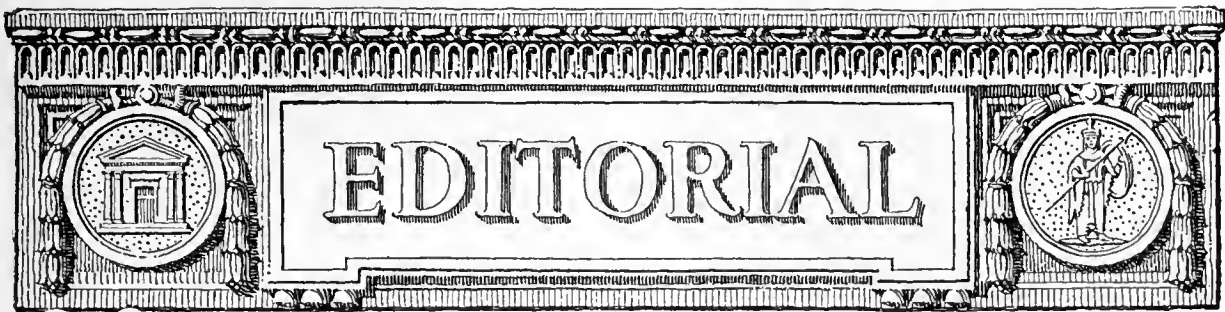

Improving Farm Conditions

CONSIDERABLE space has been given in these pages during the past three years urging on the agricultural departments of the various states the necessity for action looking toward the betterment of the architectural aspect of farm buildings and the conditions surrounding the life of agricultural workers.

It is gratifying to note that this important matter is being seriously considered by the Department of Agriculture in Washington and that the offer of cooperation on the part of the American Institute of Architects has been promptly accepted. Through its various chapters in the agricultural states, the Institute will be able to afford the government the most valuable assistance and if the subject is kept alive we may early look for a decided improvement in the types of farm building and the consequent betterment of the social conditions affecting farm life.

While most of the argument advanced as to the betterment of farm buildings has been to persuade men either to stay on the farm or to return to farm life, it must not be forgotten that the farm will be no lodestone for men unless it is also for women. A farm home survey recently made by the Department of Agriculture shows why it is not attractive to women.

More than 10,000 farm houses in thirty-three states were surveyed. The working day of farm women was found to average 11.3 hours the year round. These long hours were due to the lack of ordinary facilities and the poor equipment and planning of the houses. What is needed to make the farm attractive is that its houses and their equipment shall more nearly approach those in town. The development of trolley systems and of motor transit has enabled the farm worker to become more closely associated with town life. The comparison they make is all against the farm. We shall not be able

to effect the desired result until we have made the home surroundings of the farmer attractive.

A National Archives Building

A BILL recently introduced by Senator Smoot, prohibiting smoking in public buildings but touches the rim of an important matter, a deplorable condition to which this journal has many times directed attention. During the last two months, fire has destroyed one state capitol and has done \$2,000,000 worth of damage in the Census Bureau.

It is small wonder that the State Department should show uneasiness over the possible loss that would occur in the State, War and Navy Building in the event of a fire. In addition to the valuable and irreplaceable documents stored in this building, there rest in a safe which in the judgment of the National Board of Fire Underwriters would not stand a severe fire, the original copies of the Declaration of Independence and the Constitution of the United States. If by any chance fire should destroy these, the loss would of course be irreparable and this country would stand before the world as recreant to a solemn duty.

In 1914 Congress passed an act authorizing the construction of a fire-proof Archives Building, where the invaluable records of the various departments not only might be stored secure from destruction by fire and water, but where they could be scientifically arranged and made available for the use of those to whom their use is valuable. Notwithstanding that authorization, however, under which the Government was empowered to acquire the property and to construct the building, and notwithstanding the fact that a preliminary appropriation for the drawing of plans has been made by Congress, and that the necessary appropriation has been estimated for by the Secretary of the Treasury from year to year, Congress has failed to make the appropriation.

Patriotic people in this country will feel easier in mind when Congress acts in this important matter.

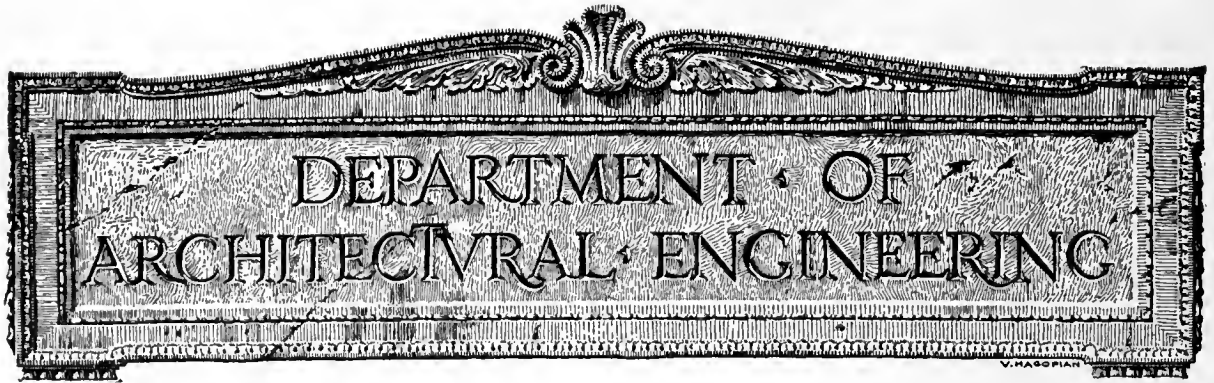

The Correct Application of Metal Lath to Avoid Plaster Cracks

Results of Tests Recently Conducted at Armour Institute, Showing Best Forms of Application

As the name indicates metal lath is a metal support or background for plaster or stucco work. Rapid developments in the application and use of metal lath in building construction have been made in recent years and now we find it successfully used in the highest grade buildings. The uses of metal lath are not confined to plaster and stucco work for we find it in many other parts of building construction, such as reinforcement for concrete work. This article, however, will deal with it only as it is used as an improved substitute for wood lath and will call particular attention to recent tests conducted at Armour Institute of Technology by G. F. Gebhardt and J. C. Peebles, for the purpose of determining the best method of application of metal lath to prevent cracks in plaster walls and ceilings.

In thinking of the results of these tests, let us remember that the purpose of metal lath is for a support for the plaster and not to give any rigidity to the frame-work itself. Many cases will show that

where the lath and plaster have been properly applied, a certain amount of rigidity was obtained, but the deflection and failure of the framework under load have nothing to do with the efficiency of metal lath. It is surprising to note, however, that

cracks did not appear in metal lath and plaster walls (properly applied) until after the frame work failed, which means that all deflections caused by loads for which the frame was designed will not cause cracks in this type of construction. It is only when overloaded to



SAMPLE B-1



SAMPLE B-X

Crack developed in center of wall and stopped when it reached the corner

to the point of failure that the cracks will appear.

The fact that expanded and sheet metal lath have enjoyed a greatly increased market in spite of keen competition indicates that it must have many practical advantages. It simplifies construction, is easily and quickly handled and erected, provides better reinforcement for plaster and when properly applied, prevents plaster cracking better than any other lathing.

The results of the tests showed that metal lath should be applied to the ceilings and carried down 6 in. on all walls and partitions. It should not be permitted to butt together in the corners, but should

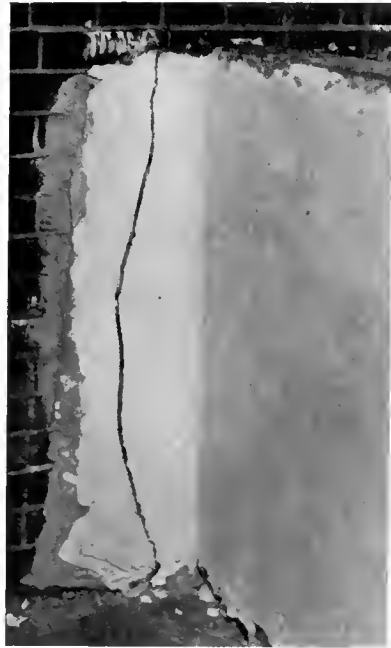

SAMPLE C-2

With cornerite—corner crack developed at deflection greater than maximum allowable

be started one stud away and bent into the corner to avoid a lap there. On walls and partitions, metal lath should be started at the top and carried down, allowing the lower sheets to lap over the upper sheets not less than one-half inch. On the sides the sheets should be lapped not less than 1/2 in. and tied once with wire between the supports. When channels are spaced on 15 1/4 in. centers No. 18 gauge black

annealed iron tie wire should be used once between supports. No tie wire is necessary when the sheets are lapped 1/2 in. and nailed or stapled to wood studs spaced on 16-in. centers.

These tests were run in eight series, each series investigating different points of weakness under different forms of construction. Series A, dealing with cracks where side wall and ceiling meet, appeared in THE AMERICAN ARCHITECT, February 16, 1921.

SERIES B—CORNER WHERE TWO PARTITION WALLS MEET.

1. Two wood lath partition walls @ 90°; 6" metal lath bent into corner and attached at edges only.
- X. Same as 1, except metal lath lap in corner is omitted.
2. Same as 1, but with 6" metal lath strip, 3" on each partition wall.
3. Same as 1, except metal lath lap is attached at both edges and corner.

The test pieces in Series B consisted of two 34" x 36" partition walls, meeting at 90 degrees. The studs were 2" x 4" hemlock spaced on 16" centers.

In the testing machine one wall was securely supported from below in a vertical position. The other wall was unsupported and the load was so applied to parallel the condition that maintains when one wall settles and the other remains fixed.

The results of this test were interesting because they showed that where metal lath lap was provided in the corner, the crack developed first in the central wall and in nearly every case was stopped when it reached the corner. It was almost impossible to produce a corner crack. Sample Bx had no lap and corner cracks developed.

SERIES C — SAME AS B EXCEPT ONE WALL IS MASONRY.

1. Wood lath butting into masonry; cornerite attached at edges only.
2. Same as 1, but with cornerite attached at edges only.
3. Same as 1, without cornerite.
4. Metal lath butting into masonry wall with 6" lap.
5. Same as 4 without cornerite.
6. Same as 4 except metal lath lapped 3" on masonry wall instead of 6".

The samples were attached to the interior side of a permanent masonry wall

and plastering was carried approximately 12 in. on the masonry wall to provide for a good corner.

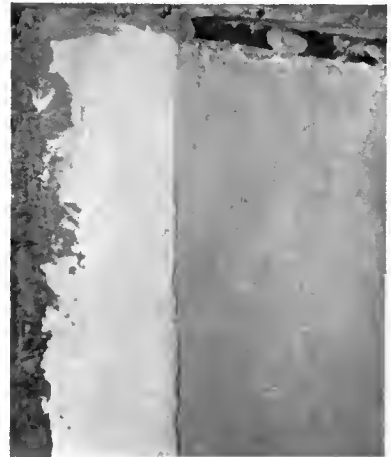

SAMPLE C-3

No cornerite—corner crack developed at deflection less than maximum allowable



SAMPLE C-5

No cornerite—see note Sample C-3



SAMPLE C-6

With cornerite—see note Sample C-2

THE AMERICAN ARCHITECT

A lifting force was applied to the partition wall giving the same effect as if the masonry wall settled.

The following table shows the upward movement of outer edge of partition wall at which corner crack first appeared, and the numerical order of this crack among all cracks occurring.

Sample	Upward Movement of Outer End of Partition Wall —Inches	Numerical Order of Corner Cracks
C1	0.51	1
C2	0.19	1
C3	0.05	1
C4	0.54	1
C5	0.12	1
C6	No corner crack produced.	

which is equivalent to 2.256 inches at the center of a 16-ft. joist. This is far in excess of the maximum allowable deflection in such a joist, which is $1/360$ of the span, or 0.533 inch. The same disturbance would follow the vertical settlement of a wall or support 8 feet away from the corner.

Rather interesting observations may be made from this series of tests. It will be noted that both the metal lath and the wood lath without cornerite, samples C3 and C5, show a corner crack at a deflection reduced to a 16 ft. span, which is less than the allowable maximum noted above.

On the other hand, all samples reinforced with cornerite showed no corner crack until the deflection, expressed as above, exceeded the allowable maximum. Even the wood lath, the weakest of the cor-

Effect of Tie Wire and Lap in Reducing Deflection of Lath under Trowel.
Showing tie wire not needed on wood studs.

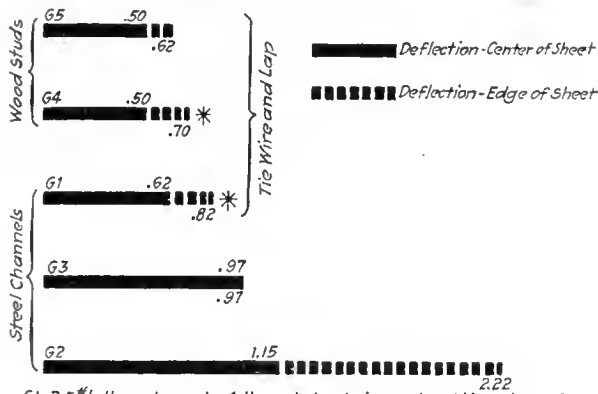

- G1-2.5" lath on channels-Adjacent sheets lapped and tied with 1 wire.
- G2-Same-No tie wire
- G3-Same-Laced channel to channel
- G4-2.5" lath on wood studs-No tie wire
- G5-Same-One tie wire midway between studs.
- * Assoc. Metal Lath Mfrs. Specifications

Showing that cornerite prevents corner cracks between partitions and masonry walls even after maximum allowable deflection is reached in joists.

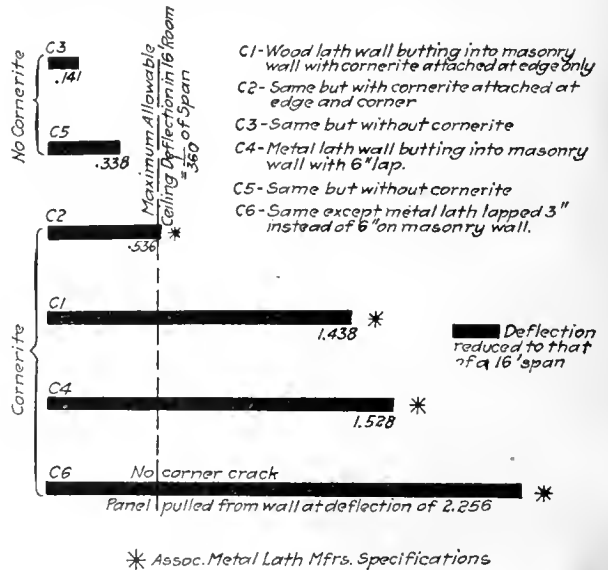

- C1-Wood lath wall butting into masonry wall with cornerite attached at edge only
- C2-Same but with cornerite attached at edge and corner
- C3-Same but without cornerite
- C4-Metal lath wall butting into masonry wall with 6" lap.
- C5-Same but without cornerite
- C6-Same except metal lath lapped 3" instead of 6" on masonry wall.

* Assoc. Metal Lath Mfrs. Specifications

The samples without cornerite were much less able to withstand cracking in the corner than those with cornerite and the metal lath wall with 6" lap showed the maximum distortion before corner crack appeared. The wall with 3" lap also showed excellent results, no corner crack appearing, but lath and plaster being stripped from brick wall instead.

Under the test conditions which were as near practical conditions as it is possible to come, the metal lath wall with lap on brick wall, is the strongest to resist corner cracking, while wood walls without cornerite are the weakest.

On the wood wall, the better result was obtained when cornerite was attached at edges only, rather than at edges and corner.

The lath and plaster were not stripped from the brick wall, however, until a deflection was reached

nerite samples, was safe from corner crack until after the allowable maximum was reached.

SERIES D-PROPER METHOD JOINING ADJACENT SHEETS METAL LATH.

1. Diamond mesh metal lath butted; No. 18 gage iron tie wire once between studs.
2. Same as 1, tie wire laced from stud to stud.
3. Same, lapped $1/2$ ".
4. Same, lapped one full mesh.
5. Herringbone, lapped selvedge edge only.
6. Same as 5, with one tie wire between studs.
7. "A" lath, lapped selvedge edge only.
8. Same, lapped one full mesh.

In these samples the joint in the lath was horizontal, i. e., at right angles to the wood studs and near the middle of the sample. They were placed on the machine with studs vertical and the load applied in the center vertically downward.

In no case was a crack produced at the edges of the metal lath although the distortion was often sufficient to shear the plaster and lath from the studs.

THE AMERICAN ARCHITECT

Vertical cracks were produced in all cases except D8. From the results it was concluded that the method of joining the adjacent sheets had no bearing on cracking provided the sheets were lapped and tied together.

SERIES E—VALUE OF METAL LATH IN JOINING SHEETS PLASTER BOARD.

1. Plaster board with $\frac{1}{4}$ " gypsum plaster in 2 coats.
2. Same as 1, but with $\frac{1}{2}$ " gypsum plaster.
3. Same as 2, with 6" piece light diamond mesh metal lath laid on joint before plastering.

The joint between the edges of the plaster board ran horizontally and near the middle of the sample

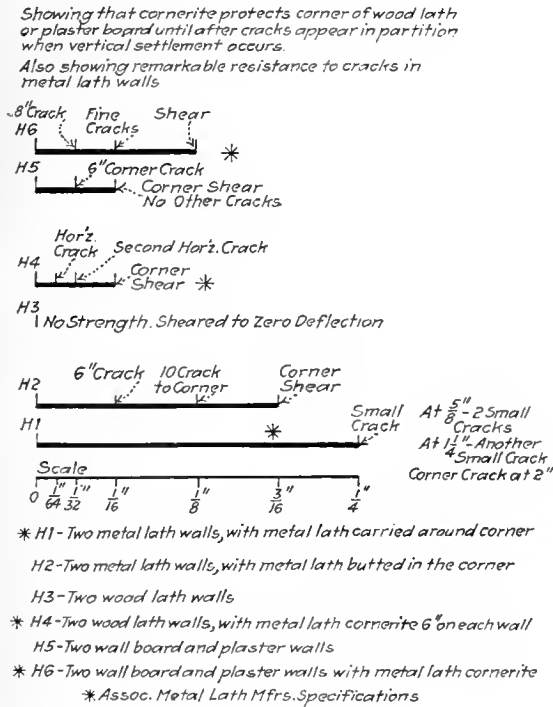

and the load was applied the same as in Series D.

In each sample of this series, a vertical crack through the center of the sample was the first to occur. In sample EI a break along the edges of the plaster board occurred, when a further distortion was applied. Gypsum plaster $\frac{1}{4}$ " thick does not appear to be thick enough to prevent cracks along the edges, but $\frac{1}{2}$ " of such plaster is probably sufficient with or without the use of a metal lath strip laid across the joint. That is to say, with such construction a crack along the edge of the plaster-board will not occur until the distortions are sufficient to destroy the wall.

It is important to put the plaster on to a full $\frac{1}{2}$ " in thickness. On account of the difficulty of inspecting the thickness of the coat and the necessity of building up sufficient thickness to prevent cracks it is

recommended that specifications call for three-coat work as a practical solution.

SERIES F—MANNER OF SECURING EDGES OF ADJOINING SHEETS OF METAL LATH.

1. 2 # Dia. mesh metal lath on 2"x4" studs.
2. 2.5 # Dia. mesh metal lath on $\frac{3}{4}$ " channels.
3. 3.0 # Dia. mesh metal lath on $\frac{3}{4}$ " channels.
4. 3.4 # Dia. mesh metal lath on $\frac{3}{4}$ " channels.

The metal lath was fastened to the wood frame with 4-penny nails spaced 6" apart and was tied to the channels with No. 18 gauge iron wire every 6 inches. Adjacent edges of metal lath sheets were

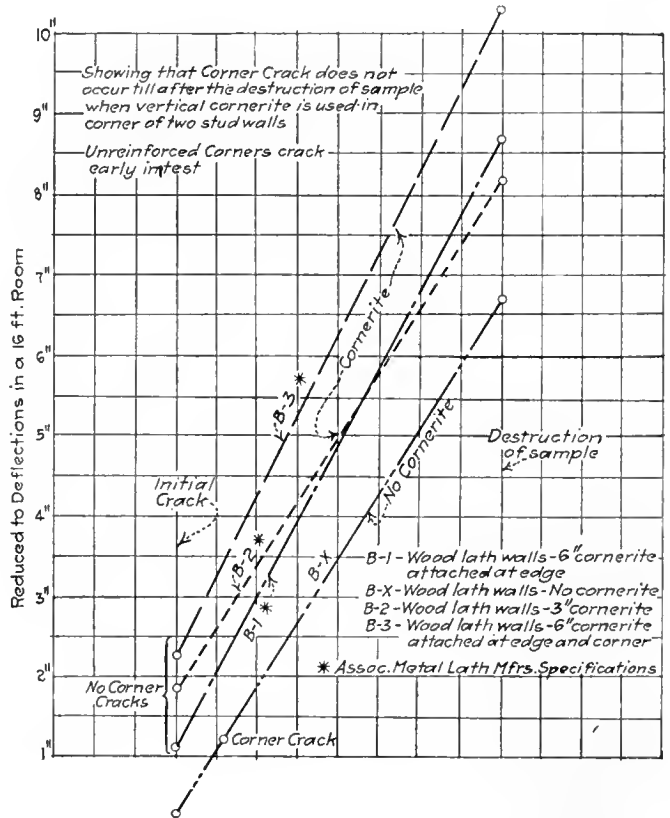

lapped $\frac{1}{2}$ " and tied with one tie wire midway between studs.

The metal lath was allowed to project 6" beyond each end of the frame. These projecting ends were gripped in the jaws of the testing machine to determine if the adjacent sheets could be pulled apart, before a failure occurred in the projecting ends of the lath which were held in the machine.

It was found that on 2" x 4" studs distortion of the wall will not pull adjacent sheets of metal lath apart if lapped and tied with one tie wire.

On metal channels there is a possibility of pulling the sheets apart, because the lath cannot be secured by tie wires to the channels so firmly as by nails to wood studs. In the former case, a careful securing of adjacent edges becomes important.

The object of tests was to determine the deflection

THE AMERICAN ARCHITECT

of metal lath produced by the trowel when the plaster is applied, both at the center of a sheet and at the edge where one sheet is joined to the next one.

The results showed that under the conditions outlined, a tie wire used on metal lath on 2" x 4" studs makes but little difference on the deflection produced in the lath by the pressure of the trowel.

When iron channels are used, a tie wire seems desirable, because of the abnormal deflection produced in the sample having no such tie. Structural irregularities will no doubt account for some of the differences noted but after due allowance is made for such irregularities it appears that the edges should be tied when using metal channels. There is not sufficient difference between the results on sample using one tie wire and the laced sample to warrant a conclusion

(exception of the metal lath walls) the corner crack was the *first* to appear in the samples in which no cornerite was used.

Whenever samples with and without metal lath bent around the corners were tested in the same manner, the comparative results show that cornerite does not induce plaster cracks in the wall surface prior to wall cracks in the samples which did not have cornerite. The metal lath samples, as noted above, were the only exception to this rule, but in order to produce the wall cracks a distortion was required which it would be unreasonable to expect in any safe building.

In the case of the plaster board samples, the walls were composed of a single sheet, and, consequently, there was much less tendency for cracks

to develop in the side walls than would be the case where sheets were joined. However, the use of a cornerite in the plaster board samples, increased the load required to produce a corner shear from 3960 lb. to 6700 lb. and the deflection from 1/16 in. to 1/8 in.

The photographs show that two different actions occurred in the samples. As the load was applied, there was a tendency to produce a straight downward movement of the loaded wall, relative to the stationary or supported wall. This action can produce one of two effects:

1st—It may wear the plaster at the corner, thus breaking one wall free from the other.

2nd—If the corner is sufficiently strong, both plaster surfaces will travel down as a unit. This latter effect can only occur in the case of the metal lath by stripping the lath from the studs or in the case of the wood lath, by shearing the plaster keys.

In the case of sample H-1, the latter effect occurred to a notable extent. The downward travel of the surface nailed to the supported wall was 2 in. and the metal lath was completely stripped from the wood without producing a corner crack. In fact, so strong was the corner that no corner crack occurred until the plaster surface, which had been on the supported wall, struck the support on the bed of the machine and consequently could go no farther.

In the case of sample H-2, the downward travel of the plastered surface attached to the supported wall was 3/16". At this point a shear in the corner occurred. It is to be noted in this case that the shear of the corner was a direct result of the load applied, the surface being still free to move.

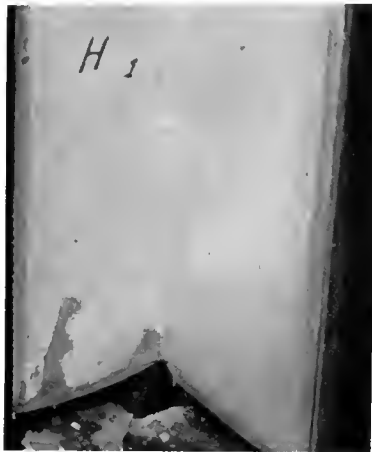

SAMPLE H-1

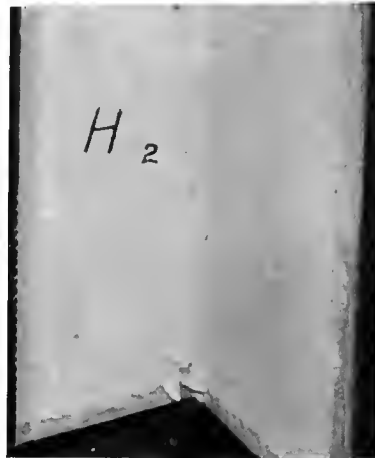

SAMPLE H-2

as to which method is preferable. It seems clear, however, that some method of tying should be used.

The object of Series H was identical with that of Series B, the only difference being in the method. The forms of construction were as follows:

1. Two metal lath walls, with metal lath carried around the corner.
2. Two metal lath walls, with metal lath butted in the corner.
3. Two wood lath walls.
4. Two wood lath walls, with metal lath cornerite 6" on each wall.
5. Two plaster board and plaster walls.
6. Two plaster board and plaster walls with metal lath cornerite.

In some of the tests it was noted that as the loaded wall was forced downward, the plaster on the supported wall moved downward with it, the two plaster surfaces acting as a unit. This was accomplished by tearing the metal lath away from the studs, thus producing a gap in the supported wall between the upper sill and the top edge of the plaster.

In every case where metal lath cornerite was used, cracks in the side walls appeared before the corner crack. On the other hand (with the single

Short Cuts for Calculating and Estimating Reinforced Concrete

By MILO S. FARWELL.

THE purpose of this article is to show the architect some short cuts that may be used in the solution of problems in reinforced concrete design.

The design data used by the writer will be found in any recognized handbook on concrete work, such as Hool and Johnson, Kidder's Pocket Companion and others. For this purpose the writer will use the nomenclature and formulae found on pages 293 to 296 of the Carnegie Pocket Companion, edition of August 1, 1913. He will show how the various formulae can be transposed and condensed so the designer will understand the use of the constants employed, so he will no longer use design tables without some means of checking the results obtained.

DEFINITION OF SYMBOLS USED

- Mc = Moment of resistance of concrete (in.-lbs.)
 fc = Compressive unit stress concrete (lb. per sq. in.)
 k = Ratio depth neutral axis to effective depth d
 j = Ratio of lever arm of resisting couple to depth d
 b = Width beam (in.)
 d = Depth beam to center steel in tension (in.)
 jd = Arm of resisting couple (in.)
 As = Area steel in tension (sq. in.)
 Ms = Moment of resistance of steel (in.-lbs.)
 fs = Tensile unit stress in steel (lb. per sq. in.)
 BM = Bending Moment (in.-lbs.)

Formula 1—For rectangular beams reinforced for tension—

$$Mc = \frac{1}{2} f_c k j b d^2$$

The term $(\frac{1}{2}f_c k j)$ is a constant in the formula, and Ketchum's Structural Engineers' Handbook shows this worked out as 1290. Some engineers use 1280, but either is on the safe side.

$$(\frac{1}{2}f_c k j) = \frac{1}{2} (650 \times .379 \times .873 \times 12) = 1290 \text{ (approx.)}$$

Therefore, **Mc = 1290bd²**

This constant can be used for the solution of Mc for rectangular beams and slabs reinforced for tension.

Formula 2—For rectangular beams reinforced for tension—

$$M_s = f_s p j b d^2$$

In this formula $(f_s p j)$ is the constant.

Referring to the formulae in the Carnegie handbook—

$$M_s = f_s p j b d^2 \\ = f_s A j d$$

Formula 1 determined the resisting moment due to the concrete, and it is the purpose of Formula 2 to

determine the area of steel required for the cross section of the beam or a 12" width of slab.

Since,

$$M_s = f_s A j d$$

Therefore,

$$A = \frac{M_s}{f_s j d} \\ = \frac{M_s}{1600 \times .873 d} \\ = \frac{M_s}{1396.8 d} \\ \text{BM} \\ = \frac{1400 \times d}{1396.8 d}$$

A correct solution of a problem will show Mc slightly larger than the bending moment. In solving the problem for the required amount of steel it is advisable to use the bending moment rather than the resisting moment as the value of the bending moment is the amount the steel must provide for.

Formula 3—The shearing stresses in a concrete beam should not be slighted by the designer as many beams fail because of the lack of stirrups.

An easy method of designing the required stirrups is to employ a formula that will assume the size of stirrup to be used and solve for the distance of the stirrups from the face of the supports. The formula given below determines the distance of the first stirrup from the face of the support. By finding the shear at, say, three feet out from the end of beam the distance of the stirrup at that point is determined. Approximate the stirrups between there and the face and diminish the number toward the center of the beam to correspond to the value of the shear at the point of the stirrup. Stirrups are usually $\frac{3}{8}$ " or $\frac{1}{2}$ ".

Regardless of the number of stirrups about 40 per cent. of the bars should be bent up at an angle of 45 deg. or less. The bend at the top should end not less than one foot from the supports.

Distance in inches of the first stirrup from the face of the support—

$$= \frac{2 \times (\text{area of stirrup} \times f_s \times d)}{(\text{shear to be taken by steel})}$$

THE AMERICAN ARCHITECT

This formula is derived from the data given in Vol. 1 of Hool's book on reinforced concrete.

An item often overlooked in the design of concrete beams is the bending diagrams for the steel bars. These should be shown to be sure the bars will be bent correctly.

The application of these formulae to a practical problem is as follows:

Problem—Assume a simple beam of 18-ft. span which is to carry a uniformly distributed load of 60,000 lbs. Neglecting the weight of the beam, find the size of beam required and the area of steel necessary.

three to be bent up and four to be straight.

The accuracy of the calculations is shown by finding the compressive stress in the concrete under the given conditions of loading.

$$f_c = \frac{2 \times \text{bending moment}}{j \times kb \times d^2}$$

$$= \frac{2 \times 1,620,000}{.873 \times .385 \times 16 \times 32 \times 32}$$

$$= 480 \text{ lbs. per sq. in.}$$

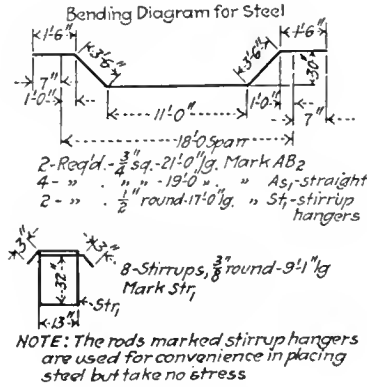
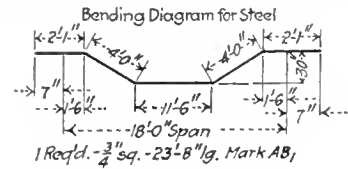
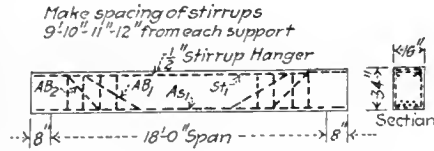

This is less than the allowable stress of 650.

The beam should now be provided with the proper stirrups to take care of the shear. The concrete in the beam will resist a shear of 40 lbs. per sq. in. The equivalent load is 60,000 lbs. and the maximum shear is one-half or 30,000 lbs.

Solution—Bending moment = $W \times L \times 12$

$$= \frac{60000 \times 18 \times 1.5}{8}$$

$$= 1,620,000 \text{ in. lbs.}$$

(By formula 1)

$$M_c = 1290 \times b \times d^2$$

Before solving for M_c assume a size for the beam. In this case we assume a beam 16" wide by 34" deep.

$$M_c = 1290 \times 1-1/3 \times 32 \times 32$$

$$= 1,761,280 \text{ in. lbs.}$$

Note that the value of M_c is larger than the bending moment. If M_c had been smaller than the bending moment, then a larger beam would have been tried.

(By formula 2)—

Sq. in. of steel required for the beam = Bending moment

$$= \frac{14000 \times d}{1,620,000}$$

$$= \frac{14000 \times d}{14000 \times d}$$

$$= 3.3 \text{ sq. in. required}$$

Use seven 3/4" sq. bars having an area of 3.9 sq. in.,

Maximum shear = 30000

Shear to be taken by the beam (16x32x40) = 20480

Shear to be taken by stirrups which are 3/8" round (area .11 sq. in.) = 10520

(By formula 3)

Distance of first stirrup from face to support = $2 \times .11 \times 14000 \times 32$

$$= \frac{10520}{9} = 9"$$

Make the first stirrup 9" from the face of the support.

By interpolation check the spacing at a distance of three feet from the face of the support.

Shear 3 ft. from face = $6/9 \times 30000$

$$= 20000$$

But the beam is good for 20480. Therefore, the stirrups can die out at that point.

On the following pages are some useful charts drawn up by George C. Habicht, showing costs of concrete materials and form work per cubic yard for varying costs of labor, lumber, stone, cement, sand, etc. The explanatory notes indicates clearly any assumptions that have been made as well as the method of using the charts.

Cost Materials—Concrete

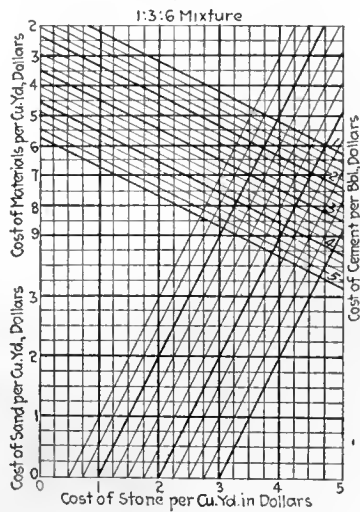
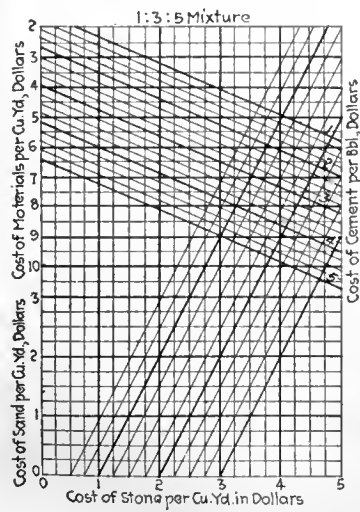
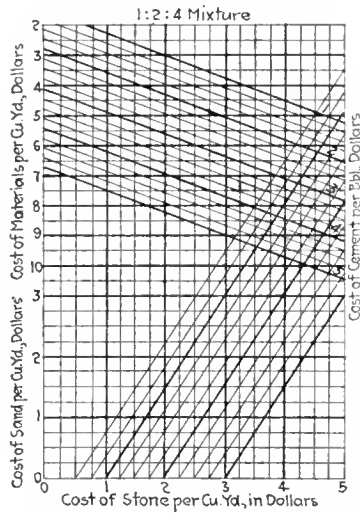
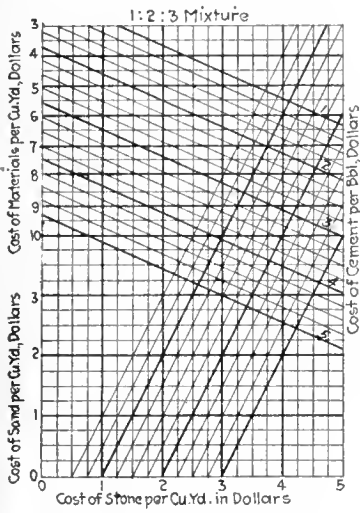
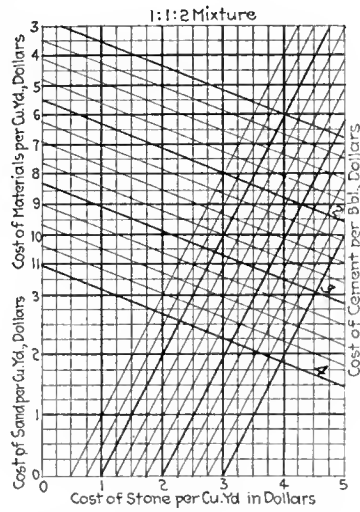
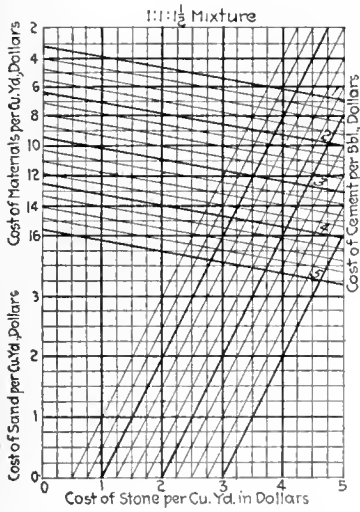

TO USE CHARTS

Assuming a 1:2:4 mixture and prices of \$2.00 per cu. yd. for stone, \$1.50 per cu. yd. for sand, and \$3.00 per bbl. for cement, enter the chart at bottom diagonal line indicating cost of stone (\$2.00). Follow diagonal to intersection with horizontal line indicating cost of sand (\$1.50). Thence follow vertical line through this intersection until it intersects diagonal indicating cost of cement (\$3.00). From that intersection follow horizontal line to left to the total cost of all materials, \$6.62 per cu. yd.

1 bb. cement = 3.8 cu. ft. % voids in stone or gravel = 45. Cement costs are net; bags are not included.

Cost Form Work—Concrete

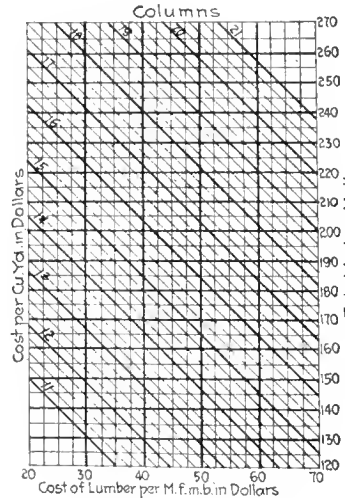
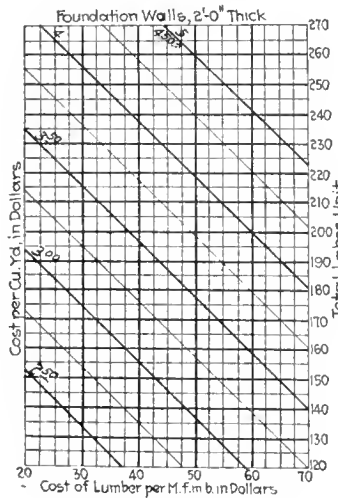
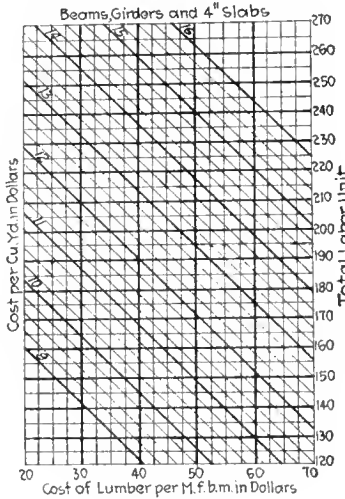
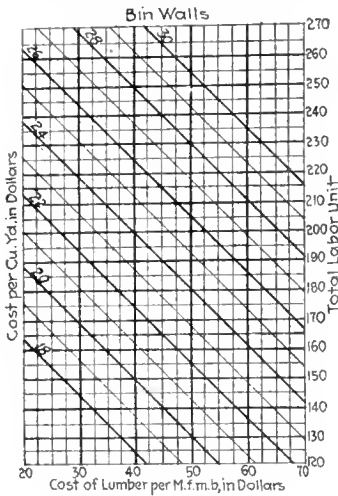
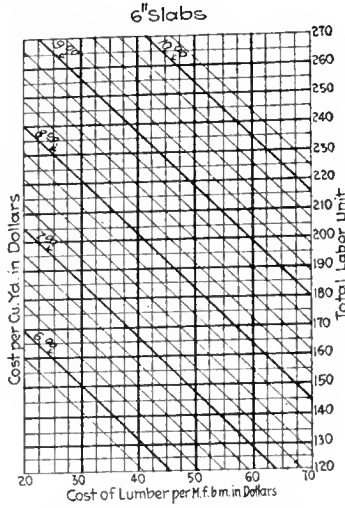
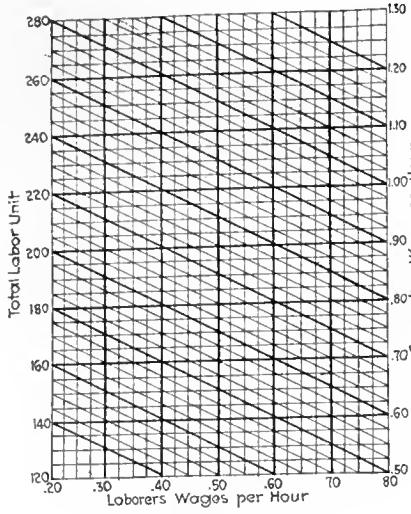

TO USE CHARTS

Assuming carpenters' wages 90c. and laborers' wages 50c. enter chart at 90c. and follow horizontally to intersection with vertical line through labor wage of 50c. The diagonal line through this intersection gives the labor unit, 230. For beams and girders enter chart at 230 labor unit and follow horizontal line to intersection with vertical line through lumber cost, say, \$50 per M ft. b. m. The diagonal through this intersection indicates \$14.58 total cost form work per cu. yd. concrete.

Curves are based on using lumber three times.

The Wisdom of Building Now

What the general public needs, and more particularly at this time, is education as to the exact truth of the present building situation. This education should, of course, come from those elements in the building industry most competent to instruct. Unfortunately, the architects have not, as they very well might, taken the lead in this important campaign. There is no ethical reason why they should not. The bar on advertising having been removed architects as individuals or collectively, through their representative bodies may by a series of well composed advertisements place accessably before the public the exact conditions at this time and the probable outcome in the future.

General contractors throughout the country have been doing this work of education, and to good purpose. A skilfully directed scheme of advertising by a representative firm of contractors has appeared in the New York daily press.

Well written, terse statements are made, attractively set forth with small "cuts." The following is an example of the text:

Maybe you're sitting tight, instead of building a new factory or warehouse now.

You know materials are on the bargain counter and that competition is keen, but you're hoping the bottom will drop out the same as it has in some other lines.

Will it? How about the homes, hotels, office buildings, etc., that simply must be built next Spring and Summer?

If you need a new factory or warehouse, build it now for *Economy*.

'Phone Bryant 2908.

BARNEY-AILLERS
Industrial Construction
"Speed with Economy"

If general contractors find it worth while to pursue such a campaign of education, would it not be equally worth while for architects everywhere to pursue a similar course?

The Standard of Living

An Index to National Prosperity, It Must Be Maintained

According to R. Goodwyn Rhett, of Charleston, South Carolina, a former president of the National Chamber of Commerce, the future of American Democracy depends in a very large measure upon the kind of housing program the United States

adopts at this time to relieve the present shortage of one million and a half family dwellings.

"In taking up the various phases of the problem of making up the shortage of houses," says Mr. Rhett, "we cannot afford to overlook or disregard the bearing which such construction will necessarily have upon the permanent welfare of this country. We cannot afford to countenance or permit any backward step in the standards of living which have been established either by law or by public opinion—for the standard of living of the great mass of the people is the surest index of progress in the march of civilization."

Good Housing Hurt by Shortage

The Evil Rises Through the Ranks, Affecting All Types of Living Places

Endless proofs can be drawn from the literature of Housing Reform to show the demoralization, physical and moral, the dulled minds that accompany bad housing, says Julia Lathrop, chief, Children's Bureau, Department of Labor. The worst evil of a great housing shortage is that it tends to make all housing bad. It crowds indecently, it tolerates the use of abandoned and condemned buildings. It makes unscrupulous owners and landlords charge excessive rentals, ruinous to the tenants. The existing good housing deteriorates under the strain.

Building with Government Aid

Foreign Countries Encourage Construction

A list of the continental countries whose parliaments have provided or are considering measures to protect tenants and to encourage building homes, includes Spain, Germany, Czecho-Slovakia, Austria, Hungary, Belgium, the Netherlands, Switzerland, Finland, Norway, France, Sweden. Naturally the countries in this list which are most depleted by the war are those which need houses most and are least able to build. In Berlin, Moscow, France, Warsaw, Budapest, all housing capacity is carefully measured and strictly rationed according to the size of the family.

Upbuilding the Nation

Why, inquires Senator Calder at the Chamber of Commerce Housing Council, have we not used a larger part of our surplus labor and materials for the upbuilding of our national plant, built more houses so that rents may be lowered; improved our railroads so that our goods can be promptly moved to market, improved our terminals, our coastwise shipping and our inland waterways?

Teach Housing in Schools

Ignorance On This Subject Breeds Indecent Conditions

The principles of housing should be taught in our schools high and elementary, and in our churches of every creed, states Julia Lathrop. Housing is as truly the concern of statesmanship as commerce, industry and agriculture, and international relations. No citizen should be able to escape some knowledge of what housing means and therefore what shortage means.

A housing shortage inevitably lowers living standards. Its effect upon industry is to lower the health, resistance, efficiency of workers and to repel workmen from localities where decent housing is unobtainable, or to make them restless and wretched if they find themselves tied to a location which gives them and their families less than a decent shelter in decent surroundings.

To Reduce Excessive Building Costs

Resolutions Covering This Topic Passed By National Chamber of Commerce

BE IT RESOLVED, That we call upon all persons engaged in the business of manufacturing building materials of every class and character, as well as upon builders and contractors, to exert their utmost efforts to the end that conditions are brought about which will result in immediate reductions in costs of construction.

That we call upon the retailers and distributors of building materials to do their full share in meeting the demand of the people for cheaper building materials. That we call upon labor engaged not only in the construction industry, itself, but in the making of the great variety of materials of all kinds entering into construction, to do its full share, to the end that labor costs, which constitute so large a proportion of the total cost of raw materials and of building, may decline to a point where it will be possible to proceed with construction which is so essential to the health, comfort and well-being of all the people.

That the Chamber of Commerce of the United States make such study of the housing problem, including costs of materials and labor entering into house construction, as will locate the responsibility for excessive costs, and publish its findings so that all may know where the responsibility lies.

For a National Building Code

Chamber of Commerce Suggested as Medium

The Chamber of Commerce of the United States is in a position where it can very well serve the people

by formulating modern, economical, simple building regulations in the form of a code and by concerted effort have this code established in many cities or by state legislatures as a substitute for present codes which in many ways are objectionable because these codes take the form of specifications rather than prohibitions. The reason for having hundreds of building codes in hundreds of different cities is not evident. *The time is ripe for a National Building Code*, especially in the simple types of buildings about which I am speaking. A start has been made and this effort should be continued, stated W. H. Ham, manager of the Bridgeport Housing Co., before the National Housing Conference of the Washington Chamber of Commerce.

Housing Resolutions Passed

National Chamber of Commerce Sums Up Efforts

BE IT RESOLVED, that we, as representatives of American business, urge that each constituent member organization of the Chamber of Commerce of the United States in co-operation with the National Chamber—

1. Make, or cause to be made, a thorough study of the situation in its own community which will bring out the facts as to house overcrowding, erection of unfit houses and changes in house plans or construction that tend to rob the dwelling of its character as a home.

2. Based upon the results of such study adopt a constructive program designed to secure adequate and wholesome housing for all the people.

3. Set minimum standards for light, ventilation, water supply, sanitation and proper construction and maintenance for all dwellings; and take such action as may be necessary to make its conclusions effective.

Housing Problem in America

"Housing Problems in America" is the name of a cloth-bound volume of 386 pages, issued by National Housing Association, as a report of the proceedings of the Eight National Conference on Housing, held in Bridgeport, Conn., December 9, 10 and 11. While practically a carefully edited collection of the various important papers read at these meetings it is at the same time a valuable analysis of living conditions past and present with forecasts, based on undeniable authority of the probable trend of these operations in the future. This volume affords that large number of people who were not able to attend these sessions a comprehensive idea of all the important matters discussed and will be a valuable addition to the architects' working library.

Art Historian Dies

Dr. Max Dvorak, the famous art historian of Vienna University, is dead at Grusbach, Moravia, says a Berlin despatch to the London Times.

Poverty of Immigrants

On three steamships which I inspected recently there were 1,100 persons with only \$1 in their possession. During Christmas week 8,000 arrived with less than \$20, and 4,000 with no money at all.—Frederick A. Wallis.

Boston Architectural Show

Exhibit Now in Progress at Rogers Building

The annual joint exhibition of the Boston Society of Architects, the Boston Architectural Club, and the Society of Landscape Architects, at the Rogers Building, 491 Boylston street, now in progress, will continue through the rest of the month.

It has been the aim of the committee in charge to make the exhibition as comprehensive and interesting to the public as possible. To this end there are exhibits by representative architects outside of Boston who have been especially invited because of the quality and distinction of their work, among whom will be Paul Cret, John Russell Pope, Betram G. Goodhue, Peabody, Wilson & Brown and others.

There will, of course, be the exhibits of the best work from the offices of the Boston architects, comprising drawings, water-colors and photographs of current work and many models of buildings under construction.

A large part of the exhibit of the Boston Society of Landscape Architects is under the auspices of the American Federation of Art, and will prove of great value and interest to the public. The great hall of the Rogers Building has been decorated under the direction of the landscape architects, and serves as a setting for the sculpture exhibit.

The Boston Architectural Club exhibit comprised the work of its atelier, in connection with the Harvard Architectural School, Massachusetts Institute of Technology and Beaux Arts Institute of Designs.

The Allied Arts exhibits contain selections of furniture, hangings, rugs, fixtures, sculpture and garden appurtenances.

The Society for the Preservation of New England Antiquities has comprehensive exhibit of photographs, models and drawings of early New England houses.

The Harvard Architectural School, the Massachusetts Institute of Technology, the Cambridge School of Landscape Architecture and the Rhode Island School of Design are also represented.

Architects Join National Group

San Francisco Men Affiliate With National Congress of the Building and Construction Industry

Local architects and contractors are considering identifying themselves with the National Congress of the Building and Construction Industry, as the result of the talk made regarding that rapidly growing organization by R. D. Kohn of New York City at the luncheon meeting of the San Francisco Chapter of the American Institute of Architects, in honor of Henry H. Kendall, president of the American Institute of Architects.

At the meeting were: G. J. McGilvray, president of the Builders' Exchange; C. A. Day, Chamber of Commerce; Charles W. Gompertz, General Contractors of San Francisco; C. H. Snyder, San Francisco Section, American Civil Engineers; acting Mayor Ralph McLeran, G. A. Applegarth, Ernest Coxhead, J. S. Fairweathers, Morris M. Bruce, W. B. Faville and William Mooser.

At the conclusion of the talk by Mr. Kohn, President G. A. Applegarth, representing the local chapter, appointed a committee to consider local co-operation with this movement.

Revamping the Tenement

Bridgeport Expert Suggests Methods for Civic Associations to Pursue

Most of our cities have tenements below decent living standards. The manifestly practical thing to do is to revamp these, saving the structure itself, but bettering the condition of living by alterations which will furnish opportunities for wholesome living. In order to do this, advises W. H. Ham, of Bridgeport, the simplest and most effective improvements can be made in the surroundings of the building by the introduction of domestic equipment for the household utilities, intense development of the ground space and the introduction of modern plumbing in the house itself and, in many cases, letting in the sunshine through the introduction of properly placed bay-windows or sky-lights and by the wholesome use of paint, inside and out.

In order to make a program of this form of development, some association must undertake the actual reconstruction of some group of tenements which are now below the level of American living. It will, of course, be argued that these additions will raise the rent, but with associated efforts, I am convinced many of these in all of our cities can be operated on a commercial basis today and pay a proper return on the increased value.

Such a program carried to its correct conclusion must introduce a relation between landlord and tenant which will bring about the response on the part of

THE AMERICAN ARCHITECT

the tenant to the decent living conditions provided and which will have its reaction in the proper care of the property so as to reduce to the lowest possible limit the maintenance charges. A very large amount of education is necessary in this particular, but I am thoroughly convinced from our own experience that the results are very easily obtained when the proper disposition on the part of the landlord is most clear to the people.

Summing up our problem briefly, we find that the blight of selfishness has laid a withering hand on the building business. There have been covered frauds by the cheap speculative builder, excessive interest rate charged by the money lender and low return in shirking labor. The industry is hampered by bad laws, both written and unwritten, and by unfortunate customs and compromises on the part of the builders associations and trade unions. These influences are extremely subtle and far reaching, and can be best counteracted by civic associations like the Chamber of Commerce.

Beauty and Utility

A Proper Interdependence Urged Upon the Community

A house must of itself be an expression of the beautiful. Craving for beauty is one of the deepest rooted of human instincts. Mr. R. Goodyn Rett, of Charleston, S. C., discussed this before the recent Washington Housing Conference. We find it, he stated, existing in the geranium pot on the dingy tenement window sill; in the diamonds of the newly rich; in the silver spurs of the cow-boy, etc. If thwarted, it produces restlessness and discontent, the cause of which is often not recognized by the sufferer himself.

If we recognize clearly the value of beauty we shall achieve beauty with utility. America has just passed through an era extending over a generation or more in which utility was lauded, given almost exclusive attention, in which beauty was often thought to be in conflict with utility and because of this considered impractical. This was an era of ugliness in which the suppressed craving for beauty often found grotesque expression—for it could not be suppressed entirely—in decorating es-

entially ugly things with ornaments. It was the era of the false front.

Gradually we awoke to the realization that this was not beauty, that beauty is expressed in form, in line and proportion, not in superimposed ornament. The lines of greatest strength are lines of beauty; ugly lines are weak lines. Ugliness is the mark of failure, of a half done job, of haste and ignorance.

In our housing we must talk utility. We must talk health and sanitation. These are essential, practical, every day matters which must be considered. But if we stop there, if we produce only a bare, uninviting, clean habitation then we shall have failed not only to realize the possibilities of the house as a home, but we shall have failed even to secure full utility, full sanitation. In our clean-up campaigns, the campaign that ends with a bare desert of backyard instead of a garden, fails. It is work that must be done over and over merely to attain a negative result. But when the refuse-filled back yard has been transformed into a garden, which the family can develop and enjoy, then the work is done. So when our unfit dwellings have been transformed into homes when beauty and comfort take the place of ugliness and squalor then the job is done. Then there has been injected the spirit that creates, that impels us to move forward.

Architects to Compete

Manhattan College Invites Six to Submit Plans

To obtain the most artistic and serviceable designs for its new college buildings on the site near Van Cortlandt Park, the trustees of Manhattan College have invited six prominent architects to submit plans in a competition. These firms are: Starrett & Van Vleck, James W. O'Connor, Edward F. Fanning & Philip L. Goodwin, Murphy & Dana, Raymond Hood, Bacon & Delehanty Association of New York City and Maginnis & Walsh of Boston.

Each of the competing architects will receive remuneration. An administration building, college and high school buildings, gymnasium and athletic field are to be constructed. It is planned to start work early in June. About \$1,000,000 is now available.

The college for many years has occupied a large plot at Broadway and 131st street.

Weekly Review of the Construction Field

With Reports of Special Correspondents in Regional Centers

The Architect's Relation to Price Declines

Architects Should Teach the Building Public Some of the Fundamental Economic Laws—Treasury's Savings Associations Offers a Field for Immediate Co-operation

F. E. Davidson, President of the Illinois Society of Architects, practically summed up what may be said here, in this sentence:

"What every student of economics should do, what every architect *must* do, is to teach the building public some of the fundamental economic laws."

The business of teaching a "public" what to do is not an easy matter, and is not susceptible to a list of actual things to be done. It is a vague sort of thing, viewed off-hand; but it becomes very tangible, if studied.

For example, every architect is undoubtedly aware of the Treasury's recently formed loan associations. This organization is offering Treasury certificates in such denominations that they will probably be taken up by the workers of this country. One of the most popular of those denominations is the \$1.00 unit, which is deducted from workers' pay envelopes every week. This is not a dream, nor is it impractical. Millions of dollars worth of these certificates are being bought every week by workers, all over the country. If 5,000,000 workers had subtracted from their pay that \$1.00 per week, the yearly total would be about \$240,000,000. And what is necessary to get the 5,000,000 workers to agree to buy those certificates? Nothing more than a sufficient number of people to *sell* the idea to the people.

The Government now has a trained corps of men in this work, but they are not enough. Why should not every architect in this country do what he can, in his spare moments, to quietly sell that idea? It is a solid thing, backed by the Government. And it is capable of producing millions of dollars of savings (a great deal of which is going into savings banks, to be put out into mortgages and commercial real estate loans). It is a scheme capable of producing money by the hundreds of millions, and a great deal of that money would go into institutions which lend on real estate.

This is not a "fundamental economic law" in the strictest sense of the word, but it is good economics.

There are innumerable instances such as this one, and in them is summed up the architect's relation to

price declines. A general price decline must be met by constructive economics, by quiet, persistent, propaganda for whatever may successfully and actually tend to meet that decline and offset its effect.

An architect can think of a number of things which are susceptible of this sort of activity. In them is summed up the architect's relation to price declines.

Some Vital Questions Answered

Where Is Building Increasing and Where Decreasing?
Are Banks Lending? Have They Money to Lend?
Are They Well Loaned Up? Is There
a Shortage of Raw Materials Sufficient
to Curtail Production?

The Fidelity and Deposit Company of Maryland recently made a nation-wide survey of the United States, and in that survey every section and almost every conceivable worth-while question was covered. The whole thing was done by telegraph, and the investigations conducted by hundreds of men who were either trained in precisely that sort of work or thoroughly familiar with conditions in their respective cities or towns.

The American Architect has been observing the various sections of the country covered by this national survey, and finds that these conditions exist today:

According to the report of the Fidelity & Deposit Co. building operations are *increasing* in New England, South Atlantic, East South Central, West South Central and the Pacific sections of the country. They are *decreasing* in Middle Atlantic, East North Central, West North Central, and the mountain sections.

As to the question, "Do the Banks Appear to Have Funds to Lend and at What Rates of Interest," this proves to be the case:

Yes, in every section of the country mentioned above, and at from 6 to 8 per cent. in those sections, with the exception of West South Central, where it runs 8 to 10 per cent., the Mountain, where it runs 8 to 12 per cent., and the Pacific, where money may be had at from 8 to 10 per cent.

In every part of the country banks are "well loaned up."

In all sections of the country except the Mountain and Pacific there is a shortage of coal, but this is being rapidly remedied in the following sections, improved transportation being the factor: New Eng-

THE AMERICAN ARCHITECT

land, East North Central, East South Central, South Atlantic, Middle Atlantic and West South Central.

In no part of the country was it found that there is a shortage of raw materials sufficient to curtail production. This is even more true today.

(Special Correspondence to THE AMERICAN ARCHITECT)

SEATTLE.—It would appear from quotations received this week that not all steel manufacturers entertain the same standards of measuring the outlook, particularly in sheet metal used in construction. Jobbers of the Pacific coast were advised of quotations of \$5 per ton less on sheet metals, all lower prices coming direct through outside mills. A similar situation prevailed a week ago, with the exception that at that time outside mills were handling their price reductions by means of middlemen. This week there is no hesitancy about the source.

Jobbers are inclined to believe that even though outside mills trim prices of sheets there will be no participation by the Corporation, whose basic prices are believed to be now in force. Statements of unfilled tonnage would serve to corroborate this impression and to make it reasonably certain that enough demand is in sight for the first two quarters of this year, or up to the fall when building commitments decline normally in volume, to warrant present prices. This view seems to have been shared in to a marked degree by investors, and it is certain that architects on the coast are doing all possible to intensify the impression.

The market for galvanized pipe is unchanged. Stocks are now close to what they have been at this time of the year since 1914 and would seem to border closely on normal. The jobbing trade is able to report prompt delivery, with considerable pressure from the mills in the direction of increasing sales. Jobbers are of the opinion that pipe has sounded bottom. Back orders that might be classed as unfilled have been cleaned up, and no builders are now waiting for pipe material to complete work on construction. Halves and three-quarters, which have been short when other sizes were plentiful, are now here in sufficient volume to take care of all requirements.

The supply of brick, patent roofing, plaster, cement and plaster board is plentiful on a stationary market. Coast jobbers viewed with some surprise this week the statements in some of the construction trade journals that prices of cement had been lowered. Their report is that they are paying the same basic costs that have prevailed for 90 days and back into the early fall. Undoubtedly the manufacturers in the north coast territory have reserve stocks on hand that would constitute a surplus and lower market, but they are not offering more than the market can easily absorb.

Surveys of the fir lumber holdings in what is known as the West Coast forest products territory of Washington and Oregon by wholesalers this week indicates clearly that despite the heavy accumulations of lumber as a whole, the stocks that are customarily used to make up eastern yard assortments for building purposes are badly broken. Long dimension is short. Flooring and ceiling are short and dry boards are approaching a clean up in many of the mill yards. The result of this discovery is a stiffening of the market on these sizes and on practically all uppers or finishing essentials despite a softer feeling in the east.

Buyers of the East who draw their lumber supply by rail have delayed so long in preparing for the Spring trade that when they get on the market they will find conditions much stronger in many of the sizes that they could have bought sixty days ago on an easy market.

About 60 per cent. of the fir mills and 40 per cent. of the cedar mills of this territory are now in operation. Red cedar shingles are quiet, and the mills do not care to accept business on this market. Shingles are now under the cost of patent roofing and a splendid competitive angle is therefore offered, but it is evident from the small volume of orders received that the trade is not yet ready to buy.

The farthest that manufacturers and wholesalers of lumber and jobbers of steel and construction materials are willing to forecast the construction revival of the nation is June 1, and there are many indications that there will be a material change for the better by April 1.

(Special Correspondence to THE AMERICAN ARCHITECT)

CHICAGO, February—The building boom of 1921, which has been looked forward to with great interest in Chicago, is not going to be a "dud" by any means, but the conviction is growing that it will not be as big as some of the optimists would have the general public believe.

There there will be building activity goes without saying, but the activity is not going to be as feverish as at first anticipated. The feeling now is that the building revival will sort of stretch itself out for two or three or even five years and that the revival will not really reach peak before 1922.

Expert opinion regarding 1921 seems to simmer the situation down to a considerable volume of home building, a good increase in apartment construction, a pretty fair share of public building and very little industrial construction. Just at present activity continues to remain in the planning and inquiry stages with some improvement, however, in the building permit chart.

Architects continue to report that most of the business is in prospect rather than actually on the boards,

THE AMERICAN ARCHITECT

but the arrival of Spring, it is expected, will bring about a marked improvement in the situation.

Chicago owners, real estate agents and tenants continue to fight the battle of higher rents. Thus far, the argument has resulted mainly in a lot of newspaper talk, some proposed state legislation and nothing much else. Nobody has been moved, apparently, to get busy on any wholesale apartment project, apartments being rather conspicuously absent from the building permit lists of recent weeks.

The obstacles in the path of building resumption, as has been repeatedly mentioned in *AMERICAN ARCHITECT*, seem mainly to be the continuing high price for building materials and labor. Labor in the Chicago building trades—said to be 65% idle at present—declines to accept less than the \$1.25 per hour wage schedule which prevailed during the flush times of the past two or three seasons. Building materials, other than lumber, also seem to be holding up. A convention of building supply manufacturers held this week at a Chicago hotel brought forth the statement from more than one leading manufacturer that building materials are not apt to be much cheaper for some time to come. This statement was made to apply particularly to items such as sand, concrete, brick and other materials which are used in road construction. The basis of the statement was that such materials are being diverted to highway construction, thus taking the burden of depression off the market to a considerable extent.

The public has been holding back and is still holding back on the matter of prices, believing that by waiting a few weeks that prices of construction would be relatively lower. Statements such as have been made at the builder's supply convention and the statements accredited to labor leaders have a tendency, apparently, to determine prospective investment builders to let the whole plan wait for another season. The home builder is not so fortunately situated. Between the Scylla of the high rents and the Charybdis of the high construction costs, he gives evidence of preferring the latter course, with the result that the building of homes, both pretentious and plain, will be one of the principal lines of activity during the early Spring.

Suburban building is being given rather special emphasis. Real estate men along the north shore, which is the residential strip for the wealthy Chicago commuter, report considerable demand for residential sites and the same demand, in perhaps lesser degree, is reported in other of the better suburbs. Plans have just been announced for the early construction of twenty bungalows at Glenn Ellyn, a western suburb and this announcement is regarded as a harbinger of many similar announcements in the immediate future.

Another impetus to the building of homes of

frame construction will be recorded if the city council acts favorably upon a proposition now before it to render the fire limits more elastic and thus to permit the construction of wooden buildings in territory now forbidden to buildings of this character.

This proposition is rather strongly opposed by the Illinois Society of Architects. Acting through F. E. Davidson, president, the Society proposes certain revisions of the building code to permit the cheaper construction of brick or concrete bungalows, rather than a revision of the fire restrictions, which the Society believes should be opposed by those interests having at heart the future of the city.

"As a matter of cold figuring," Mr. Davidson insists, "a brick bungalow can be built today at approximately the same cost as a frame building of the same dimensions, in detail and with the same finish."

The question of amending the fire restrictions is now before the council, the matter having been officially brought before the council at the suggestion of the Carpenters' Union.

The home building idea will doubtless be greatly encouraged by the "Own Your Home" Exposition, which will be held at the Coliseum from March 26 to April 2. The Exposition proposes to show the average flat-dweller that the ownership of a modern home is within his financial scope and ability. Co-operating industries are working in close harmony to make the Exposition an absolute success and preliminary preparations are already well out of the way. One of the exhibits will be the collection of small house plans and designs. The exhibit will comprise fifty designs submitted in the nation-wide architectural contest. The three prize-winning designs—the best gathered in the \$15,000 contest—will be exhibited.

It is the rare week in Chicago, during recent months, when somebody does not come to the fore with a plan for solving the housing shortage painlessly. The recent week brings a project for "poured" houses of four rooms to be built at a cost of \$2,100 each. Mayor William Hale Thompson has bestirred himself in behalf of the "poured" house proposition and is interested in the first set of one hundred which is to be platted in an addition to Oak Park, a Chicago suburb. It is the contention of those who favor the plan that such houses can be built from cellar to garret—both cellar and garret being conveniently absent—in seventy-six hours, at a cost of \$2,100 each. The owner is to acquire the house on the payment of \$100 down and the remainder in some such convenient sum as \$20 or \$30 a month. The project is being watched with interest, not only by newspaper paragraphs, but by the building industry.

There has been very little price adjustment in the local market either in lumber or other building materials. As far as lumber is concerned, the prices

THE AMERICAN ARCHITECT

that have prevailed for some time are still in effect, the demand for spot turnover of lumber being negligible, though subject to some improvement in recent days. Building materials are showing greater strength and more activity, though prices have been subjected to very little change. Present values in the materials field are about as follows:

	Per Bbl.
Portland cement	\$2.55
This price does not include sacks, which are \$1.00 a bbl. extra.	
	Per Yard
Torpedo—Lake and bank sand.	\$3.50
Crushed stone, grav. screenings.	3.50
	Per Ton
Hydrated lime, Ohio, paper.	\$21.00
Hydrated lime, Ohio, cloth.	29.00
Including sacks at 30 cents each	
Hydrated lime, Wis. paper.	19.00
Bulk lime	1.65
Neat plaster	20.00
Prepared plaster	15.00
Magnesite Stucco, base coat.	50.50@55.00
Do finished coat	50.00@55.00
Dashes (all kinds)	28.00@40.00
Wood fibre	20.50
Prepared finished	36.00
Face brick—	
Standard, vitrified red	32.00@34.00
Smooth, Indiana red	38.00@40.00
Smooth, Ohio red	38.00@40.00
Smooth Pennsylvania red	46.00@48.00
Smooth, buff	45.00@47.00
Smooth, grey	47.00@49.00
Rough, buff	44.00@46.00
Rough, grey	47.00@49.00
Variegated, rough texture	34.00@49.00
These prices delivered by truck from cars:	
Common brick	\$13.00@16.00

(Special Correspondence to THE AMERICAN ARCHITECT)

BOSTON.—To stabilize the building industry in Connecticut, to regulate conditions of contracts and to discourage the charging of "outrageous rates of

interest on money loaned by banks and others to prospective builders" are some of the announced purposes of a State Building Contractors' Association which has just been formed at Hartford. It has an initial membership of more than 300 contractors, representing building, plumbing, electrical, roofing and other construction trades.

Members of the association include members of builders' exchanges established in several Connecticut cities who have recognized that mutual interests have been injured and the building trades hampered by certain contractors outbidding others by paying a few cents more an hour to employees, with the result that while one contract might be hurried to completion, another quite as important might not be completed within the time limit. It is proposed to put a stop to "stealing" each other's help, also to establish such a level of wages for employees, in all lines of the building trades, as will permit a necessary readjustment of the business to a peace-time standard. That it will be necessary to reduce the general wage scale from 20 to 25 per cent. is the opinion of the members.

It is estimated that 80 per cent. of the employed men in the building trades are unionized and that in Hartford alone, about 3,000 men would be affected by a new scale of wages. The builders want it to be distinctly understood that they do not wish to antagonize labor, but they do want to stimulate a volume of building which they believe would be sure to come if some of the obstacles were removed. Furthermore, they plan to insist upon abolishing the bonus system attached to building loans, and will advocate some plan whereby building operations may be more easily financed.

Things in New England seem to be working towards a period of greater stability in prices, in wages, in internal and international affairs which will no doubt have a highly beneficial effect on our business welfare. "Whether one takes an optimistic or pessimistic view of the future," says one observer, "largely depends on whether he is viewing these readjustments and uncertainties by themselves, or as preparations for a greater and more prolonged period of commercial prosperity in the future."

262^a

Francis James to 9/10 2357.



TOMB OF BEATO PACIFICO BUON, CHURCH OF SANTA MARIA DEI
FRARI, VENICE, ITALY

THE AMERICAN ARCHITECT

263

VOL. CXIX

WEDNESDAY, MARCH 9, 1921

NUMBER 2359



THE PARTHENON

From Greek Refinements. By William H. Goodyear, M.A.

The Basis of Beauty

BEAUTY, the principal attribute of the things we most desire, makes a universal appeal. This is especially true within the realm of the fine arts. Any discussion concerning beauty will naturally interest architects owing to the nature of their work and its creative possibilities. They will be most delightfully entertained by reading an article by Mr. W. Carlys Zimmerman, architect, entitled, "The Basis of Beauty," in February issue of *The Atlantic Monthly*. The reading is conducive to further thought and speculations on matters that now claim the attention of architects, possibly more than any other persons whose work involves artistic expression. Mr. Zimmerman's article is written in the form of a discussion between the ancient philosophers, Socrates and Plato, in which he very cleverly explains the underlying principles which should be

the basis of our judgment or opinion concerning beauty as a property of architecture.

Plato has been asked to express the regrets of Ictinus and Pheidias that Socrates was unable to attend the festival celebrating the completion of the Parthenon and he voices the opinion of the architects and artists that it is the most beautiful temple in the world. To this opinion Socrates demurs, much to the surprise of Plato, who has accepted the judgment of the architects and artists, and the discussion is under way.

Plato opines that Ictinus must have followed certain rules and laws when he designed his masterpiece and that these laws when applied, would establish as marks of art, all buildings conforming to them. Socrates rejoins by saying that these laws would be found to pertain to good building and that

THE AMERICAN ARCHITECT

architecture is distinct from building. Rules that we will accept will result in good planning and construction. Debating the proposal that a *true* law can govern these features of a good building that appeals to the aesthetic sense, Socrates concludes: "No, Plato, art cannot, in the very nature of things, be subject to laws. If the fine art of architecture were subject to rigid laws it would then be the science of architecture . . . and all who know these laws would agree without dissent on what is beautiful and what is otherwise." It would naturally follow that all capable of interpreting the law would be of a common mind. This is impossible as all the faculties of perception and reflection are individual and these laws when executed would render different impressions. Even these impressions would not be constant because constancy in opinions held by the same person is not a human attribute.

To digress, beauty cannot be a fixed and determined quality. As defined by Pindar, "beauty is the individual's conception of perfection. The fact that standards vary does not alter the principle. Standards of beauty must differ as individuals differ."

Socrates evidently has confidence in the opinion of the man of the street, if he thinks for himself, because it would be what was natural to an unspoiled and unsophisticated taste. Plato contends that the judgment of those who are men of experience, education and culture, should be generally accepted. Socrates argues that "a true law would not be affected by the entire extinction of our race; and even the complete annihilation of our planet would not affect it. Any three stars or points would continue to exemplify Pythagoras' discovery of a law to which we all bow, and which, under all circumstances and conditions, remains eternally true." It does not require deep reflection to appreciate and accept the fact that beauty cannot be subject to a true law as it is a perishable thing subject to the mortality of the individual or his inconstant opinion. Hence the basis of beauty is but the individual opinion. The expression of beauty as it might emanate from all kinds and conditions of men is very entertainingly discussed by Socrates, who concludes by saying that the "*Sum Total of Happiness, the Sum Total of Pain and Pleasure is the same for all mortals.*"

Throughout the entire discussion, Socrates makes an indirect plea for tolerance and a consideration of the opinion of all others, even the man on the street. Intolerance is the characteristic of the intellectually limited man and its practice is always a brake on progress. The teachings of many architectural schools and the clamour of the self-appointed juries of architects and artists have thoroughly imbued the

mind of the unthinking public with the idea that any departure from certain standards is unorthodox and it should be taboo. Who can say how many truly beautiful architectural expressions have been lost to the world through the intolerance of groups of architects and those they influence?

It is this influence which recently caused the directors, made up of members of the most progressive profession in the world, to demand that a new building have a typical doric base, columns, entablature and pediment—such as we see anywhere and at any time. A truly beautiful design as submitted was lost to the world and we, who pass on the street, have lost something in the way of an arresting impulse and a mental stimulus that would be welcome.

Referring to another art, Agnes Repplier, in the same magazine, comments on the rather bitter and amusing war between the various schools of poetry and says that "Miss Amy Lowell was right when she said, with her customary insight and decision, that the beliefs and protests and hates of poets all go to prove the deathless vigor of the art. Unenlightened outsiders took up the quarrel with pleasure, finding relief in a dispute that threatened death and disaster to no one." If architecture possesses "deathless vigor" it will be evidenced by the awakening of discussion, by demands that architectural schools desist from training intolerant, single-track students, by an effort to liberalize public opinion and a revival of the creative instinct in the individual.

Our private libraries contain many volumes of all kinds of poetry, a small percentage of which meets with our individual approval. Happily, the balance remains out of sight and mind. Architecture, however, is made manifest in a material structure, ever present to those who see. For that reason a tragedy in architectural expression is deplorable. Assuming that freakish, unbalanced and radical designs are tragedies because they exist unbidden to plague us for long periods of time, could there not be tragedies in a duplication of slavish imitations based on a law, a rule or a style or a school of architecture, thus depriving the world of the inspiration of unborn architectural beauties? The creative spirit is associated with the spirit of adventure and if properly co-ordinated they must develop a beauty that will appeal to large numbers who have an inherent right to enjoy beauty as they may see it.

Mr. Zimmerman's article will naturally yield impressions that will be individual and whatever they may be, the consensus will be towards a spirit of tolerance and a questioning of many things as is. It is most timely.



GARDEN FRONT

HOUSE OF ROBERT J. THORNE, LAKE FOREST, ILL.

JOHN W. McKECKNIE, ARCHITECT; N. MAX DUNNING, ASSOCIATE ARCHITECT



THE GARDEN

HOUSE OF ROBERT J. THORNE, LAKE FOREST, ILL.

JOHN W. McKECKNIE, ARCHITECT; N. MAX DUNNING, ASSOCIATE ARCHITECT



LIVING HALL

HOUSE OF ROBERT J. THORNE, LAKE FOREST, ILL.

JOHN W. McKECKNIE, ARCHITECT; N. MAX DUNNING, ASSOCIATE ARCHITECT

Some Solid Facts on Construction Costs

Where Are Prices Today, and What Is the Real Significance of Lowered Building Construction Costs? Is the Labor Bureau Wrong? How Much Cheaper Can You Build Today Than at the High Level of 1920?

By F. E. Davidson, A.I.A.
President, Illinois Society of Architects

THE clothes the ordinary professional man wears will serve as an illustration of what I shall say here.

Suppose we compare his all-wool suit to the masonry of a building; the shoes, hosiery and underwear to the foundations and frame work; the white shirt to the painting and decorating; the collar and cuffs to hardwood flooring and trim; and the hat to the roofing.

Now assume, for the sake of argument, there being in our problem five factors, that the cost of the suit has been reduced five per cent., the shoes, hosiery and underwear, 10 per cent., the white shirt, 50 per cent., the collar and cuffs, 80 per cent., and the hat, 50 per cent.

What is the correct method of figuring the reduction in price to the man who is to buy, or has bought, those articles?

The Labor Bureau's method of computing the percentage of reduction in this instance consists in adding the total percentage reductions of the individual articles and dividing by the total number of articles. The various percentages total 195 in this particular instance. The Labor Bureau divides that number by 5 (number of factors) and then tells the purchaser of those articles

that the percentage of reduction in cost to him was 39 per cent. But is that figure and that conclusion of any value? Not at all.

WHAT INTERESTS THE PURCHASER?

The building public, for example, is not interested in how much mahogany trim or oak flooring have been reduced recently. It is interested in the average reduction in the total of all materials actually used in the construction of a building. Suppose that the cost for the lumber for mahogany trim has been reduced 200 per cent., the cost of hardwood flooring 150 per cent., and the cost of all structural timber, 40 per cent. What does this amount to when the cost of the structure is considered? The amount of mahogany trim used is so small that it would probably not amount to 1/10 of 1 per cent. of the total cost of the structure (even if mahogany trim is used). The cost of hardwood flooring in any building would probably not amount to 1 per cent. of the

PROJECT No. 1

Ralph C. Harris, Architect

A three-story English basement 18 apartment building, each apartment consisting of six rooms and three baths. Size of living rooms 18x25 ft., dining rooms 16x20 ft., chambers 14x17 ft. Nothing unusual in the construction and equipment of the building, and medium high grade standard materials were specified.

Low bids received on January 10 are not from the same contractors who submitted low bids May 20, 1920. All estimates, however, were presented by reliable firms

	May 20, 1920	Jan. 10, 1921	Per cent. difference
Masonry	\$44,300.00	\$40,220.00	9.4
Carpentry	74,000.00	55,700.00	24.7
Concrete	5,200.00	4,650.00	10.5
Stone	5,578.00	6,200.00	7.6
Plumbing	28,100.00	25,870.00	.8
Heating	11,250.00	10,600.00	.6
Electric	4,525.00	4,300.00	.5
Plastering	22,200.00	17,400.00	20.5
Steel	4,629.00	4,209.00	11.2
Sheet Metal.....	2,890.00	2,960.00	.17
Painting	14,920.00	12,300.00	17.6
Glass	2,113.00	2,200.00	4.6
Tile	5,843.00	5,700.00	2.4
Totals	\$225,548.00	\$192,229.00	14.75%*

*Average decrease.

Mr. Davidson recently obtained some figures from architects, who submitted bids on the same projects in the "peak" period of 1920 (construction of which was held up) and after January 1, 1921.

These, and figures for Project No. 2, show the differences in prices of all materials used in the construction of these buildings.

Both tables also show just what Mr. Davidson means by "average reduction in the total of all materials actually used in the construction of a building."

total cost of the structure, and when it is remembered that the total cost of all timber and lumber, even in a standard mill building, only amounts to about 10 per cent. of the total cost of the structure, it will be obvious that large reductions in a few

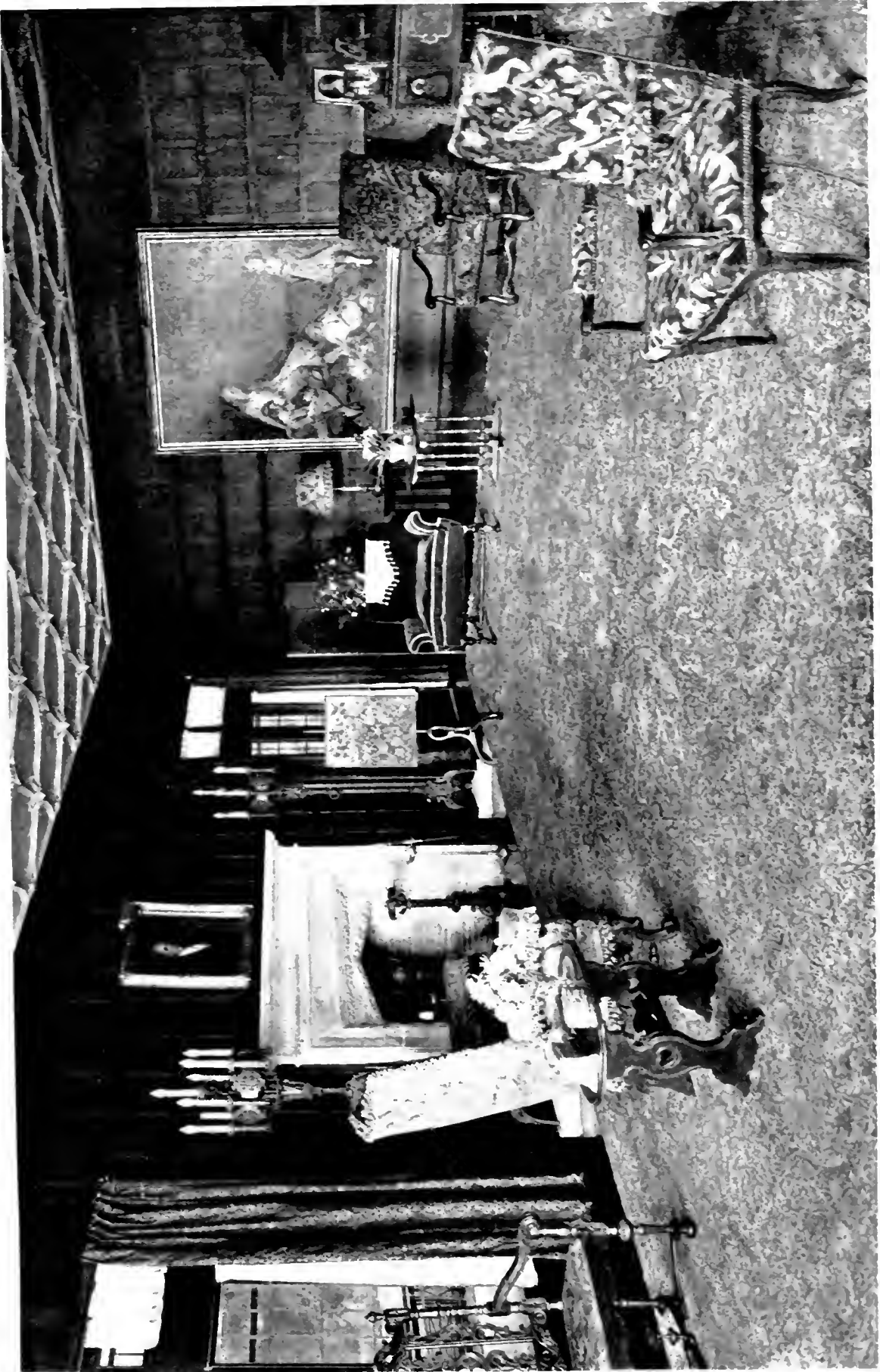

LIVING ROOM
HOUSE OF ROBERT J. THORNE, LAKE FOREST, ILL.
JOHN W. MCKECKE, ARCHITECT, S. MAX DENNING, FURNITURE ARCHITECT

THE AMERICAN ARCHITECT

items will not materially affect the final figures. I feel that what the American building public should be taught through such journals as *THE AMERICAN ARCHITECT* is what the percentage in reduction in the complete structure amounts to, and not have so much emphasis mistakenly placed on the very large reductions which have been made in certain specific items, the cost of which, when considered with the total cost of any structure, is very small.

Everyone interested in the building industry must know that building costs are lower than they were at the peak during the year of 1920.

So many erroneous statements, however, have recently appeared in the public press as to the amount of these decreases that so evidently have been based on either incomplete data or have been issued in an attempt to create a false impression of the actual situation that it appears to be opportune that those interested in building construction should be advised as to approximately how much cheaper buildings may be constructed today than at the high level of 1920.

THE CORRECT METHOD

Predictions to the effect that by May 1 next, "the 1914 price levels for building costs will be reached," are so absurd as to justify the serious questioning of the sanity of any man making such a prediction. Nevertheless, at present, the building public is waiting and hoping for lower prices, and, like a small boy passing a graveyard at night, are whistling to keep up their courage. But whistling will not bring down price levels nor will it construct any buildings.

At a recent meeting of the Illinois Society of Architects I requested data on this matter. I asked that any architect present who had taken competi-

tive bids since January 1 on any project upon which competitive bids had been taken during the middle of 1920, but the construction of which had been postponed, prepare a table showing the percentage of increase or decrease of each item and a brief description of the project. The tables printed herewith illustrate what I look upon as the correct way to figure lowered construction costs.

More Figures on "Average Reduction"

PROJECT No. 2

Davidson & Weiss, Architects

A small manufacturing plant located on a switch track of the Belt Railroad in Chicago. Plant composed of a number of one, two and three story standard mill sprinklered buildings, including a separate power house. Plant designed to secure the most economic construction costs. Figures quoted are by the same contractors in each case.

	July 19, 1920	Jan. 19, 1921	Percent- age of in- crease or decrease
Masonry, Concrete and			
Carpentry	\$281,480.00	\$249,740.00	-11.2
Radial Brick Chimney....	5,930.00	5,870.00	-1.0
Water Tube Boilers....	14,590.00	14,224.00	-2.5
Furnaces	3,400.00	3,400.00	-0.0
Structural Steel and Misc.			
Iron	32,330.00	25,740.00	-20.4
Steel Sash	21,814.00	24,569.00	+12.12
Fire Escapes	2,872.00	2,738.00	-4.5
Fire Doors, etc.....	6,525.00	6,310.00	-3.3
Hollow Metal Doors....	1,857.00	1,857.00	-0.0
Sheet Metal Work.....	5,076.00	4,560.00	-10.16
Glazing	19,920.00	21,980.00	+10.68
Plastering	7,715.00	7,715.00	-0.0
Cut Stone	1,360.00	1,250.00	-8.09
Elevators	5,200.00	4,500.00	-13.46
Roofing	16,570.00	16,400.00	-1.02
Tile Flooring	102.00	92.00	-9.8
Painting	13,763.00	12,662.00	-8.0
Heating	70,000.00	61,000.00	-12.8
Pipe Covering	5,062.00	4,556.00	-10.0
Electric Wiring	24,336.00	21,006.00	-13.6
Sprinkler Equipment....	34,956.00	32,115.00	-8.1
Gravity Tank	7,075.00	6,297.00	-10.9
Plumbing and Drainage..	20,290.00	19,276.00	-4.99
Fire Pump	3,125.00	3,425.00	+9.63
Totals	\$605,348.00	\$551,282.00	-8.931

What would a substantial reduction in the Glazing have meant in Project No. 2? The figure was \$19,920. Suppose there had been one of the "striking reductions" in the price of Glazing; and suppose it had cost the cost of the Glazing in this project \$1,000. What is the ratio of \$1,000 to \$605,348? What does it amount to after all, in the total result? There you have my point. \$1,000 is \$1,000, I grant you; but \$1,000 is a rather insignificant item in a total cost of \$605,348.

It is, of course, obvious to every student of the situation that, until labor costs are lowered and until freight rates are reduced, building costs cannot and will not be materially lower than they are at the present time.

WHAT EVERY ARCHITECT MUST DO

As I have repeatedly predicted, the average price level of building material costs will follow in general the price level of all commodities, and the price level of commodities will parallel the curve representing monetary circulation, as well as loans and discounts. The American public must become accustomed to doing business on a higher price level than before the war.

What every student of economics should do, what every architect *must* do, is to teach the public some of the fundamentals of economic laws and assist in

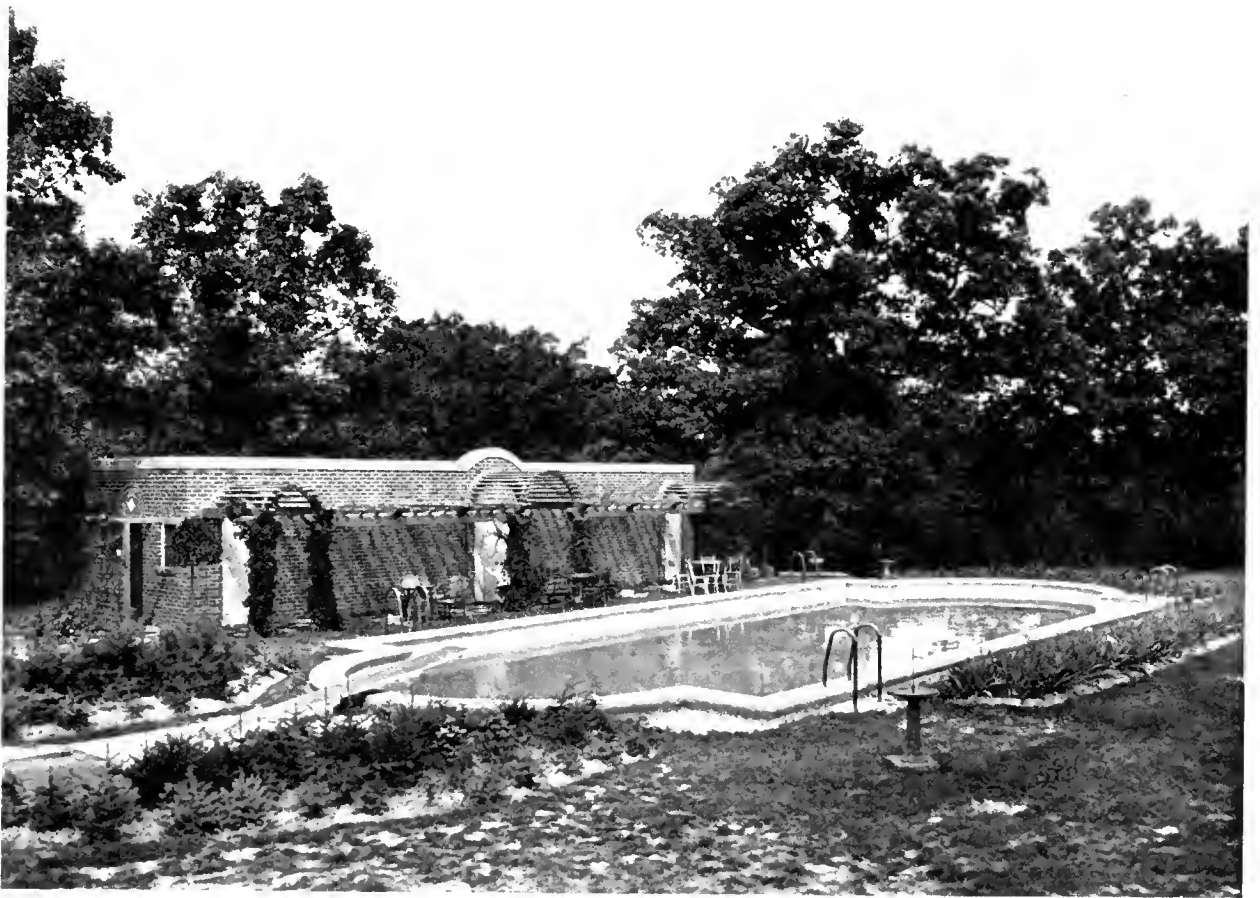

SWIMMING POOL, SHOWER BATHS AND DRESSING ROOMS



GATE LODGE

HOUSE OF ROBERT J. THORNE, LAKE FOREST, ILL.
JOHN W. McKECKNIE, ARCHITECT; N. MAX DUNNING, ASSOCIATE ARCHITECT

promoting the economic truth that the best interests of our nation at this time will not be subserved by the wiping out of any portion of our circulating medium, or in making any material reduction in the volume of credits, but in the stabilizing of conditions. As soon as those interested in building construction have been convinced that costs are more or less stabilized, construction work will start and all of the conventions or conferences that may be held will not change this economic fact.

Let us therefore face conditions as they are and so shape our course as to be in accord with economic laws which cannot be amended by any resolution of any convention, nor be repealed by any act of legislatures.

Rome Extending Her Area

Ancient City Reclaims Campagna for Ampler Food Supply and More Room for Her People

Through the reclamation of the Campagna Romana, the vast tracts of land which for centuries have lain fallow and neglected for miles around Rome are to be the scenes of new life and hope. That this land should be restored to productiveness has long been the dream of Italian economists and that it is being realized in a surprising degree of progress is now borne out by official reports.

The Campagna to the modern world is a land of marshes and malaria, dotted here and there with remains of ancient Rome and cut by the still existent chariot roads that led from the imperial city to the provinces of the empire. The only habitations are the huts of the herdsmen who watch the half wild cattle, for the peasants who work small and more favorably situated tracts make their homes high on neighboring hilltops. From May to the end of the year the few people remaining on the Campagna lead a miserable fever stricken existence. William D. Howells has told us of its charms for the antiquarian researches, Henry James in his "Daisy Miller" of the perils of its miasmatic night air and Dumas and other novelists have peopled it with bold, daring brigands, though in reality even the husky bandits of romance could not survive in its malarial marshes.

Against this untoward condition is set the conditions of the Campagna of the Roman Empire as described by ancient writers. Then it was a densely populated, prosperous district with a perfect system of drainage and more healthful than Rome itself. The present most desolate section of the Campagna, the strip from Monti Albani to the sea, was the home of the ancient Romans who won their supremacy over their neighbors and ruled the then

known world. The decline came when the small farms gave way to the large landed estates.

Many of the great Popes tried in vain to reclaim this land. A law recently passed decreeing that land not cultivated to its utmost capacity is liable to confiscation was the real turning point. The owners of some of the largest estates undertook their cultivation. The results were beyond their greatest expectation; the land, which seems to have stored up the fertility of centuries, yielded immense returns on the labor. Hundreds of acres on other estates have been reported drained, plans made for irrigation and modern farm machinery installed. These efforts are believed to be the beginning of a restoration which will eventually include all the arable tracts of the Campagna. In this transformation the ancient city sees a new hope for the supplying of her two greatest needs, a nearer and cheaper source of food and a chance for the long demanded extension of her present limits.

Model City for China

Young Native Plans to Build Chinese-American Town on His Estate

S. Won-Kingsing, a young Chinese graduate of the University of Minnesota, is planning the building of a model city to be called Gee Len, in the province of Kwang Tung, China. Won-Kingsing, who is but 25 years of age, has been in the United States for the past five years, and after graduating in an academic course, has devoted his time to the study of living conditions and education of his race. His father died recently leaving him 700 square miles of heavily timbered land, and it is on this that he plans his Chinese-American city, which will be a model in many ways for many others to be constructed later throughout China. Some of the fundamentals of the first known apartment house, which is in China, will be incorporated in the modern ideas of the American architects.

In his project, Won-Kingsing has the co-operation of many leading Chinese educators and business and Government officials both here and at home. He has been through the big tract of land on hunting trips. It is now unsettled, as it is a dense forest of hardwood, akin to teakwood. There is enough lumber available, he says, to support the little model colony right from the start, while as the land is cleared it will be very suitable for sugar planting and the raising of other valuable commodities.

All that is best in American home construction that can be combined with Chinese conditions, school buildings, hospitals, churches, Chamber of Commerce, wireless stations, etc., will be built, he says.

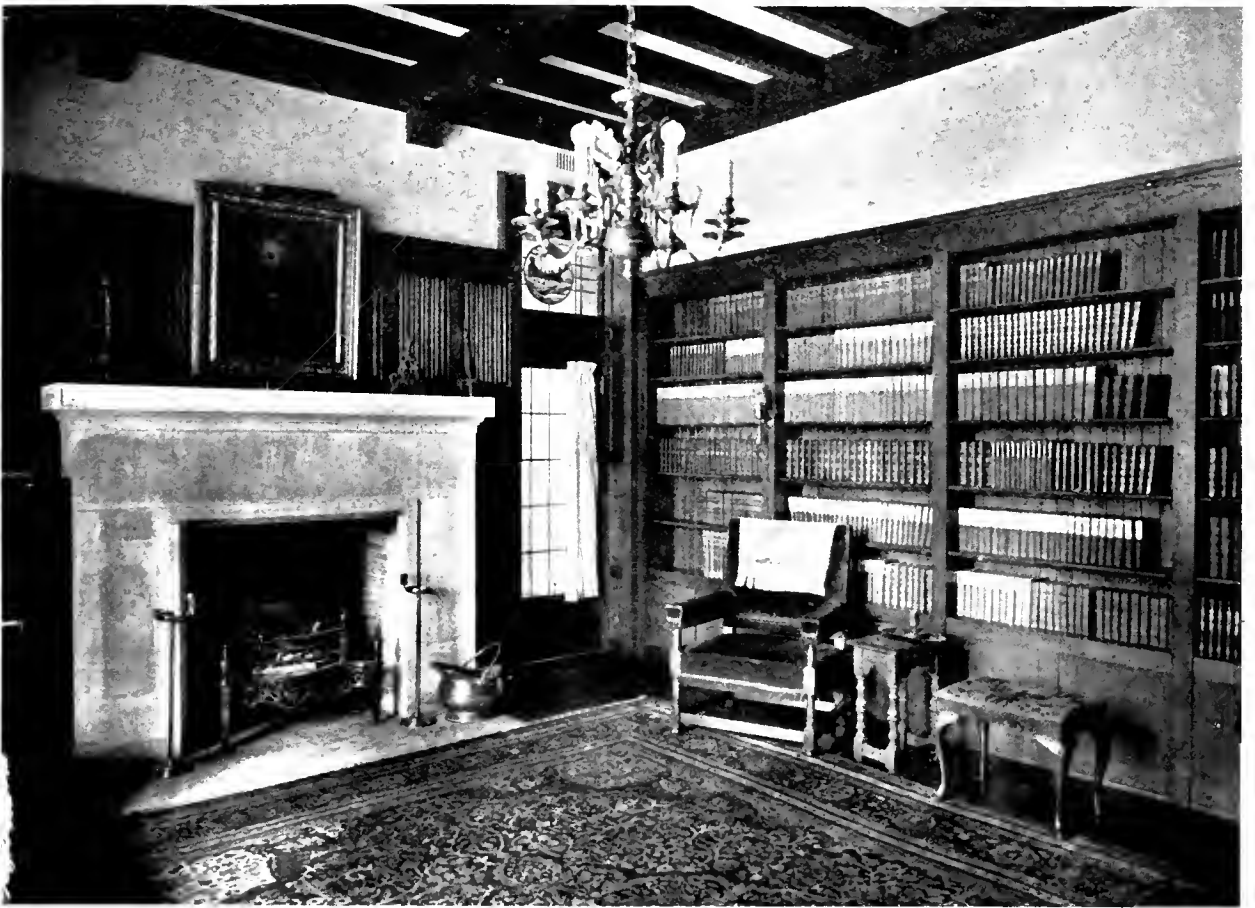

LIBRARY



DINING ROOM

HOUSE OF ROBERT J. THORNE, LAKE FOREST, ILL.
JOHN W. McKECKNIE, ARCHITECT; N. MAX DUNNING, ASSOCIATE ARCHITECT

Old Dutch Farm House, Staten Island

(See Reproduction of Original Drawing by O. R. Eggers on Opposite Page)

The sturdy qualities of the Dutch who settled Manhattan Island and spread out across the Hudson to New Jersey and seaward toward Staten Island are well typified in the house selected by Mr. Eggers for the present illustration. Low in height and broad in expanse, this colonial farm house solidly sits its site. One may imagine the stolid burgher taking his ease on the wide spreading porch, sheltered from the oppressive heat of the summer sun, or during inclement days in winter equally snug and comfortable before the stone fireplace of the low beamed kitchen ceiling.

Few of these oldtime farm houses remain, and when he who tramps the unfrequented highway comes upon one, the charm of its picturesqueness is appealing.

The wide clapboarded walls and the adze-hewn shingles have taken on the most wonderful colors, the effects of many years of aging. In some instances these old houses are embowered by climbing vines whose sturdy trunks indicate the many years of their growth.



274^a

OLD DUTCH FARM HOUSE, STATEN ISLAND, N. Y.
THE AMERICAN ARCHITECT Series of Early American Architecture

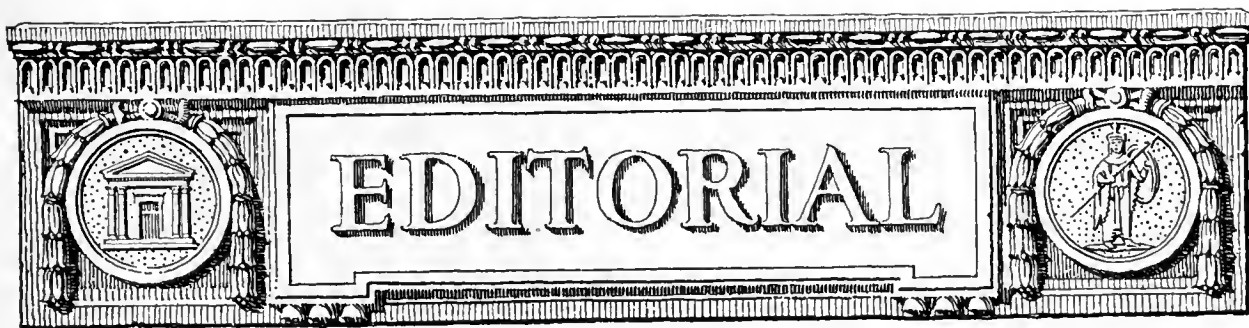

A Plain Duty

ATENTION has been directed to the well conducted propaganda by building contractors in the education of the public as to the necessity for speedy preparation to meet what is universally believed will be a pronounced building activity in the early Spring.

There are no good reasons why architects should submit to a monopoly in this valuable work. In fact, as the master builders, they should be the first to promote public confidence. There are no ethical obstacles to such a course. Architects may advertise. They cannot find a better or more dignified method of placing themselves before the public than by publishing over their signatures such carefully prepared and accurate statements as will tend to give the public the same confidence as to the future of building as every well informed architect will feel.

Why let the building contractors monopolize this desirable field?

A New Civic Center in New York

THE man on the street who has intimately known New York as man and boy for fifty years will find in the present rapid development of the Columbus Circle section much to make him reminiscent.

He will have seen the civic center start at Fourteenth Street, slowly move to Twenty-third Street, then jump to Forty-second where for the last fifteen years it has stopped. The buildings now in progress of erection or contemplated will create at the southeastern corner of Central Park an area of skyscrapers that will rival even that cluster whose magnitude calls forth the most enthusiastic remarks from the foreign visitor who approaches Manhattan Island from the sea.

The United States Rubber Building, the first of the tall buildings in the Columbus Circle section, built some six years ago, reared its twenty stories alone until within six months. Since then there has been built the twenty-four-story building for the Gotham

National Bank, there is nearing completion the equally tall building of the Fisk Tire Co. The Hearst building, now a preliminary structure of but two stories, will, it is rumored, be built up to its originally projected height of perhaps the tallest structure in the world.

Further, there is the announcement that on the block bounded by Fifty-seventh and Fifty-eighth Streets, Broadway and Eighth Avenue, now occupied by the Thoroughfare building, another twenty-four story building to be called the Colonnade will be erected.

Due to the wise restrictions of zoning regulations, all of these buildings with the exception of the United States Rubber Building, erected before the zoning law was passed, will be "set back" buildings, of the best architectural treatment. Now that there has been started a well developed plan for the creation of a civic center, it is to be hoped that in the erection of future structures the architectural resources may be carefully conserved and that New York will have a civic center which it may properly point to with pride.

Daylight Saving

THE action of the New York State legislature in repealing the daylight saving bill is not meeting with approval. Mr. William Fellows Morgan, president of the Merchants' Association of New York, has been outspoken in condemning the repeal of this measure. The consensus of opinion is that it is the result of petty politics and directly against the express wishes of the voters.

The poll taken by the Merchants' Association shows that 230,000 of the 241,000 workers in New York City favor daylight saving, and this overwhelming vote undoubtedly represents the sentiment all over the State. The issue as joined appears to be one as between the farmers and the workers in large cities. As the case stands, the matter will very seriously affect building in all of the large cities in this State.

Beaux-Arts Institute of Design

DIRECTOR OF THE INSTITUTE, LLOYD WARREN

ARCHITECTURE, RAYMOND M. HOOD
SCULPTURE, JOHN GREGORY

INTERIOR DECORATION, ERNEST F. TYLER
MURAL PAINTING, ERNEST C. PEIXOTTO

Official Notification of Awards— Judgment of November 16, 1920

PROGRAM

CLASS "A"—I PROJET.

The Committee on Architecture proposes as subject of this Competition:

"A COUNTRY HOUSE."

A successful and travelled American of hospitable nature finds on account of his increasing family that his early home is inadequate, and no longer attractive, due to business encroachments. He has, therefore, purchased a farm which he intends to develop into a country home for occupation during the entire year, except for a few months in midwinter, and even then during the holidays the house will be opened.

Together with a natural love of outdoor life and sports, both the owner and his family have a keen and varied interest in music and the arts, and their house and its surroundings should be developed accordingly. In particular, attention needs to be given to the proper accommodation, privacy and entertainment of the servants, for being at a distance from the attractions of the town, this is necessary in order to make the place desirable and to retain those of the better class.

The farm is situated in a wooded, hilly country and is traversed by a small river, whose upper reaches are well above the level of the area of development so that there is an ample water supply for all necessary purposes, including even a reasonable amount for use in the gardens.

The house is to be built on a sloping hillside, which rises to a great height north of the house, but falls away to the south, east and west, giving a splendid view in these directions. Approximately three (3) acres, or one hundred and thirty thousand (130,000) square feet of land are available for the development in direct connection with the house.

The problem requires the arrangement of the residence and grounds in a manner suitable to the circumstances of the family as before indicated, but does not include the farm development, garage, stables, service buildings, etc., which are outside of the limits of the area described above.

The house should be airy and cheerful and should provide for about twelve (12) masters' bedrooms, which may be on upper floors, and ample accommodations for service. Besides the other usual features of such a large house, the owner wishes to have a great hall or music room which, in conjunction with the other principal rooms, forms an ensemble suitable for entertaining on a lavish scale, and also a swimming pool.

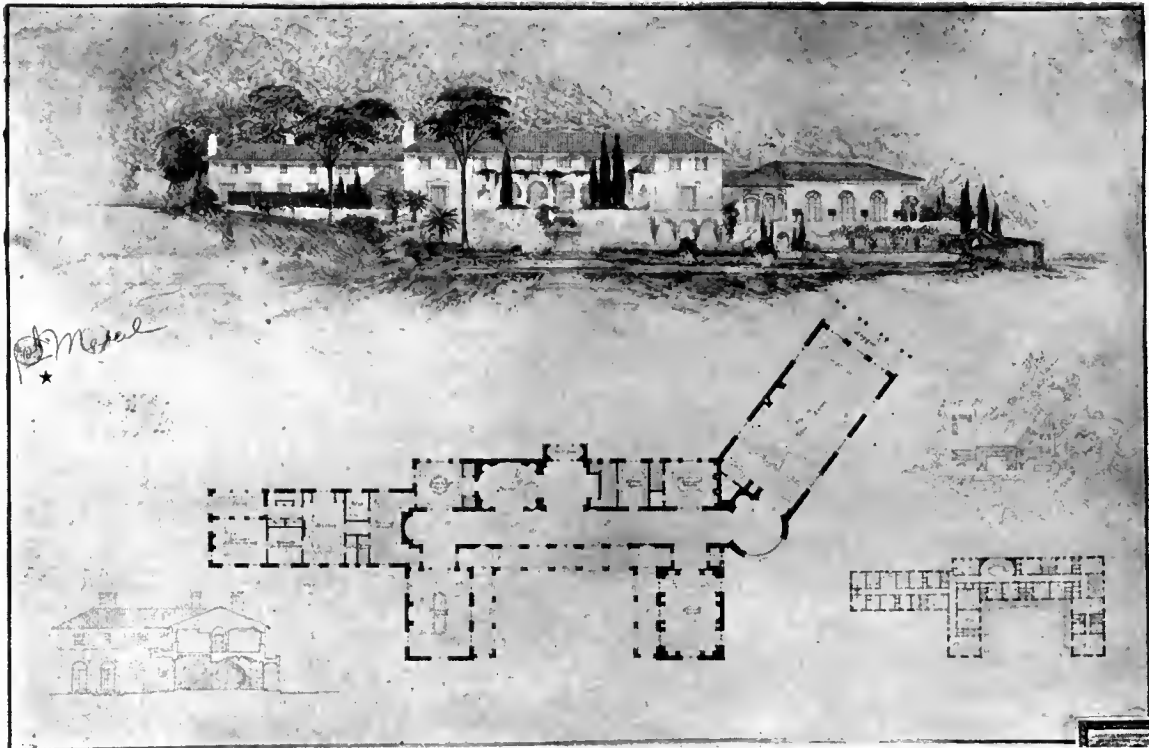

1st MEDAL

F. K. DRAZ,

CARNEGIE INSTITUTE OF TECHNOLOGY

CLASS "A"—I PROJET—A COUNTRY HOUSE

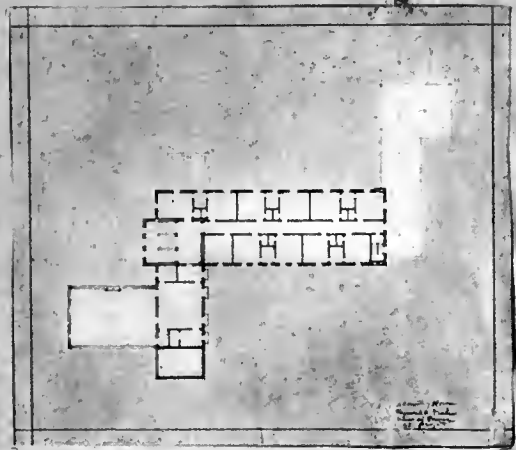
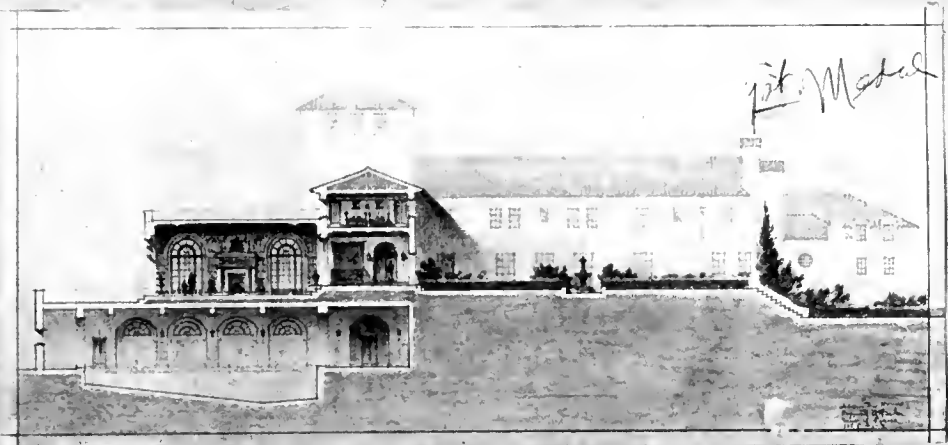
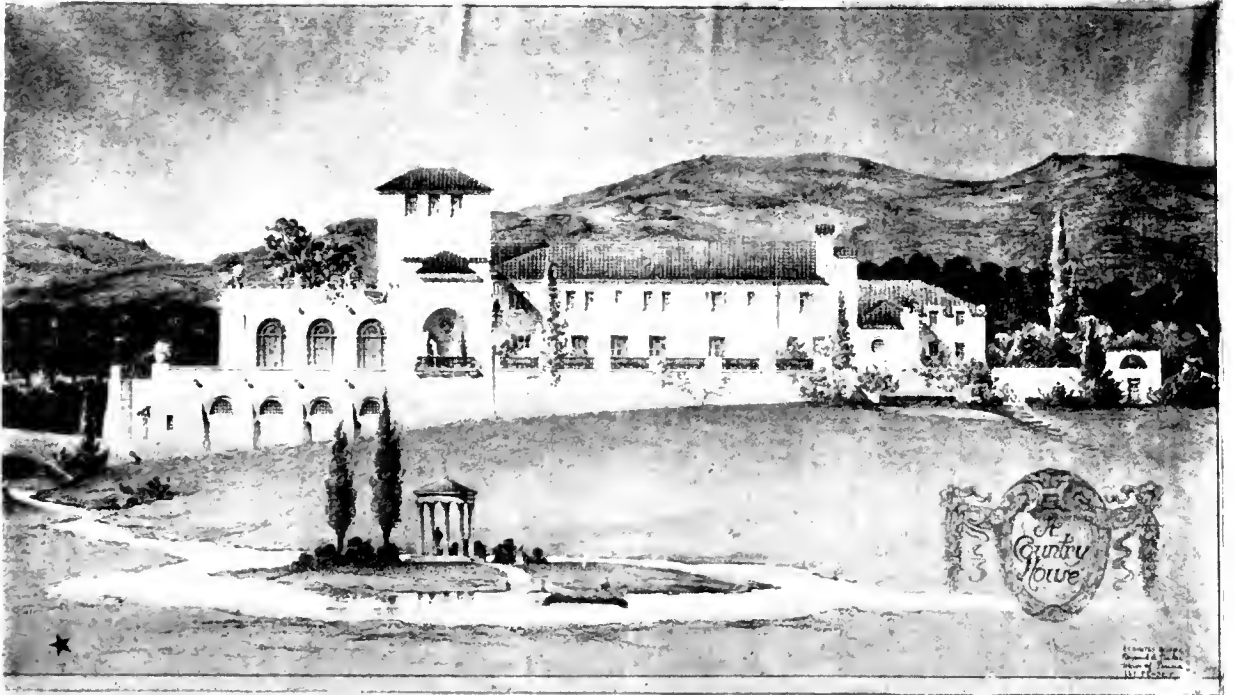

1st MEDAL

R. A. FISHER,
CLASS "A"-1 PROJET—A COUNTRY HOUSE
STUDENT WORK - BEAUX-ARTS INSTITUTE OF DESIGN

UNIVERSITY OF PENNSYLVANIA

THE AMERICAN ARCHITECT

This latter feature may be in a detached pavilion in the gardens surrounding the house, or in a part of the house.

JURY OF AWARD:

R. M. Hood, L. Warren, H. R. Sedgwick, B. W. Morris, E. V. Meeks, H. Hornbostel, J. M. Howells, H. W. Corbett, P. P. Cret and S. Walker.

NUMBER OF DRAWINGS SUBMITTED: 85

AWARDS:

First Medal: F. K. Draz and H. T. Aspinwall, Car-

negie Inst. of Tech., Pitts.; R. H. Bickel, Columbia Univ., N. Y. C.; R. Nickel, "T" Square Club, Phila.; R. A. Fisher, R. F. Larson and R. S. Potter, Univ. of Pennsylvania, Phila.; R. B. Thomas, Yale Univ.-Sch. of Fine Arts, New Haven.

Second Medal: L. J. Rockwell, B. Dierks and C. W. Hunt, Carnegie Inst. of Tech., Pitts.; G. W. Trofast-Gillette, Columbia Univ., N. Y. C.; T. M. Hofmeister, Jr., Chic. Sch. of Archt.-Dept. of Archt. of Armour Inst. of Tech., Chic.; E. C. K. Schmidt and H. R. Leicht, "T" Square Club, Phila.; D. R. Cochran, G. K. Trautwein, L. H. Pries, E. O. John, K. A. McGrew, G. K. Geerlings and S. J. Laschenski, Univ. of Pennsylvania, Phila.; P. Jensen, Atelier Wynkoop, N. Y. C.

Mention: H. A. Wieland, R. E. Dake, N. D. Kutchukian, C. LeRoy DePrefontaine, L. S. Lashmit, H. W. Smith, R. M. Crosby, P. F. Simpson, E. A. Earley, S. H. Jamison, R. Schmertz, W. Perkins and M. Pohlmeier, Carnegie Inst. of Tech., Pitts.; M. L. Colean, S. M. Clement, C. H. Sherwood, E. Kasin, E. W. Burkhardt, D. R. Everson, F. W. Brown, J. G. Schulmann, Jr., A. W. Bitterman, R. S. Buck, Jr., R. W. Craton, B. E. Irby and L. G. Noyes, Columbia Univ., N. Y. C.; I. L. Loehl, Helen L. Fassett, G. D. Conner, N. J. Schlossman, R. J. Nedved, M. F. Winiarski, and A. J. Schoening, Chic. Sch. of Archt.-Dept. of Archt. of Armour Inst. of Tech., Chic.; R. DeGhetto and M. Jaeger, Jr., Atelier Hiron, N. Y. C.; R. L. Conn, Atelier Corbett-Gugler, N. Y. C.; R. L. Goldberg, R. Platt, A. Westover, Jr., and H. S. Atkinson, "T" Square Club, Phila.; G. W. Green and S. J. Laschenski, Univ. of Pennsylvania, Phila.; L. F. Soxman and W. M. Icehower, Univ. of Kansas, Lawrence; T. F. Price, R. Banwell and E. F. Cullity, Atelier Wynkoop, N. Y. C.; L. Hamilton, Yale Univ.-Sch. of Fine Arts, New Haven.

H. C.: A. M. Browde, W. C. Sponholz, F. M. Baldwin and R. L. Minkus, Chic. Sch. of Archt.-Dept. of Archt. of Armour Inst. of Tech., Chic.; W. S. Boice, Atelier Hiron, N. Y. C.; G. A. Barry, Univ. of Pennsylvania, Phila.

CLASS "A"—I ESQUISSE-ESQUISSE

The Committee on Architecture proposes as subject of this Competition:

"A GROUP OF BUILDINGS FOR A BOYS' BOARDING SCHOOL."

A successful design for a group plan of this kind is a happy compromise between conflicting conditions and desires. The buildings or units should be separated enough so as to have plenty of air and light for each, and at the same time they should have easy and close communication. There should be a certain internal privacy for the school life, giving freedom from the noise and distraction of the public streets, but there must be no feeling of an asylum. While the arrangement should be orderly, it should partake rather of a domestic than of a formal character.

The site is a level rectangular plot bounded by four attractively shaded streets on the outskirts of a large city in the middle west. Its dimensions are 320 feet east and west and 640 feet north and south. The main street and natural approach is along the south side of the plot. The athletic field of the school is on the opposite side of the street, east of the school site. The school is limited to 300 pupils, who will live inside the group and no day scholars are contemplated. It is not a secular school, so the chapel need not dominate the composition.

The following requirements shall be arranged either in separate or attached units, as desired:

The Main School (including Administration, Library, Study Hall and Class Rooms). This may be disposed on two or three floors.

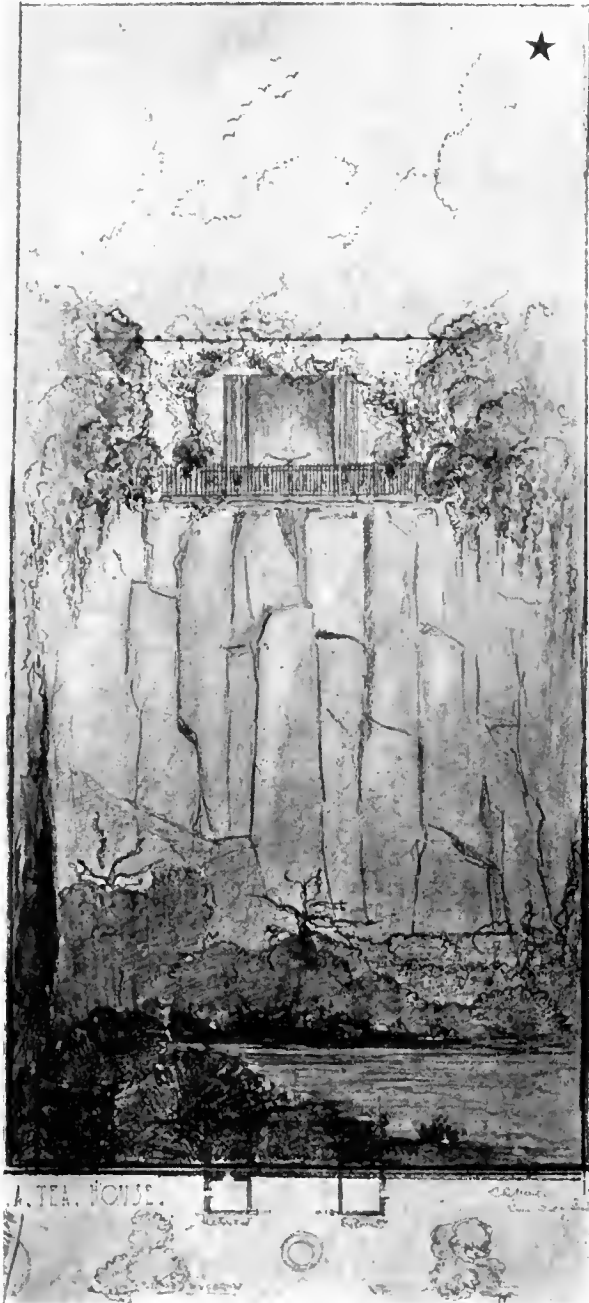

1st MENTION—C. B. MARKS, CARNEGIE INSTITUTE
CLASS "B"—I—ESQUISSE-ESQUISSE
A STONE TEA HOUSE IN A PRIVATE PARK

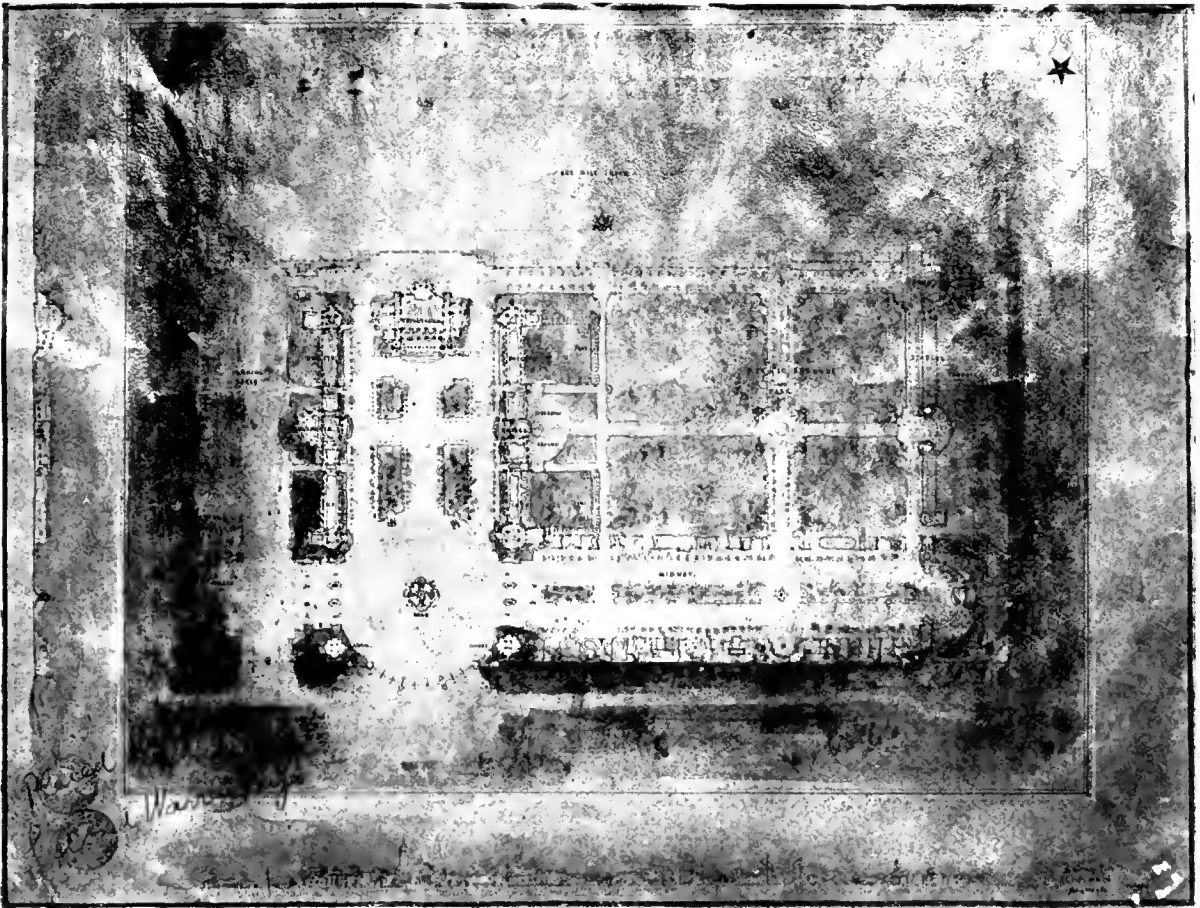

SECOND PRIZE PLACED THIRD

E. L. HOWARD,

NEW YORK CITY

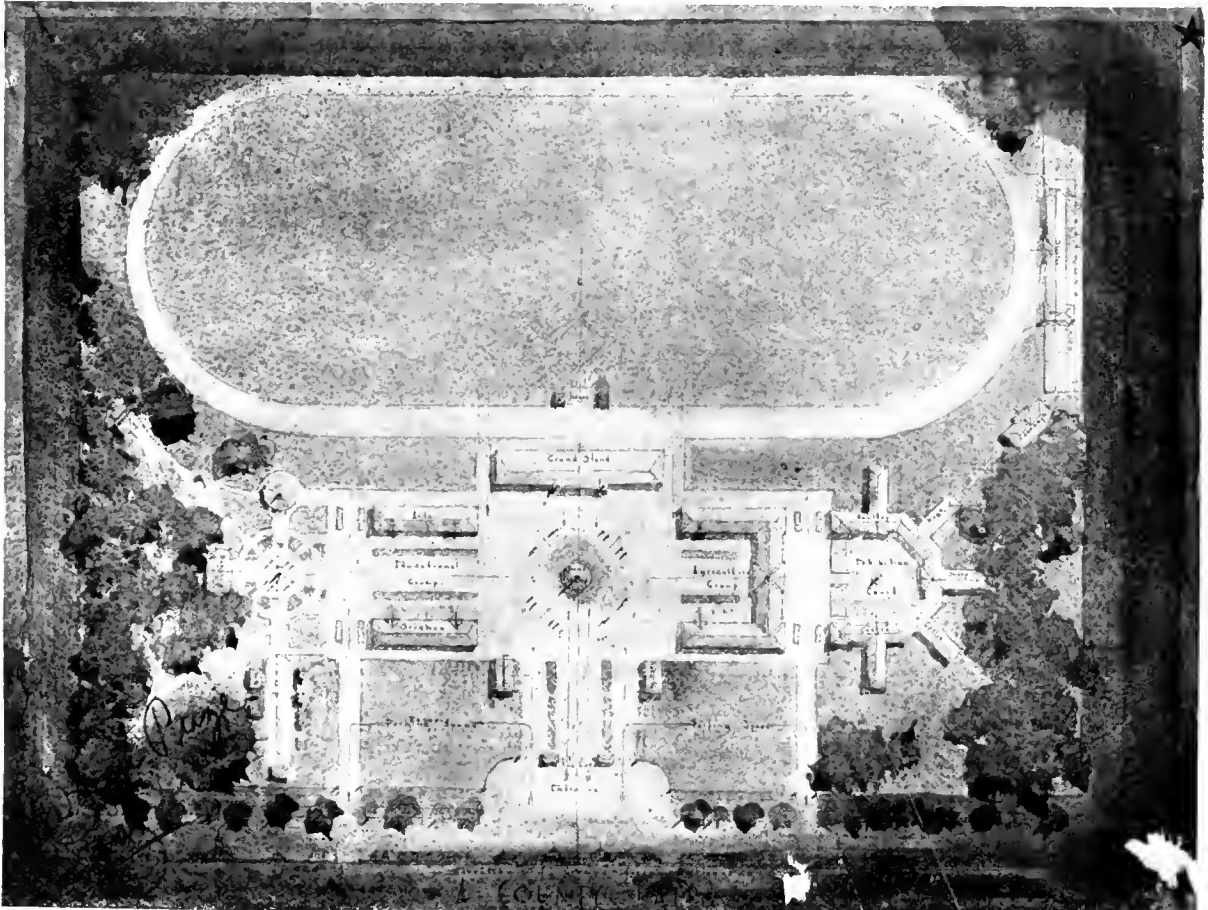

FIRST PRIZE

V. S. SWAN,

CORNELL UNIVERSITY

WARREN PRIZE COMPETITION—A COUNTY FAIR
STUDENT WORK—BEAUX-ARTS INSTITUTE OF DESIGN

THE AMERICAN ARCHITECT

The Headmaster's House with a garden adjoining.
 A Chapel to seat 400.
 Dormitories with apartments for four married masters, so placed as to properly control the students. These dormitories may be on two or three floors.
 A Dining Hall (to seat 350) with kitchen and other necessary services.
 A Large Gymnasium (including a swimming pool).
 A Power House and Laundry.

JURY OF AWARD:

W. F. Lamb, J. O. Post, P. A. Cusachs, H. Greenley, F. C. Hirons, L. F. Peck, J. Wynkoop and E. H. Denby.

NOTE:

This Jury also served as Jury of Award for the Class "B"—I Esquisse-Esquisse, and Class "A" and "B" Archaeology—I Projet.

NUMBER OF DRAWINGS SUBMITTED: 31

AWARDS:

Third Medal: T. E. Ash, "T" Square Club, Phila.; R. F. Larson, Univ. of Pennsylvania, Phila.
 Mention: G. Fraser, Cornell Univ., Ithaca; G. K. Gerlings, Univ. of Pennsylvania, Phila.

PROGRAM

CLASS "B"—I ESQUISSE-ESQUISSE

The Committee on Architecture proposes as subject of this Competition:

"A STONE TEA HOUSE IN A PRIVATE PARK."

The gardens of a large estate consist, beside the usual formal grounds and terraces in close proximity to the house, of a large tract of picturesque woodland, which, while kept up, has been left largely in its natural form. The owner wishes to erect, in a glade traversed by a small stream, a stone tea house to provide rest and refreshment to those who are walking or driving through his park. He has no determined idea as to the form this tea house should take, except that it should be appropriate to its setting and should provide a small room for the preparation of simple refreshments and for the storage of the necessary service. The greatest dimension of the tea house should not exceed thirty (30) feet.

NUMBER OF DRAWINGS SUBMITTED: 53

AWARDS:

First Mention: C. B. Marks, Caruegie Inst. of Tech., Pitts.; A. Marshall and C. H. Dornbusch,

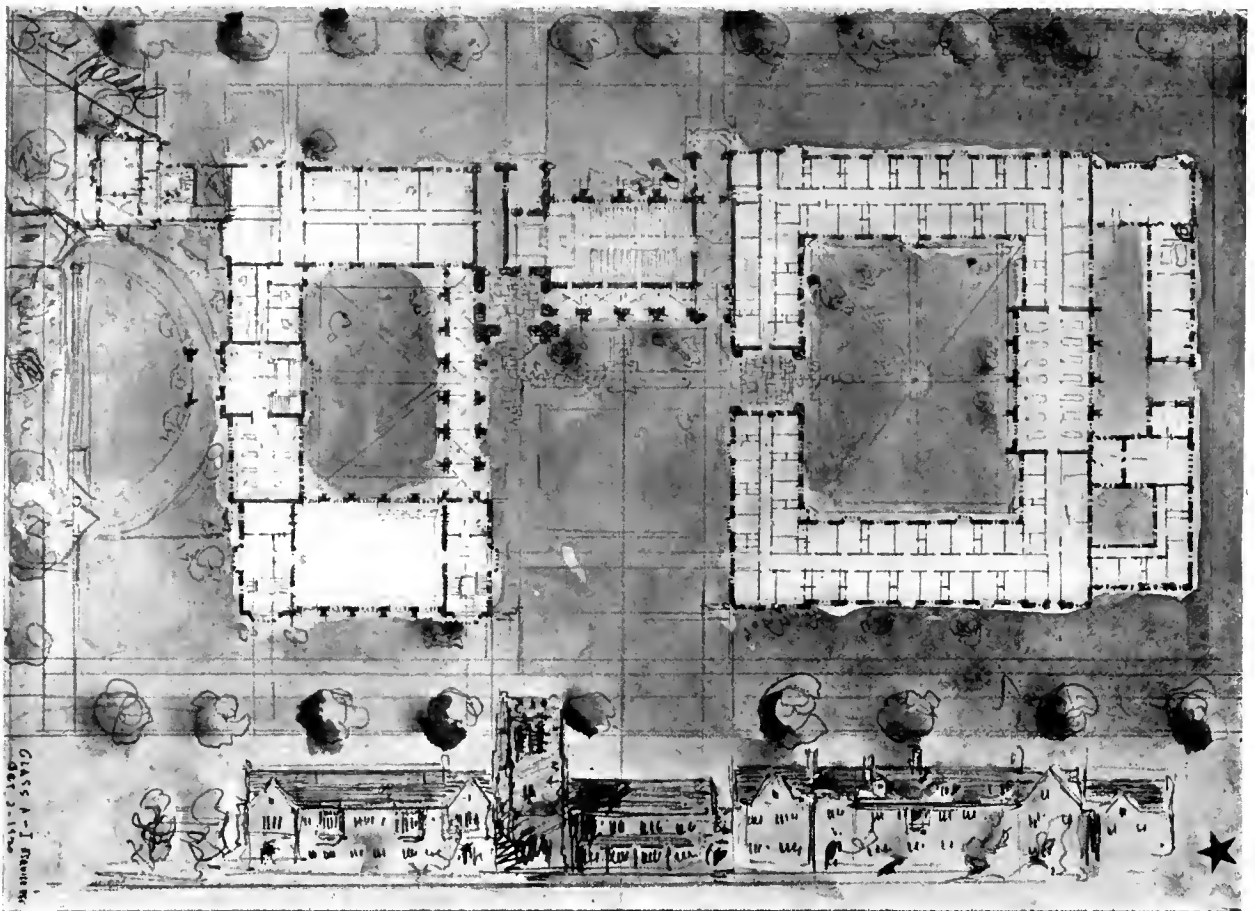

CLASS "A"—I. ESQUISSE-ESQUISSE

A GROUP OF BUILDINGS FOR A BOYS' BOARDING SCHOOL

3d MEDAL

R. F. LARSON,

UNIVERSITY OF PENNSYLVANIA

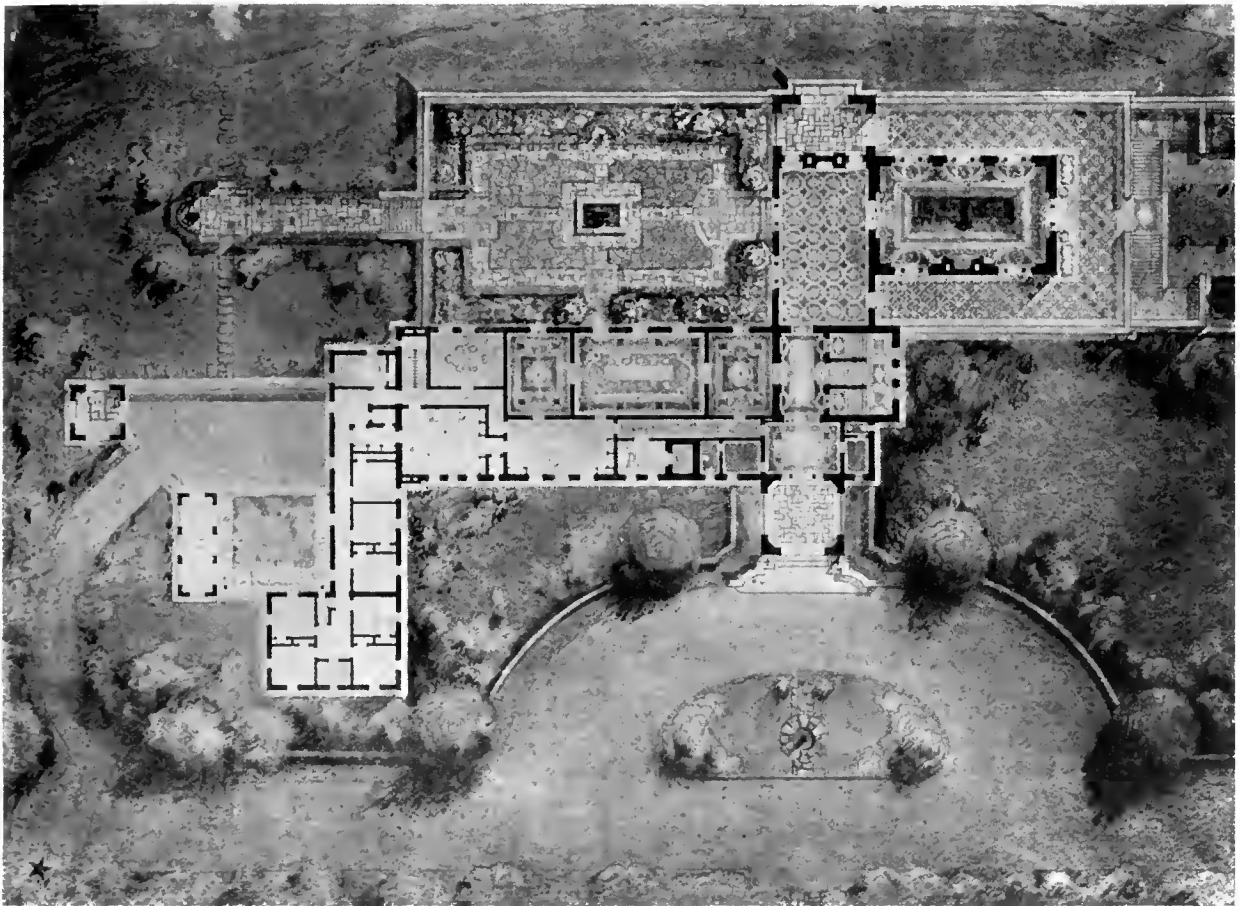

1st MEDAL

R. A. FISHER,

UNIVERSITY OF PENNSYLVANIA

CLASS "A"-1 PROJCT—A COUNTRY HOUSE

Columbia Univ., N. Y. C.; G. A. Hacker, Atelier Sibley, Palisade; H. S. Kelly, Yale Univ.-Sch. of Fine Arts, New Haven.

Mention: M. E. Witmer, Boston A. C., Boston; H. B. Tross, Buffalo A. C., Buffalo; J. W. Minick and S. Jamison, Carnegie Inst. of Tech., Pitts.

CLASS "A" AND "B" ARCHAEOLOGY—I PROJCT.

The Committee on Architecture proposes as subject of this Competition:

"THE FORECOURT OF AN EGYPTIAN TEMPLE."

Religious fervor and reverence for the dead are the most important characteristics of the ancient Egyptians which found expression in the architecture of the Nile Valley. Their temples, built for all time, were not intended for public gatherings, but were the houses of the priests and the places of worship for the kings. In its essential features the plan of the Egyptian temple consisted of a forecourt, a hypostyle hall and the sanctuary with the adjoining priests' rooms—the whole being surrounded by a massive exterior wall. The entrance from the forecourt to the hypostyle hall was usually flanked by huge pylons or colonnades. Here a splendid feeling of grandeur was obtained through the simplicity and solidity of the architecture, the stone surfaces of which were relieved by surface carving and a lavish use of color.

The subject of this competition is the design of the

forecourt and the entrance to the hypostyle hall. The extreme width of the forecourt shall not exceed 100 feet. Its length is not limited.

NUMBER OF DRAWINGS SUBMITTED: 4

AWARDS:

Third Medal: M. L. Keller, Columbia Univ., N. Y. C.; H. C. Heath, Univ. of Texas, Austin.

Mention: G. L. Walling, Univ. of Texas, Austin.

THE WARREN PRIZE.

The gift of Messrs. Whitney Warren and Lloyd Warren offered for excellence in planning a group of buildings.

FIRST PRIZE—\$50. SECOND PRIZE—\$25.

(For conditions governing this Prize Competition see Circular of Information, Article VIII—Par. 1 and 3.)

The Committee on Architecture proposes as subject of this Competition:

"A COUNTY FAIR."

On the outskirts of a county seat on a tract of land measuring 1,800 by 2,500 feet, the County Fair Association desires to establish its fair grounds, which are to include the following elements:

1. A One Mile Race Track with the necessary grandstands, paddock and stables.
2. The Exhibition Building or Buildings for cattle,

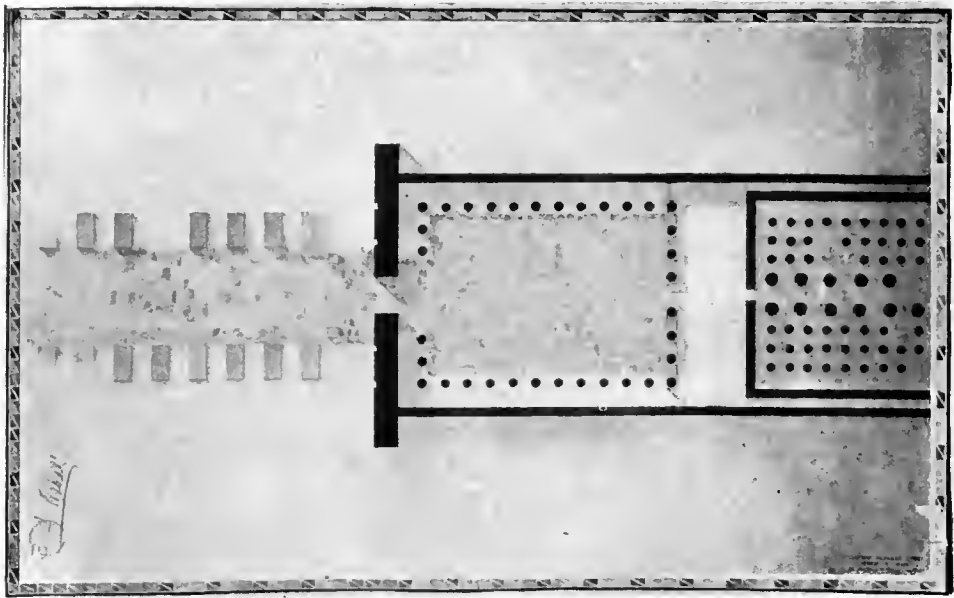

FLOOR PLAN, FORECOURT OF AN EGYPTIAN TEMPLE

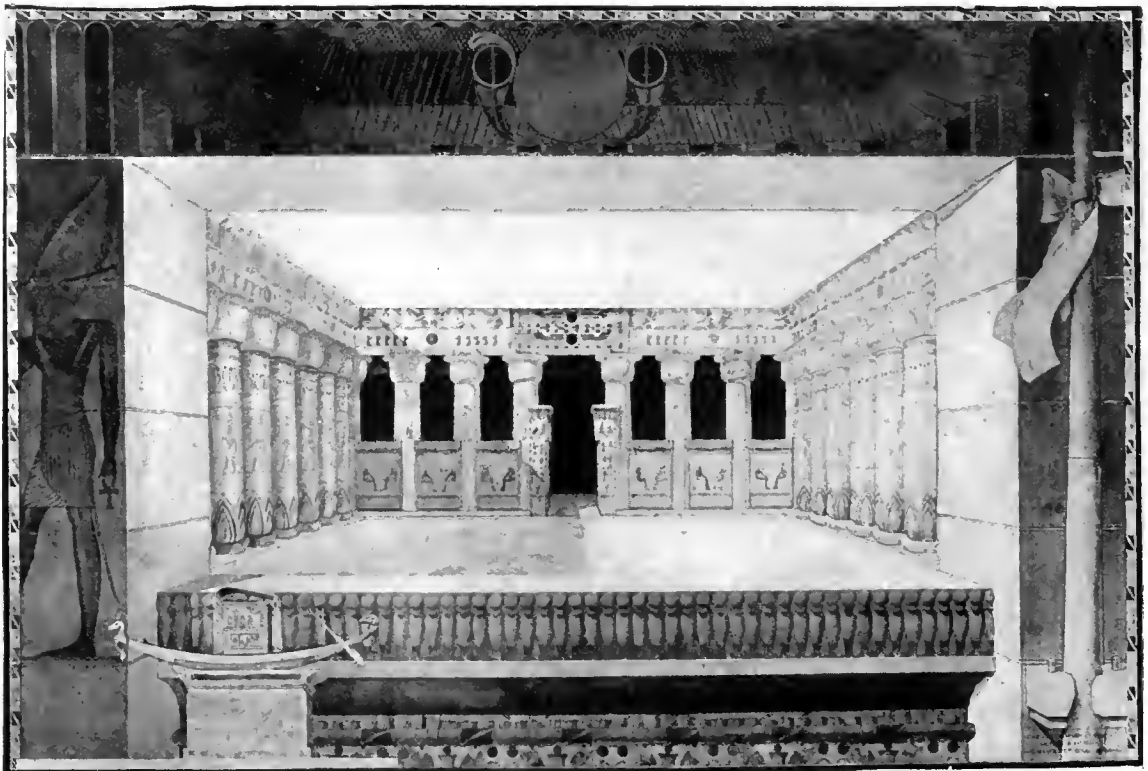

3d MEDAL

H. C. HEATH,

UNIVERSITY OF TEXAS

CLASS "A" AND "B"-ARCHAEOLOGY-1, PROJCT
FORECOURT OF AN EGYPTIAN TEMPLE

pigs, poultry and other forms of livestock. In connection with this group, which in general should be so arranged that the various breeds and classes can be exhibited separately, there should be provided an open space for the judging of the animals and the awarding of prizes.

3. The Agricultural Group, which is to provide facilities for the exposition of all sorts of produce.

4. The Educational Exhibit, embracing domestic science, scientific farming, art and other phases of education.

5. The Amusement Group or Midway, in which will be found merry-go-rounds, moving-picture theatres, refreshment booths and all sorts of catch penny devices.

In the study of this plan, the control of large crowds, both on foot and in automobiles, especially at the entrances, should be carefully considered. Parking spaces for autos should be provided within the grounds, and the circulation everywhere should be

ample, and, as far as possible, direct and convenient. The entrances from a main road bordering one side of the property should be adequate in view of the continual ingress and egress during the day.

JURY OF AWARD:

R. M. Hood, W. F. Lamb, J. W. Cross, P. A. Cusachs, J. O. Post, H. Greenley, J. M. Howells and E. H. Denby.

NUMBER OF DRAWINGS: 44

AWARDS:

First Prize (\$50.00): V. S. Swan, Cornell Univ., Ithaca.

Placed Second. (Not qualified for money prize): G. Fraser, Cornell Univ., Ithaca.

Placed Third. (Second Prize \$25.00): E. L. Howard, care H. Van B. Magonigle, N. Y. C.

Placed Fourth: J. P. Morgan, Pittsburg A. C., Pitts.

Placed Fifth: F. H. Robinson, Cornell Univ., Ithaca.

The American Specification Institute

Correspondents Continue the Discussion Favoring the Organization

All information which has been published in reference to the American Specification Institute has been read with much interest, and there is undoubtedly a great field which is to be covered by such an organization. Since the architectural schools of the country are all interested in the education of the young architect, I would like to see some provision made in your constitution whereby the schools of architecture may receive the benefit of your deliberations.

One statement in the editorial appearing November 17 states that, "In our architectural schools, in the ateliers and in the various courses given, instruction in specification writing has been neglected to such an extent that those to whom the task of specification writing has fallen have usually been forced to educate themselves." This statement is not true of the work offered at the University of Illinois, as there is a course offered to seniors in construction of specifications.

Our method of presentation of this subject to the students might be very much improved, but we are spending considerable time and making a conscientious effort to drill in the minds of the students that the writing of specifications demands very serious consideration. Our Department of Architecture would welcome any information which is prepared by the Institute, and it is hoped that it may be able to organize and carry out the work as indicated.

Having for about ten years been interested in writing specifications and interpreting architects'

specifications, there is no question but that a great deal of standardization can be effected. I realize that it is impossible to write a specification which would apply to every building, but there are certain fundamental requirements which could be outlined rather completely which would be of great service to the specification writer.

As you know, there are certain standard forms already in existence, and the American Institute of Architects has its Structural Service Bureau, but the whole subject of specifications is so broad that the proposed Institute need not duplicate any of the good work which has been or is being done. With the constantly changing conditions in the way of new building materials, new methods of application, new devices, etc., for all building work, the Institute has a great work before it in keeping up on all of this latest information and distributing such information to the members or those who are entitled to receive the information from the Institute.

I teach the specification work in our department and I will welcome any standardization which the Institute finds possible to make.

A specification writer cannot be efficient and spend all or most of his time in the drafting room or office. He must be a man of practical experience and one who keeps in touch with modern methods of construction.

L. H. PROVINE,
Urbana, Ill. Department of Architecture,
University of Illinois.



HOUSE OF CYRIL CRIMMINS, NOROTON, CONN.

RAYMOND M. HOOD, ARCHITECT

By the use of the ample portico with its slender posts the architect has succeeded in transforming a rather commonplace facade into something arresting and adequate to its beautiful setting.



INTERIOR VIEW OF BATHING PAVILION

A House-Boat in the Woods

The fact that architecture is, for the most part, a serious affair does not mean that it may not have its playful expressions. Mr. Crimmins' house-boat is, in spite of its unusual design, a practical pavilion for the entertainment of his friends. The swimming pool is a highly important part of the scheme, and its location immediately adjacent to the large entertainment room is interestingly and decoratively treated. That the pavilion is designed in the likeness of a ferry-boat is an amusing variation from the usual run of things, but the whim of the owner is quite justified by the architect's successful interpretation of his conception.

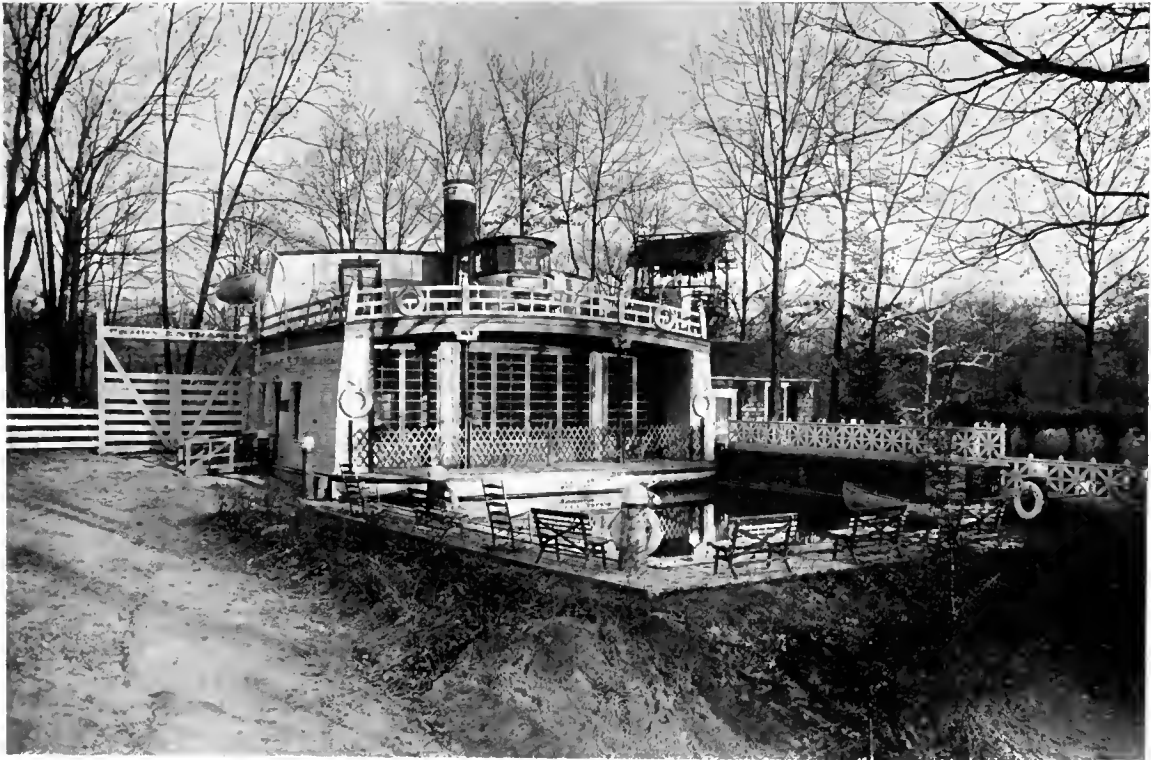

BATHING PAVILION AND SWIMMING POOL
ESTATE OF CYRIL CRIMMINS, NOROTON, CONN.
RAYMOND M. HOOD, ARCHITECT

THE AMERICAN ARCHITECT

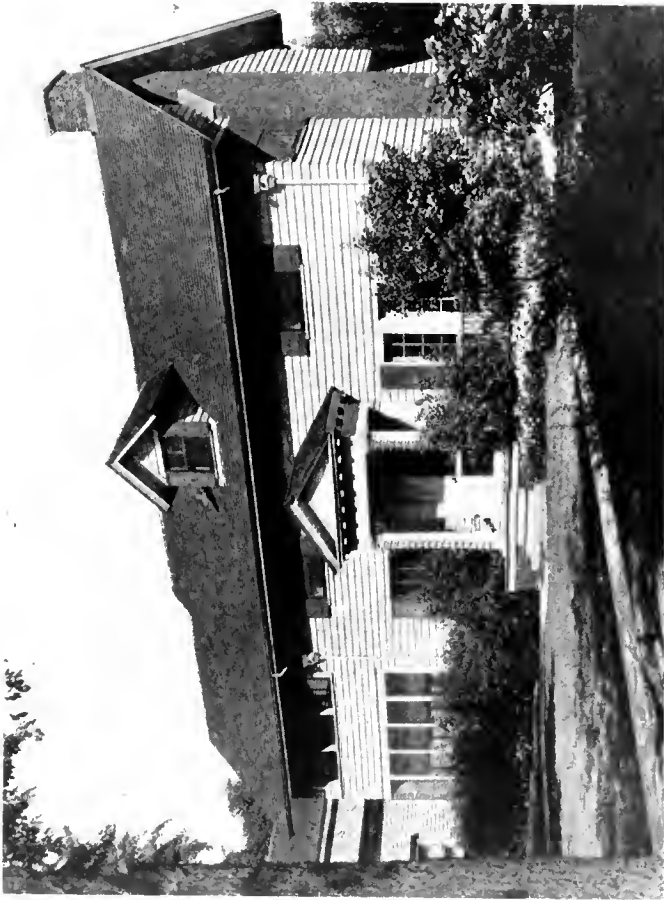

HOUSE OF C. D. BARNES, KENOSHA, WIS.
N. MAX DUNNING, ARCHITECT



ENTRANCE DETAIL

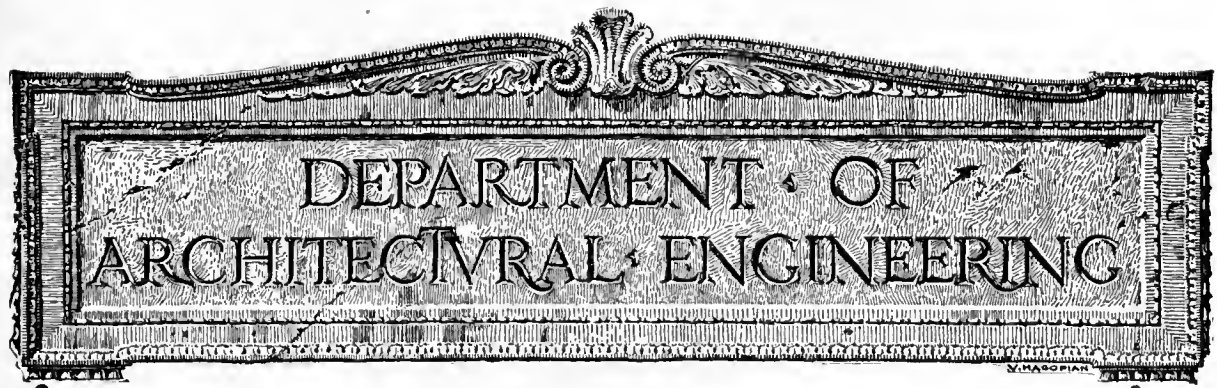

New Design Data for Cement Slabs

Recent Information Obtained from Tests at Lehigh University on Slabs Poured with Mixture Under Pressure from a Nozzle

THE method of pouring cement slabs by shooting the mixture of sand and cement into the forms under pressure has recently developed to a point where accurate design data has been obtained for figuring the strength of such slabs.

Tests have been conducted under the personal supervision of M. O. Fuller, Adjunct Professor of Civil Engineering at Lehigh University, and George E. Strehan, Consulting Engineer, who has developed the slab formulas now accepted as standard by the Building Department of New York City. Many suggestions were received from experts who witnessed the breaking of the slabs and the results have been submitted to and approved by them.

One feature of these tests was that the same conditions controlled the manufacture of the specimens in

the laboratory as control actual construction work in the field. It is common practice, in testing poured concrete or hand-placed mortars, to be particular in selecting, grading, proportioning and mixing the materials. Care is also exercised in protecting or "curing" concrete laboratory test specimens. The materials entering into the slabs used in these tests were such as are ordinarily met with on good construction work. The sand used was "bank sand" from Succasunna, N. J., and was pumped into cars from under water. It was given no further treatment. The cement consisted of equal parts of four standard brands. The expanded metal reinforcement used was a standard obtainable at any time in the open market. The "shooting" of the slabs was performed by several different members of the Cement

TABLE I

SERIES A 4' span—5' width n=10 1-2½ mix										
Slab No.	Wt. per ft. of Width	Applied Breaking Load per ft. of width	Total Load per ft. of width	B. M.	Eff. Dept	% Steel	k	j	fs	fe
7	109	632	741	4446	1.625	.66	.303	.899	23000	1030
11	109	596	705	4230	1.625	.66	.303	.899	22500	985
18	109	715	824	4944	1.625	.66	.303	.899	26200	1150
15	110	695	805	4830	1.625	.714	.313	.896	21900	1080
19	110	745	855	5130	1.625	.714	.313	.896	23900	1150
20	110	795	905	5430	1.625	.714	.313	.896	24700	1220
8	111	875	986	5916	1.625	.904	.344	.886	23300	1220
9	111	835	946	5676	1.625	.904	.344	.886	23400	1170
10	111	692	803	4818	1.625	.904	.344	.886	19000	998
1-3 mix										
4	109	492	601	3606	1.625	.66	.303	.899	19100	837
5	109	600	709	4254	1.625	.66	.303	.899	22600	990
6	109	609	718	4308	1.625	.66	.303	.899	22800	1000
12	110	697	807	4842	1.625	.714	.313	.896	22000	1090
13	110	580	690	4140	1.625	.714	.313	.896	18800	933
14	110	587	697	4182	1.625	.714	.313	.896	19000	943
1	111	825	936	5616	1.625	.904	.344	.886	22100	1160
2	111	686	797	4782	1.625	.904	.344	.886	18900	989
3	111	790	901	5406	1.625	.904	.344	.886	21300	1110

THE AMERICAN ARCHITECT

Gun Company's staff of operators at different times.

The exact amount of water for proper hydration of the cement was automatically controlled. If insufficient water is used, the too dry material is blown away and lost; and if too much is used the cement will not run and will not adhere, especially on vertical or ceiling work. When cement is poured in this way there is no advantage to be gained by the nozzle man in the use of an excessive amount of water as is the case in hand placed mortars where ease in finishing is desired.

The forms consisted of two concrete blocks with a cribbing blocked up on a shelf in the blocks, a steel plate on top of the cribbing and building paper over the steel plate. Strips were laid along the steel plates at the ends to give the desired thickness.

Cement and sand were mixed dry, screened through a $\frac{3}{8}$ " square mesh and supplied to the gun hopper. The slabs were shot into the forms in one operation, the air pressure 20-22 lbs. per

Method of placing bars and rollers for applying loads

sq. in., and the water pressure 50-60 lbs. per sq. in.

Two 3" x 7-16" x 5' steel plates were laid in gypsum at the third points of the span, 2 $\frac{1}{4}$ " diameter rollers placed thereon, and then a wooden platform rested on the rollers. Pig iron was weighed and placed on the platform, the successive layers being at right angles to each other.

All slabs were loaded without interruption to complete rupture, except two which will be described further on. The slabs were loaded at 1/3 and 2/3 span by using steel bars imbedded in gypsum supporting steel rollers which in turn supported the loading platform. Pig iron was used and applied in increments of approximately 500 lbs. by hand in order to simulate ordinary handling of one-man weights in the average factory or warehouse. Deflections were read at each increment in loading. Proper care was exercised to detect the appearance of cracks; and

these were closely watched during the remainder of the test.

The two exceptions above referred to were slabs Nos. 27 and 40. Slab No. 27 (3'-9" wide with span of 6 ft. and 2 $\frac{1}{2}$ in. thick, with 11.33 per cent. of reinforcement) was loaded to 368 lbs. per sq. ft., the deflection at that time being 7/16 in. This load was left on the slab for seven days at which time the deflection had increased to nearly 5/8 in. The loading of the slab was then resumed and it broke under a load equivalent to 870 lbs. per sq. ft. The peculiarity noted was that the deflection curve on the second loading was parallel to the first loading.

Slab No. 40 (4' wide with clear span of 8 ft. 3 $\frac{1}{2}$ in. thick, with 1.69 per cent. of reinforcement) was loaded May

Reinforcement and Supporting Panel in place between concrete supports

8, 1920 (when 29 days old) to 440 lbs. per sq. ft. This was practically the yield point of the steel. Microscopic cracks appeared at the center and under both rollers. An examination of this slab after 185 days showed the deflection had increased to 2 1/16 in.;

Platform on top of rollers before load was applied

that the cracks had not increased; and, that no further cracks had

appeared. The effective depth of this slab was 2 $\frac{1}{2}$ in.

These slabs were built and tested as simple beams. In calculating slab values the ratio of the moduli of elasticity was taken as 10, based upon the report of the Joint Committee for values of concrete of over 4,000 lbs. compressive strength, and these tests definitely showed that a mixture of one part Portland cement to three parts sand applied in this way in slabs can be assumed to have a factor of safety of 4 when stressed to 1,500 lbs. per sq. in. A 1:2 $\frac{1}{2}$ mixture has a factor of safety of 4 when stressed to 1,800 lbs. Actually, these factors of safety are 4.16 and 4.85 respectively.



THE AMERICAN ARCHITECT

Translated into floor thickness, these values show extremely interesting facts. For instance, such floors may be constructed of only one-half the thickness of concrete floors, to support the same load. This effects great economy in labor and materials, in the construction of floors, roofs and side walls.

But this effect goes further. The reduction of dead load due to the decrease in floor weights, is

The fireproof qualities of this method of pouring have been tested by the Underwriter's Laboratory for wall construction. The wall was built by setting up form panels consisting of light wooden frames covered with tar paper, so spaced that a recess of 6 in. was left between adjacent panels. In this recess were set up two reinforcing rods tied together, to which the reinforcing mesh was fastened on both

TABLE II

SERIES B											
Mix 1-3 Span 6 ft. width 3 ft. 9 in.											
Slab No.	Wt. per ft. of Width	Applied Breaking Load per ft. of width	Total Load per ft. of width	R. M.	Def. Dist.	% Steel	k	l	fs	fc	
29	181	319	703	1827	1.873	618	325	300	2250	1120	
30	174	328	611	3308	1.623	714	313	300	2250	1400	
31	162	335	541	4925	1.4313	797	300	300	2250	1300	
32	156.6	330	953	8391	1.375	1.11	300	300	2250	1250	
33	150.6	330	953	8134	1.3623	1.14	300	300	2250	1190	
34	147	330	1006	8118	1.3523	1.14	300	300	2250	1400	
35	147	330	1071	8367	1.3423	1.14	300	300	2250	1300	
36	147	330	1313	13617	1.212	1.33	300	300	2250	2140	
37	147	330	1071	8333	1.3323	1.14	300	300	2250	1510	
38	143	330	1071	8288	1.3223	1.14	300	300	2250	1170	
39	135	330	1412	13117	1.2023	1.33	300	300	2250	1370	
40	125	330	1019	13117	1.2023	1.33	300	300	2250	1370	
41	125	330	1019	13117	1.2023	1.33	300	300	2250	1370	
42	124	330	1019	13117	1.2023	1.33	300	300	2250	1370	
43	124	330	1019	13117	1.2023	1.33	300	300	2250	1370	
44	124	330	1019	13117	1.2023	1.33	300	300	2250	1370	
45	124	330	1019	13117	1.2023	1.33	300	300	2250	1370	
46	124	330	1019	13117	1.2023	1.33	300	300	2250	1370	
47	124	330	1019	13117	1.2023	1.33	300	300	2250	1370	
48	124	330	1019	13117	1.2023	1.33	300	300	2250	1370	
49	124	330	1019	13117	1.2023	1.33	300	300	2250	1370	
50	124	330	1019	13117	1.2023	1.33	300	300	2250	1370	
51	124	330	1019	13117	1.2023	1.33	300	300	2250	1370	
52	124	330	1019	13117	1.2023	1.33	300	300	2250	1370	
53	124	330	1019	13117	1.2023	1.33	300	300	2250	1370	
54	124	330	1019	13117	1.2023	1.33	300	300	2250	1370	
55	124	330	1019	13117	1.2023	1.33	300	300	2250	1370	
56	124	330	1019	13117	1.2023	1.33	300	300	2250	1370	
57	124	330	1019	13117	1.2023	1.33	300	300	2250	1370	
58	124	330	1019	13117	1.2023	1.33	300	300	2250	1370	
59	124	330	1019	13117	1.2023	1.33	300	300	2250	1370	
60	124	330	1019	13117	1.2023	1.33	300	300	2250	1370	
61	124	330	1019	13117	1.2023	1.33	300	300	2250	1370	
62	124	330	1019	13117	1.2023	1.33	300	300	2250	1370	
63	124	330	1019	13117	1.2023	1.33	300	300	2250	1370	
64	124	330	1019	13117	1.2023	1.33	300	300	2250	1370	
65	124	330	1019	13117	1.2023	1.33	300	300	2250	1370	
66	124	330	1019	13117	1.2023	1.33	300	300	2250	1370	
67	124	330	1019	13117	1.2023	1.33	300	300	2250	1370	
68	124	330	1019	13117	1.2023	1.33	300	300	2250	1370	
69	124	330	1019	13117	1.2023	1.33	300	300	2250	1370	
70	124	330	1019	13117	1.2023	1.33	300	300	2250	1370	
71	124	330	1019	13117	1.2023	1.33	300	300	2250	1370	
72	124	330	1019	13117	1.2023	1.33	300	300	2250	1370	
73	124	330	1019	13117	1.2023	1.33	300	300	2250	1370	
74	124	330	1019	13117	1.2023	1.33	300	300	2250	1370	
75	124	330	1019	13117	1.2023	1.33	300	300	2250	1370	
76	124	330	1019	13117	1.2023	1.33	300	300	2250	1370	
77	124	330	1019	13117	1.2023	1.33	300	300	2250	1370	
78	124	330	1019	13117	1.2023	1.33	300	300	2250	1370	
79	124	330	1019	13117	1.2023	1.33	300	300	2250	1370	
80	124	330	1019	13117	1.2023	1.33	300	300	2250	1370	
81	124	330	1019	13117	1.2023	1.33	300	300	2250	1370	
82	124	330	1019	13117	1.2023	1.33	300	300	2250	1370	
83	124	330	1019	13117	1.2023	1.33	300	300	2250	1370	
84	124	330	1019	13117	1.2023	1.33	300	300	2250	1370	
85	124	330	1019	13117	1.2023	1.33	300	300	2250	1370	
86	124	330	1019	13117	1.2023	1.33	300	300	2250	1370	
87	124	330	1019	13117	1.2023	1.33	300	300	2250	1370	
88	124	330	1019	13117	1.2023	1.33	300	300	2250	1370	
89	124	330	1019	13117	1.2023	1.33	300	300	2250	1370	
90	124	330	1019	13117	1.2023	1.33	300	300	2250	1370	
91	124	330	1019	13117	1.2023	1.33	300	300	2250	1370	
92	124	330	1019	13117	1.2023	1.33	300	300	2250	1370	
93	124	330	1019	13117	1.2023	1.33	300	300	2250	1370	
94	124	330	1019	13117	1.2023	1.33	300	300	2250	1370	
95	124	330	1019	13117	1.2023	1.33	300	300	2250	1370	
96	124	330	1019	13117	1.2023	1.33	300	300	2250	1370	
97	124	330	1019	13117	1.2023	1.33	300	300	2250	1370	
98	124	330	1019	13117	1.2023	1.33	300	300	2250	1370	
99	124	330	1019	13117	1.2023	1.33	300	300	2250	1370	
100	124	330	1019	13117	1.2023	1.33	300	300	2250	1370	

Notes on Series B:
Slab No. 27 was loaded to 1211 lbs. (368 lbs. per sq. ft.) when 29 days old the deflection at this time being 7-16%. The above load was then left on the slab for seven days at which time the deflection had increased to nearly 4%. The loading of the slab was then resumed, it breaking under a load of 14770 lbs. (4570 lbs. per sq. ft.).

transmitted to the frame and through it to the foundations, both of which may be designed for a largely reduced dead load.

This method of applying cement produces a complete roof covering, because it is impervious and requires no integral waterproofing compound or composition covering. On ordinary parlin spans, with standard roof loading, slabs 1 1/2 to 1 3/4 in. thick are ample from a structural standpoint. Such a roof weighs 12 lbs. per sq. ft. and, therefore, is not excessive in weight.

ides of the panel. These forms were 8 in. between side faces, and over each side was shot 2 in. of cement and sand. This created a cellular wall consisting of two 2-in. outer walls and an 8-in. air space between them with 6" x 8" columns spaced on about 7 ft. centers. The specifications of the Fire Test Committee of the American Society of Testing Materials provide that a full fire load shall consist of a heat of 900 deg. in 5 min., rising to 1,600 deg. in one hour and finally reaching nearly 2,100 deg. at 4 hrs. and that the face of the wall away from the flames

TABLE III

SERIES C											
Mix 1-3 Span 5 ft. width 4 ft.											
Slab No.	Wt. per ft. of Width	Applied Breaking Load per ft. of width	Total Load per ft. of width	R. M.	Def. Dist.	% Steel	k	l	fs	fc	
7	124	330	1125	13000	1.2023	1.33	300	300	2250	1370	
8	124	330	1035	12600	1.1823	1.33	300	300	2250	1370	
9	124	330	1035	12600	1.1823	1.33	300	300	2250	1370	
10	124	330	984	12200	1.1623	1.33	300	300	2250	1370	
11	124	330	1035	12600	1.1823	1.33	300	300	2250	1370	
12	124	330	1035	12600	1.1823	1.33	300	300	2250	1370	
13	124	330	1035	12600	1.1823	1.33	300	300	2250	1370	
14	124	330	1035	12600	1.1823	1.33	300	300	2250	1370	
15	124	330	1035	12600	1.1823	1.33	300	300	2250	1370	
16	124	330	1035	12600	1.1823	1.33	300	300	2250	1370	
17	124	330	1035	12600	1.1823	1.33	300	300	2250	1370	
18	124	330	1035	12600	1.1823	1.33	300	300	2250	1370	
19	124	330	1035	12600	1.1823	1.33	300	300	2250	1370	
20	124	330	1035	12600	1.1823	1.33	300	300	2250	1370	
21	124	330	1035	12600	1.1823	1.33	300	300	2250	1370	
22	124	330	1035	12600	1.1823	1.33	300	300	2250	1370	
23	124	330	1035	12600	1.1823	1.33	300	300	2250	1370	
24	124	330	1035	12600	1.1823	1.33	300	300	2250	1370	
25	124	330	1035	12600	1.1823	1.33	300	300	2250	1370	
26	124	330	1035	12600	1.1823	1.33	300	300	2250	1370	
27	124	330	1035	12600	1.1823	1.33	300	300	2250	1370	
28	124	330	1035	12600	1.1823	1.33	300	300	2250	1370	
29	124	330	1035	12600	1.1823	1.33	300	300	2250	1370	
30	124	330	1035	12600	1.1823	1.33	300	300	2250	1370	
31	124	330	1035	12600	1.1823	1.33	300	300	2250	1370	
32	124	330	1035	12600	1.1823	1.33	300	300	2250	1370	
33	124	330	1035	12600	1.1823	1.33	300	300	2250	1370	
34	124	330	1035	12600	1.1823	1.33	300	300	2250	1370	
35	124	330	1035	12600	1.1823	1.33	300	300	2250	1370	
36	124	330	1035	12600	1.1823	1.33	300	300	2250	1370	
37	124	330	1035	12600	1.1823	1.33	300	300	2250	1370	
38	124	330	1035	12600	1.1823	1.33	300	300	2250	1370	
39	124	330	1035	12600	1.1823	1.33	300	300	2250	1370	
40	124	330	1035	12600	1.1823	1.33	300	300	2250	1370	
41	124	330	1035	12600	1.1823	1.33	300	300	2250	1370	
42	124	330	1035	12600	1.1823	1.33	300	300	2250	1370	
43	124	330	1035	12600	1.1823	1.33	300	300	2250		

shall not show more than 300 deg. at the highest heat. This panel withstood all these specifications.

The official report states:

"This fire test shows that this type of 'Gunitite' wall construction will furnish a substantial barrier to the passage of average severe flames for a period in excess of four hours. This wall will also furnish sufficient insulation to prevent ignition of ordinary combustible materials stored in contact with one side, when the other side is subjected to the severity of interior fires.

"The impact tests showed that this wall is not likely to be injured to the extent of allowing passage of flames, when it is subjected to the impacts of the fall-



METHODS OF LOADING

Deflections were read at increments of about 500 lbs.

ing timbers of one-story buildings, after the wall has been subjected to severe fire load for more than four hours."

The Canadian Engineer, in an editorial, November 18, 1920, states:

"An interesting by-product of the investigation" (the Slab Tests) "is the additional light thrown on the value of the modulus of elasticity. There appears to be no doubt that the value of the modulus should be taken as at least 3,000,000 for Gunitite, and consequently in the preparation of the tables the ratio of the modulus of elasticity of steel to that of Gunitite was taken as 10. The comparative stiffness of slabs of the material under test afford convincing evidence of the soundness of this assumption."

This type of construction and method of application offer good opportunities for economy in labor, material and time in the building construction field and the tests referred to in this article have supplied data with which it is possible to design such construction with more assurance than heretofore.

Tables I, II and III give the values of k , j , f_s , and f_c , computed by the formulas given on page 277 of Concrete Engineers' Handbook, by Hool & Johnson; first edition, 1918. In accordance with a recent decision of the Joint Committee, the value of 10 for n was used.

The maximum applied breaking load having been reduced to equivalent uniform load, it was then divided by a factor of safety of 4, to which was added the weight of the slab based upon 160 lbs. per cu. ft. as the weight of gunitite. The bending moment (B.M.) was then computed by the Formula $\frac{1}{8} WL$.

In working with the above referred-to load of one-fourth the total breaking load it will be seen that in the very much under reinforced slabs the developed values of f_c and f_s are very much below the definitely established ratings of either gunitite or steel, and in those slabs where there was a high percentage of steel the actual developed values of both the gunitite and the steel were in accord with a rating of about 1500 for a working value of gunitite and about 20,000 for a working value of the steel.

These tables show that failure of the reinforcement occurred in all slabs of 4' span and all of the 6' span slabs except two, while a composite failure of reinforcement and gunitites occurred in the 8' span slabs. The latter would indicate that the critical point in both steel and gunitite had been reached with a reinforcement of .40 sq. in. per foot of width for a 2½" slab on 8' span and .45 and .50 sq. in. per foot of width for a 3" slab on 8' span.

We Are Glad to Correct an Error

WE don't know just how it got by us, but it did, and it was a bad one. In fact, we are in much the same predicament as the engineer who said, when he saw his bridge floating downstream: "By George, I *thought* that decimal point was in the wrong place."

Our attention has been called to the fact that in the second paragraph of page 158, the February 9 issue of THE AMERICAN ARCHITECT stated that "it is good engineering practice to design flues so that there will be 35 sq. ft. in the cross section for every *rated* boiler horsepower."

We wish to say that this should have read: "for every 1000 *rated* boiler horsepower. Meanwhile we hope that no architect has been racking his brain trying to find room enough in the building for a flue based upon the error."

Safety in a Modern Theater*

Provisions Made for Public Safety in the Design of the Capitol Theater, Hartford, Conn.

THE moving picture, either alone or in connection with a vaudeville performance, has long been recognized as one of the leading sources of entertainment in this country. Buildings containing theaters devoted to activities of this kind house millions of people every day, and the havoc that can be wrought when something goes wrong in them is all too well illustrated by any of the several theater catastrophes that have occurred in the past few years.

In most of our cities and large towns, laws and ordinances are provided to regulate the construction of theaters and amusement halls, so as to insure the safety of the patrons of these establishments. Safety for the public should be the first consideration of every theater owner and manager, and owners and managers should not be satisfied with simply complying with the law, but should go far beyond this, and consider every reasonable means of providing comfort and security for their audiences.

There are no doubt many amusement houses that embody the most improved equipment and methods of construction, but as an example of one of the newest of this type we have selected the Capitol Theater recently opened by Mr. S. Z. Poli in Hartford, Connecticut. This theater is constructed and equipped along safety lines, and some of its special features may be of interest.

The theater under consideration is a large one, having a seating capacity of thirty-five hundred; and the seats are about equally distributed between the main floor and a balcony. The building is of fire-

proof construction throughout; the walls are of brick supported by steel frames, and the floors and roof are of steel and concrete. The balcony, which is also made of concrete reinforced steel, is supported by cantilever trusses.

All steps, stairs, and ramps are built with standard gradients, and step lights are provided on the stairs and also along the sides of the ramps, in order to avoid accidents due to darkness.

The stage portion of the theater is separated from the auditorium by a fire wall, and the stage floor is constructed of concrete, ten inches thick, over which

maple flooring is laid. All the dressing rooms are of fireproof construction, and with the exception of the chairs, the furniture used in them is made of steel. Smoking is absolutely prohibited on the stage and in the dressing rooms, but a specially-constructed and presumably safe smoking room is provided for persons using these portions of the building.

In planning the theater, careful attention was paid

to ventilation. In the auditorium, a suspended ceiling provides an air space extending over the entire main portion of the theater. The changes of air in the building are effected by means of a fan about ten feet in diameter, which draws in fresh air from the outside through a large duct in the roof, and forces it through ducts to vents in the walls about the auditorium. In addition to this, exhaust fans situated on either side over the proscenium arch remove the vitiated air. In cold weather, the air supplied to the auditorium is heated by means of steam coils situated in the air chamber, where the incoming air must pass over them before being distributed. Separate ex-



INTERIOR OF THEATER
Showing cross aisle with side exits

*Reprinted from The Travelers Standard, February, 1921.

haust fans provide adequate ventilation in the toilet rooms,—efficiency in this respect being promoted by drawing some of the air out through the toilet fixtures, as well as through registers of the usual form.

The power for the electric illumination system is provided by two separate street mains, either of which has a capacity sufficient to supply current for the entire installation. The lights over the exits are so connected that they will not be affected by trouble on any of the other circuits in the house, and in case both of the power sources should fail at the same time, the lights over all the exits can be supplied with electricity from a battery of dry cells located in the theater building. It is stated that this battery of dry cells is capable of maintaining all the exit lights for a period of six hours.

In case of fire or other emergency in a theater of any kind, it is extremely important to have exits adequate in capacity and well located, so that the audience can leave the building with the least possible confusion and delay. Every floor (including all balconies and galleries) should have an exit capacity such that the combined width of all the available doors and passageways will be at least one foot for every twenty seats on that floor. Furthermore, it is preferable to have the exits from the balconies and galleries lead directly through the exterior walls of the building, and to have every exit from these elevated parts of the building provided with a separate and independent stairway. This may not always be possible, on account of the limitations imposed by surrounding buildings; but in designing a theater these principles should be borne in mind, and they should be applied as fully as the surroundings will permit.

In the case of the theater that we are describing,



EXITS AT THE REAR OF THE AUDITORIUM

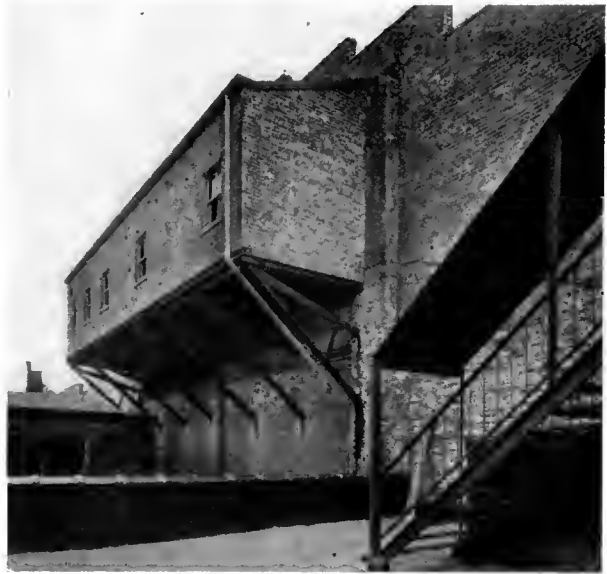

ROOM CONTAINING MOTION PICTURE MACHINES

This room is entirely external to the main building

special attention has been paid to these matters, and numerous well-designed exits provide adequate means for emptying the building in case an emergency should arise. There are forty-five doors, in fact, leading outward from the auditorium, balcony, lobby, and stage. Each of these exits is clearly designated by lights, and all the exit passages are kept lighted during every performance.

On the main floor in the back part of the auditorium, there are five series of exits with three doors in each series. On each side of the main floor five doors open outward (either into an open court or into an alleyway), and in addition to these there are stairways, one on each side, affording a means of exit through a passageway under the stage.

In the balcony, in addition to two stairways to the main floor, three large exits are provided which lead to an open court and thence through enclosed fire escapes to the ground. In the lobby, four exit doors are provided in addition to the doors of the main entrance.

All the exit doors can be opened readily from the inside, because they are provided with depression panels of the latest type, which automatically unlock the doors when a slight pressure is exerted upon them. The outside doors of the building are all equipped on their inner faces with "panic bars," which are operated by merely pushing against them.

An ample number of fire extinguishers is provided in the auditorium, as well as on the stage and in the rooms under the stage. In addition to this means of protection against fire, stand-pipes and fire hose are provided on the stage and in the hall under the stage.

There is an automatic sprinkler system in the rear of the proscenium wall, both above and below the stage, and also in the boiler-room, dressing rooms, and picture booth. The fire curtain on the stage is equipped with a lock-catch type emergency device. The skylight over the stage is composed of glass panels held in place by light ropes provided with fusible link connections. If a fire should break out, these links would melt quickly and the glass panels would then slide down upon the roof of the building, leaving the skylight entirely open. This would allow the flames, smoke, and heat to pass out through the roof, and would tend to prevent the fire from spreading to other parts of the building.

The sprinkler system is connected to the city water mains, and it is also provided with connections, outside the building, for attaching hose from the city fire apparatus. In addition, an elevated water tank of large capacity is provided, to furnish an adequate supply of stored water in case of temporary failure of the city supply. In cold weather this tank is heated, internally, so that there will be no danger of the water supply failing on account of freezing.

The moving-picture booth is probably the most unique feature of all in this theater. It is situated back of the balcony, and is entirely outside of the main building wall, being supported by heavy steel brackets and trusses. It communicates with the auditorium only by means of openings in the main wall,—openings consisting in the necessary doorways to admit the operator, and in small apertures through which the pictures are projected. Steel doors, and shutters held open by fusible links, are provided for these openings, and the roof of the booth is equipped with ample ventilating pipes. In case of fire, the booth is automatically and effectively isolated from the rest of the theater. The chairs, tables, and other furniture used in the booth are made of steel, and the generators and other electrical apparatus used in connection with the motion-picture projectors are situated in a separate room, by themselves.

For the convenience of women patrons, the management has provided a rest room, equipped with a first-aid cabinet containing the usual surgical supplies and also spirits of ammonia, smelling salts, and other emergency remedies. The room is in charge of a matron who is proficient in emergency-treatment methods.

The management of the theater conducts an ushers' school, which meets frequently to discuss problems arising in connection with serving the patrons. Each usher is taught what he or she is to do in case of fire or other emergency. Suggestions for improving the service are solicited, and the recommendations that are made by the ushers receive careful consideration from the management.

The Estrangement Between Engineers and Architects

That an unfortunate estrangement exists between engineers and architects that is detrimental to the accomplishments of both professions is apparent to one who observes the relations existing between the professions. Writing in the *Engineering World*, the editor states that engineers are inclined to criticize architects for not being practical, whereas architects are inclined to criticize engineers for not being artistic. Engineers prefer to execute their work without the advice of architects; architects, likewise, prefer to execute their commissions by themselves. Both groups, whether motivated by jealousy of personal attainment or by a sense of paternalism for the respective professions fail to recognize the fact that they have many interests common to each other, that very few development problems are exclusively engineering or exclusively architectural.

The reason for the estrangement is not difficult to uncover. It lies squarely in the training which the embryonic architects and engineers receive. In schools in which both engineering and architectural courses are provided, students are encouraged by their associations from the day on which they enter the professional schools, if not to be exclusive in their relations, at least not to be democratic in them. In schools in which only the one kind or the other of the courses is provided, the encouragement exists because of the absence of the one course or the other. The fact that the encouragement is or may be unintentional on the part of those who arrange the courses of study does not alter the consequences.

Amicable relations alone, however, between engineers and architects are incapable of relieving the state of industrial confusion and inelegance that exists. This state of affairs can be relieved only when the architect knows more of the fundamental principles of engineering—more analytical mechanics—and when the engineer knows more of the fundamental principles of design; when the architect thinks in terms of quantity as well as in terms of quality, and the engineer thinks conversely. The most enduring and most beautiful structures of all history were built when the school of architecture and of engineering was one institution. The least enduring and least beautiful structures of all time have been built since the schools of architecture and of engineering have been separated. The duty of the technical schools is obvious. Let them teach engineers more architecture and architects more engineering and a more economical, more substantial, more healthful and more beautiful industrial age will occur. Moreover the estrangement existing between engineers and architects will vanish.

Saving by Zoning

Throughout the country, the interest in zoning—chiefly as a stabilizer of land values—is growing at a rapid rate. George B. Ford, in a recent communication speaks of more than a hundred communities that are on the point of starting proceedings for zoning ordinances. He mentions two instances as illustrating the economy of zoning:

“In New York city the increased taxes based on the benefits arising from the zoning law have already paid the cost of drafting the ordinance and maps several times over. Millions are being saved in transit extension because now at last the engineers know exactly the kind and amount of development possible in each section of the city.

“St. Louis claims it would have saved two and a half million dollars in the extension of its sewer system had the zoning been in force earlier. Water system extension, paving programs, even fire protection and school programs in New York, St. Louis and Newark are showing marked savings, thanks to a definite plan of growth for the city.”

Mr. Ford and his partner, E. P. Goodrich, have come to the conclusion that zoning can, to great advantage, be simplified from the ten to nineteen different kinds of districts usually adopted to perhaps six types of coterminous districts. In their plan for East Orange, N. J., they found it possible to make certain zoning districts coterminous with fire limits under the building code and to cover everything that has to do with building, formerly contained in seven or eight different ordinances, in two, the building code and the zoning ordinance.

Ethics for the Contractor

To the engineer who, in the construction industry, has arrogated to himself the only professional status, it will come as a shock or as a cause for incredulous smiles to hear of the contractors discussing a code of ethics, says *Engineering News-Record*. Yet they are discussing one; they are doing it seriously and honestly, and not as a camouflage measure. They go so far as to put contracting into a professional class. They conceive of themselves as service organizations accepting obligations toward a client.

This attitude, too, has a solid foundation. They are not manufacturers merely putting before a prospective purchaser a finished product which he can examine and test, and determine, with the article in hand, whether it is worth the demanded price. No, they are manufacturers employed, or as their own language would have it, “retained,” to produce in the future a certain structure. Documents attempt to tell what that structure is to be; many precautions are taken to assure delivery of an article con-

forming to the documentary descriptions, but despite documents and drawings and contract articles what the purchaser ultimately gets depends in large measure upon factors not definable, upon the “skill, integrity, and responsibility” of the contractor. Is it far fetched, then, to consider that the contractor has accepted a responsibility akin to the professional? We think not.

General appreciation by contractors of the character of that responsibility and serious acceptance generally of a professional code are not soon to be expected. There will be many lapses. There must be much educational work. But the attitude of engineers toward the contractors’ new endeavors must be that of encouragement. It will be easy to poke fun and to cite the rascal who was caught skimping cement in the last sewer job. Such an attitude never helped anyone to higher levels.

The contractors, it is true, must prove the sincerity of their endeavors, but the number of sterling contractors who are putting their shoulders to the wheel to realize these aims warrants the faith and confidence, and the assistance, of the engineering profession.

How We Look from Above

Photographs taken from the air by aerial travelers show the ugly spots on the beautiful landscape made by man’s artificialities. Houses resemble confetti scattered on a green rug; fields look like a crazy-patch quilt. Roads and paths are puzzles for Sherlock Holmes to solve.

Contrasted with these views, however, are many truly beautiful estates whose design ornaments the general landscape in a pleasing fashion.

The new angle of view affords opportunities for the future landscape architect. Cities of the future can be planned from the air; indeed, this method is already being used in planning the suburbs of some of our large cities.

The Origin of the Corinthian Capital

It chanced one day in the fifth century B. C., that Callimachus, a famous Corinthian architect, passed by a maiden’s tomb and noticed thereon a tile over which an acanthus plant had spread its foliage.

Pleased with the beauty of the leafy contour, he copied it, and upon erecting columns at Corinth shortly after, capped them with his newly discovered design. Thus, according to tradition, was the Corinthian capital conceived.

Adorning classic friezes, vases and bronzes, traced upon the works of gold and silver smithcraft, the acanthus leaf has lived through the succeeding ages—it is “the leaf that never died.”

Plan to Pipe Coal

It is suggested by Reginald P. Bolton, consulting engineer, to move coal from Scranton, Pa., to New York City through two 14-inch underground pipes by water pressure. The distance is 130 miles. Scranton is 2,000 feet higher than New York, thus giving a natural pressure which it is thought will carry the mixture of coal and water at the rate of seven feet a second. He estimates that the two pipes would carry seven million tons of coal a year.

Good-Bye to Little Red Schoolhouse

West Virginia Substitutes Good Roads and Motor Buses

Though less apparent than the fattening effect on the farmers' purses, the service of the "good-roads" program to the farmers' children of several counties in West Virginia is no less real. Prior to the building of the splendid concrete highways which these localities now boast, the boys and girls commonly made their way on foot or horseback to dozens of little one-room district schools. Now they are whisked in automobiles to a few centralized, consolidated institutions, administered like the best city schools. The busses operate on schedule, and on every day of the school year, rain or shine.

Stage Settings from Blocks

A novel but very effective stage setting first used in the production of French plays in New York city, based entirely on a system of angles, is described in *Popular Science*. When the stage director for the French Players in New York is ready to plan a scene, he goes to his drawing-board and draws a diagram of the stage. Then he takes pieces of dark-colored paper, cut in the form of squares, and fits them on the diagram until he obtains the effect he seeks. The little squares of paper are all cut according to scale, each square representing so many feet on the stage. After the stage setting is all worked out on the drawing-board, the director is ready to set the stage for rehearsal.

Once the preliminary work was done in the studio, it was only a matter of a few minutes to set the stage. Back of the stage are piled numbers of square blocks and several other blocks in the shape of steps. Two of these steplike blocks, fitted together, make one large block about four times the size of the plain square blocks. Beside these curious-looking blocks stand lattices, doors, and windows. At the back and at the sides of the stage are permanent wooden pillars. The lattices, doors, and windows were so made that they fitted between these pillars. They are all made in such a way that they are interchangeable. It is not necessary to have two

sets of scenery, yet, when the stage is set, the scenes presented have an entirely different appearance.

This type of scenery lends itself to the production of both outdoor and indoor scenes. Almost any arrangement of a simple or formal garden can be accomplished with the blocks and lattices, while out of the combination of the interchangeable doors, windows, and blocks can arise a room suitable for a peasant's hut or a king's palace.

Memorial Competition

The Barre Quarriers Assn., of Barre, Vt., representing the donors of a \$10,000 prize fund have inaugurated a competition for the purpose of obtaining a suitable design for a Soldiers and Sailors Monument to be erected upon the public park at Barre, Vt., at a cost of \$60,000.

The donors have prepared a program governing the competition which has the approval of the committee on competition of the Boston Society of Architects, A. I. A. and have appointed as Advisor, Mr. W. A. Murray, 59 Washington St., Barre, Vt., to whom all communications shall be addressed, and from whom a copy of the program may be obtained.

To initiate the program the Advisor desires to extend a public invitation to all sculptors and architects to submit evidence of their professional experience, educational and other qualifications.

Pueblo Architecture in Concrete Woodwork Practically Eliminated in Quaint Pueblo Styles

All the quaint charms of the old pueblo style of architecture is preserved in concrete in a series of little cottages now under construction in Monrovia, Cal., says *Popular Mechanics*. The one-story buildings are most remarkable for their complete use of cement, woodwork being practically eliminated. Even the roofs are concrete, and the doors are made of magnesite. The poured walls, 5 in. thick, inclose a web of waterproofing material, while the cement floors are stained in Spanish leather effect, waxed and polished. The little structures are wholly fireproof, and easy cleaning is assured by the absence of mouldings, casings and baseboards. Inclosed courts off the kitchen and sleeping chambers, partly roofed and partly screened, provide outdoor protection and privacy.

Finns Develop Own Architecture Architecture Develops with Increase of Material Wealth

For years Finland possessed no architecture of its own. Finnish architectural students not only sought their training abroad, but were forced to remain

abroad for a livelihood. Stone was a luxury which few could afford. Only the public buildings were of stone. The wood-built towns were so frequently swept by fire that all desire for architectural beauty was destroyed. German and Italian architecture prevailed, and though great art upheavals swept other countries, Finland remained untouched.

Then came an increase of material wealth and with the increase Finland began to develop a few building ideas of its own. Today there are structures of granite and stone, and though German influence is still strong, the Finns have adopted a plainness and simplicity of style characteristic of themselves. Finnish architecture has a wealth of proportion and massiveness, with a lavishness of original ornament. Though simplicity usually prevails, sometimes a freakish shape is given to towers, spires and corners.

On all sides, from the buildings housing the headquarters of the American Red Cross and those in which more than 10,000 Russian refugees have been cared for to the buildings in the pretty Helsingfors Boulevardsgatan, may be seen the beginning of Finnish architecture. Granite and stone, together with bricks covered with plaster, produce beautiful and fantastic ornamentation.

The Versatile Coconut Palm

In the islands of the Southern Seas, the coconut palm supplies all of the needs of the members of society. It supplies the natives with lumber to build their homes, their boats, and their utensils.

When the leaves of the tree are young, they are eaten. When they are old, they are woven into hats, clothes, baskets, bedding, paper, and thatch. The ribs of the older leaves are made into spears, arrows, brooms, torches, and paddles.

The flowers of the tree give the natives wine, vinegar, and sugar. The fruit of the palm yields oil, foods, cord, and matting.

It is said that even the roots are sometimes used as food.

To Beautify Basements

Throughout the country there seems to be a general movement tending to beautify the cellar. This campaign, it is declared by those most interested, was not born of prohibition, but by a feeling that the basement may be made as cheerful and inviting as any of the rooms overhead.

Concerns dealing in heating apparatus are featuring the plan in all or at least most of their advertising matter. The cellar, so long the storage place for ashes and all kinds of debris, is now pictured as a neat, almost luxurious room. It is portrayed with

all the spotless appearance and general comfort of a living room.

To bring about such a condition many suggestions have been advanced by the advertisers. In the first place it is set down that the heating apparatus must shake off its drab dress and assume one of brightness. The boiler casing should be polished and symmetrical, and the nickel trimmings kept free from dust. Other suggestions are tile floors, enameled walls and coal bins constructed of stained wood.

Some of the larger heating concerns are bending every effort to make the movement widespread. Already it has met with considerable favor, and gives every indication of growing in popularity.

Landmarks for the Aviator

Standard arrangement of landing-fields would be an advantage to the itinerant airman who flies at night and who comes down in a strange region, declares *Popular Science*. For instance, if the pilot knows where the radio tower is placed with relation to the airdrome, he would know at once how to avoid a possible crash in approaching the field in thick weather. Vertical and portable searchlights illuminating the field are indispensable.

Directing an airplane by wireless, the so-called "radio localizers" on the modern landing-field should bear a definite relation to the position of the airdrome. A plan suggested by the United States Air Service furnishes an ideal arrangement of these details. On one side of the airdrome is placed the meteorological and radio equipment structures, which project upward and obstruct a clear approach to the field. On the other side of the airdrome are the localizers and the fog-dissipation mechanism built underground, and the markers. Here nothing projects into the air to hinder low flying when looking for the landing-place.

Bungalow on Factory Roof

A piano factory in Cincinnati has the distinction of possessing a bungalow on the roof of its new factory. A complete bungalow of English design and a beautiful garden, with hedges, walks, flowers and trees has been provided. The entire construction is an architectural novelty for it will not rest on the roof of the factory. Reinforced concrete columns will be brought through the factory roof. The foundation for the garden and bungalow will be built on I-beam supports resting on these columns. The bungalow is to be used as a meeting place for officers and directors of the company; but the plans show a structure of exceptionally homelike possibilities. There is an immense living room, with a big open fireplace. There is a kitchen, an enclosed dining

THE AMERICAN ARCHITECT

porch, bathrooms with tub and shower baths, and a big stone terrace leading to the garden. There is to be a lawn with a number of walks, several of them beach pebble paths, and one a plank walk "country style." A red tile roof, of sweeping slope, will converge with the tile edge of the factory roof at the south end of the building. The bungalow will face toward the north.

Book Notes

"A BOOK OF CEILINGS." By George Richardson. London: 1776. Reprinted and published by Wm. Helburn, Inc., New York. \$12.50.

An excellent book dealing with plaster ceiling design is George Richardson's "A Book of Ceilings," reprinted by William Helburn, New York. This work was originally published in London in 1776, and the present reprint is a faithful reproduction. Previous to its publication Richardson was associated with the brothers Adam and it is claimed that many of the so-called Adam ceilings were actually conceived by Richardson. The book consists of forty-eight plates, showing line drawings of the ceiling designs and forms a very complete exposition of the Adam style.

The 1921, 29th edition of Hendrick's Commercial Register, is published. Several new features have been added in the way of indexing. The book is published by S. E. Hendricks' Company, Inc., N. Y., and furnishes a directory of manufacturers in different industries.

Personals

A. D. Taylor, landscape architect and town planner, has moved to 405 Cook Building, 4614 Prospect avenue, Cleveland, Ohio.

John J. Wilkens, architect formerly of Kyle & Wilkens, architects of Charleston, W. Va., is now located at 402 Durner Building, Peebles Corner, Cincinnati, O., and desires manufacturers' catalogues and samples.

Mr. M. Hamdy, Bey El Kattan, State Buildings Department, West Division, Alexandria, Egypt, is desirous of receiving catalogs and other literature regarding American products suitable for use in con-

structing schools, hospitals, prisons, tribunals, post and telegraph offices, railway stations and bridges, houses and buildings of all kinds.

John P. Kingston & Son, architects, suffered large damages in the recent Worcester fire and have now reopened offices at 220 Park Bldg. Full supplies of manufacturers' samples and catalogues are desired.

P. S. Clark has opened an office at 703 Krise Bldg., Lynchburg, Va. Catalogues and samples are desired.

Kanzor Bros., architects, Dollar Savings & Trust Bldg., N. S., Pittsburg, Pa., announce that this is their correct address and not Renshaw Bldg. where mail is frequently addressed to them.

Wilbur Herby, architect, has opened an office at 202 Bonner street, Dayton, O. Mr. Herby was formerly practicing with his brother under the name of Chas. Herby Sons, in the U. B. Bldg., Dayton.

Murphy, McGill and Hamlin, architects, formerly Dana & Murphy, are now located at 331 Madison avenue, New York City. Richard H. Dana, formerly connected with the firm, is now practicing alone.

Percy D. Bentley, formerly of the firm of Merman & Bently, LaCrosse, Wis., has opened an office for the practice of architecture at 505 Exchange Bank Bldg., St. Paul, Minn., and desires catalogs and samples.

Frederick A. Strauel, architect, has opened an office for the practice of his profession at 125 Northwestern National Life Insurance Bldg., Minneapolis, Minn. The Minneapolis office of Purcell & Almslie, architects, is in charge of Mr. Strauel and he will continue to look after their interests in that section. Other offices are located in Chicago and Portland, Ore.

C. E. Shepard, architect, announces the removal of his offices to 509-11 Reliance Bldg., Kansas City, Mo.

Clinton Paine Greer, architect, has recently opened an office at 2209 Roslyn avenue, Baltimore, Md., and desires catalogs and samples.

Weekly Review of the Construction Field

With Reports of Special Correspondents in Regional Centers

What About Industrial Building?

A Few Facts on Industrial Building Prospects for 1921, Based Upon a Recent Survey Made by
THE AMERICAN ARCHITECT

THE AMERICAN ARCHITECT has recently made a careful survey of the building programs of several important industries. The indications given below were gathered from authoritative sources, and show briefly what may be expected in these various businesses and industries.

There is every evidence of a large increase in bank building. The banks are all prosperous, most of them are outgrowing their present quarters, and they have found out that the building of new structures always leads to an increase in business. The Gotham National Bank Building in New York is one among several important new banking structures which are now being erected throughout the country.

A great world market for American textiles, and the very possible reduction in the cost of living and therefore of wages, will carry forward the contemplated extension of mills in New England. There will be development of new mills in the south, close to the raw goods market. The silk field will not provide very much building, as this will consist, for the most part, of "small stuff," but there is likelihood of considerable "small stuff."

There will be considerable extension of paper mills, and these will be of the very highest type of construction. The greatest extension will be in Canada, but there will also be building in the south, where advantages will be made of the so-called "jack pine," and where there is also the likelihood of a development of paper making from cotton hulls and linters.

The first endeavor of the railroads will be to improve their rolling stock and rights of way. Bridges will be their first structural undertaking. In this field there is need of extension to round houses, freight shops, car shops and railway terminals. Some of this work will be undertaken in 1921.

There will probably be no great extension in steel mills, foundries or buildings of machine tool manufacturers during the coming year. The endeavor in this field will be to increase production by means of increased individual human efficiency and increased output on mechanical operations.

Orders are now placed in the electrical industry for an 8 per cent. increase in generating capacity over the existing capacity, and this increase in generating capacity will require about 10 per cent. increase in floor space. About half of this increase of floor

space will come from extension of existing plants. In Hydro Electric development, little is looked for in the immediate future, but a 90,000 horsepower development is now going forward in the south, and the Ford development at Troy, New York, is going ahead.

They Have Always Gone Up

Wages in the Building Trades for the Past 700 Years Show Steady, Determined Upward Trend—
William Hardy's Research Shows Increase from Year 1250

The only way to judge the future is by the past, said Patrick Henry, and on that basis there is to be a continuation of wages at present or higher levels.

For the last 700 years, ancient records of the history of the building trades in London show a constant upward trend. With the exception of the downward curve for a short period in the Thirteenth Century, the scale has invariably been a rising one. William Hardy, who conducted the research, sums up his conclusion as follows:

"Once again history has repeated itself, and the lesson taught by these investigations is undoubtedly that wages when they have once risen never fall. Is it not time, therefore, that we adjust our accounts to the new standard? It is false optimism to believe that the near future will show us a return of old conditions. History shows that only by stabilizing the controlling factor—wages—is it possible to fix the price of commodities. When an increase has been sanctioned it must be realized that such increase has brought us to another rung in the ladder of wages of which the lower rungs have been forever destroyed."

He thus gives the pay to laborers, the penny being calculated at two cents:

Wages		Wages	
Year	Per Day	Year	Per Day
1250.....	.03½	1650.....	.28
1300.....	.05	1700.....	.40
1350.....	.06	1750.....	.40
1400.....	.06	1800.....	.58
1450.....	.08	1850.....	.72
1500.....	.08	1914.....	\$1.60
1550.....	.10	1920.....	5.00
1600.....	.16		

These statistics reflect conditions in England. But the general trend in America has not been dissimilar, and the same deductions may be applied to the labor situation here.

THE AMERICAN ARCHITECT

(Special Correspondence to THE AMERICAN ARCHITECT)

CHICAGO.—There is much ground for optimism in the building report just issued by Building Commissioner Bostrom for the month of February. It shows that 311 permits were issued as compared with only 166 issued in January of this year and 276 issued in February, 1920. The February permits are classified as follows: apartments, 41; residences, 181; factories, 75, and miscellaneous buildings, 14. There is a particularly big jump in the matter of apartments, last month having shown 41 permits as compared with only 13 issued in January and 12 in February of 1920. As far as valuation is concerned, February permits have the ascendancy, also. The value of the proposed buildings is estimated at \$15,366,000 as compared with an estimated valuation of only \$4,119,000 for the month of January.

Experts are inclined to feel that the improved situation as indicated by the growing number of permits is the beginning of an important resumption of activity in building in Chicago, although there is still a great deal of discussion and hesitation regarding building projects.

Some very important construction is being held in abeyance until a settling of labor and material costs permits the "go ahead" signal to be given with a greater feeling of rock-bottom security. In this list should be included the Fair department's store building for men, the new bank and office building of the State Bank of Chicago, the new building for the Illinois Trust group of banks. Permits have been issued for these buildings and plans are drawn up. The only thing that is delaying the early beginning of construction is the feeling on the part of bank directors and building authorities engaged in the construction that things have not yet reached the rock bottom and the building is likely to be held up until the readjustment period has been completed.

Progress has been made in the preparations for the Illinois-Merchants Trust Company building which is to be located on LaSalle street, immediately opposite the Federal Reserve Bank building, which is already in process of construction. The bank has even gone so far as to purchase some of its marble, steel and other materials. Steel is already being received and stored, while the marble is enroute from Italian quarries and should be here within a few months at the outside. The marble was obtained at a very low rate, it is announced, because the bank was able to take advantage of the exchange situation.

This building will be almost a counterpart of the Federal Reserve Bank which it will face across LaSalle street. It will be twenty-one stories high and will take full advantage of the city's building limit of 260 feet above the sidewalk level.

The Federal Reserve Bank contract has been awarded to John Griffith & Sons, the contract price being \$7,500,000. The Illinois-Merchants Bank will cost in the neighborhood of the same amount.

Chief activity continues to center, however, in small residential buildings in suburban properties. The number of permits is indicative of this, although much of the suburban activity would not register in the city's building permit reports.

An important conference of the week has been a session of the National Federation of Construction Industries. This body gathered at the Hotel Sherman in response to a call from the Philadelphia Chamber of Commerce. The meeting has taken the trend outlined at a recent conference of building industry leaders which convened in Chicago at the suggestion of the National Lumber Manufacturers Association. Ernest T. Trigg, chairman of the industrial relations committee of the Philadelphia Chamber of Commerce, who presided at the conference, sounded the keynote of the meeting when he emphasized the importance of getting all phases of the building industry down to rock bottom, as far as price is concerned, in order to win and hold public confidence.

"The public is on strike," said Mr. Trigg, "and we must put prices down to where they will warrant investors getting back into the field. Labor costs must be adjusted, not entirely by a quick reduction of wages but by greater efficiency.

"Material prices are not down to the average of other commodities. To get the confidence of the people and investors we must get down to normal."

Other speakers echoed the sentiments of Mr. Trigg, among them Daniel Crawford, Jr., a prominent builder of Philadelphia, who criticised banking interests for their lack of liberality in considering building loans—which the conference regards as one of the important obstacles in the path of building all over the country.

"The best risk that a banker can take," said Mr. Crawford, "is to lend money to the man who wants to buy or build a home for himself. If the man's stability of character is first investigated, no better loan can be made. Banks are not nearly liberal enough, and if they do not become disposed to loan more willingly they might as well quit loaning altogether, because their unwillingness is prohibitive to most prospective home owners."

Mr. Crawford indicated that 80 per cent. of the value of property is not too high a proportion for a loan.

The banker's point of view was expressed by Harry A. Wheeler, vice-president of the Union Trust Company of Chicago. He explained that the present re-discount rates are the real obstacles in the way of cheaper money for building.

THE "AMERICAN ARCHITECT"

"If re-discount rates were lowered today," said Mr. Wheeler, "current money rates would fall within forty-eight hours. From our viewpoint, that is the biggest item now obstructing financing of building projects. If the Federal Reserve system will lower its rediscount rate in conformity with the rate now prevalent in a number of commodities the banks will immediately lower their interest rates on money."

As the time for the "Own Your Home" Exposition draws nearer, the feeling is more general that this show will provide a very powerful stimulus for home building. All phases of the building industry are to be represented at the Exposition which is to be held at the Chicago Coliseum March 26-April 2. Henry K. Holsman is chairman of the architectural division, and an exhibit of more than ordinary interest is now being prepared.

Another exhibit in which architects are interested is to be held at the Art Institute from March 8 to April 5. The exhibit will be a combined display of architecture, landscape design and applied arts, and will, in the hope of the architects, bring about a closer co-ordination of all the arts related to building. Among the participating organizations are the Illinois Chapter of the American Institute of Architects, the Illinois Society of Architects and the Chicago Architectural Club. John A. Holabird, a well-known Chicago architect, is chairman of the exhibition committee.

In the building materials field the past week has shown very slight changes in prices. Practically all lumber items remain the same, with no demand to speak for any of the grades or varieties of lumber. In the building supplies list there have been some minor revisions affecting cement and lime.

The general prices are about as follows:

Yellow Pine: B. & B. 1-in., \$95 to \$130, depending on thickness; 2 x 4, No. 1, 10 to 16 ft. length, \$51 to \$53; 2 x 6, \$48; 2 x 8, \$50; 2 x 10, \$53; 2 x 12, \$55; 13-16 x 3 1/4 z & b flat flooring, \$85 to \$90; 1 x 6, No. 2 common, \$48 to \$90. *Douglas Fir:* 2 4 S, in sizes up to 12 x 12, in length up to 32 ft., \$65 to \$70; 14 x 14, \$68 to \$73; 16 x 16, \$72 to \$75; 18 x 18, \$75 to \$80. *Hard Maple:* Four, 1/4 No. 1 and 2, \$135; select, \$120; No. 1 common, \$100; No. 2 common, \$65; No. 3 common, \$32. *Birch:* Four 1/4 No. 1 and 2, \$160; select, \$133 to \$138; No. 1 common, \$95 to \$100; No. 2 common, \$60 to \$65; No. 3 common, \$40. *Red Gum:* Four 1/4 No. 1 and 2, \$150; No. 1 common, \$90 to \$92; No. 2 common, \$45.

Face Brick—Standard, vitrified red, \$32.00@34.00; Smooth, Indiana red, \$38.00@40; Smooth, Ohio red, \$38.00@40.00; Smooth, Pennsylvania red, \$46.00@48.00; Smooth, buff, \$45.00@47.00; Smooth, gray, \$47.00@49.00; Rough, buff, \$44.00

@46.00; Rough, gray, \$47.00@49.00; Variegated, rough texture, \$34.00@49.00.

Common brick, \$13.00 to \$16.00 per M. Portland cement, \$2.25 per bbl. Torpedo—Lake and bank sand, \$3.50 per yd. Crushed stone, gravel screenings, \$3.50 per yd. Hydrated lime, Ohio, paper, \$21.00 per ton. Hydrated lime, Ohio, cloth, \$29.00 per ton. (Includes sacks at 30c each.) Hydrated lime, Wis. paper, \$19.00 per ton. Bulk lime, \$1.65 per ton.

(Special Correspondence to THE AMERICAN ARCHITECT)

SEATTLE—Due to competitive conditions on the Pacific coast which have no present connection with the mill basis, sheet metals and bars used in building construction have been lower, with Portland houses taking the initiative in the decline just at the time when building investors were ready to start figuring for their season's work.

Seattle jobbers deplored the cut inasmuch as it effectually stopped all building projects that had to do in any degree with sheet metal. The task of educating builders to feel that steel prices had reached bottom has been carried on with much success by jobbers, architects and contractors to the end that vitally needed construction be gotten under way and the materials put on the job. About all the constructive results that have been taken from the unsettlement was to hold up pending work. It seems certain that it has not moved any more materials, as local jobbers report a reactionary tendency.

Stocks of cement, plaster, roofing and brick are now plentiful at all large coast jobbing centers. Jobbers are unable to understand why brick, which is manufactured here in quantity and in all grades, is holding firm. The market shows no signs of weakening.

Competition among roofing jobbers is keen, and all are eagerly out for business. Bids were opened by the Alaska Engineering Commission this week for an order approximating \$200 for the government railway in Alaska. Seventeen bids were submitted, and while there were a few duplications from San Francisco, Portland and Seattle bidders, seventeen houses were represented. Bids ran from \$1.59 per square to \$4.90 per double roll. In no event was it possible to take a greater profit than \$20 gross on the contract, and several of the bidders offered bids on a basis of \$12 gross. The order was only 20 per cent. of that given last season. The zeal and number of bidders for so small a contract convinced local jobbers that the patent roofing houses are in a fair way to over-supply their product, and are being closely followed up with competition from red cedar shingles.

Robert D. Kohn, architect of New York, on the

coast on a business trip, is advocating the co-operative apartment house plan. He favors it because of its convenience for those who travel considerably as a home that can be left at will without the assistance of caretakers.

Harlan Bartholomew, of St. Louis, was called to Seattle by real estate and building interests in behalf of the proposed zoning system.

Despite the heavy overstocks of fir lumber at the mills such assortments as finish, vertical grain flooring and ceiling are running short. Prices have remained stationary excepting in short dimension. Enquiries from eastern buyers vary from day to day and in different selling agencies. Some mills and wholesalers report an increase, while others give it as the sense of eastern buyers that book accounts are not liquidating as speedily as hoped. Fifty members of the Retail Lumbermen's Association of New York who have been in the West Coast fir territory for a week express themselves as satisfied that fir lumber will be in brisk demand next Spring despite the high transcontinental freight rates, and orders were placed by these retailers for several hundred thousand feet.

About 55 per cent. of the fir mills are in operation. Wholesalers are covering up and closing as fast as possible. It is desired to have a clean slate before the middle of March. While these operators are not willing to predict more than a stiffening of the Spring market, there is an undertone of strength.

Conferences at Chicago between West Coast lumber manufacturers and officials of the transcontinental line railways in March relative to lower freight rates are expected to bring definite reductions. The transcontinental lines are getting no eastbound tonnage, and are desirous of getting the business. Low water rates already established have caused some anxiety to the overland carriers. This rate from

Puget Sound to New York is \$20 per 1,000 feet, or \$11 and more under the all-rail rate.

The New York lumbermen booked their orders to go by water.

Unemployment Cannot Stop Saving Savings Banks Accounts in Third Federal Reserve District (Philadelphia) Increase—80,000 Out of Work in Philadelphia—Resumption of Building Would Relieve This Condition

The current business review of the Third Federal Reserve District states that unemployment figures, as reported by the Pennsylvania State Department of Labor, show 80,000 out of work in Philadelphia and about 65,000 in other leading cities of this district. Negotiations for resumption of building will, if successful, greatly reduce these figures, the bank reports.

Savings bank accounts in all parts of the district increased in January. Debits to individual accounts as reported by member banks of thirteen Clearing Houses show declines of \$45,000,000 for the month and almost the same for the year.

In a chart of the general business situation, the Federal Reserve Bank of Philadelphia shows the situation in brick, iron and steel, lumber and plumbing supplies to be as follows:

Business	Demand	Prices	Raw Material Situation
Brick	Limited	Downward	Improved
Iron and steel	Very poor	Downward	Plentiful
Lumber	Limited	Downward	Ample
Plumbing supplies	Limited	Downward	Improved

The whole table shows conclusively that the general business situation has decidedly improved for the industries of Philadelphia and other cities of the Third Federal Reserve District.

30^r a

Continued to No. 2360



MONUMENTS OF DOGES SILVESTRO AND VALIER, AND DOGARESSA VALIER,
IN CHURCH OF SANTI GIOVANNI E PAOLO, VENICE

THE AMERICAN ARCHITECT

VOL. CXIX

WEDNESDAY, MARCH 16, 1921

NUMBER 2360

An Echo from "Westward-Ho"

An Interesting Comment by a Subscriber on the Article "Westward-Ho" in the Issue of February 9

IT is at once inspiring from a sense of opportunity and disconcerting from a sense of incapacity that those vitally concerned with the teaching of architecture in the mid-western universities may well read the admirable contribution called "Westward-Ho" in a recent number of THE AMERICAN ARCHITECT. The inspiration comes from the recognition and appreciation, so well expressed, of the responsibility which the University School of Architecture has to shoulder if architecture is to become, as it ought, the symbolization of the American civilization of the next fifty years, that civilization being, as quoted, the civilization created by the Middle West. The disconcertation is in the realization that in the strict sorting of the "quick" from the "dead" in the architectural products that the college trained designer has yet produced, the "dead" quite overbalance the part that can claim any of the merits of the "quick."

Is it that the Middle Western School, relying upon the second-hand inspiration of lantern slides, photographs and prints—impossible as it has been for but a few students to become actually familiar with great works of architecture—fails to generate within the minds of its graduates that virility that makes for the "quick," the living in architecture? Are the level prairies, the grey landscapes, the predominance of Main streets and the consequent contagion of the provincial small town virus productive of too dark and oppressive a cloud to permit the academic light to penetrate? Are all the stupid revivals, all the employment of ill-conceived architectural forms—classic orders that do not function, senseless decoration that does not adorn—all the adaptation of materials to forms foreign to their very nature in order that some historic style may be claimed—are all these illegitimate offsprings of a so-called architectural education to be laid on the doorsteps of the Schools of Architecture?

Such questions may well be asked by anyone who,

seriously concerned, surveys the trend of architectural creation during the past generation. Truly, the treatment of "imposing structures" by rendering "correctly proportioned basement, colonnade and entablature duplicate of those erected by the ancients for an entirely different purpose and relationship to the building itself"—this was the easy and obvious thing to do in a new nation that is a composite transportation of older eras of culture. That such structures now strike us as "dead" is a sign of growth in the appreciation of the true spirit of architecture. Yet, without having gone through the periods of ardor for the Classic, of worship of the Gothic, of admiration for the Renaissance, it is not probable that there could ever develop what eventually may be the "quick" American architecture.

Corinthian water-gates and peristyles, French domes and Spanish turrets, casting reflections of sepulchral whiteness upon the cold blue of Lake Michigan may indeed have mirrored upon an ill-burnished shield the glory of foreign and departed peoples. But were they less true to type of heritage than the people who walked beneath their shadows? The descendants of brawny Anglo-Saxon and Teuton, ancestors who had once been strongly influenced and tempered if not subjected by Roman conquest; blonde Swedes and fiery Celts, mingling with brunettes of Italian and Greek origin; Slav and Turk, Pole and Franc, African and Asiatic—all mingled together in the great American melting pot—could they produce within a few generations other than a composite array of architecture, most any part of which might seem dead and without eulogy were one to consider it separate from the whole conglomerate?

That such an accomplishment as Sullivan's Transportation Building at the World's Fair of 1900 was conceived so that it stood out from the mass of "dead" foreign architecture as a "living, vibrant, pulsating thing," is a bright gleam of hope for the future, but could it ever have been produced without

the heritage from the past? May not such a rare accomplishment by a great artist be the ultimate expectation of years of architectural growth, just as the ripened golden fruit bursts forth from the husks of lower though no less essential stages of growth? American architecture will be living—is now living—even though it may appear to even more than the casual observer to be but an essemblage of barren husks carried over from seasons long past.

So in the university class and drafting rooms where the embryo architect is being nourished and trained, Classicism and other fertilizing elements that are our inheritance from the past, cannot be discarded, even though the material may in itself appear dead and lacking in any potentiality whatsoever. As well try to teach the production of a high grade

of English literature with never a study of Shakespeare or Milton or Ruskin as to ignore the works of Vignola, Palladio and Espouy in seeking to arrive at maturity in architectural design. Only by acquiring a wide vocabulary of words as of forms, composing each respectively into beautiful thoughts and beautiful edifices will a great literature or a great architecture result. To teach this in architecture, an appreciation of the artistic wealth of the past, a knowledge of what to apply, what to discard, what to incorporate into that which will serve not only to symbolize the present civilization, but which will serve toward elevating the people to higher planes—this is the task of the University, that in so doing, architecture may be ever a living art worthily emblematic of the spirit of “Westward-Ho.” R. F.

Building Gilds and Housing in England

(By our Special Correspondent)

THE present position with regard to housing in England was already of sufficient complexity; during the last two months circumstances have arisen which seem likely in this respect to make “confusion worse confounded.” Putting entirely aside for the moment the adverse vote of the House of Lords on Dr. Addison’s complicated “omnibus” scheme I refer here directly to the recent resignation of Mr. Stephen Easten from the position of Director of Production in Housing—a resignation which has brought the whole question of the so-called Gild contract system directly before the public.

Mr. Easten, as has been well remarked, like Mr. Smethurst, represents the democratic and progressive side of the building trade. Both these gentlemen are in sympathy with the legitimate demands of labor and trade unionism—both are men who do not spare themselves in doing public work, in spite of the many and important claims on their time, and both are willing helpers to those in authority, but are driven into opposition by the methods of our Government and its departments. “As far as I am concerned,” said Mr. Easten, “the last straw was the Ministry’s adoption of the ill-advised, blundering and wasteful scheme of gild subsidies. I agree with the gild system *per se* for, after all, it merely means the cooperation of a number of workers in building houses, and who are able to obtain contracts in competition with the private builder. I cannot, however, accept the idea of these gilds being subsidized to such an extent

that they are able to drive ordinary building contractors out of the field. For instance, the employer’s contract exacts a penalty if he exceeds his estimate, but allows a small added profit if he works below it. The Gild contract guarantees the workers 5 per cent. profit even if its estimated cost be doubled in working, there being no penalty whatever. If the Gild saves £100 on a house it actually loses money. If the Gild estimates £1,000 and builds for that sum it makes £50, while if it saves, say, £200, it only receives £40 profit—and if the house costs £1,500 the Gild gets £75. That surely does not make for economy.”

Another point which Mr. Easten drives home is that while the employer is not allowed to offer an inducement to workers other than the usual standard wage of the district, and must not pay for sickness or time lost through bad weather, the Gild contract permits for sickness payment and lost time, etc., which means that the workers naturally flock to the gilds whenever they can. “Summing up,” says Mr. Easten, “it is clear that employers who have pledged themselves to do everything possible to help production of houses are penalized, while the building Trade Unions, which flatly declined to help in any way, are officially subsidized. The result must be that employers will be compelled to give their men all that the Gilds now offer, which obviously means a heavy increase in building costs. Be sure,” he adds, “that employers will fight for the right to live, whatever the Ministry of Health may do. To make mat-

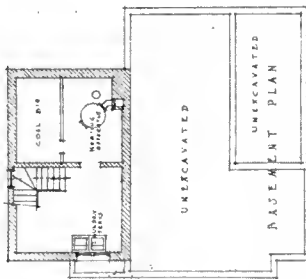
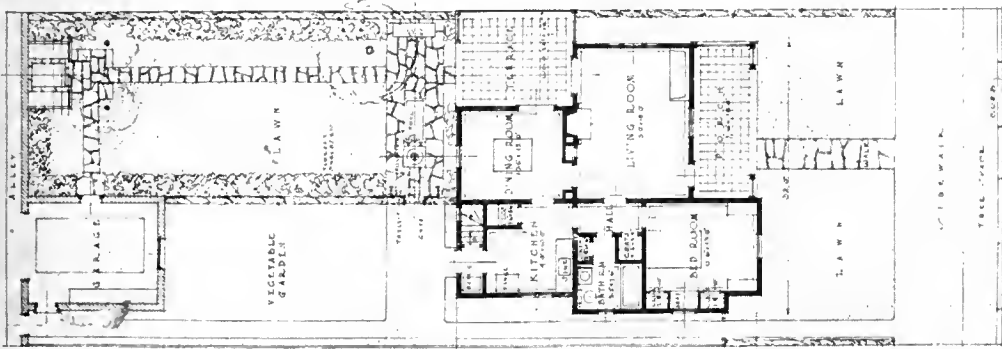

CUBIC CONTENTS

LIVING ROOM, BATH	6720
HALL, P.C. STAIRS	6720
FRONT PART OF BED ROOM, 12'6" x 11'5"	1360
DINING ROOM AND KITCHEN 22'8" x 10'6" x 11'5"	2428
PORCH 7'4" x 15'5" x 11'5"	902
TOTAL	14830

NOTES

- WEATHER BOARDING TO BE 1/2"
- WISE, ROOF TO BE SPRINGE,
- STAINED A DULL GREEN, SHUTTERS PAINTED POTTLE GREEN,
- ALL OTHER WOODWORK WHITE

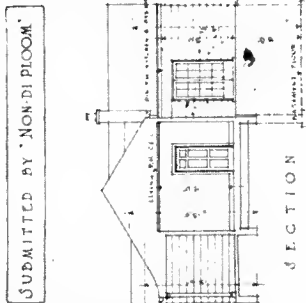

SUBMITTED BY - NON-DIPLOOM

OWN YOUR HOME COMPETITION - FIRST STAGE - FOUR ROOM FRAME

LOUIS JUSTEMENT ARCHITECT,
725 15TH STREET, N.W.,
WASHINGTON, D. C.

Copyright, Own a Home Exposition, Inc.
FIRST PRIZE

FRAME HOUSE
"OWN YOUR HOME" - SMALL HOUSE COMPETITION

LOUIS JUSTEMENT

THE AMERICAN ARCHITECT

ters worse, all this muddling and waste has been in the face of repeated cautions from the Ministry's own experts, whose advice to Dr. Allison has fallen on deaf ears."

This is a serious charge, and one which the Ministry of Health could not afford to overlook. In defending their housing efforts they describe the Guild Contract as an alternative method, of which "representatives of labor have claimed that good results from the point of view of output and economy would be secured by labor undertaking to build on a co-operative basis. The Ministry of Health decided to put this claim to the test, but in view of the novelty of the proposal and the absence of experience it was thought necessary to limit the experiment for the time being, and therefore only a limited number of schemes in various parts of the country have been approved. The number of houses in gild proposals is approximately 1,500, as compared with the total of 167,168 for which tenders have been approved. The schemes have not been long in operation, but already the experience shows that the output compares favorably with that on other schemes, and that the costs promise to be lower than on many other schemes.

TO sum up: the Ministry states—"the Guild system is an experiment being tried on a strictly limited scale as a means of securing the increased output and reasonable costs which have not been secured through building contracts. It is being carefully watched and results tabulated."

Here, then, are two statements which are absolutely at variance; and it may be interesting to see what outside opinion is on this point.

"It is singular," says *The Architect*, "that Mr. Easten, who has had considerable experience in these matters, should be utterly and entirely wrong.

. . . . Mr. Easten, himself a great contractor, who has everything to lose by the success of the gild movement, applies no hard words to it. All he claims is that the gilds—as yet untried and experimental—should not be given an unfair advantage over the contractor out of funds provided by the taxpayer. For only those who delight in word-spinning can really think that the so-called gilds—which are not gilds, except in name—are actuated by a desire to do public service, when it is absolutely clear that their motive is a wish to divide the wholly imaginary windfall which they believe falls to the ordinary contractor, in order that their members may secure better pay and conditions than fall to the workers employed by the contractor. When this fallacy is exploded—as it must be—by the test of trial, the gilds will be wound up, and the completion of their unfinished work handed

over to the despised contractor. Meanwhile, we feel, with Mr. Easten, the absolute injustice of subsidizing the untried gilds at the expense of the contractor."

Even stronger is the criticism expressed by "*The Daily Telegraph*," in a two-column leader early in this year. "Apparently, the Ministry of Health, instigated by motives which have not been confessed, is determined to establish gilds without regard to public economy or the welfare of the building industry, in which tens of thousands of workers are concerned. The facts are simple, and, as far as we know, undisputed. On the one hand the private employer's contract contains a clause penalizing him if he exceeds his estimate, and assuring him a small additional profit if below it. That is a business-like arrangement. What are the terms conceded to the gilds? Mr. Easten's statement has not been controverted." (The writer then quotes the statement which will be found at the beginning of this notice, commencing with the words, "The Guild contract guarantees") "That is a form of contract which makes definitely for waste of the taxpayers' or rate payers' money. The employers' contract allows him 1½ per cent. for establishment charges, but the gild is conceded 6 per cent., and in addition is permitted to pay for lost time and sickness, and offer any other inducement to the workers. The result of this inequitable arrangement must be that the most expert workers will stampede from the ordinary contractor to the gilds, with their tempting baits, the bill for which is to be paid by this already heavily burdened country. Without a 'by your leave' either from the nation or from Parliament, Dr. Addison is instituting a system of whole-time payment, in association with other bribes, which as Mr. Easten suggests, 'may absolutely revolutionize the whole industry of the country.' Whether it rains or snows, and whether the men engaged in house-building be in good health or bad, full payment is to be made to them under this gild system, and the charge is to be met out of the pockets of the community generally. We hope we are wrong in suggesting that the country is confronted with a conspiracy to undermine the foundations upon which British industry has hitherto rested in order to experiment with a Socialistic scheme, but there are grounds for that suspicion."

"*The Daily Telegraph*" is undoubtedly one of the most influential journals in this country, and the lines above quoted amount to a direct challenge on this particular issue to the Government policy of muddle and waste—a policy which has since then received a direct rebuke in the recent Dover election, fought clean through on the platform of "anti-

THE AMERICAN ARCHITECT

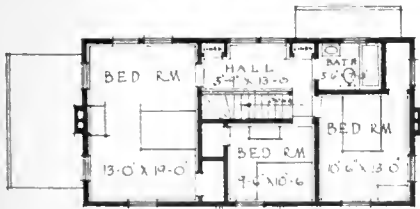
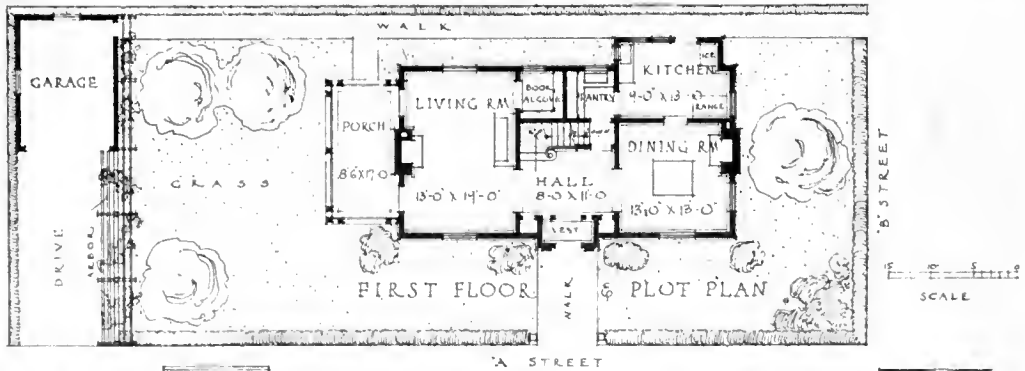

SECOND FLOOR PLAN

NOTES
 ALL EXTERIOR WOODWORK EXCEPT SHUTTERS
 PAINTED WHITE - SHUTTERS EMERALD GREEN -
 BRICK CHIMNEYS PAINTED WHITE, BLACK CAPS.
 SHINGLE ROOF STAINED TOBACCO BROWN

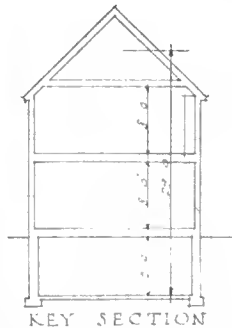

KEY SECTION

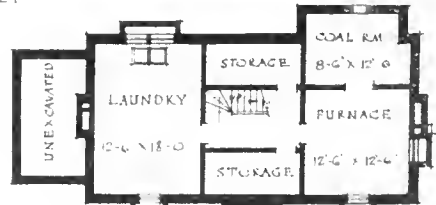

BASEMENT PLAN

A = 20'0" x 39'0" x 24'0" = 22,420 sq ft
 B = 10'6" x 17'0" x 10'0" = 722 sq ft
 C = 4'0" x 12'6" x 10'0" = 375 sq ft
 TOTAL = 23,717 sq ft

DESIGN FOR A 6-ROOM HOUSE IN WOOD

Copyright, Own a Home Exposition, Inc.

SECOND PRIZE

FRAME HOUSE

J. IVAN DISE AND E. J. MAIER

"OWN YOUR HOME"—SMALL HOUSE COMPETITION

THE AMERICAN ARCHITECT

waste." But I attach as much importance to the expression of opinion of "The Architect"—all the more as I have more than once had the opportunity of discussing this question with its editor, and must express here my obligation to his suggestions, with which I find myself in entire sympathy. There are two bodies of men among whom such a movement as the Builders' Guilds has evoked enthusiasm. The worker believes that his wages will be higher by eliminating the contractor, because he thinks there will then be a large additional fund to be divided between those employed on a given contract. The enthusiastic section of the public may believe that the workman, permeated with zeal to perform public service to the community, will work as he had never worked before, and that we may be on the edge of a golden era in building which will recall the great mediæval epoch. But those who look at this matter from the standpoint of past experience recall few instances in which the working classes were inspired by a burning desire to benefit the public, while they are also aware that many contracts are carried out without actual profit, and sometimes even at a loss to the contractor.

The fact is, I believe, incontestable that the smaller class of builders previous to 1910, when the Finance Act was passed, built houses for the working classes here mostly at cost price. They were enabled to do this because they sold undeveloped land at a profit, which was the only profit they often obtained, and one which, under the Increment Duty of the Finance Act, was taxed, thus putting an end to speculation, as the Government, while claiming a share in the profits of the contractor, when he made any, did not pay a portion of his losses when, as was frequently the case, he lost money on the transaction.

FROM first to last the smaller speculative builder housed the people at cost price, without recourse to State aid; if the workers were not sufficiently well-housed they at least got what they required without assistance from the State. The system was one which, imperfect in theory, was effective in practice, while it was capable of much improvement by the simple method of stiffening local

enactments to secure good building, and while there was no reason why local authorities should not have controlled, and insisted upon, the proper development of estates. The better contractors employed on ordinary contracts sometimes made a good profit, but often none or a loss; in the former case, the public gained the benefit of his capital expenditure, in the latter his financial position usually enabled him to face his losses. The average contractor's profit, after deducting expenses, probably seldom exceeded 10%, and was more often 7%, or even 5%.

The contractor's business was always to organize so as to eliminate waste, and his success was dependent on the efficiency of his organization.

That the so-called guilds are likely to equal the success of the skilled contractor in administration is not likely. Supervision will be in a larger number of comparatively untrained hands, while it is probable that the control of the workers, under such a democratic system, will be neither as effective nor as thorough as in that of the contractor. If this should prove the case the 5%, 7% or 10% which the contractor makes when successful will partially or wholly disappear, if indeed this is not turned into an actual loss.

But since the guild has no accumulated funds to start with it must then either cease work or receive, like our railways, telephones, and post office, the amount of the deficit from the State. And while the contractor takes work at a fixed sum, and his profit is only obtained if he works within this sum, the guilds are to receive, as we have seen, a fixed rate of remuneration for all work, whatever it costs, while they are to be paid the actual costs of the work carried out by them. What are, in fact, their so-called estimates save the expression of a pious hope on the part of men who have no actual experience in administration or finance, and no capital on which to work?

For the reasons above stated it is to be feared that this whole system of building guilds, with its proposal to distribute profits among those employed, may, in actual working, only turn out another of the burst bubbles which have characterized the attempts of Government to revolutionize the conditions of a complicated industry.

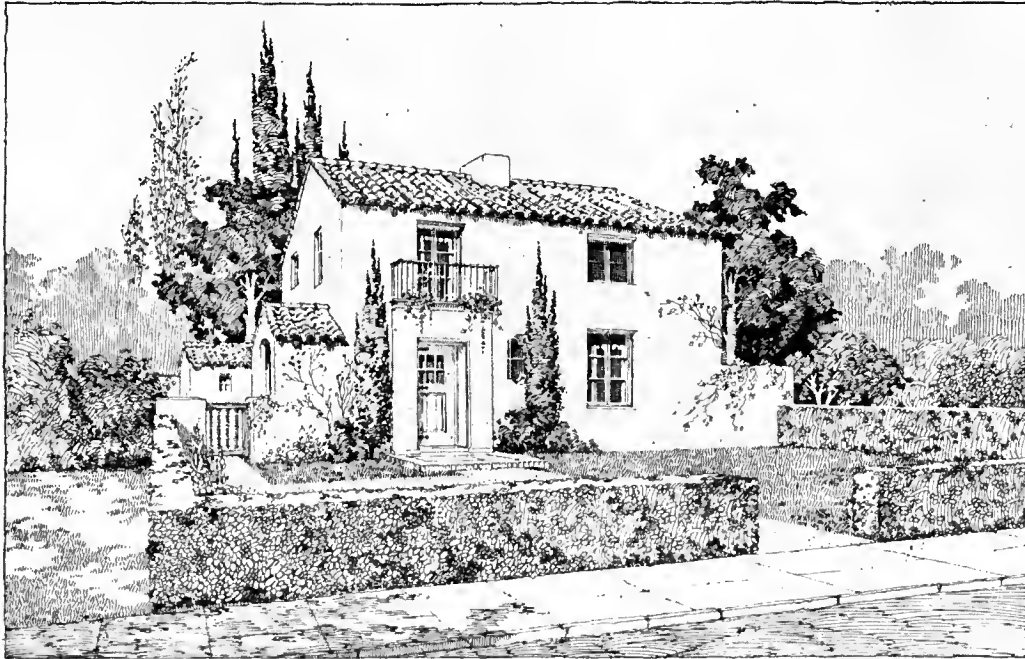

CUBIC CONTENTS

HOUSE 27'6" x 22'0" x 10'6" 16032
 REAR PORCH 40'8" x 4' 672
 SIDE PORCH 40'8" x 4' 674
 TOTAL 16968

NOTES

EXTERIOR STUCCO TO BE FINISHED SMOOTH COLORED WHITE. EXTERIOR WOODWORK PAINTED A LIGHT GRAY-BLUE IRON WORK PAINTED BLACK. ROOF TO BE OF RED MISSISSIPPI TILE. MECHANICAL UNIFORMITY TO BE AVOIDED IN WALL AND ROOF.

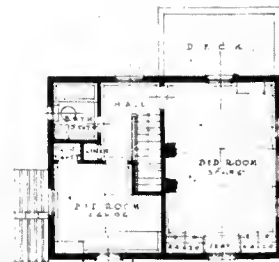
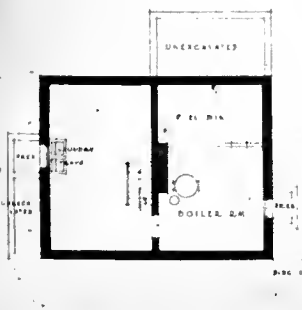
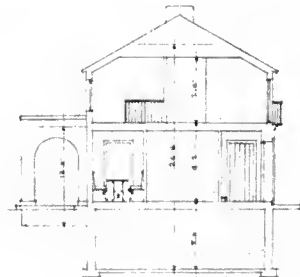
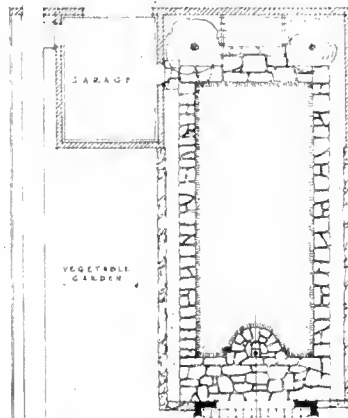

SUBMITTED BY
 "AT THE DISCRETION
 OF THE JURY"

OWN YOUR OWN HOME
 COMPETITION
 FIRST STAGE
 FOUR ROOM STUCCO

LOUIS JUSTEMENT, ARCHITECT,
 704 15TH ST., N.E.,
 WASHINGTON, D. C.

© BUILDING PLAN BOARD OF CONSTRUCTION,
 102 WEST 42ND ST., N. Y.

Copyright, Own a Home Exposition, Inc.

FIRST PRIZE

STUCCO HOUSE

LOUIS JUSTEMENT

"OWN YOUR HOME"—SMALL HOUSE COMPETITION

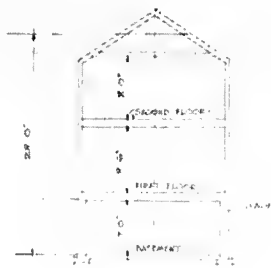

SECTION

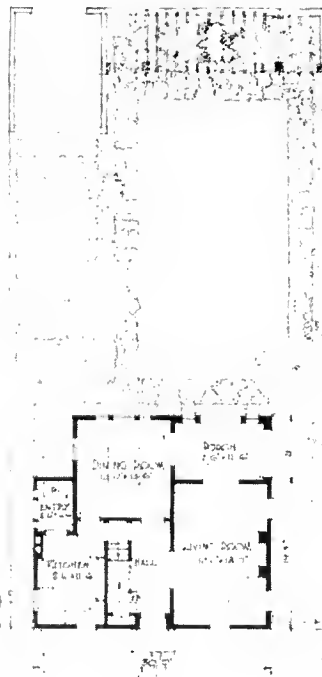

FIRST FLOOR PLAN

CUBAGE

	CU. FT.
MAIN HOUSE	16380
DINING ROOM WING	3534
PORCH	1200
TOTAL	21114

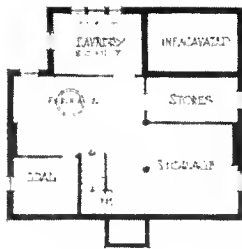

BASEMENT PLAN

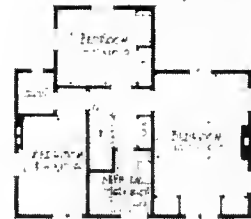

SECOND FLOOR PLAN

Copyright, Owen a Home Exposition, Inc.

SECOND PRIZE

STUCCO HOUSE
"OWN YOUR HOME"—SMALL HOUSE COMPETITION

AMEDO LEONE

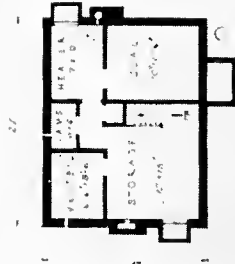

PERSPECTIVE VIEW

HOUSE TO BE BUILT OF BRICK
WITH WOOD TRIMMINGS PAINTED WHITE
AND ROOF PAINTED DARK RED

CUBAGE

BRICK HOUSE	21,272.00
POORCH	302.60
PAT.	3,550.00
TOTAL	25,124.60

OWN YOUR HOME COMPETITION
DESIGN FOR A FOUR ROOM HOUSE

JOSEPH W. COOK, ARCHITECT,
235 WEST 11TH ST.,
NEW YORK, N. Y.

© BRIDGE AND SALOMONSKY, ARCHITECTS,
235 WEST 11TH ST., N. Y.

Copyright, Open a Home Exposition, Inc.
FIRST PRIZE

BRICK HOUSE
"OWN YOUR HOME"—SMALL HOUSE COMPETITION
EDGAR AND VERA COOK SALOMONSKY

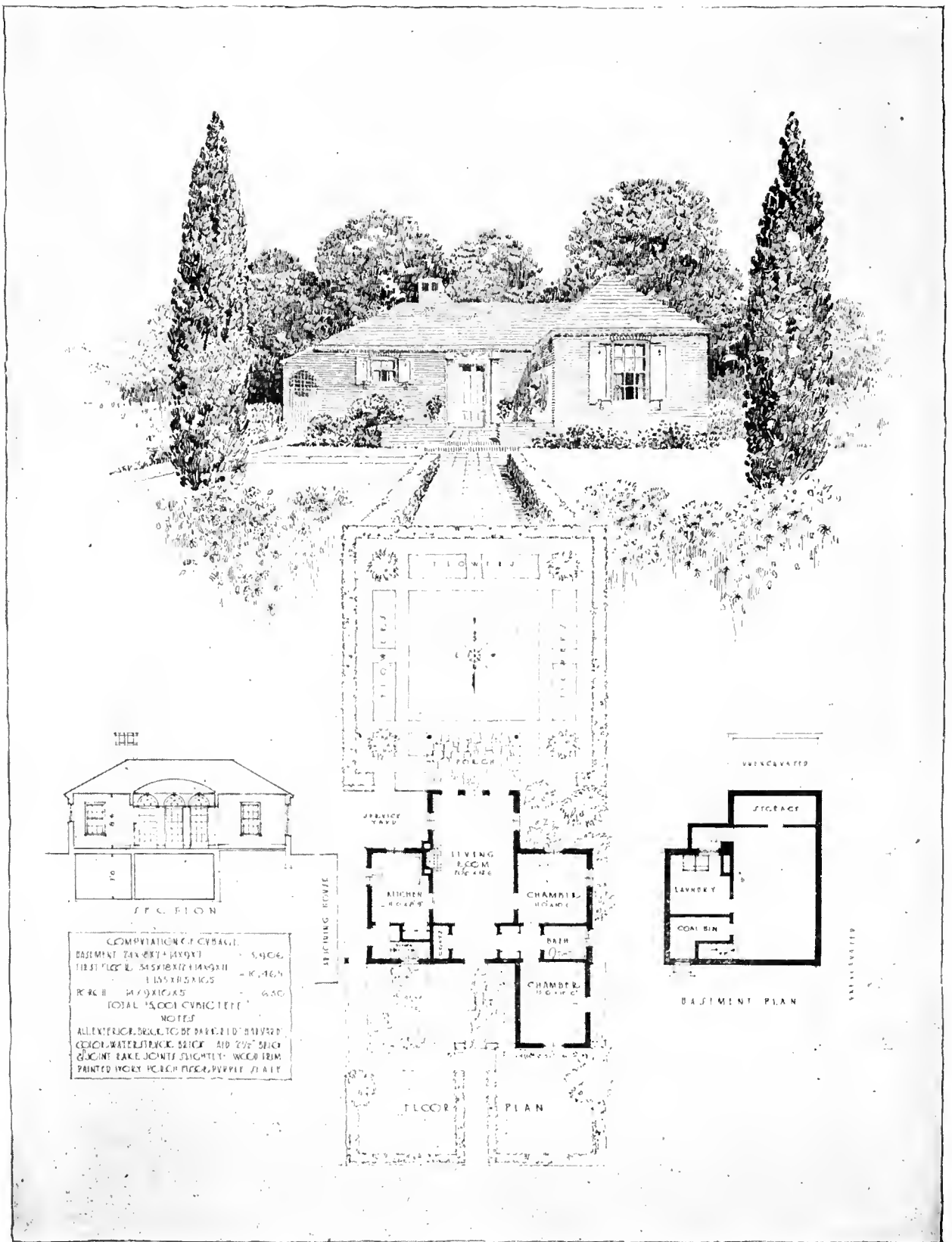

Copyright, Own a Home Exposition, Inc.

SECOND PRIZE

BRICK HOUSE

JOHN BARNARD

"OWN YOUR HOME"—SMALL HOUSE COMPETITION

Beaux-Arts Institute of Design

DIRECTOR OF THE INSTITUTE, LLOYD WARREN

ARCHITECTURE, RAYMOND M. HOOD
SCULPTURE, JOHN GREGORY

INTERIOR DECORATION, ERNEST F. TYLER
MURAL PAINTING, ERNEST C. PEIXOTTO

Official Notification of Awards—Judgment of December 14, 1920.

PROGRAM

CLASS "B"—I ANALYTIQUE.

The Committee on Architecture proposes as subject of this Competition:

"THE SIDE ENTRANCE TO A CHURCH."

A Catholic church, situated on a plot bounded by four public streets, has been left with its side elevations unfinished, due to the lack of necessary funds at the time of the original construction. The architecture of the church as it stands is Renaissance, and it is now proposed to finish the exterior of the right transept wall and the transept entrance. The latter is the subject of this program.

The problem requires the study of an architectural composition, complete in itself, of solemn dignity, and properly accentuating the secondary entrance against the transept wall. The door opening shall be 8 feet in width, which is the sole limitation of the problem. Such a door is usually treated with the ordinary classic elements—that is to say, columns, pilasters, pediments, niches, statuary, etc. In this problem the development of the motive is left entirely to the discretion of the student, save that account should be taken of the architectural treatment of the transept as a whole. Examples of such entrances occur in nearly all of the Renaissance churches in Italy and France.

JURY OF AWARD:

P. A. Cusachs, L. Warren, G. A. Licht, W. K. Rainsford, A. E. Flanagan and T. S. Holden.

NUMBER OF DRAWINGS: 167

AWARDS:

First Mention Placed: P. C. Reed, M. D. Smith, C. F. Bowers, H. A. Page, J. Franklin, A. Taermina and R. Patterson, Carnegie Inst. of Tech., Pitts.; E. N. Kaeyer and A. G. Bagley, Columbia Univ., N. Y. C.; W. Harris, George Washington Univ., Wash., D. C.; J. C. Peyton, Atelier Hiron, N. Y. C.

First Mention: M. J. Bert, J. W. Fritz, D. D. McGervey, P. Hohorst, P. F. McLean, B. H. Lawson and C. E. Landefeld, Carnegie Inst. of Tech., Pitts.; A. Perrella, Columbia Univ., N. Y. C.; L. G. Clark and H. W. Naylor, Atelier Hiron, N. Y. C.; E. Olsen and P. R. Rudolph, Atelier Parsons-Chic. A. C., Chicago; H. D. Baker, Princeton Univ.-Graduate Col., Princeton; F. M. Garey, Richmond Archtl. Club, Richmond, Va.; C. R. Ferris, Syracuse Univ., Syracuse; R. Carter and H. Richardson, Univ. of Washington, Seattle; A. G. Clay, Yale Univ.-Sch. of Fine Arts, New Haven.

Mention: L. Ross, H. R. Burger and J. M. Brown, Atelier Atherton, Wilkesbarre; F. W. Clarke, Atelier Birmingham, Birmingham, Alabama; H. H. Price, H. R. Hall, J. A. McPherson, J. H. Shea and T. F. McDonough, Boston Archtl. Club, Boston; L. C. Page, H. C. Kreisle, M. C. Usan, H. W. Lefkowitz, H. C. Douden, L. L. Broida, V. H. Stromquist, W. J. Bane, J. H. Delo, C. C. Agill, C. J. Billmeyer, H. Carter, W. H. Willis, M. Dyer, W. M. Burke, J. M. Lanese, F. B. Smith, G. A. Brink, K. Snyder and G. A. Fister, Carnegie Inst. of Tech., Pitts.; A. O. Angilly, V. Sberna, I. Tron, J. L. Barth, J. M. Paul, I. Trinin, A. A. Ehrenrich and S. Blank, Columbia Univ., N. Y. C.; V. Pribil, F. D. V. Martinelli, C. Jensen and C. Forrester, Atelier Cor-

bett-Gugler, N. Y. C.; C. E. Bieler, C. H. Kellogg and W. H. Speer, Atelier Denver, Denver; J. H. Lapish; F. L. Soars, F. A. Elliott and T. S. Brown, Geo. Washington Univ., Wash., D. C.; J. W. Hanson, Atelier Hiron, N. Y. C.; F. M. Manker, Archtl. League of Indianapolis, Indianapolis; W. A. Jaeger, E. Horley, K. Steinbach, H. P. Whitworth and N. O. Matson, John Huntington Poly. Inst., Cleveland; W. W. Mezger, Los Angeles Archtl. Club, Los Angeles; C. R. Schmidt, 7 W. 42nd St., N. Y. C.; R. L. Morin, 38 W. 54th St., N. Y. C.; H. W. Smith, Atelier Owsley, Youngstown; H. Silverman, Atelier Licht, N. Y. C.; G. M. Nedved, E. A. Gylleck, A. R. Brown, R. H. Johnson, D. R. Lundberg and T. Ross, Atelier Parsons-Chic. A. C., Chicago; D. A. Campbell, W. W. Ullery and H. E. Dickson, Pennsylvania State College, State College; F. A. Comstock, Princeton Univ.-Graduate Col., Princeton; E. W. Niblet, E. R. Gilbert and L. C. Palmer, Richmond Archtl. Club, Richmond, Va.; B. C. deMello, C. I. Cromwell, W. P. Crabtree, Jr., P. W. Becker, A. F. Eldridge, R. R. Bridges and G. F. Bennett, Syracuse Univ., Syracuse; E. Green, Jr., Swain Free Sch. of Design, New Bedford; C. A. Langzettel, W. W. Haslett, A. B. Bowen, H. Shaw, L. Hauf, Jr., and F. Raudenbush, "T" Square Club, Phila.; E. M. Robison and J. H. Compton, Univ. of Kansas, Lawrence; V. C. Edades, V. L. Annis, D. T. Lopp, H. Schippmann, J. Bonnell, E. R. Duckering, A. E. Fulton, J. C. Jordon, Elizabeth Ayer, V. N. Jones, W. W. Lund and C. W. Haas, Univ. of Washington, Seattle; B. H. O'Connor, Univ. of Texas, Austin; G. Koepf and C. Wilson, Univ. of Oregon, Eugene; G. K. Wenzell, Univ. of Southern California, Los Angeles; R. D. Kelly, A. D. Johnson, W. Yungbauer and C. K. Frensz, Univ. of Minnesota, Minneapolis; A. Harrer, Atelier Wynkoop, N. Y. C.; S. N. Alderman, P. E. Isbell and M. H. Pardo, Yale Univ.-Sch. of Fine Arts, New Haven; A. H. Miller, Thumb Tack Club, Detroit.

H. C.: R. G. Caldwell, Archtl. League of Indianapolis, Indianapolis; W. E. Herrick, Atelier Wynkoop, N. Y. C.

PROGRAM

CLASS "B"—I PROJET.

The Committee on Architecture proposes as subject of this Competition:

"A SMALL PRIVATE CHAPEL ON A COUNTRY ESTATE."

In many countries men have been found who, prompted by devotion, built private chapels on their estates. In this project such a chapel is supposed to be directly connected with the residence group which is formed about a court. The circulation between the adjoining sections of the residence is maintained by means of a cloister or connecting passageway. The entrance to the chapel is through the cloister, which acts as a porch.

Whatever style may be assumed, its character should be decidedly domestic, and as the chapel is not the dominant building of the group, its architectural development should be restrained. It will be used not only by the family, but also by the servants.

The greatest dimension of the chapel, exclusive of the cloister, shall not exceed 50 feet.

W. M. M. ★

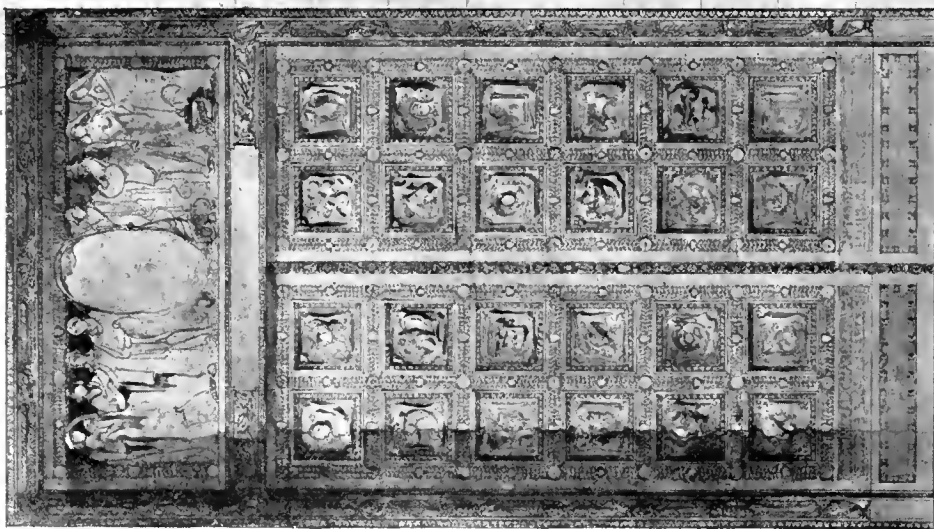

A PAIR OF BRONZE DOORS

THE EMPEROR OF THE
GREAT EASTERN
ORIENTAL CO.

G. FRASER CORNELL UNIVERSITY

G. FRASER

FIRST MEDAL

T. SQUARE CLUB

EMERSON PRIZE COMPETITION. A PAIR OF BRONZE DOORS

STUDENT WORK—BEAUX-ARTS INSTITUTE OF DESIGN

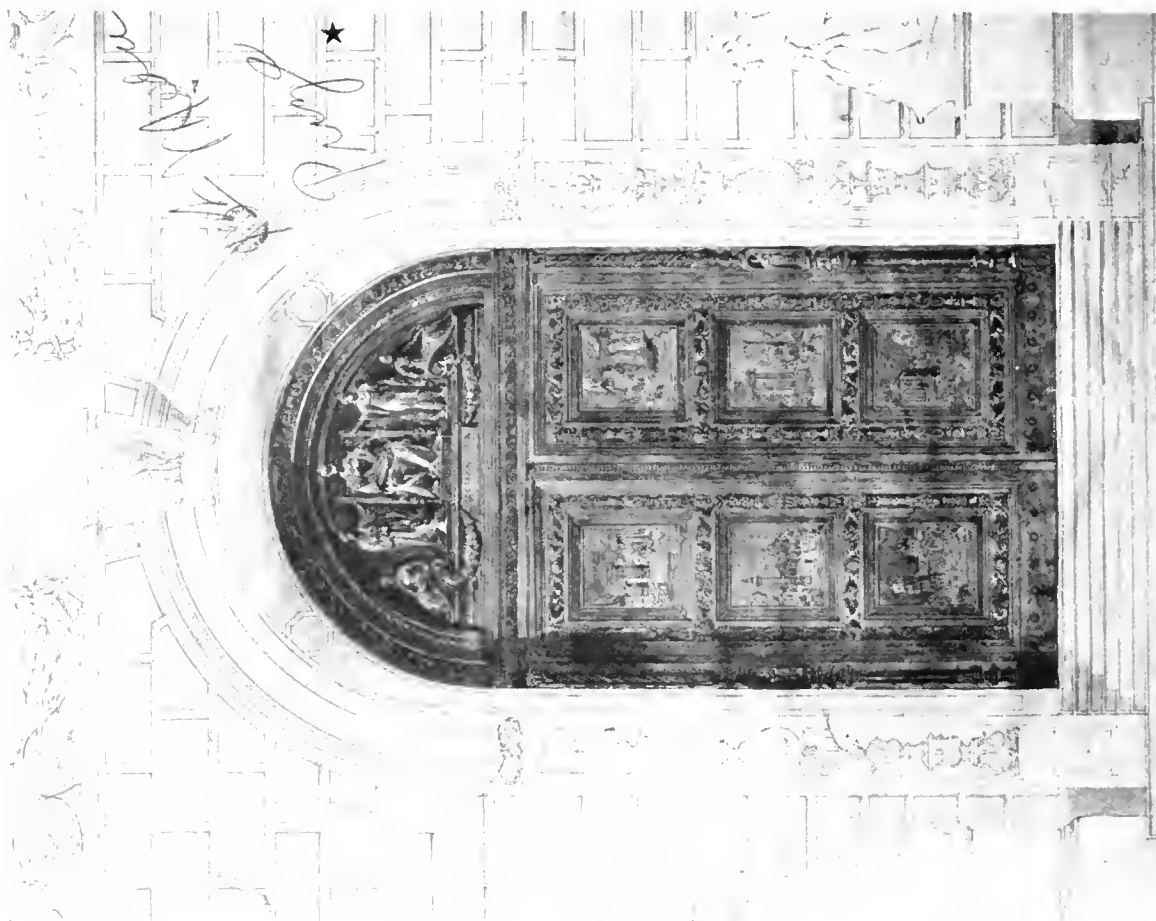

W. M. M. ★

FIRST PRIZE AND FIRST MEDAL

R. NICKEL

T. SQUARE CLUB

EMERSON PRIZE COMPETITION. A PAIR OF BRONZE DOORS

STUDENT WORK—BEAUX-ARTS INSTITUTE OF DESIGN

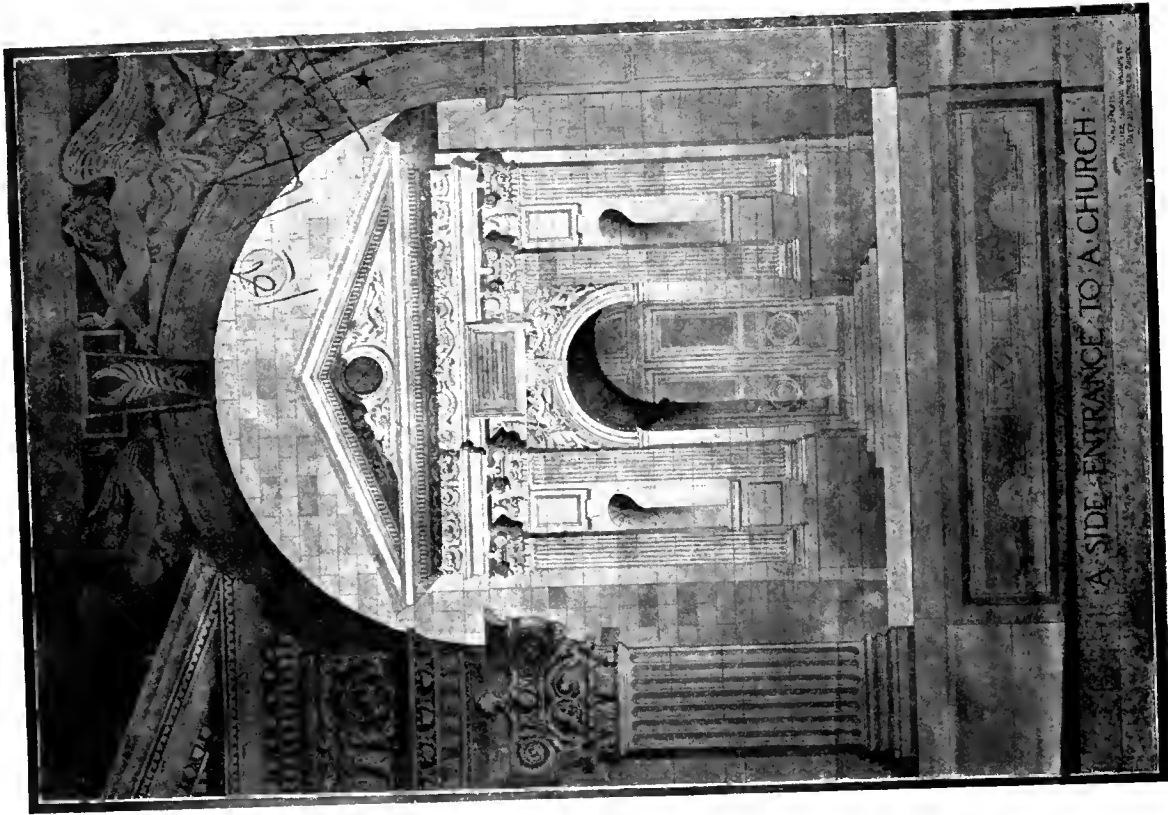

GEORGE WASHINGTON UNIV

W. HARRIS

FIRST MENTION PLACED

COLUMBIA UNIV. CLASS "B"-I. ANALYTIQUE. THE SIDE ENTRANCE OF A CHURCH

STUDENT WORK - BEAUX-ARTS INSTITUTE OF DESIGN

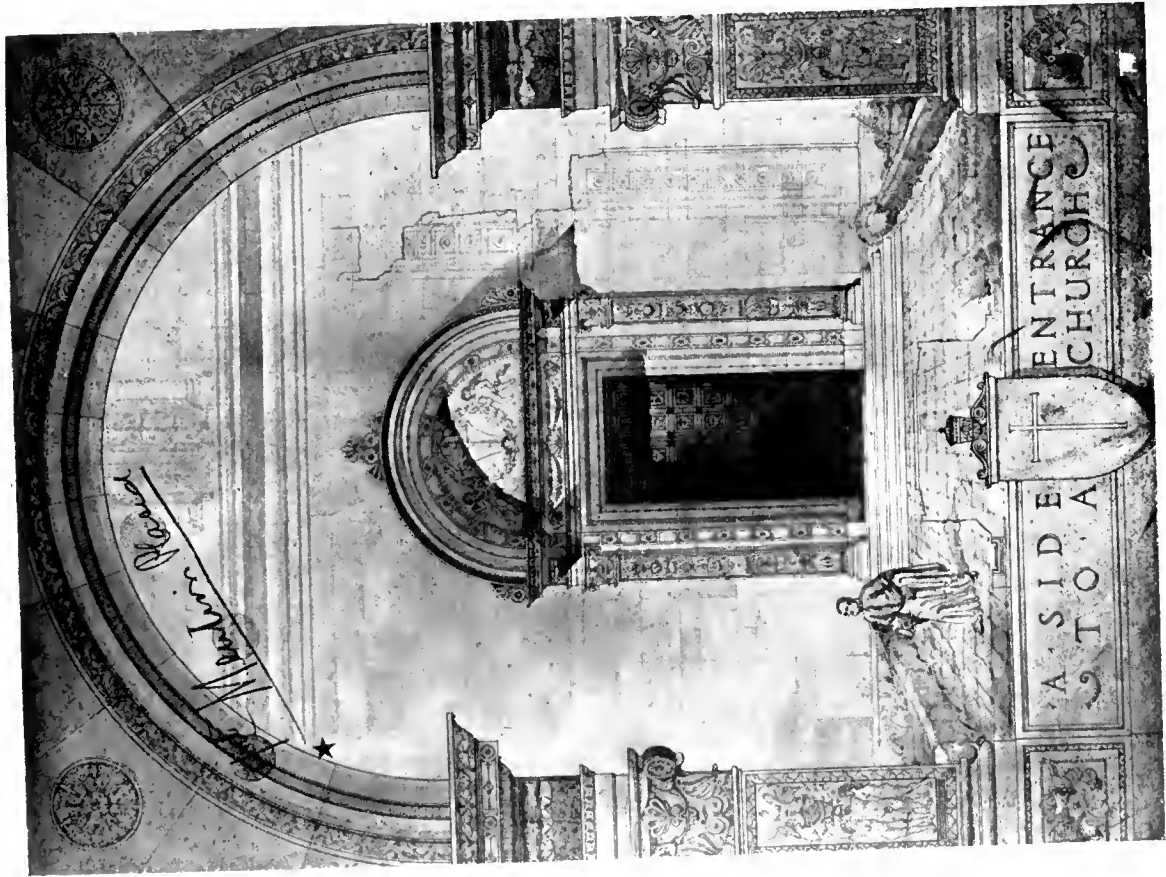

A. G. BAGLEY

COLUMBIA UNIV.

FIRST MENTION PLACED

CLASS "B"-I. ANALYTIQUE. THE SIDE ENTRANCE OF A CHURCH

STUDENT WORK - BEAUX-ARTS INSTITUTE OF DESIGN

THE AMERICAN ARCHITECT

JURY OF AWARD:

R. M. Hood, B. W. Morris, H. O. Milliken, W. L. Bottomley, H. R. Sedgwick, F. C. Hiron, H. W. Corbett, E. A. Dennison, F. L. Ackerman, S. Stevens, J. F. Harbeson and A. DiNardo.

NUMBER OF DRAWINGS: 129

AWARDS:

First Mention Placed: R. L. Linder, Atelier Denver, Denver; A. C. Baker, Dallas Archtl. Club, Dallas; E. Olsen and H. Van Der Lyn, Atelier Hiron, N. Y. C.; G. Chittenden, Los Angeles A. C., Los Angeles; A. A. dePorreca, "T" Square Club, Phila.; A. E. Evans, Univ. of Kansas, Lawrence; P. J. Bitterman, Jr., 551 Knickerbocker Ave., Brooklyn, N. Y.

First Mention: L. T. Pancoast, Cornell Univ., Ithaca; E. M. Highberger, C. J. Pellegrini and C. B. Marks, Carnegie Inst. of Tech., Pitts.; J. A. Williamson, Dallas Archtl. Club, Dallas; L. Rombotis, Los Angeles A. C., Los Angeles; G. H. Levy, 6 E. 107th St., N. Y. C.; J. A. Fletcher, C. G. Thalheimer, J. H. Geissel and W. R. Fisher, "T" Square Club, Phila.

Mention: M. E. Witmer, Boston A. C., Boston; E. F. Sibbert, Jr., L. B. Pickwick, G. W. Teare, E. A. Hart, L. H. Denler and G. B. Howell, Cornell Univ., Ithaca; A. M. Taylor, K. Matsunci, W. H. Kraemer, C. H. Dornhusch, W. Conley and P. Simonsen, Columbia Univ., N. Y. C.; W. M. Dowling and P. H. Smith, Atelier Corbett-Gugler, N. Y. C.; R. Mira, L. F. LaPorte and E. J. Rutledge, Catholic Univ., Wash., D. C.; L. B. Christman, W. L. Gibb, Jr., H. E. Rudy, L. H. Rank, T. G. Tiffany, K. B. Weber, J. O. Cahill, E. F. Hughes, A. W. Chesterman, E. O. Schoonover, A. A. Lewis, B. A. Hamilton, R. V. Murison, L. L. Nusbaum, J. G. Todd, F. H. Floyd, E. W. Klee and J. W. Minick, Carnegie Inst. of Tech., Pitts.; J. F. Smith and H. M. Burnham, Georgia Sch. of Tech., Atlanta; G. A. Daidy, George Washington Univ., Wash., D. C.; E. E. Davenport, Archtl. League of Indianapolis, Indianapolis; E. L. Babitsky, J. E. Miller and E. C. Rising, John Juntington Poly. Inst., Cleveland; P. Goodman, Atelier Licht, N. Y. C.; C. V. Bert, H. R. Gamble, L. L. Wallace, Jr., and H. T. Hamel, Pennsylvania State College, State College; A. Gambell, Portland A. C., Portland, O.; G. McCormick, R. W. Bauhan and H. J. Burden, Princeton Univ.-Graduate Col., Princeton; F. K. Cheetham, J. Schierhorn and G. S. Beach, Atelier Parsons-Chic. A. C., Chicago; E. R. DeShaw, R. H. Doman and M. V. Dittmar, Syracuse Univ., Syracuse; J. J. Welsh, Swain Free Sch. of Design, New Bedford; H. T. Plumer, E. S. Young and E. A. Beihl, "T" Square Club, Phila.; D. K. Frohwerk and F. R. Hibbs, Univ. of Kansas, Lawrence; H. C. Heath and R. L. White, Univ. of Texas, Austin; Doris A. Siebert, Univ. of Washington, Seattle; V. Carlson Univ. of Minnesota, Minneapolis; A. H. Goddard, L. B. Wamnes and E. Penfield, Atelier Wynkoop N. Y. C.; D. Weinstein, C. B. Lewis and D. M. Campbell, Yale Univ.-Sch. of Fine Arts, New Haven.

H. C.: J. Truden, Atelier Corbett-Gugler, N. Y. C.; L. E. Considine, Carnegie Inst. of Tech., Pitts.; G. H.

Gibson, Georgia Sch. of Tech., Atlanta; F. O. Paul, Pennsylvania State College, State College; C. H. Siebert, Syracuse Univ., Syracuse; A. A. Graves, R. W. Kerfoot, H. F. Neville and R. B. Bloomgarten, Univ. of Kansas, Lawrence; Rosalie Haas, Univ. of Washington, Seattle; B. S. Georges, H. S. Kelly and W. Douglas, Yale Univ.-Sch. of Fine Arts, New Haven.

THE EMERSON PRIZE.

The gift of Professor William Emerson, offered for the best solution of a decorative problem.

PRIZE—\$50.00.

(For conditions governing this Prize Competition, see Circular of Information, Article VIII, Par. 4.)

PROGRAM

The Committee on Architecture proposes as subject of this Competition:

"A PAIR OF BRONZE DOORS."

These doors are destined for the main entrance of a large art museum, the stone opening of which is 9 feet wide and 16 feet high. To facilitate the operation of the doors, it is desirable to cut down their height and weight. At the upper portion of the opening, therefore, is to be a fixed panel or grille, which should, however, form a part of the general composition of the doors.

The modern method of sand moulding has been so perfected that it is possible to cast a door in sections, welding these sections together after casting. This permits a depth of modelling and undercutting approximating the effect of the older and more expensive process, known as the lost wax process. In consequence the relief may have all the values, from high lights to deep shadows of undercutting, limited only by the thickness of the doors. The effect may even be supplemented by complete penetration at certain points, if desired.

JURY OF AWARD:

R. M. Hood, B. W. Morris, H. R. Sedgwick, F. L. Ackerman, E. A. Dennison and H. W. Corbett.

NOTE:

H. W. Corbett did not serve on Jury for the awarding of Emerson Prize.

NUMBER OF DRAWINGS SUBMITTED: 17

AWARDS:

Emerson Prize \$50.00: R. Nickel, "T" Square Club, Phila.

First Medal: G. Fraser, Cornell Univ., Ithaca; R. Nickel, "T" Square Club, Phila.

Second Medal: E. K. Hunter, W. H. Harrison, H. G. Spielman and C. M. Stotz, Cornell Univ., Ithaca; R. K. Galbraith, Archtl. League of Indianapolis, Indianapolis, Indianapolis; R. A. Fisher, Univ. of Pennsylvania, Phila.

Mention: H. Banse, M. B. Steinmann, V. S. Swan and F. H. Robinson, Cornell Univ., Ithaca; N. D. Kutchukian, Carnegie Inst. of Tech., Pitts.; A. G. Terrell, Columbia Univ., N. Y. C.; K. A. McGrew, R. S. Potter and L. H. Pries, Univ. of Pennsylvania, Phila.

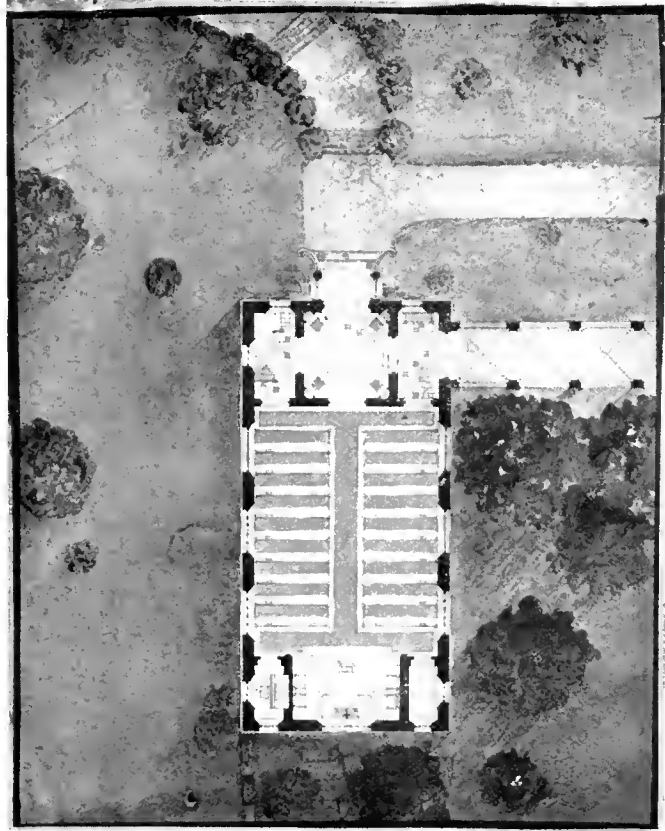
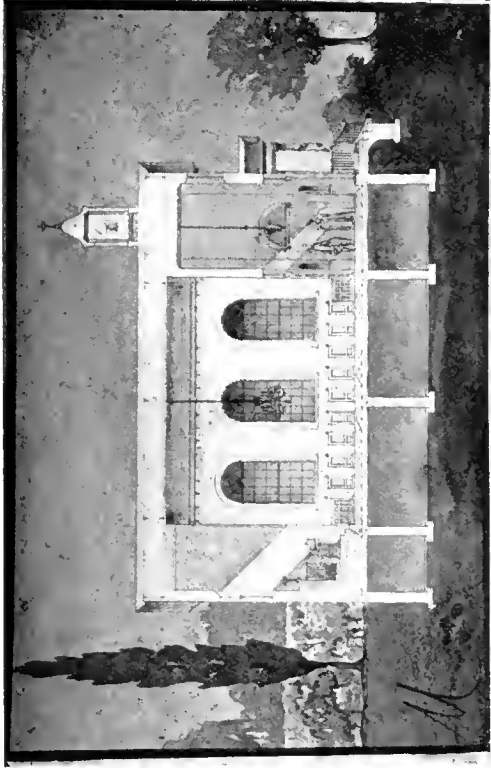

ATELIER HIRONS

H. VAN DER LYN
CLASS "B"-1. PROJET. A SMALL PRIVATE CHAPEL ON A COUNTRY ESTATE
STUDENT WORK—SOCIETY OF BEAUX-ARTS ARCHITECTS

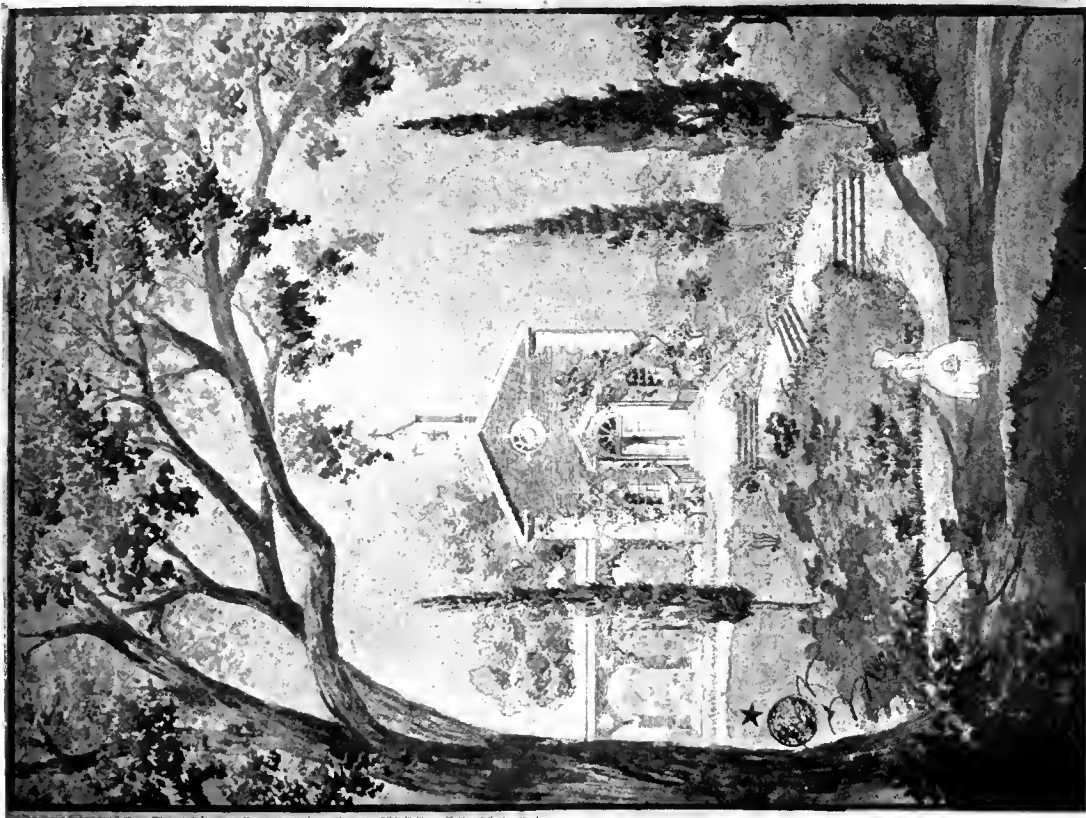

FIRST MENTION PLACED

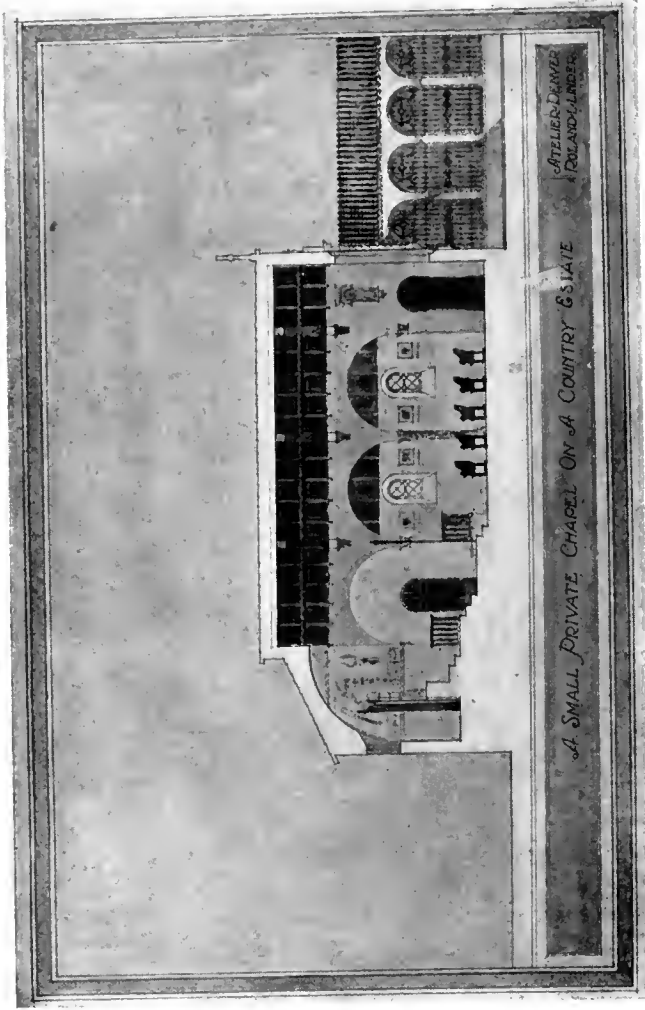
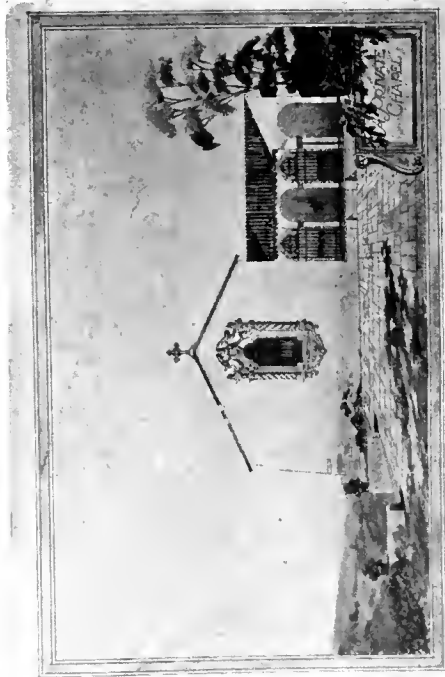

FIRST MENTION PLACED

R. L. LINDER

ATELIER DENVER

CLASS "P"-1. PROJET

A SMALL PRIVATE CHAPEL ON A COUNTRY ESTATE

STUDENT WORK—BEAUX-ARTS INSTITUTE OF DESIGN

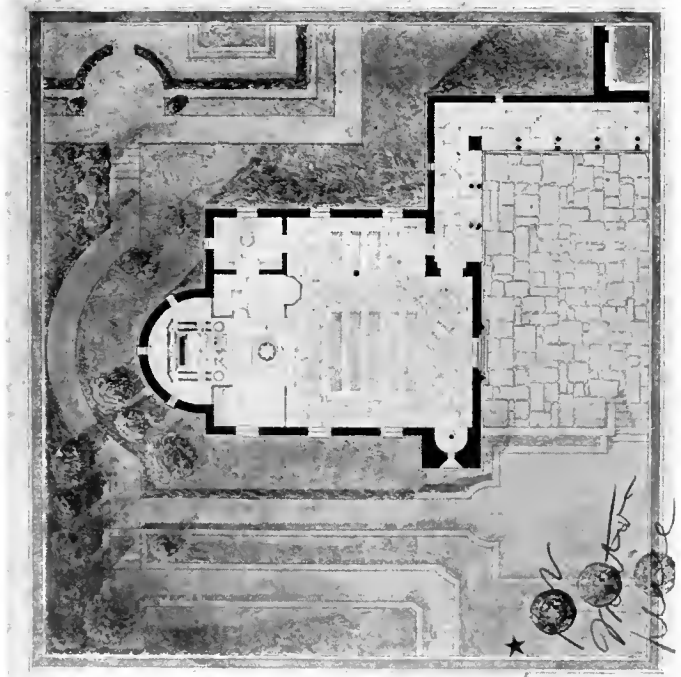

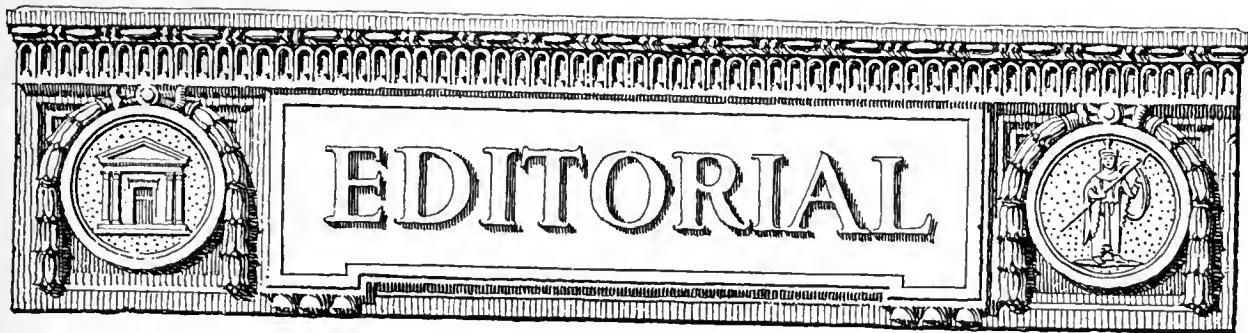

Confidence

WHAT is it that builds houses? Men? Money? Materials? Architects? Engineers? Most assuredly. But what is behind the men and the money and materials and architects and engineers? What is the starting point of it all? Confidence. Assuredness in the future; the dead certainty that things are shaping up properly; the knowledge that the future holds promise of industrial achievement—money-making possibilities.

And what of the future?

The outstanding fact in it, of course, is that our national life is now being guided by a new administration. This is said simply because it stands out as the one predominating fact in the establishment of national confidence.

It is only natural that such should be the case. Human nature is so constituted that change brings stimulation of confidence. A new administration means a new era, in the sense that it puts before the people of a nation limitless possibilities on the part of those chosen by an electorate to run the affairs of that nation.

Everywhere among architects there is the feeling that the time has come to go ahead with things. Spring, with its building activities looming closer and closer, is at hand; and all signs point to a "go ahead" policy among architects.

It is interesting to note that among the many prominent industrial leaders and financiers who speak today of the immediate future with decided confidence are: Thomas W. Lamont, of J. P. Morgan & Co., Elbert H. Gary, Chairman of the United States Steel Corporation; Francis H. Sisson, vice president of the Guaranty Trust Company of New York, and Daniel G. Reid, the financier.

Such is the trend of thought among thoughtful men.

AND what are the physical tendencies of the situation?

Walter Stabler, comptroller of the Metropolitan Life Insurance Company, very recently told the members of the Board of Estimate of New York City

that there had been much more activity noticeable so far as inquiries for loans for building purposes went, since the passage of the tax exemption ordinance of that city (which in itself was almost an insignificant exemption) was passed.

Two million dollars for "walk up" apartments were loaned by Mr. Stabler's company in *one week*.

In Chicago the Corn Exchange National Bank's new "own-your-own-home" accounts campaign produced more than 3,000 inquiries and 300 *accounts* in the *first day*. This was in the last part of January.

In Philadelphia, the City Council has made 15 million dollars immediately available for municipal structures, and Controller Hadley of that city has announced that 100 million dollars' worth of loans authorized and unissued could be put into use if needed.

San Francisco's realty sales for January, 1921, totaled very nearly \$6,000,000. There were 764 sales. These two facts of themselves are of no great importance, but the fact that 6 million dollars and the number of sales is well up to the past year, and that active and result-producing inquiries for real estate remain good, are of importance.

These are isolated cases of large cities, but they indicate the trend of the collective business and industrial mind, and the return of confidence.

In the Third Federal Reserve District the Federal Reserve Bank of Philadelphia points conclusively to a general business improvement by means of official data.

New England's textile industries are nearly "back to normal" and the general business conditions in that section of the country are, therefore, in for rejuvenation, recuperation, and results.

Thus it goes throughout the country. Everywhere there are signs, not of "normalcy" achieved, but of a distinct, definite trend toward that much desired state. It is pleasing and justifiably heartening to note that the thing has gotten under way, and that we are at last headed toward that recuperation of industry which foreshadows the complete industrial confidence so necessary in the great building activities which must take shape this spring.

The American Specification Institute

Shortcomings of Specifications

THE AMERICAN ARCHITECT received recently a letter discussing the subject of specifications, which is here given in part. The writer arrived at his rather tersely expressed opinions through having spent many years as a general contractor's estimator, although his technical training was for the profession of architecture. We may not agree with his opinion of the things that cause the production of unsatisfactory specifications as it is readily understood that a great many things are contributory. It is a statement, however, that may form the basis for thought and discussion. If this is the result, a contribution has been made to this most important subject.

"Specifications that are unsatisfactory to the contractor and ultimately to the architect and owner, are the result of certain factors that influence their waiting. They are:

- Ignorance.
- Indolence.
- Cowardice.
- Knavery.

One or all of these may be the cause, but one at least is present. The degree of badness varies with the number of these elements involved.

The only excuse for ignorance is the lack of available information, which to a great extent is admitted. The data does exist, however, in some form and is procurable. Of ignorance, the inability to write clearly is an important factor. All trained draughtsmen very easily express their ideas by lines and conventional signs that are universally understood. Our schools do not teach us how to express the same ideas in words in as clear and direct a manner. This phase of ignorance can be overcome.

Indolence is a common characteristic, in some degree, to most people. Ignorance is a result of indolence to a great extent and until indolence is eliminated the other will be present. The writing of a specification worthy of being so considered is the result of plain, hard work. The idea that a few hours given to the writing of the specification after the plans are completed is an exploded theory, especially for the modern building embracing so many complex problems.

Cowardice is sometimes the result of ignorance and is a mental characteristic of the specification writer. It is the reason for non-assumption of responsibility in definitely stating the things that the contractor shall provide and do. There is no other business in which direct responsibility is evaded as brazenly and openly as is done in the writing of specifications for building construction. Honesty, frankness and non-evasion are the basis of sound business. A person who is afraid of his own judgment, knowledge and ability cannot possess the courage to produce a satisfactory specification or plan.

Knavery is indicated in specifications that are susceptible of double interpretation. The favored contractor or material producer can have a pre-bidding explanation that insures successful competition in re-

turn for some perquisite. This characteristic is, most happily, much less prevalent than it was two or three decades ago. There is abundant evidence of this."

This will appear to some as a rather harsh indictment of the writer of unsatisfactory specifications, but it is a feeling quite common among those who have devoted their energies to the interpretation of plans and specifications as estimators. It is also the feeling of many who have risked their time and money in constructing structures that were not clearly and adequately defined by specifications and drawings. The building industry, as a whole, will benefit by the elimination of this unsatisfactory factor.

Mr. William B. King, of the Bar of the Court of Claims, Washington, D. C., in a very able and notable address before the recent convention of the Associated General Contractors, discussed this subject, in part, as follows:

"This country is deficient in specifications of material and methods of work. It ought to be possible in the case of almost every material to say that it shall conform to a given grade of fixed and known standards prescribed by a central organization. This would take the place of the old and inexact form, 'Unless otherwise prescribed, all material shall be of the best quality.' . . . The U. S. Bureau of Standards has published some standards of quality. There are standard codes of practice for electric and gas installation. Very fine construction work has been done by the American Society for Testing Materials. These definitions have generally been of materials and have not included methods of doing work. Like standards and exact definitions should be made of every material used in construction and of every process of installation. The result would be that every contractor would know at once exactly what he was required to furnish and would not be dependent upon interpretation by any engineer and his subordinate."

As appears from its prospectus published in this journal February 16, the American Specification Institute proposes to standardize the "methods of doing work" and of "every process of installation," thus completing the work initiated by such organizations as are mentioned above by Mr. King. The demand for this particular work seems to be very general and it is by a concerted effort of *all* interests and persons affected by specifications for materials and labor, that a speedy and effective improvement in this condition will be made.

Those desiring further information concerning The American Specification Institute may secure it by addressing Gardner C. Coughlin, secretary pro tem, Room 1144, American Bond and Mortgage Building, Chicago, Illinois.

Some Examples of American Chippendale

A Remarkable Exhibition of the Work of the Early American Craftsmen in Furniture

The collection of American and English furniture, gathered by Mr. Louis Germeau Myers, some notable examples of which are illustrated in this issue, was before its dispersal by auction, one of the most notable of the work of the early craftsmen in furniture both in England and the United States.

The majority of the large number of pieces are in an original condition and but few have in any way been "restored." This fact makes these examples of our most interesting period of furniture design of first importance and affords an absolutely reliable suggestive value to the furniture craftsman in this country.

Own Your Home Competition

Through the courtesy of the Own Your Home Exposition, Inc., we are permitted to illustrate in this issue six of the premeditated designs entered in a recent competition. We are advised that these plans are to be published in book form by the Building Plan Holding Corporation of New York, of which Moore, McCarr, Gilchrist & Associates, Inc., are exclusive distributors.

In the resumption of home building, inevitable in the near future, the prospective home builder will be able to find the type of house and of the material exactly to suit his needs among the many highly meritorious designs that have been submitted. This propaganda for home building is already achieving the success it merits as a promoter of the best phases of home life, another development of a better Americanism.



AMERICAN HEPPLEWHITE MAHOGANY SIDEBOARD, FROM THE MYERS COLLECTION. PERIOD ABOUT 1795. THIS PIECE IS SAID TO REPRESENT THE HIGHEST TYPE OF AMERICAN SIDEBOARD

For Better Specifications

Further Letters from Readers with Reference to the American Specification Institute

There is, undoubtedly, a great need in the profession for better specifications, which means better specification writers. Examination of a number of specifications leads one to the same conclusion suggested in your letter, that the specifications now produced, taken as a whole, are the least creditable portion of the output of architects' offices.

Our own experience is that even after the most careful and painstaking preparation certain specifications, when tested by actual use in connection with the plans, show a number of what may be termed "loopholes," and in certain portions they fail for want of certain definite descriptions.

Unfortunately most of the defects are brought to light not during the period of estimating, but after contracts are let and work is started. At this time the weak places appear and any changes that become necessary entail additions to the contract and explanations without end.

Your "American Architect Specification Manual" is undoubtedly a step in the right direction, and we believe that the formation of a Specification Institute, together with a department in THE AMERICAN ARCHITECT devoted to specifications, would present the opportunity for a decided improvement in specifications.

FAVROT & LIVAUDAIS, LTD.

New Orleans, La.

We agree with you that there is great need in the profession for better specification writers; also that the specifications now produced, taken as a whole, are the least creditable portion of the output of the average architect's office. Any steps which can be taken toward the improvement of specifications will be well worth while.

In our own experience we developed some time ago a duplicate card file of specifications, each separate card having a typical specification paragraph, and all filed under their various headings in such a way that the specification writer, by starting through the files, would pick out the various paragraphs which applied to the work in hand and dictate such additional paragraphs or any new paragraphs which might be required for the immediate job upon which he was working.

After the use of this system for several years we have acquired a large number of typical specifications for various sorts of buildings to which our specification writer is now more apt to refer as prototypes for his specification work than to the card file system.

We are not sure that the formation of a Specification Institute would be the answer to the question or

prove an effective method of carrying on the work. Another item which enters into it is the difference in the details of the specifications in various parts of the country where we find that very radically different practices obtain, and a specification which is correct for New England may not be correct for Texas. We refer to the kinds of materials available more than to methods of using them, although even the latter are affected also.

SCIENCK & WILLIAMS.

Dayton, O.

We wish to acknowledge and to indorse your proposed carrying out of a program to produce better specifications and to assure you if there is any way in which we can help in this matter we will be glad to do so.

LOCKWOOD, GREENE & Co., Engineers.

Boston.

It is quite obvious that anything that will tend to improve the writing of architects' specifications would be very desirable, and if you can work out a plan whereby such an Institute as you suggest can be made effective, it will accomplish a very good purpose.

RANKIN, KELLOGG & CRANE.

Philadelphia.

Want Technical Man in War Department

The American Engineering Council of the Federated American Engineering Societies sent to President Harding a communication asking that an engineer be appointed Assistant Secretary of War. Another communication requested Mr. Harding to name an engineer for the vacancy on the Interstate Commerce Commission. Both communications were authorized by vote of the Executive Board of the Council, of which Herbert C. Hoover is president, and which represents 150,000 American engineers.

The appeal to Mr. Harding to select an engineer as Assistant Secretary of War says that this position of which are concerned with engineering." The organization says that the appointee should possess technical knowledge and be familiar with the cost of construction and operation. Mr. Harding was asked "to give earnest thought to the selection for the Interstate Commerce Commission of a man with the training and experience of an engineer familiar with transportation problems. The body established to regulate the commerce, the carriers and the ways of communication, embracing so many engineering features, should number among its nine members men of engineering training and experience."



AN AMERICAN HEPPLEWHITE CHINA CABINET

This cabinet is one of a pair from the Louis G. Myers collection, and was undoubtedly made in Philadelphia about 1790. It is of figured mahogany with wide bands of satinwood. The center draw encloses a desk. Height, 9 feet; width, 6 feet 1 inch. Depth at center, 13 inches; at wings, 21 inches.

What About the Personal Equation?

AT a time when every person should be considering the problem of reconstruction as a *personal* problem, we have an unlovely vista of legislative committees without number, small groups of forward-looking citizens, investigating societies and even individuals studying conditions, suggesting constructive programs, and occasionally putting into motion some sort of reconstructive activity.

That, as every thinking man knows, is not at all correct. This is not saying that there are not occasions—and plenty of them—when Government investigations become necessary, because such instances are unfortunately only too many. But it is saying that the continual shifting of responsibility has become a matter of habit with us as a nation. "Passing the buck," as slang so expressively puts it, is becoming more and more an all-year-round sport with us. We take it for granted that *someone else* will investigate, make suggestions, and produce results. We continually put it up to the other fellow.

Now, this is doubly deplorable in a republic. Nothing could possibly be more harmful to good citizenship, for good citizenship consists in *individual thought*, in the working out of the personal equation in all matters. No nation can stand whose people do not think as individuals. History has proved that time and again. The thinking group—how pitifully small it is!—can lead the unthinking crowd just so long. It is then up to the latter to put into practice what it has learned. Education presupposes that. Knowledge is not power and is not useful unless it is applied. Its application in this instance consists in nothing more difficult than daily thought.

APPLIED to the building and housing problems, this matter of the personal equation becomes more and more important.

How many persons, during the recent building trades investigation in New York, looked into even the name of the so-called "Calder Committee" was not that at all? How many would know what the Senate Committee on Reconstruction and Production was, and what it did, or is doing? How many knew of its existence? How many have the faintest idea of what constitutes "restraint of trade" and what the so-called Sherman anti-trust law really can and ought to do?

Precious few indeed.

It may be argued that all this is academic. It may be said that the daily press contributes a wealth of

information for its readers. Both assertions would be correct, and both would be wrong. Correct in that anything suggestive of constructive education and real substantiality of thought and intellectual processes is always considered academic by the majority; incorrect in that the few questions suggested above as a test of the average person's economic and political astuteness are practical questions, affecting the daily life and activities of every inhabitant of the United States. As for the daily press, there is information, and of value, but it is submerged and presented in decidedly unattractive guise. What is more, the press exists, from a financial standpoint, because it "gives" the people what they want," and if one studies the readers of daily newspapers in almost any public place and in private homes, one finds that the people seem to want the sporting pages, scandal, sensation, and the "daily comic page." So that the press would not appear to do much good with its wealth of information on the more serious side of national life.

ONE illustration and we are done. In the so-called Clayton act, passed to eliminate some of the graft in the supplying of equipment to railroads by private supply and repair companies, there was one word—"substantial"—which provided the loophole for the corporations which the act sought to check. It is not necessary to dwell upon the reason for that word. The fact remains that it is there. It is what may very properly be termed a weasel word. It works in precisely that way.

Now, any citizens of this country who was duly qualified to vote could have obtained a copy of the congressional record with that proposed act in it. He could have read it in its entirety in a very few newspapers. There were other ways of looking into that act, *before it was passed*.

Yet how many voters troubled themselves to look it up? How many would have read the act in the newspapers? Again the precious few. Yet that word "substantial" *was* substantial enough to cost the individual more to live, because he paid more for clothes and food and building materials on account of it. This is perfectly apparent to architects.

What is the matter with us? Why do we permit such loopholes in our legislation? Why is it that we so neglect the personal equation in everything, and particularly in the problem of reconstruction?

The editors would like to hear from you. Where do you think the trouble lies?



AMERICAN MAHOGANY AND GIBB MIRROR. SIGNED ON BACK BY JOHN ELLIOTT OF PHILADELPHIA, 1750.



AN AMERICAN CHIPPENDALE MAHOGANY CABINET TOP DESK. PERIOD ABOUT 1750.

TWO NOTABLE EXAMPLES FROM THE MYERS COLLECTION OF EARLY AMERICAN FURNITURE

Business Conditions

THE process of placing business upon a level fairly comparable with that which prevailed prior to 1914 is in progress, says the National Bank of Commerce in New York. This is particularly the case with regard to iron and steel, the necessary materials for practically every industry.

Retail prices and labor costs are the two problems of the day, according to this bank. Labor costs must be readjusted to new price levels in an orderly fashion with the greatest possible recognition of the social problems involved. Retail prices must be lowered. Retail prices have naturally lagged behind the downward movement of wholesale prices. Their adjustment has been further delayed, during the past few years, by a temporary speculative element which has come into the circle of distribution.

"These speculative middlemen," states the Bank, "who for the most part serve no economic purpose, have largely been eliminated by rapidly falling commodity prices, but the effect of their presence is still felt to some extent in the unduly high cost of much of the present retailers' stocks, as well as in a general lowering of the standards of commercial morality and a disregard of trade conditions."

It is significant that the Bank believes that precipitous declines in commodity prices are passed, ex-

cept in the case of iron and steel and a few other commodities where the full forces of readjustment have not yet been felt. It is pertinent to state here that, while it is difficult to conduct business at a profit in a period of sharply declining prices, there is no reason why normal business at a satisfactory profit should not be entirely possible. The Bank points most significantly to the fact that the enormous expansion in the United States during the thirty years following the Civil War was carried on in just such an era of gradually declining prices.

The following paragraph occurs in a recent summary of business conditions issued by the National Bank of Commerce:

"It is time to come absolutely to a realization that the period of semi-speculative business in staple lines has passed. Not only must the machinery of trade be readjusted to more normal price levels, but there must be a return to the mental attitude of the time when strict integrity and a broad and thorough knowledge of trade conditions were recognized as among the necessary assets of the well-established business."

It would benefit business considerably if the words "It is time to come *absolutely* to a *realization*" could be shouted from every housetop in the country.



DEPARTMENT OF ARCHITECTURAL ENGINEERING



LOADING OF PANELS H, J AND K AT THE TIME OF THE NOVEMBER TEST
Panels are lettered right to left

Tile and Concrete Floor Shows to Advantage Under Test

Bureau of Standards Investigation Produces Further Valuable Design Data

FURTHER interesting results have been obtained by the Bureau of Standards in their continuous test of concrete and hollow tile floors under different conditions of loading and reinforced in two directions. The first part of this test was published in *THE AMERICAN ARCHITECT* for August 11, 1920, and since then additional investigations have been made under a different loading. In view of the numerous inquiries we have received regarding this type of floor construction, we have deemed it advisable to present this recent information. The different stages of the test will be referred to as the February test, the April test and the November test.

It will be remembered that this test was conducted under the supervision of W. A. Slater, Engineer-Physicist of the Bureau of Standards, upon panels designed as in Fig. 1, for J. J. Whitacre, Waynesburg, Ohio.

Before the slab was first loaded in December, 1919, four posts were placed under the slab in each panel. These posts were of such a length that their upper ends came within about 3 in. of the bottom of the slab. These posts were provided in order to insure safety in case complete failure should occur with the slab under load. Up to April 22, 1920, the end of the April test, none of the panels had deflected sufficiently to cause the slab to rest upon the posts.

THE AMERICAN ARCHITECT

Within a few weeks it was noted that the slab of panel *F* had deflected while standing under full load so that it rested upon two of the posts. The other two posts were free of the slab. The posts formed the corners of a rectangle under the center of the slab about one-fourth the size of the slab. The location of the posts in the other panels was approximately the same as those in panel *F*.

After the completion of the April test the deflec-

panels *R*, *L* and *Q*. No further changes were made before the November test.

At the beginning of the November test panel *H* had an applied load of 730 lb. per sq. ft., panel *K* had 505 lb. per sq. ft. and panel *J* had a load varying from 90 to 280 lb. per sq. ft. in different parts of the panel.

The intensities of the load per square foot, stated in this report, are based upon the areas given by the

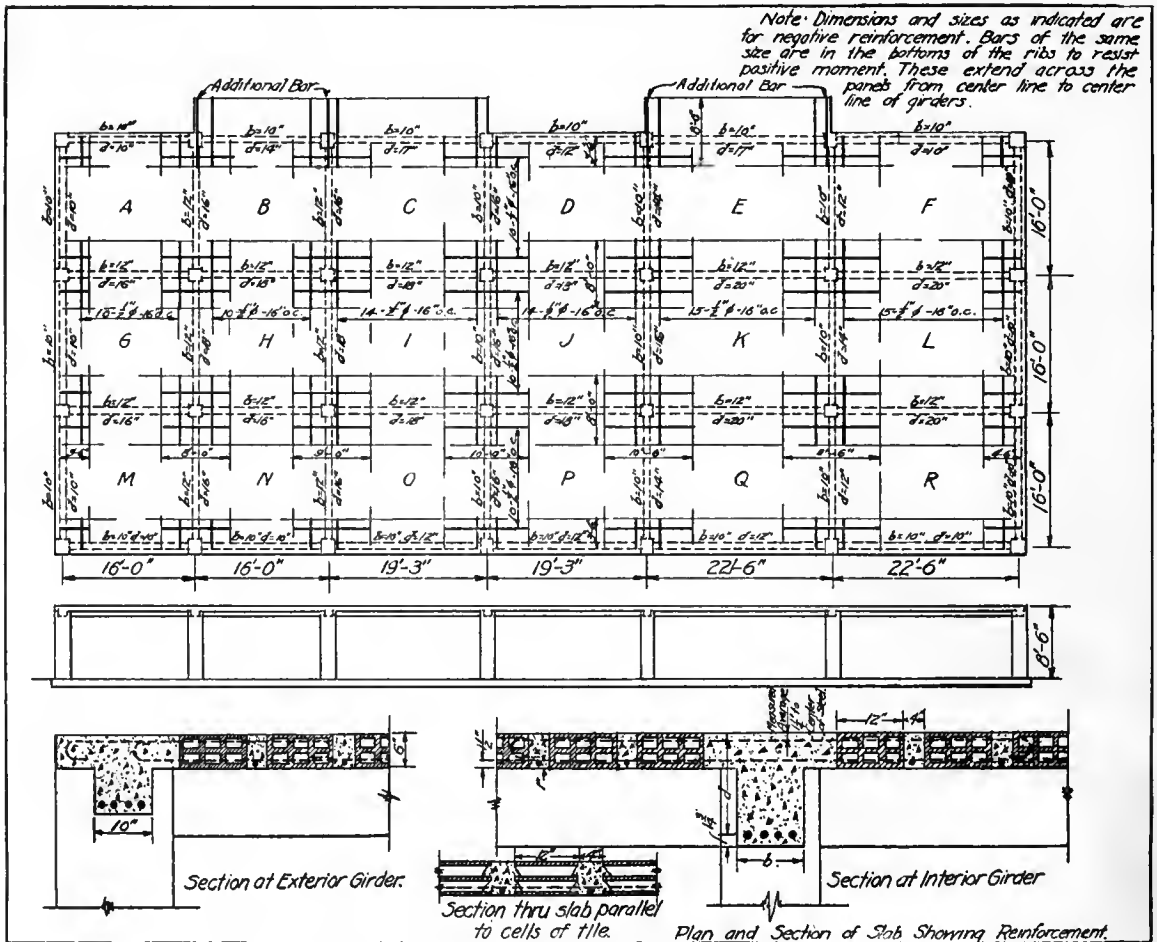

FIG. 1. PLAN OF TEST SLAB, SHOWING REINFORCEMENT

Cross sections indicate method of placing tiles

tion apparatus had been removed and the further deflection of the slab could not be determined except by measurement of the curvature of its under surface, assuming that originally it was a plain surface. By this means the deflections shown in Table I were found just previous to the November test.

Fig. 2 shows the conditions of the loading at the completion of the April test. The load remained as shown in this figure until late in the summer of 1920, when practically all the load was removed from

	TABLE I. MAXIMUM LOADS AND SUMMARY OF DEFLECTIONS.					
	Applied Load			Deflection—Inches		
	After first test (Apr., 1920)	Before second test (Nov., 1920)	After second test (b) 200	After first test (Apr., 1920)	Before second test (Nov., 1920)	After second test
Panel <i>H</i>	730	730	1413	1.72	2.6	2.02
<i>F</i>	370	370	(b) 200	.68	1.0	1.40
<i>J</i>	(a) 190	(a) 140	1184	...	0.4	2.03
<i>K</i>	505	505	920	1.32	2.3	3.00

(a) The intensity of the load varied greatly in different parts of this panel.

(b) This is a rough estimate of the equivalent uniform load upon this panel after the November test.

product of the clear spans, that is, the intensities of load are obtained by dividing the total panel load by the area within the inner faces of the supporting girders.

This method of computing the intensities of the loads is consistent with the ordinary practice in which the clear span is used for the purpose of computing moments. It was believed also to be nearly exact, and was used as the basis upon which the

the stacks. For the sake of safety and in order to secure maximum loads with the least height the stacks above the planking were made solid, that is, no aisles were provided as in the stacks below the planking. The stacks of brick were of such height before the planking was used that it was believed that the additional loads would be carried down to the slab, without arching to the edges of the panels. In spite of the precaution taken to secure maximum loads with minimum heights it was not practicable to carry the loads high enough to cause failure of the slab in any of the panels.

An effort has been made to obtain some information from the results of this test on the amount and distribution of load on the girder. Since no strain gage readings were taken dependence has to be placed upon the appearance of cracks to show when the yield point was reached.

From the size of the cracks at the center of the span of girder *J K* it seems certain that the yield-point stress of the steel reinforcement had been reached at the maximum load. On account of the great amount of deformation which could occur without appreciable increase of the stress it seems certain that the stress in the reinforcement could not have been greatly in excess of the yield-point

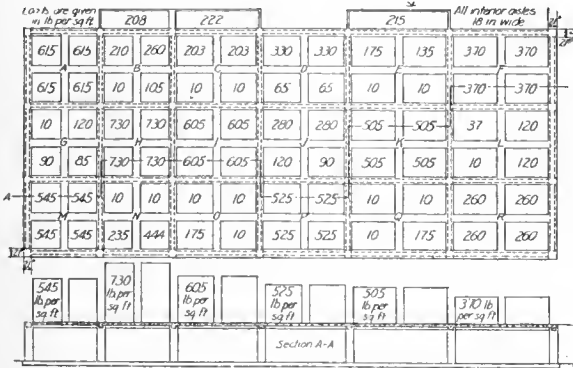

FIG. 2. DIAGRAM OF FINAL LOAD

Shifting of load commenced April 3, and was completed April 22, 1920

loads mentioned in the article which appeared in THE AMERICAN ARCHITECT, August 11, 1920, were computed. It has since been shown that the moment coefficients found by means of these loads and the measured stresses are from 8 to 10 per cent. too low. Since the intensity of the load is a nominal matter and since a large amount of work and danger of confusion would be involved in restating the loads on a different basis the previous method of computing the load is continued. However, for computing moment coefficients a load 8 per cent. smaller than that found in this way has been used. This gives almost the same results as would be obtained by basing the intensity of the load upon the total area of the panel between the center lines of the supporting girders.

While it was evident that the cracks had opened slightly between the April test and the November test they were still generally quite small and no new cracks were found. At the beginning of the November test postage stamps or other gummed paper patches were pasted across some of the more significant cracks as a means of detecting any opening of the tracks. Frequent inspection of the cracks was made during the ensuing test.

To furnish loading material for the three panels tested, bricks were taken from adjoining panels. These were laid upon platforms of 2-in. planking which had been placed upon the top of the stacks of brick already on the panels. The layer of planking was necessary in order to insure stability of



CLOSE-UP OF PANEL H UNDER LOAD

stress. Taking this stress in the reinforcement at 46,300 lb. per sq. in. (determined by tests of specimens of the girder reinforcement) the resisting moment in the girder is found to be 1,335,000 inch-pounds.

Assuming triangular loading, a loading which increases uniformly in intensity from zero at each end of the girder to a maximum at the center of the span, the computed coefficient *K* in the formula,

$$K = \frac{M}{Wl}$$

was found to be 1/16.

ment in the tops of the ribs was thoroughly anchored.

Tests which are on record indicate that with thorough end anchorage of the longitudinal reinforcement of beams which have no stirrups or bent-up bars, diagonal tension failure may be expected at a shearing stress not greater than about 250 lb. per sq. in. for concrete such as was used in this test. If this is true it seems reasonable to assume that the difference between this value of 250 lb. per sq. in. and 460 lb. per sq. in. (the shear calculated upon the concrete rib alone) must be due to assistance from the tile walls for the north-south ribs or to the concrete which ran into the tile cells in the east-west ribs.

There is more uncertainty as to the correctness of the computations for shear in the oblong panels than in the square panels, but the indications are that the shearing stresses in the ribs were lower for panels *J* and *K* than they were for panel *H*.

The deflections for the April test and the November test are given in Fig. 4. The deflection at the center of panel *H* had increased from 0.68 in. at the end of the April test to about 1.0 in. at the beginning of the November test. The deflection in panel *J* had changed very little, but that in panel *K* had increased about 1.2 in. between the April test and the November test. In view of the fact that the load on the slab during this time was about nine, or more, times as great as standard conservative design would recognize as a safe live and dead load, this increase in deflection is small. For all the panels the rate of deflection with increase of load was about the same for the high load as for the low load.

Since the deflections did not increase more rapidly in the latter part of the test than in the early part it seems that the bending stresses can not have been increasing very rapidly either. Also, the cracks did not open any more rapidly toward the end of the test than with a lower load.

These facts suggest the possibility of arch or dome action in the slab. If such action occurred it seems proper to recognize it as a source of strength in any slab in which it is reasonable to expect it to be present.

The Joint Committee recommendations for the design of slabs supported around their edges on girders would recognize the slab of panel *H* as suitable to carry a safe load (sum of live load and dead load) of 83 lb. per sq. ft. or a safe live load of 33 lb. per sq. ft. The yield point of the steel used to reinforce this slab was 54,000 lb. per sq. in. If the passing of the yield point of the reinforcement marks the failure of the slab the maximum load to be expected (based upon the Joint Committee recommendations) should be about 280 lb. per sq. ft. This

is only about one-fifth of the load carried by the slab in the November test. The safe live and dead load of 83 lb. per sq. ft. is about one-sixteenth of the load actually carried on panel *H*.

If it be assumed that the reinforcement was stressed in tension to the yield point both at the supports and at the center of the span and that the entire load was carried by flexure of the slab the moment at each of these places would be 0.00865Wl.

Computations based upon the Joint Committee standards give 67 lb. per sq. ft. as the safe live and dead load for panel *J*. The test load of 1,184 lb. per sq. ft. plus the weight of the slab minus the reduction of 8 per cent. referred to on page 329 is seventeen times the safe live and dead load.

For panel *K* the safe live and dead load, computed in a similar manner, is 48 lb. per sq. ft. and the test load of 920 lb. per sq. ft. plus the weight of the slab minus 8 per cent. of the total is more than eighteen times as great.

Taking the weight of the slab as 50 lb. per sq. ft. and the safe loads given in these computations it is found that panel *H* would safely carry only a little more than one course of brick, panel *J* would carry only two-thirds of a course and panel *K* would not be safe under its own weight.

The foregoing comparisons indicate that more liberal rulings might safely be made for the design of slabs of this type even though it may not be feasible to explain analytically the action of the slab under load.

Fire Precautions in a Woodworking Plant

All stair wells and elevator shafts should be enclosed in fireproof towers, and to make fire walls and fireproof towers effective all openings should be fitted with automatic fire doors. Stairs should be of non-combustible material so they cannot be destroyed in case fire is communicated to the stair well itself. All sash should be steel and the windows opposite adjacent buildings, where buildings are 30 ft. apart or less, should be glazed with wire glass. A good sprinkler system should be installed throughout the entire plant with plenty of yard hydrants and a good supply of fire hose. All motor-control switches should be enclosed in steel boxes so arranged that the box cannot be opened when the switch is closed. All switches for motors driving spray-booth fans, or for motors in other locations where inflammable gas or dust is prevalent, should be of the remote control type enclosed in tight steel or iron cases, with a push button near the booth or other machine.

Steel Forms for Concrete Columns and Floor Slabs

Describing the Application of Metal Forms in the Construction of the Columbia Graphophone Company's New Seven-Story Structure in Baltimore

DURING the decade before the war, steel forms attracted considerable interest in the field of concrete construction. Architects, engineers and contractors, seeking a way to avoid lumber waste and to minimize the amount of labor incidental to the use of wooden forms, gradually came to realize that the solution of their problem lay in the use of such forms. This recognition increased to a still greater extent during the past few years, when construction men found in steel forms a decided relief from the high wages and lumber prices; but today they are more widely used than ever. At the present time, when cost reduction is the watchword of business world, the economy features of steel forms promise to make them standard equipment for all concrete construction.

Steel, for forming or moulding concrete, has many advantages over wood. Forms can be re-used almost indefinitely, with no possibility of warping or wearing and, consequently, without waste. Concrete formed with steel presents a much smoother surface than can be obtained with the use of wood. The forms come to the building site ready for use, thus eliminating the field labor which must necessarily be expended to manufacture wood into forms.

On jobs involving circular construction, the use of these forms has been so successful and is so generally understood, that it has become standard practice. This class of work includes tunnels, culverts, large sewers, etc. It was not until the last two years, however, that the use of steel forms has proved economical and efficient for constructing flat slab concrete floors. A notable example is the Columbia Graphophone Building recently completed in Baltimore,

Md., by M. A. Long Company, general contractors.

The Columbia building is a seven-story structure with a floor area of approximately 8,400 sq. ft. per floor or a total of about 670,000 sq. ft., including the roof. Columns are spaced twenty feet on centers and the drop panels at the column heads are eight feet square. The floor slabs are nine inches thick and the round columns vary from forty inches in diameter in the basement to sixteen inches on the top floor. The upper six floors and the roof slab were formed and

poured in 73 working days.

The extent of the operation is shown in Fig. 1, which indicates in a general way the sequence of movement in the handling of the forms and placing of concrete.

Form work was started at both ends and moved towards the middle, with the job organization so distributed that



FIG. 1. SHOWING EXTENT OF THE OPERATION

when concreting was finished in the middle portion, forms were again ready for concreting at the two ends.

General practice has required the use of from 3.2 to 4.0 B. F. M. lumber per sq. ft. contact area of concrete formed. The method of forming employed in the construction of this building required the use of but 1.35 B. F. M. lumber per sq. ft. contact area of concrete formed and over one-half of this lumber was re-used four days after the concrete was poured. One-half of the lumber then left in place or one-fourth of the total was removed in about ten days and the balance removed in about three weeks.

The system of shoring as employed with the steel forms was such as not to require reshoring; and due to the fact that the steel forms would not permit of seepage of cement to the shoring below and the fact

that practically no nails were required, the lumber used for this purpose was remarkably clean at the completion of the job and had a high salvage value. However, the outstanding feature was the fact that it was necessary to purchase and expend or destroy less than one-fifth of the lumber that would have been destroyed if lumber alone had been used.

The shoring used was of 4" x 4" timber placed six feet on centers one way and five feet on centers in the other direction. These timbers were made up on the ground before erection work was started, cut the proper length with due allowance made for wedging at the bottom to take care of inequalities in the levels of the concrete slabs. The shores were fastened together on the floor with a 1" x 6" timber and raised in batteries of three. The 1" x 6" served as a spacer for the proper centering of the shoring posts and at the same time provided a ledger support at the proper scaffold height, to work on when erecting ledgers for carrying steel panel forms, as well as



FIG. 3. VIEW UNDER SUPPORTS

the 4" x 4" shores, the top of the 4" x 4" in direct contact with the underside of the top metal of the one foot steel panel. Next to the 1-ft. panel, two 2-ft. panels were placed and then another 1-ft. panel making the 1-ft. panels, five feet on centers in that direction of the centering of the shores.

The steel panels, after being placed, received a brush coat of light paraffine oil, after which the reinforcing steel was placed, the inserts set and the concrete poured. In connection with the setting of inserts, a small hole was drilled in the desired locations through the steel panels, a small breast drill being used for the purpose with a bit on a shank long enough so that it could be operated from a standing position, a very few turns being necessary to drill through. The inserts were then held in place by the use of a barbed four penny nail driven into the hole. This held the inserts securely and the resultant holes were so small as not to affect the appearance of concrete poured on the panels when re-used.

The system of laying steel panels was so laid out as to leave very few spaces requiring patching and these were taken care of by laying down strips of steel sheets of required width and length.



FIG. 2. SHOWING METHOD OF ERECTING SUPPORTS

providing a scaffold from which to strip ledgers and steel panels after concrete was poured. After the shoring was erected, the tops were leveled with the use of a transit, one man at the instrument, while another operated the rod which was hooked over the top of the shore. The second man also drove the wedges at the bottom of the shore, bringing the top to the proper elevation. Thus two lines of shores were leveled at one setup of the instrument. The ledgers carried by the shores were of 2" x 8"s. These were supported as shown on Figs. 2, 3 and 4. This method of supporting the stringers required the use of no nails, for a 2" x 4" slab on each side of the shore pivoted on a bolt when turned up, held the stringers in a vertical position.

The shoring system was then ready to receive the steel panels, these panels being made of No. 14 gauge pressed steel in two standard sizes, 6 ft. long by 2 ft. wide and 6 ft. long by 1 ft. wide, and so designed as to carry the maximum imposed load when supported at the ends. These panels were laid on the stringers without nailing and butted end to end and side to side, the ends of the one foot panels coming directly over



FIG. 4. VIEW FROM ABOVE

THE AMERICAN ARCHITECT

All interior columns were round with bell shaped heads. These were formed with steel forms adjustable to height and diameter. The surface of the steel coming in contact with the concrete was coated with light paraffine oil, which not only prevented the concrete from adhering to the forms, but materially affected the resultant finish on the concrete columns, leaving them with a smooth, glazed finish. The same finish was obtained on the ceilings. Fig. 6 illustrates one of the floors after forms were stripped, and gives a fair appearance of the finish obtained without patching or brushing.

After concrete slabs were poured about four days, the supporting 2" x 8" stringers were removed by turning down the 2" x 4" slabs on the sides of the shores. This operation released the 2" x 6" panels, leaving the 1" x 6" panels in place supported on the top of the shores only. It will be noted that this operation did not require the pulling of any nails. The 2" x 8" stringers were dropped to the bracing ledgers forming a scaffold platform from which the men worked when removing the steel panels. The steel panels when removed, were loaded directly on small trucks provided for the purpose, space between shoring providing aisle ways for operating these trucks. When loaded, the trucks were rolled to the side of the building and picked up with a hoist and



FIG. 5. PLACING THE STEEL PANELS

deposited on the succeeding working floor. This method of operation reduced rehandling to a minimum. The trucks were rolled on rubber-tired wheels and pushed by one man to the new location of panel laying as shown on Fig. 4, the car being moved forward as the panels were laid, and the panels unloaded and laid in the new position in one operation. The laying of these panels was purely a mechanical operation. A gang of seven men laid an average of 12,000 sq. ft. per day.

The concrete columns and ceilings were painted; and it may be interesting to note that, due to the

glazed finish obtained by the use of steel forms, it was necessary to use but one-half of the quantity of paint originally estimated.

In the application of the system of forming used on this operation, it was necessary to make some slight changes in the panel layouts and sizes of de-



FIG. 6. APPEARANCE OF THE FLOOR AFTER FORMS WERE STRIPPED

pressed heads as originally shown on the architectural drawings, in order to make the entire floor plan standardized. These changes did not affect the strength of the structure nor did they add any concrete over the original plan. The saving of time and labor by virtue of this standardization was so material as to make the changes only incidental. Such changes can generally be made in adapting almost any flat slab structure to the use of steel forms in construction.

Throughout the entire job, the steel forms proved themselves adaptable to every requirement. Their superiority to wooden forms, from every standpoint, was so emphatic as to leave no room for doubt that the use of wooden forms will soon be a thing of the past and that maximum efficiency and economy in concrete construction are to be had only by means of steel forms.

Emergency Generator Units

In many plants it is often economical and convenient to install a small direct-connected high-speed generating unit to furnish lights at night and operate a few machines without the necessity of operating the main engine. As the exhaust steam from such a unit will generally be all used in the heating system and dry kilns, the power generated is practically a by-product and the only cost for the power generated is the fixed charge incident to the additional investment. Such fixed charges will often be found to be less than the cost of breakdown service from the power company.

Philadelphia's Exhibit

Plans Rapidly Maturing for Architectural Show Starting March 28

The joint exhibition board of the Philadelphia chapter of the American Institute of Architects and the T-Square Club has sent out its preliminary notice to the large list of architects on the special architectural exhibition which will be held in conjunction with the real estate and building exposition of the Philadelphia Real Estate Board, at the First Regiment Armory, during the week of March 28. The joint board of architects consists of George Howe, chairman; R. J. Wadsworth, William C. Stanton, II, Bartol Register, Donald M. Kirkpatrick, Joseph P. Sims and Clarence C. Zantinger.

In their notice the joint exhibition board said:

"An architectural exhibition is to be held in conjunction with the real estate and building exposition, beginning March 28, 1921. The purpose of the exhibition is educational, and as it marks a new departure, the hearty co-operation of all architects is urged.

"Some forty thousand visitors attended the real estate and building exposition last year, and this year an even larger attendance is anticipated. Acting in accordance with the wishes of the executive committee of the Philadelphia chapter of the American Institute of Architects and of the T-Square Club, the exhibition board is availing itself of the great educational opportunity of pre-enting before so large a public the best and most representative work done in and about Philadelphia for the last ten or fifteen years, or contemplated in the near future, laying emphasis on civic improvements and domestic architecture, particularly the small house. Such an exhibition cannot fail to have a marked influence on public taste, and all architects are again urged to co-operate by sending their best work, whether previously exhibited or not.

"Exhibits should consist of plans, drawings and models of contemplated or executed work, or of large photographs of completed buildings, and must be suitably mounted or framed. Small photographs, mounted either singly or in groups, will not be hung. Exhibits will be called for and returned by the exhibition board."

The plans of the architects' committee provide for the largest and most varied exhibition which they have ever held.

A notable exhibition of interior decorations is also being arranged by the advisory committee of architects, consisting of Nicola D'Ascenzo, Edward A. Crane, John P. B. Sinkler, Grant M. Simon, D. Knickerbacker Boyd and Emile G. Perrot.

This committee is assembling from hundreds of sources in Philadelphia furniture, draperies, objects

of art and other decorations, which, in itself, will comprise an exhibit unique in the art history of Philadelphia. Scores of the most noted antiques in this territory have been promised to the committee by their owners.

Boston Society of Architects Meets

Passes Resolution Upon Striking Mechanics

The Boston Society of Architects at a meeting held February 14, 1921, approved the following statement and passed the following resolution in regard to the present strike of the mechanics in the building trades in Boston:

"At this time employees in the building trades in Boston are on strike for higher wages and a five-day week, at a time when the cost of living is appreciably going down and there is a vital necessity for increased production. No more unfortunate time could have been taken for demanding higher wages. If there was to be any change at all it should have been in the direction of lower wages. Still more unfortunate was the demand for the Saturday holiday. If there is one thing needed in the world today it is work, and no man or woman needs two whole days of rest in seven; on the contrary, they are much better occupied six out of seven days at their normal work. This is particularly true when the normal day is on the reasonable basis of eight hours. The well-being of this Nation depends on the continued application to industry and increased production by all classes. This post-war period calls particularly for special effort on the part of all to make up for the actual, if not apparent, impoverishment of the Nation due to the wastage of war."

Voted:

WHEREAS, the prosperity of this country and of the world is now endangered by the after-effects of the War, and

WHEREAS, each individual man and woman and every group and class of men and women can help to restore pre-war conditions and prosperity by work to the end of increased production, therefore

BE IT RESOLVED, that the Boston Society of Architects makes public its opinion that the present strike of the mechanics of the building industry in Boston has been called at a most unfortunate time, and constitutes an act contrary to the public welfare, because it is based on a demand for shorter hours per week and for wartime wages.

Seattle A. I. A. Elects

The following officers were elected at the annual meeting of the American Institute of Architects (Seattle, Wash., Chapter): President, Charles Allen; first vice-president, David J. Myers; second vice-president, A. J. Russel, Tacoma, Wash.; third

THE AMERICAN ARCHITECT

vice-president, H. C. Whitehouse, Spokane, Wash.; secretary, Harold C. Smith; treasurer, Carl Siebrand and J. S. Cole, member of the board of trustees, all of whom are from Seattle, with the exception of those otherwise designated.

Guests of honor at the meeting included Henry H. Kandall, Boston, Mass.; president of the national organization, and Robert D. Kohn, a director of New York. A delegation from the Oregon Chapter assisted in the social features.

New York State Association Meets

The New York State Association of Architects held its annual meeting in Albany on February 28. Dr. Downing, head of the Professional Examinations Division, State Department of Education, spoke on the architects' registration law and the proposed amendment thereto and on other professional laws. Mr. Cawley, attorney for the Legislative Committee of the Association, talked on legal phases of the profession.

Officers for the year were elected. Leon Stern of Rochester was chosen president.

The members attended a dinner at the Albany Club and visited the Senate and Assembly.

Particular attention was given to the proposed amendments to the registration law now in force in the State. It is proposed to secure "an annual registration upon the payment of two dollars per year and to vest the power of enforcement in the person of the Attorney General." The amendments would also remove the present requirement that architects file their certificates of registration in every county where they may have work.

A letter has been sent by the Association to all members urging them to urge the passage of Bill number 904 in the Assembly and Bill number 637 in the Senate, designed to "Amend the General Business Law, In Relation to Registered Architects. The bill was introduced in the Assembly by Assemblyman Bly of the Judiciary Committee, an architect for Kings County, and has been approved by Assemblyman Martin, Chairman of the Committee. Senator Burlingame introduced it in the Senate.

The bill will probably come up for final consideration in the week of March 14, and all members of the Association, as well as other practising architects interested in it, are urged to do whatever they can to secure its passage.

Architect Wins Prize for Writing Best Play

Boston Man Gets \$500 Morosco Prize in Competition at Harvard

The annual competition at Harvard for the Morosco prize, offered by Oliver Morosco, theatrical

producer, for the best play written by a past or present member of "English 47," Prof. George P. Baker's course in play writing at Harvard and Radcliffe, has been won by Thomas P. Robinson, a practicing architect, of Boston.

The play, which wins the \$500 prize and will shortly be produced by Mr. Morosco, according to the terms of the contest, is entitled "The Copy."

Mr. Robinson, its author, is a member of the architectural firm of Derby & Robinson. He took the course of Harvard in 1912-13, and during the past few years has been intimately associated with the "47 Workshop," the dramatic laboratory at Harvard, acting as artistic adviser. He and Henry Hunt Clark of the Boston Art Museum have supervised the setting and design of plays produced by the Workshop. The judges were Prof. George P. Baker, Mr. Morosco, and Walter Prichard Eaton, the dramatic critic and author.

It is said that in all probability at least two other plays submitted in the competition will be accepted for production.

Marriage Profitable in Berlin

New Couples Secure Housing Preference

The shortage of houses and the high cost of living are no longer considered serious obstacles by the youth of Vienna and Berlin who are contemplating matrimonial ventures. A newly acquired bride is a valuable asset, as all persons recently married have been placed on the preferred list in the Government housing bureau. Moreover, one investigator says two can live in one house cheaper than one in a hotel, so that marriage has become a sound business proposition, especially if the prospective wife has a profession and can contribute to the family income. In keeping with the idea of making the undertaking a paying proposition, expensive honeymoons are now out of the question. There were 1,300 marriages in Vienna on Sunday of last week, which was the height of the carnival season, and 53,000 in Berlin during the last year, which breaks all records in the two cities.

Chicago Notes of Interest

Chicagoans count that day lost whose low descending sun sees no new plans for the preservation of the old Field museum building in Jackson Park. The Illinois Chapter of the American Institute of Architects is now planning to make it an art and recreation center and to this end an effort is being made to raise \$1,640,000, the sum necessary to place the building in repair.

Architects of Chicago and Illinois, members of various architectural organizations will co-operate in

THE AMERICAN ARCHITECT

the thirty-fourth annual exhibition of architecture to be held at the Chicago Art Institute from March 8 to April 5. Organizations co-operating in the exhibition will be the Illinois chapter of the American Institute of Architects, the Illinois Society of Architects, the Chicago Architectural Club and others. John A. Holabird is chairman of the exhibition committee.

Cambridge Architect Wins

City Planning Commission of Cleveland Awards \$500 to Philip W. Foster for Suggested Use of an Abandoned Cemetery

The City Planning Commission of Cleveland, Ohio, has just announced the award of a cash prize of \$500 for the best suggested use of an abandoned cemetery in the downtown section of Cleveland, to Philip W. Foster, landscape architect in Cambridge, associate of John Nolen, city planner. The plan of Frank J. Mulvihill, of the same office, received honorable mention. There were 206 competitors.

The features of the winning design are the extension of Carnegie avenue along Summer avenue cutting through the cemetery to meet Eagle avenue at East Ninth street so that the greatest economy in use of land is effected; the location of a tall shaft at the intersection of the axis of Carnegie and Eagle avenues if extended into the property; and the development of the rest of the cemetery into a breathing space or "in-town" park. There is provision for a children's playground in one section.

Whale Bones for Buildings

Huge Ribs Make Support for Bungalow in Cataline Islands

The scarcity of building material is not worrying Avalon, Cal., residents. For twenty years several huge whale ribs have been bleaching in the sun in front of the Avalon Tuna Club. An enterprising contractor sought the owner of the historic bones. He didn't want them for a museum, but they would make the supports for a "whale of a bungalowette," he explained.

Canvass, wallboard and flooring have been added to the bones and the popular little Catalina island city has acquired a new shelter for its many visitors.

White House Again to Become Mecca Under the Hardings

In an effort again to make the White House and grounds one of America's show places, to which pilgrimages may be made by people from all parts of the country, plans are being made, under the supervision of Col. Clarence Ridley, superintendent of buildings and grounds, to beautify the property by

the addition of thousands of flowers and expansive shrubs.

The White House grounds were closed to the public with the entrance of the United States into the war, and since the signing of the armistice two years ago President Wilson, desiring to continue his seclusion from the public, has maintained the ban against visitors.

Under the Harding administration it is expected that the White House grounds will be more accessible to the public and that no protests will be made against visitors being conducted through the historic rooms of the executive mansion.

America's Gift to the World

Will It Be of an Artistic or Ethical Nature, Asks St. John Ervine

It may be, as Meredith Nicholson has suggested, that America's gift to the world will not be an artistic gift at all, but an ethical one.

Each country seems, like each person, to have some peculiar gift to give to humanity. England gives poetry to the world—there has never been in any other country such a procession of poets as have passed through England in the last six hundred years—and Germany gives great music to it. What is the gift that America will give? I am interested in Meredith Nicholson's opinion that the gift may be a higher standard of justice, a greater range of freedom, though contemporary life in the United States hardly convinces me that his opinion is sound.

In any event, America must produce a literature of her own. If her gift to the world is to be a nobler ethics than the world now possesses, then she cannot fail also to give the world a noble literature. All great writing is fundamentally the expression of a powerful individuality. One expects to find the greatest literature in that country where individuality has the freest play. Is that country America?

Treasures of Loreto Are Reduced to Ashes

Relics of Holy Family Burned

Pope Benedict has received a report from Mgr. Andreoli, Archbishop of Loreto, showing the losses of irreplaceable religious treasures in the fire in the Chiesa della Cassa Santo in Loreto to have been more calamitous than at first reported. The loss through the burning of the church which sheltered the world-famous shrine, according to Catholic tradition the early home of Christ in Nazareth, is estimated at more than 12,000,000 gold lire.

The shrine, which was decorated with arabesques in gilded brass, and the priceless statue of the Virgin were reduced to ashes. No trace of the precious

cedar wood of which the statue was made was left.

Other artistic and religious treasures destroyed included the altar, decorated with semi-precious stones, and a sacred dish, supposed to have belonged to the Holy Family, which was lined with gold worked by Benvenuto Cellini. Two silver busts representing St. Anne and St. Joseph, the silver bells on both sides of the statue of the Virgin, and all the votive lamps of gold and silver were completely melted.

Profound sorrow is felt by the peasants living in the Loreto district as a result of the loss of the famous Madonna and her altar.

Illinois Chapter Architects Hold Meeting

Interesting Subjects at Monthly Meeting of Illinois Chapter of American Institute of Architects

A very full and interesting program was presented to the members of the American Institute of Architects, Illinois Chapter, during its recent meeting at the Art Institute. Following the dinner, Mr. Henry K. Holsman, president of the chapter and the presiding officer, presented several gentlemen who have been nominated by the various architectural journals to judge the best plans in the small house competition.

Among those appointed was Mr. E. J. Russell, of St. Louis Chapter, of the American Institute of Architects, who spoke briefly concerning the National Board of Jurisdictional Awards. Mr. Russell predicted a stirring session of the Board in March. The cause of the storm, he said, would be the President of the International Brotherhood of Carpenters, who will stand pat for the unions.

Mr. H. W. Hewitt, of the Minneapolis chapter, of the American Institute of Architects, stated that very few architects can afford to handle small house plans of five or six rooms. He said the Minnesota Small House Bureau has designed about one hundred different houses from four to six rooms. The Bureau favors using as much standardized material, such as form lumber, etc., as possible. Mr. Hewitt is also on the board of judges.

Mr. Dwight H. Baum, of the New York Chapter, of the American Institute of Architects, another member of the board of judges, sketched briefly the exhibit New York will have on March 26, for which about \$30,000 has been appropriated to date to cover expenses.

Mr. Hal. H. Hense, from the Atlanta (Ga.) Chapter, of the American Institute of Architects, was introduced by Mr. Holsman, who asked him to tell the architects "how you all do it down there."

Mr. Robert H. Sexton, who is manager of the "Own Your Home" exhibition in Chicago, to be held on March 26 to April 2, said: "To build bet-

ter homes—that is what the exposition stands for."

Mr. Henry G. Zander, of Koester & Zander, Chicago, spoke short and to the point. He commended the action of the Institute in endorsing the Calder bill providing for a federal bureau devoted to the construction industry in Washington. Mr. Zander declared that the bankers of Chicago believe that an adequate fund will be available for home building as soon as building costs are stabilized. The speaker said a loan of \$5,000 may be secured at the present time and that the larger operations will be financed in the future. Mr. Zander cited a case wherein \$3,000,000 was to be loaned on a large building project at six per cent., but was offered at seven per cent. He warned the assembled architects that the individual municipalities would float bond issues in all parts of the country to finance housing, thus coming in competition with the mortgage loan bankers and others, if money could not be secured through the banks.

Professor James H. Breasted, of the University of Chicago, was the lecturer of the evening, his subject being, "Architectural Origin in the Ancient Orient." With the use of slides he showed how the pyramids of the ancient Pharaohs, constructed about 3,000 B. C., are the architect's heritage, being the first examples of stone masonry.

Mr. John Holabird, of the firm of Holabird and Roche, gave a brief illustrated description of the new Stadium on Chicago's lake front.

Personals

John P. Kingston & Son, architects and engineers, who were located at 518 Main street, Worcester, Mass., and later had temporary offices at 58 Front street, that city, are now in a permanent location at 507 Main street.

O. C. S. Tiroli, architect, recently opened an office at 211 State street, Bridgeport, Conn., and desires catalogs. He was formerly practicing in Worcester, Mass.

Stanley Matthews, architect, has opened an office at 75 Blymyer Bldg., Cincinnati, O.

J. E. Fieldstein, architect, formerly located at 1328 Chestnut street, Philadelphia, Pa., is now practicing at the Northwest corner Ninth and Walnut streets, that city.

George Henry Dieringer, architect and structural engineer, Wheeling, W. Va., announces that he is desirous of circulars, catalogs and prices of both bank and hospital equipment and building materials usually used in work for bank and hospital purposes.

Weekly Review of the Construction Field

With Reports of Special Correspondents in Regional Centers

"Including a Drop in Rents"

For the first time in recent history, at least, a prominent business man not directly associated with housing in any of its many phases has had something to say about rents.

The man was S. M. Felton, President of the Great Western Railroad, and this is what he said:

"The release of railroad funds by the government should act as a general tonic for business. The opinion of the leaders at the executives' (railroad) conference was that it was absolutely impossible to reduce rates soon unless wages are also cut down."

We had heard that said before, and were preparing to discard Mr. Felton's remarks, when, lo and behold, we read the following:

"There will be no business resumption in general until the readjustment is over, including a drop in rents."

For once in its life the rent problem has actually been recognized by a railroad executive, and has been spoken of almost in the same breath with a reduction in wages!

An Old Idea and a Good One

Why Not Utilize the Millions Deposited in the Postal Savings System as a Source of Building Capital?

This scheme has been proposed before, but a good thing will bear repeating.

The money mon deposited in the Postal Savings System bears simple interest at the rate of 2 per cent. That money could be loaned out to private loaning institutions at 4 per cent., and they in turn could lend it at the customary 6 per cent.

The 2 per cent. profit for the Postal Savings System would cover a substantial portion of any added clerical expense to the Government. It has been frequently shown by experts that very little added clerical expense would be involved. The loaning institutions would thus be able to get money cheaply, make a profit on it, and be assured of a supply of money from a solid source.

Add to this a change in the law so that \$5,000 and not \$2,500 would limit the individual deposit, and millions more would be made available for building purposes.

It may be argued that the private loaning institutions have plenty of money at hand, and will be able to take care of the financial side of building when Spring arrives; but it is not bad economics to assure private institutions an added supply of money, thus giving credit both flexibility and a somewhat fuller measure of stability.

Tax exempt mortgages up to \$40,000, under national and not local law, coupled with the scheme sketched above, appears to be a sound and constructive piece of proposed legislation.

How Much Have They Increased?

Just what have been the per cent. increases in labor and materials in the building industry during the period 1914-1920?

Gerhardt F. Meyne, a prominent Chicago contractor, gave the following figures at the conference recently called by the National Lumber Manufacturers' Association in Chicago:

	Increase per cent. from 1914 to 1920
Trade	
Carpenters	92
Bricklayers	67
Laborers	150
Cement finishers	92
Caisson diggers	117
Hoisting engineers	67
Structural ironworkers	84
Plasterers	67
Material	
Structural steel	206
Common brick	129
Crushed stone	157
Screenings	240
Bank sand	240
Torpedo sand	157
Portland cement	276
Lime	131
Common nails	170
Scaffold plank	129

Mr. Meyne, comparing 1914 and 1920, finds that the grand percentage of increase for labor over 1914 is 92, and for materials, 184.

That European Situation

An architect recently asked the writer if he did not consider this journal's reference to the European situation in these columns a trifle far-fetched in its application to the immediate problems of the United States. He added that he realized fully that Europe's stability would naturally be a factor in our industrial situation, but that he considered any stressed reference to it just a trifle far-fetched.

The best answer to his remarks is found in a statement recently made by Francis H. Sisson, vice-presi-

THE AMERICAN ARCHITECT

dent of the Guaranty Trust Company of New York, one of America's ablest bankers, and an official of what may be termed one of the ten most important banking institutions of the world.

Mr. Sisson said this:

"Not the least important factor which helps to gauge the money market, and financial and industrial conditions in general, is the distressing situations found in various European countries. When, for instance, the question of German reparations is settled to the satisfaction of all concerned, foreign production and manufacturing are resumed in more normal quantities, and peace is made certain once more, we will find the financial picture greatly changed for the better. All these things have a bearing upon the adjusting of prices, money rates and so forth in this country."

Gilmore—Chicago

(Special Correspondence to THE AMERICAN ARCHITECT)

CHICAGO—It all depends upon the optimism or the pessimism of the individual as to the viewpoint he now takes of the building situation in Chicago. There are straws at which both may grasp to maintain their respective attitudes. In fact, it is pretty well a toss-up as to which would have the better of the argument if the whole situation could be summed up according to the rules of debate and discussed from the premise: "Resolved that the building situation in Chicago is shortly to improve."

It may be interesting to set down a few of the points, both for and against the proposition of building and in order to save the best for the last, some of the pessimistic things shall have the first recital. Here they are in the order of their importance: Building costs not yet deflated. Labor still too high for profitable building. Money very scarce and obtainable only at ruinous rates. General business and industrial uncertainty. A dark and dire conspiracy between real estate men and apartment owners to keep up rents.

Some of these objections to the possibility of early improvement have some basis in fact. Others, of course, such as the last named, are without foundation though all of them are being quoted in the discussions upon Chicago's principal topic of conversation—the building shortage.

Perhaps, the most essential obstacles in the list above are the items of building materials, labor costs and financial stringency. The feeling is somewhat general that building materials have not yet been fully deflated. This objection applies particularly to the building materials, other than lumber, although there have been repeated protestations from material manufacturers that the process of liquidation has been fully realized.

The labor cost is undoubtedly having its weight in

the building tie-up, but the optimist can here point to a turn of the tide in his favor for that very question is now up and with fairly good chances for some revision in the wage schedules in the building trades.

As far as the financial stringency is concerned, it undoubtedly exists, though bankers are now inclined to look with greater favor upon loans for building requirements. The other items raised by the pessimists in the building complex are more or less without foundation.

On the happy other hand there are great many things to encourage the belief that building is apt to show early signs of revival. Among these optimistic indications are such things as a considerable improvement in the building permit reports, greater activity in suburban real estate, heavy inquiry as to building costs and most of all an endless agitation against high rates and a consequent discussion of the desirability of home building.

March is continuing the good record shown in February in the matter of building permits. It now looks as if the March totals would run well ahead of last March. The activity continues to be in homes and in apartment buildings and much of the homebuilding in the Chicago suburbs are not included in the city permits.

Activity is being constantly reported in the better suburbs around Chicago. Glen Ellyn reports twenty new bungalows in course of construction and now Wilmette, a northern suburb of importance, is also having its small neighborhood building boom. Other suburbs are already following suit in somewhat lesser volume.

Inquiry as to the feasibility of home-building is being made on every hand. Architects are figuring on countless residential jobs and contractors report much inquiry of this kind. The Own Your Home Exposition which is scheduled for the closing days of March and the opening days of April will unquestionably augment the volume of home-building enthusiasts and some tangible swelling of the building volume can reasonably be expected.

Repeated strife between flat-dwellers and landlords is keeping the subject constantly before the public mind and no one is being permitted to forget that there is an acute shortage of homes in Chicago and that something must be done about it.

An even more bullish factor in the situation is the knowledge that a great many important projects, including two \$3,000,000 bank buildings in the Loop district, are hanging fire merely awaiting a clarification of the general situation and settling of labor and construction costs.

A definite step toward lower building labor has been taken this week in a formal demand on the part of the Associated Builders on the carpenter's union for a lower wage scale. The proposal is to clip 25

THE AMERICAN ARCHITECT

cents an hour from the pay of carpenters and 30 cents an hour from the envelope of the ordinary laborer in the building trades. This would bring the scale down to \$1.00 and 70 cents per hour respectively. The union leaders have refused to concede anything, but in view of the fact that some 45,000 carpenters are idle or have gone into other lines at lower wages, gives the union men a rather bad advantage in discussing the situation.

Another interesting thing that will doubtless have its effect on construction costs is the announcement from the Illinois road building officials that all bids for highway construction in Illinois have been rejected on account of extreme quotations. This action is already having a bearish sag on those materials which enter into the construction of both buildings and highways, such as concrete, sand, brick, lime and the like and a consequent weakening in the materials list is not unexpected by those conversant with the economic trend of things.

If costs of construction will only adjust themselves slightly there is a great deal of important building to be done immediately within the Loop district.

One of the first big items of construction to go ahead will be the Illinois Merchants Trust Company bank building which is to face the new Federal Reserve Bank now under construction in La Salle street at Jackson Boulevard. This building will not be constructed on the cost plus basis and while the money for the construction is ready and waiting lower construction costs—notably labor costs—will have to be adjusted before the word is given to begin operations.

The State Bank of Chicago is another strong financial institution which is ready to erect, a legal-height-limit bank and office building at La Salle and Monroe streets, but which is being held back by the feeling that prices have not yet touched bottom. Both of these banks have four years under their leases and will not proceed hurriedly in the construction work.

Another large building now being discussed is a million dollar labor temple to be located at Ashland Boulevard and Adams street. The building is to be the home of the Amalgamated Clothing Workers of America, an organization having a Chicago membership of 42,000.

As far as the prices of lumber and other building materials are concerned there is very little movement. Lacking more than a nominal demand at present, prices are doing well to hold at old levels. Present quotations in the Chicago market are:

Yellow Pine: B. & B. 1-in., \$95 to \$130, depending on thickness; 2 x 4, No. 1, 10 to 16 ft. length, \$51 to \$53; 2 x 6, \$48; 2 x 8, \$50; 2 x 10, \$53; 2 x 12, \$55; 13-16 x 3¼ z & b flat flooring, \$85 to \$90; 1 x 6, No. 2 common, \$48 to \$90. *Douglas Fir:* 2 4 S, in sizes up to 12 x 12, in length up to

32 ft., \$65 to \$70; 14 x 14, \$68 to \$73; 16 x 16, \$72 to \$75; 18 x 18, \$75 to \$80. *Hard Maple:* Four, ¼ No. 1 and 2, \$135; select, \$120; No. 1 common, \$100; No. 2 common, \$65; No. 3 common, \$32. *Birch:* Four ¼ No. 1 and 2, \$160; select, \$133 to \$138; No. 1 common, \$95 to \$100; No. 2 common, \$60 to \$65; No. 3 common, \$40. *Red Gum:* Four ¼ No. 1 and 2, \$150; No. 1 common, \$90 to \$92; No. 2 common, \$45.

Face Brick—Standard, vitrified red, \$32.00@34.00; Smooth, Indiana red, \$38.00@40; Smooth, Ohio red, \$38.00@40.00; Smooth, Pennsylvania red, \$46.00@48.00; Smooth, buff, \$45.00@47.00; Smooth, gray, \$47.00@49.00; Rough, buff, \$44.00@46.00; Rough, gray, \$47.00@49.00; Variegated, rough texture, \$34.00@49.00.

Common brick, \$13.00 to \$16.00 per M. Portland cement, \$2.25 per bbl. Torpedo—Lake and bank sand, \$3.50 per yd. Crushed stone, gravel screenings, \$3.50 per yd. Hydrated lime, Ohio, paper, \$21.00 per ton. Hydrated lime, Ohio, cloth, \$29.00 per ton. (Includes sacks at 30c each). Hydrated lime, Wis. paper, \$19.00 per ton. Bulk lime, \$1.65 per ton.

(Special Correspondence to THE AMERICAN ARCHITECT)

SEATTLE—The jobbing trade of the Pacific coast is now comfortably equipped to handle any reasonable spring building demand for sheet metals, pipe, cement and roofing through augmentation of stocks during the past week. The fir lumber market is steady. Sheets are fluctuating because of offers of stock by outside mills that was rolled a year ago at lower prices. Jobbers express the opinion that the market on sheet metals, however, is inclined to be statistically sound.

Independent mills have offered this week a lot of galvanized sheets at \$5.20 base. Very little black stock is available. Black sheets rolled last year are being quoted to Pacific coast jobbers at \$3.75 and blue annealed sheets at 3 cents base. Under these conditions the corporation price is over that now being issued by the independents. The Corporation is reluctant to permit cancellations of delayed orders, some of which are now six months to a year old. No more sheets will come by water, and jobbers have issued strict orders against any more loadings to move intercoastal on account of the expense of reconditioning, which must be done by hand, thereby wiping out the parity under the rail rate.

Stocks of galvanized pipe are about normal. Inventories of 1920 show that stocks of pipe and sheets, with the exception of a few sizes, were larger here on January 1, 1921, than for any similar date in three years. Price reductions in pipe that have been in vogue fractionally for the past ten days have now ceased and buying from eastern mills has ceased abruptly. Efforts are being made to cancel some or-

ders, but it is doubtful whether the mills will permit it. Cancellations have been requested by coast jobbers in pipe fittings and valves on orders that have been accumulating for two years back.

The fir lumber market has held steady, with reduction in the volume of attacks on common dimension, which seemed to buyers to be the weakest spot in the building assortments. Average prices at which fir lumber sold at the mills for the week were \$11.50 for common dimension, \$49 for vertical grain flooring and \$20 for slash grain, \$46 for finish, which leads in strength all the building sizes, \$19 to \$25 for five-eighths by four and \$18 to \$26 for one by four ceiling, \$23 for drop siding, \$12.50 for boards and ship-lap, \$16.50 for plank and small timbers and \$21 for big timbers. Shingles are steady, with mill capacity at 40 per cent. The fir log market is weak, but there is little cutting.

The future of the fir lumber industry pivots on rates both by rail and water. The lumber shippers will make an effort before the intercoastal ship conference at San Francisco to induce a cut from \$20 per 1,000 feet to New York on the grounds that the eastern lumber demand will not respond to present rail rates and that round \$15 will meet the emergency by water. The railways have assented to only partial relief. Lumbermen are trying to make the land carriers see that they are only delaying construction over the United States by holding rates high.

Contractors of the Pacific Northwest, advocating a 20 per cent. reduction in wages for the building trades craftsmen this year at the annual convention of the Northwest Master Builders' Association at Spokane, Wash., this week ruled out the minority that was satisfied to demand a 12½ per cent. cut. This organization lost its identity when contractors of Spokane, Portland, Idaho and Montana voted to join the Associated General Contractors of the Northwest. Contractors of Seattle, Tacoma and Yakima, Wash., refused to affiliate with the national body and voted to form a state organization of master builders.

Resolutions demanded of state officials reasons why payment on estimates on state construction is held back for as long as seven months. The demand is to be made and investigation conducted by the American Society of Associated Engineers. A. J. Welton of Portland, Ore., was made chairman of the committee.

Work of demolishing the four-story Boston block in Seattle has been begun as a preliminary to the con-

struction of the new home of the National City Bank, the second of three of the city's strongest financial institutions to build modern new homes. The new bank building is to be fireproof, marble faced and particularly designed as a banking building. It will be three stories in height with basement and mezzanine, and dimensions of 120 by 108. The exterior will be a light pink gray marble, with flat marble pilasters between large windows. There are to be no columns in the public lobby.

Increase in Steel Production

THE steel market of the future will not depend upon what is done now in prices. The uppermost question of the moment is costs. Transportation charges and mill labor costs are the largest of these.

Opinion varies as to the duration of the slowness. Some expect nearly full operations by spring. Others do not look for it until late in summer. Eight of the largest independent plants of Pittsburgh have increased operations, as well as many small ones.

A small increase is noted in the amount of business done in finished lines. Prices of sheet are cut by some of the independent makers about \$1 a ton. Automobile concerns, the Standard Oil Company and other demand is calling for an increase in production. The America Sheet and Tin Plate Company's new business is somewhat below normal of the last few years at this time, but new orders steadily are gaining. The American Steel and Wire Company is maintaining a high rate at its plants in the Pittsburgh district, but is stocking a large part of its current production.

For structural shapes and plates, conditions have changed little. All makers of plates are asking the \$2.65 price, but persistent reports are heard of \$2.50 and less. The Navy Department has bids on some 3,000 tons, which are expected to uncover the real competitive price. In fabricated steel there is apparently an increase in plans for building, encouraged by nation-wide increase in rents.

Elmira, N. Y., was in the market for 200 tons of steel arches for re-inforced concrete bridge; the Massachusetts Park Commission is getting bids on 500 tons of steel for a bridge over the Neponsit river, and the Reynolds Building Trust of Boston is asking estimates on a building requiring 300 tons of steel. The League Island Navy Yard wants 3,000 tons of boat shapes.

Printed piece to No. 52561

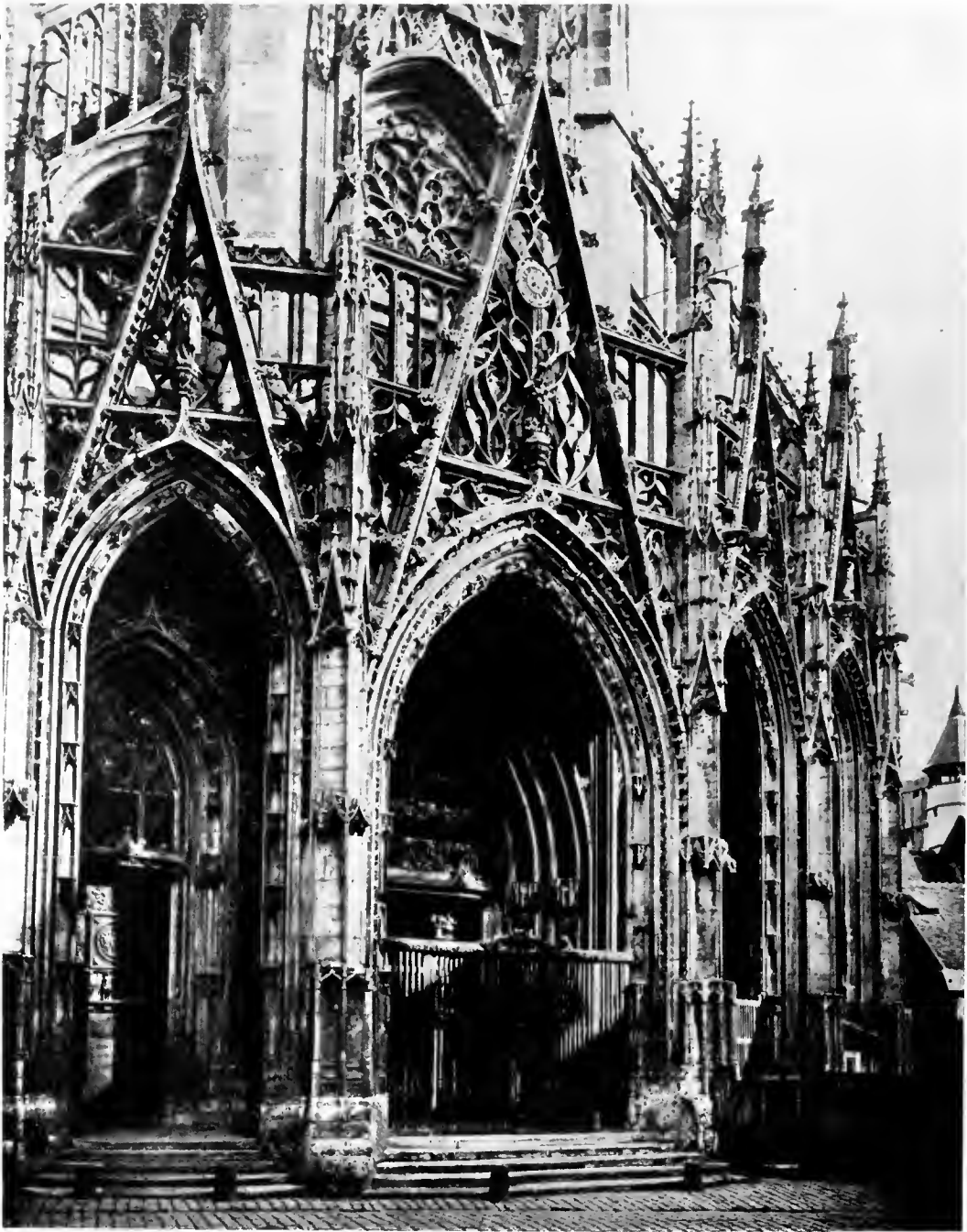

DETAIL, CHURCH OF ST. MACLOU, ROUEN, FRANCE

THE AMERICAN ARCHITECT

VOL. CXIX

WEDNESDAY, MARCH 23, 1921

NUMBER 2361



LOBKOVIC PALACE

Prague—As a City of the Baroque

PART III.

By SELWYN BRINTON, M.A.

IN a lecture delivered in December last by Mrs. Arthur Strong, LL.D., Lit.D., F.S.A., on the subject of the "Baroque Art of the Counter-Reformation, and Bernini's Work on St. Peter's Rome," the Assistant Director of the British School at Rome pointed out that, while barely a hundred years after Bernini's death his art had begun to be discredited by the neo-classicists, and soon became anathema to the leaders of the romantic movement and the didactic school which had its exponent in Ruskin, in our own days a sounder knowledge of history and a sounder perception of what was great and permanent in the laws of art and architecture were rapidly helping to dispel these prejudices.

In approaching my subject here, in which I have to treat the baroque city of Prague as distinct from that wonderful mediæval city which has been before us in the two preceding articles of this series, I have quoted these words of Mrs. Arthur Strong—from

which she went on to allude to the good work being done now by English critics and architects towards the study of Bernini's work in Rome, with which she included in very kind terms a set of papers on the Baroque which I had contributed to "The Builder" some few years ago—because they seemed to me to express most justly the attitude of the most advanced modern thought among architects and others towards the whole baroque movement. While fully and willingly admitting the faults of that movement, which justly drew down the vials of wrath of John Ruskin and his contemporaries, we have come to realize that the same movement had great merits, that it was itself a necessary reaction from the Academic Classicism of the followers of Palladio—that in a word it takes its place—and that, too, an important place—in the story of architecture.

In my own papers above mentioned on the Baroque I took Gian Lorenzo Bernini as the protagonist of

THE AMERICAN ARCHITECT

the movement, because that marvellous artistic genius, at once a sculptor of the highest order and a very great architect, within his life in Rome, a city which he may be almost said to have recreated, was the center and focus of the new movement—a movement which externalized the Counter-Reformation, and was throughout, as Sir Banister Fletcher points



CHURCH OF ST. STRAHOV

out, connected with the Jesuits in its progress, adopted by them for its essentially modern character, and is to be studied architecturally in the churches of that order in Italy and through the rest of Europe.

Bernini's dates are given by the writer just quoted as 1589-1680, and those of two other leaders of the movement, Carlo Maderna, as 1556-1639, and Borromini, Bernini's rival at Rome, as 1599-1667; the date of the battle of the White Mountain, one of the great landmarks in the history of Prague and Bohemia, which invoked the suppression of Protestantism and the final triumph of the Catholic party in that country, was in the close of 1620, and the cruel executions of the Protestant leaders took place in the market place of Prague in June of 1621. I mention these dates to show that the change of political and

religious power in Prague took place just when the influence of the Company of Jesus, with Baroque architecture and sculpture as its handmaid was at its height; and very naturally the Jesuits, when they became dominant in the ancient city, commenced altering and remoulding its architectural side in the churches, and incidentally also its civic architecture. Even from the purely art side that a certain amount of harm was done seems undeniable; anything more blatantly assertive, more vulgar, more lacking in repose or dignity than the interior of the old Hussite church called the Tyn church as it was left by them can hardly be imagined. They seem even to have removed the fine façade built by Podebrad, in which that King's statue pointed with his sword to a chalice on the ground that this was an "Utraquist" emblem. This was done in 1623, two years after the executions, when they even removed the bells of the church because they had been known as "Huss" and "Hieronymus."

On the other hand they were responsible at this very time or soon after for some buildings which Prague could ill spare. The fine church of St. Nicholas, built in the seventeenth century under their in-



STATUE ON CHARLES IV BRIDGE



OLD PALACE

THE AMERICAN ARCHITECT

fluence, on the Malostranske Namesti, is an example; and the old monastery of the Praemonstratensians at the extremity of Mala Strana, which has the name of Strahov (from "straz," a guard) as in old days it was a guard to that entrance of the city, though it had been founded as early as 1142, in its present structure was rebuilt by Italian architects during this same seventeenth century, when its wonderful library, which is most rich in "incunabula," in Oriental manuscript and early printed bibles, must have been brought together and its fine interior designed and covered with paintings, while probably the choice little collection of pictures dates also from this time. Here, too, may be mentioned another monastery, that of the Capuchins on the Loretto Place, with the adjoining church of St. Mary, founded by one of the Lobkovic family, Princess Catherine, who have still their palace in Prague, its chapel of the Santa Casa and rich treasury owes much to the art of the rococo. Even the famous bridge of Charles IV, with its mediæval towers, was adorned under this new influence with groups of statuary, which recall to our mind those which Bernini had set at this very period upon the Bridge of Santo Angelo at Rome; the influence of this new art came, in fact, to permeate the whole city, so that it would be no exaggeration even

now to describe Prague as a City of the Baroque.

Especially is this the case in civil architecture, and it is just here that this architecture of the seventeenth century, adapting itself to its surroundings, and losing something of its original Italian character, becomes for us in this city of extraordinary interest. Walking down, as I did one day last Summer at Prague, from the old fortress Palace of Hradcany to the Jesuit church of St. Nicholas, I passed on the steep descent through a street of which quite two-thirds of the houses, in some cases almost palaces, were absolutely baroque of this period, but with a variety of design, a richness of fancy and invention which was really astonishing. The Catholic Revival in these towns of central Europe and southern Germany, in such cities as Würzburg or Prague has an architectural development which is of exceptional interest, and which would merit more careful analysis than is possible within the limits of a single article. What I hope, however, here, is that, through the excellent set of illustrations of this side of the architecture of Prague which have been kindly placed at my disposal by friends in that city, I may give my readers some idea of this richness, this exuberance of inventive detail in her churches, palaces, sculpture and civic buildings of this time. For this Baroque, with



KINSKY PALACE



STRAHOV LIBRARY

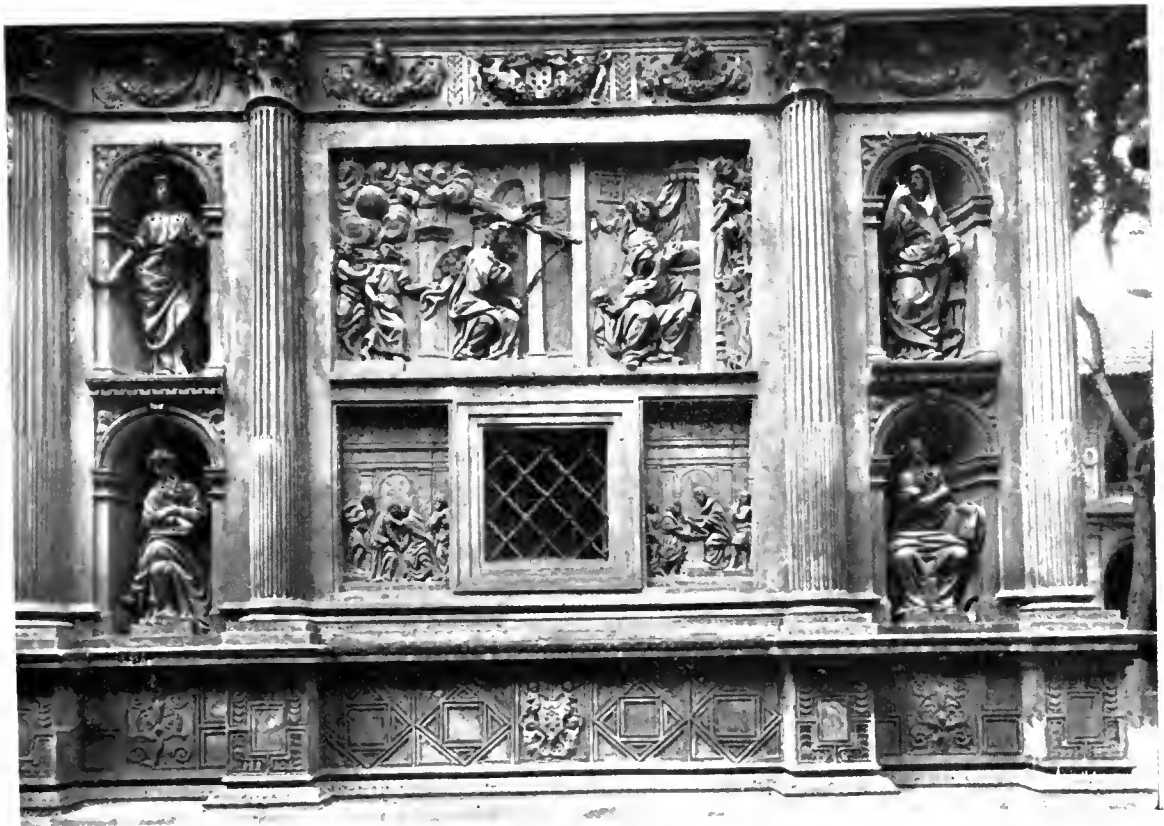

DETAIL, LORETA MONASTERY



CZERNIN PALACE



CHURCH OF THE KNIGHTS OF THE CROSS

THE AMERICAN ARCHITECT

all its demerits, was an escape—an escape from the hard academic rule of form into the world of emotion, of individual caprice and fancy. It was the triumph of the curve over the straight line, of the human element over the weight of accumulated tradition.

Several weeks ago the hulk of the old prison ship Euphenia was uncovered on this same site, buried twenty feet below the sidewalk, and recently excavations of an additional ten feet brought to view an assortment of vases, jugs and other ornaments, large hand-made spikes of cast bronze and hundreds of



STAIRCASE, OLD PALACE

Ancient San Francisco is Unearthed

Workmen Find Relics of Olden Days

Under the sidewalks of San Francisco lies a world of less tragic origin than the ruined city of Pompeii, but one also filled with relics of forgotten years. Less than twenty feet below the seemingly rock-founded streets, the rising and falling tides of the bay still seep in, and old ships lie there imbedded in the mud and silt as they have lain for seventy years—since inlets from the bay ceased to flow over that portion of the bay now intersected by Sansome and Sacramento streets.

Workmen uncovered innumerable small articles of ancient San Francisco.

smaller spikes, all of which have withstood the erosion of time for almost a century below the city's streets.

Beneath the foundations of an old wall on Commercial street the workmen also unearthed several score of small clay pipes, each bowl carved into the shape of a man's head, and many of them as perfect and unmarred as the day when they were made. They are thought to have been the property of early Mexican settlers in that vicinity.

All of these discoveries are not only of romantic and historical interest, but are helpful also in making it possible for accurate determination as to the changing street levels of the city.

The Gotham National Bank Building

SOMMERFELD & STECKLER, Architects—KENNETH MURCHISON, Consulting Architect

NEW YORK'S civic center is slowly moving northward. As short a while as twenty-five years ago Fourteenth St. and Broadway marked the center of the city's activities. Ten years later the northward movement had pushed the center to Twenty-third St., where it remained for about fifteen years. The next

and Broadway. And the Gotham National Bank Building is one of the proofs of the ceaseless northward surge of the business section of the city. This building, taken together with the United States Rubber Company's home, and the tall structure of the Fisk Tire Co. may be said to mark the possible nucleus for a new civic center for New York, and

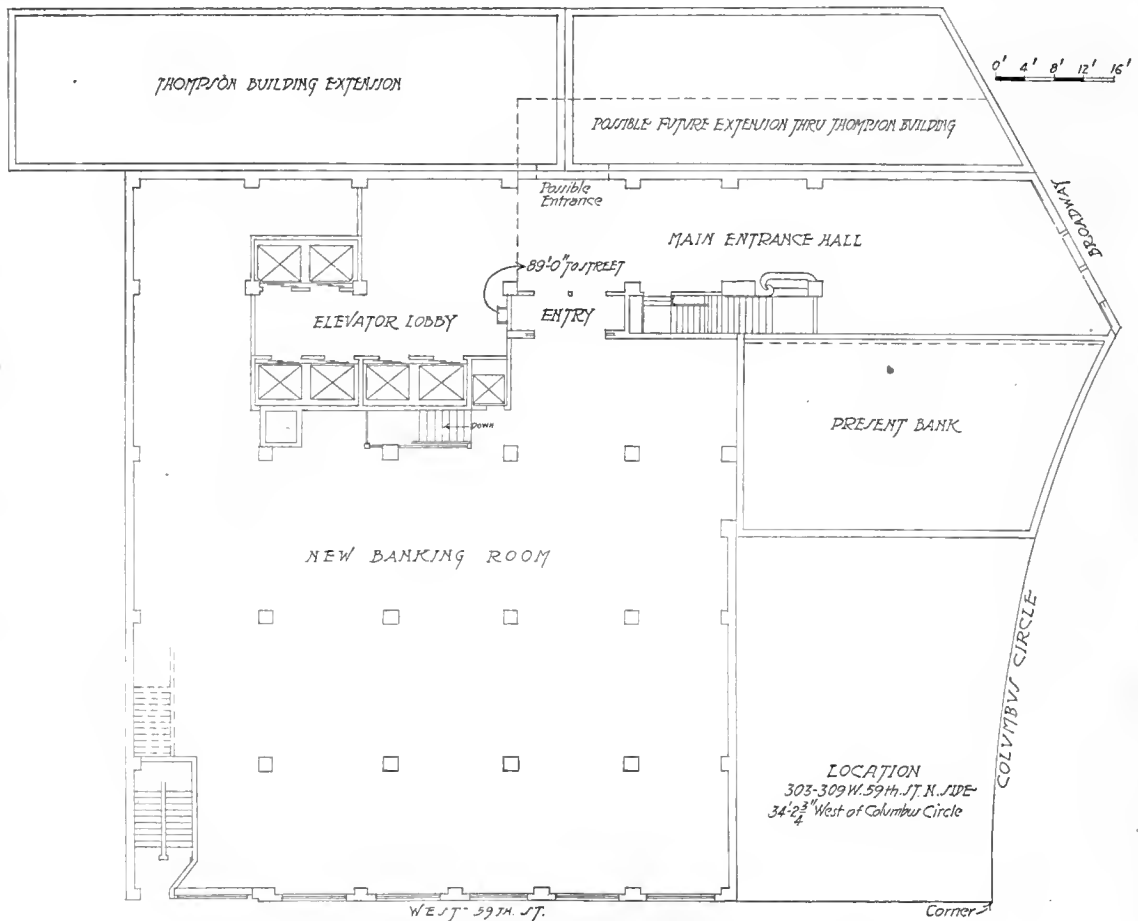

PLAN SHOWING LOCATION OF BUILDING ON SITE

If a building is placed not more than a 100 feet from the intersection formed by 59th Street and Columbus Circle, on a 59th Street, moderate-priced plot, its height is governed, not by the 59th Street regulation, but by the Columbus Circle regulation.

logical northward movement would appear to stop at Thirty-fourth St., but this was essentially a shopping district. It was for that reason that Times Square, at Forty-second St., stands today as the civic center of New York City.

But Times Square finds itself in danger of being supplanted by Columbus Circle, at Fifty-ninth St.

it may not be amiss to think of Columbus Circle as the "Times Square" of the near future.

The keynote of the whole structure is summed up in a statement by one of the architects.

"The bank wanted a building which would produce Broadway revenue for renting space, which would cost them a 59th St. price for the plot, and

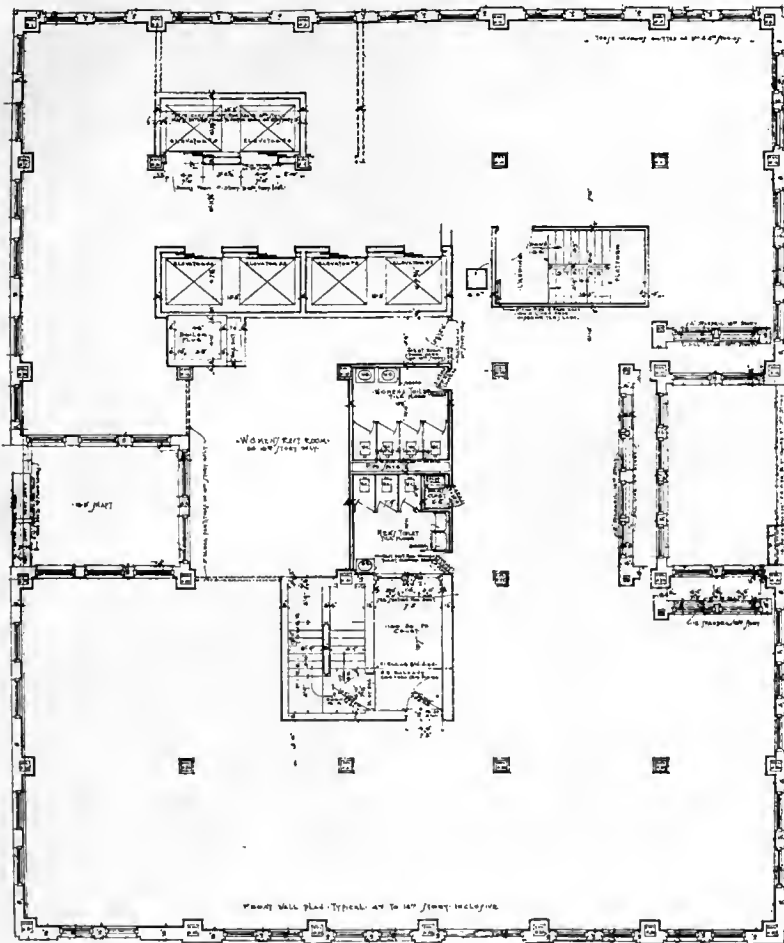

FOURTH TO FOURTEENTH FLOOR PLAN INCLUSIVE

other point of interest to those architects who may have to deal with zoning regulation. The lot to the rear is so located that the rear of the lot upon which the bank building stands comes to the side and not the back, of that lot. The bank building lot is, therefore, "back to side" with respect to the lot on its rear, and not "back to back." This little point eliminated a 40-foot yard the entire height of the building. The very obvious advantage of a 40-foot depth for 18 stories is readily appreciated; and yet it is a matter which only a very careful study and knowledge of existing building regulations would make obvious.

From the 18th to the 24th story there are a series of three setbacks of two stories each and one of one story, as shown in the reproduction of the rendering. These setbacks were treated as two bay windows with ends splayed, so as to avoid the ugly set offs which would occur on the side lot line.

As the three fronts—southerly, easterly and northerly sides—were to be complete elevations, each in itself, on account of the conspicuous position the building occupies (the three fronts being open to the view

which would efficiently house their banking business."

It is a well-known fact that buildings with Broadway frontage produce high rent-revenues, and the architects in this case have succeeded in getting such revenue by giving a Broadway entrance (where the cost of ground is very high) to a building which stands on a 59th St. plot (where the cost of ground is less expensive.

The selection of the plot on 59th St. killed the proverbial two birds with one stone, and illustrate rather strikingly how architects in some instances, may produce high-revenue buildings at moderate cost under the Zone Act of New York City. Columbus Circle is what is known as a two times district. If a building is placed (as is this one) not more than 100 feet from the intersection formed by 59th St. and Columbus Circle, on a 59th St., moderate priced plot, its height is governed, not by the 59th St. regulation (which would be 90 feet) but by the Columbus Circle regulation (which permits a 200-foot unbroken height, without any setbacks up to the 18th story). The obvious advantage in revenue to the owners of the building is readily appreciated.

The physical condition of the lot illustrates an-

of the Central Park entrance), it was necessary to have ornamented elevations, although the easterly and northerly elevations are on the lot line and therefore could not have any projections beyond same.

The southerly or main building, which is on the 59th St. side, was treated in a dormer effect above the 200-foot limit (18th story), so as to permit as much of the front as possible for building purposes which would be on the building line, as is permitted under the Zone Regulations.

An attempt was made to study the three facades in the Renaissance style, but the vast number of windows in the building, the offsets and dormers, as well as the return sides of the easterly and northerly sides of the building, resolving itself into a series of towers on the three sides as shown on the perspective, showed that the Gothic style was the only one that would properly lend itself to this unusual problem.

The interior of the bank is laid out in the Gothic style to match.

A unique departure in bank building construction was introduced in the erection of the building, in that the bank sublet all contracts itself, under

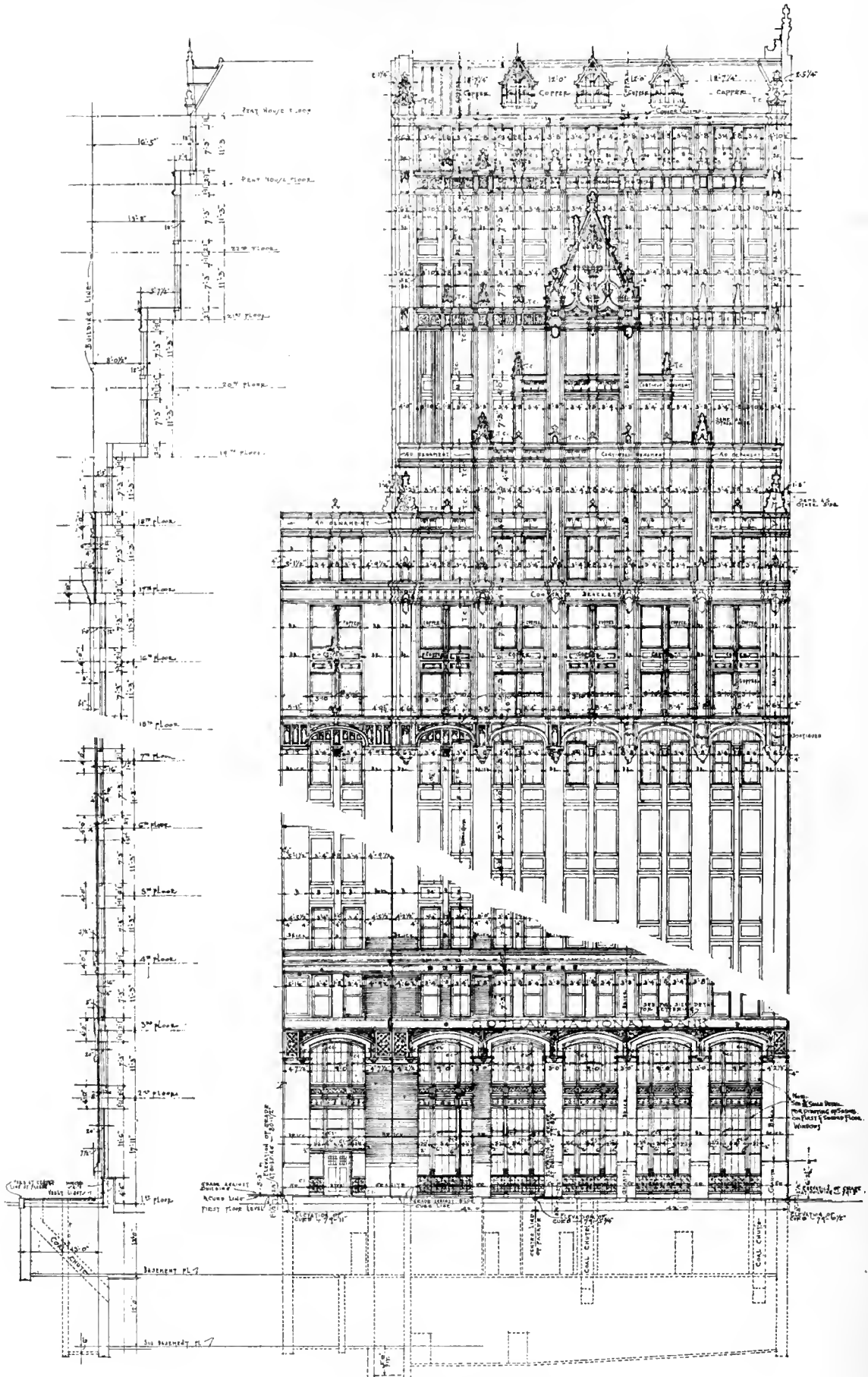

ELEVATION ON 59TH STREET
GOTHAM NATIONAL BANK, COLUMBUS CIRCLE, N. Y.
SOMMERFELD & STECKLER, ARCHITECTS

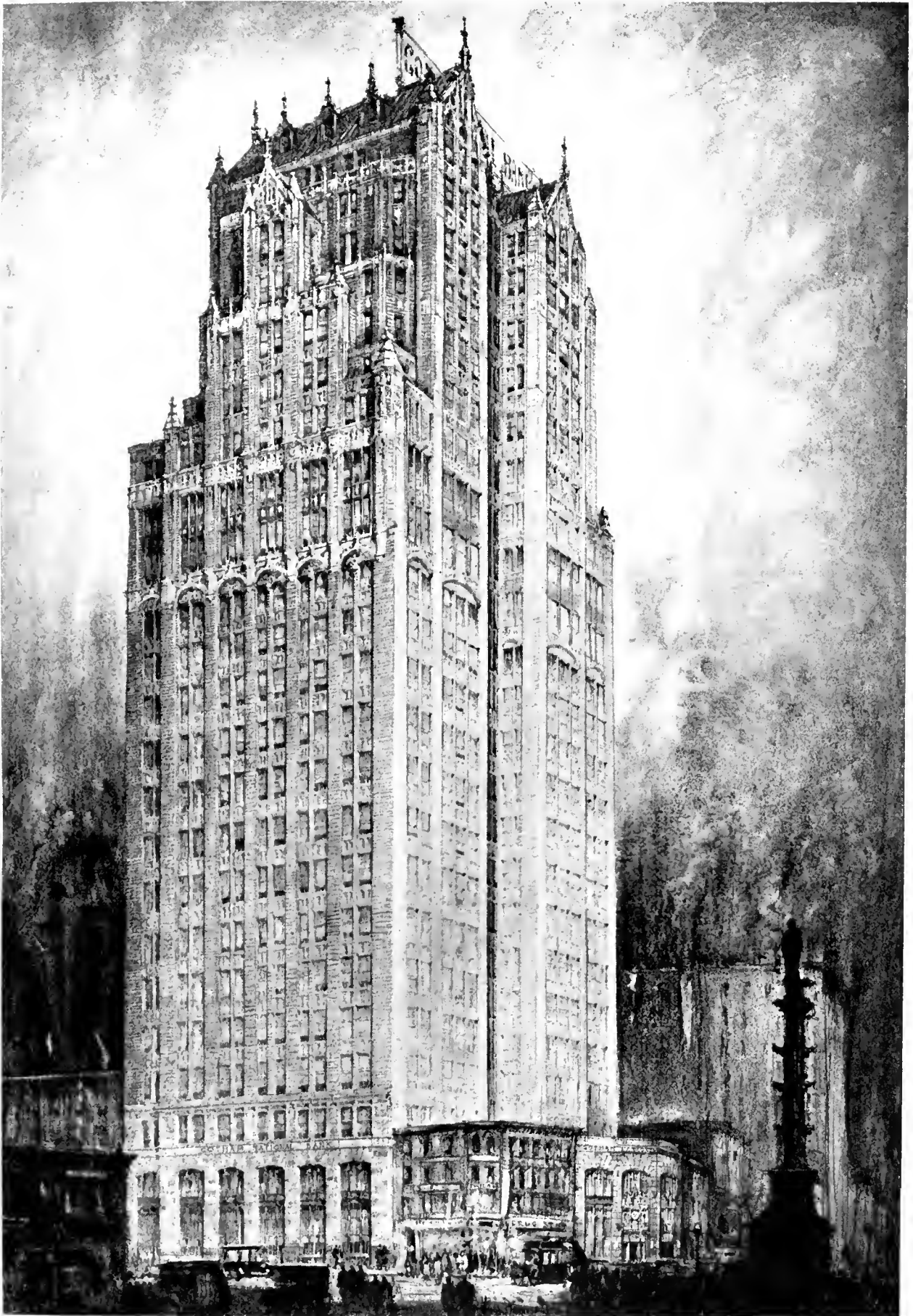

GOTHAM NATIONAL BANK, COLUMBUS CIRCLE, NEW YORK
SOMMERFELD & STECKLER, ARCHITECTS

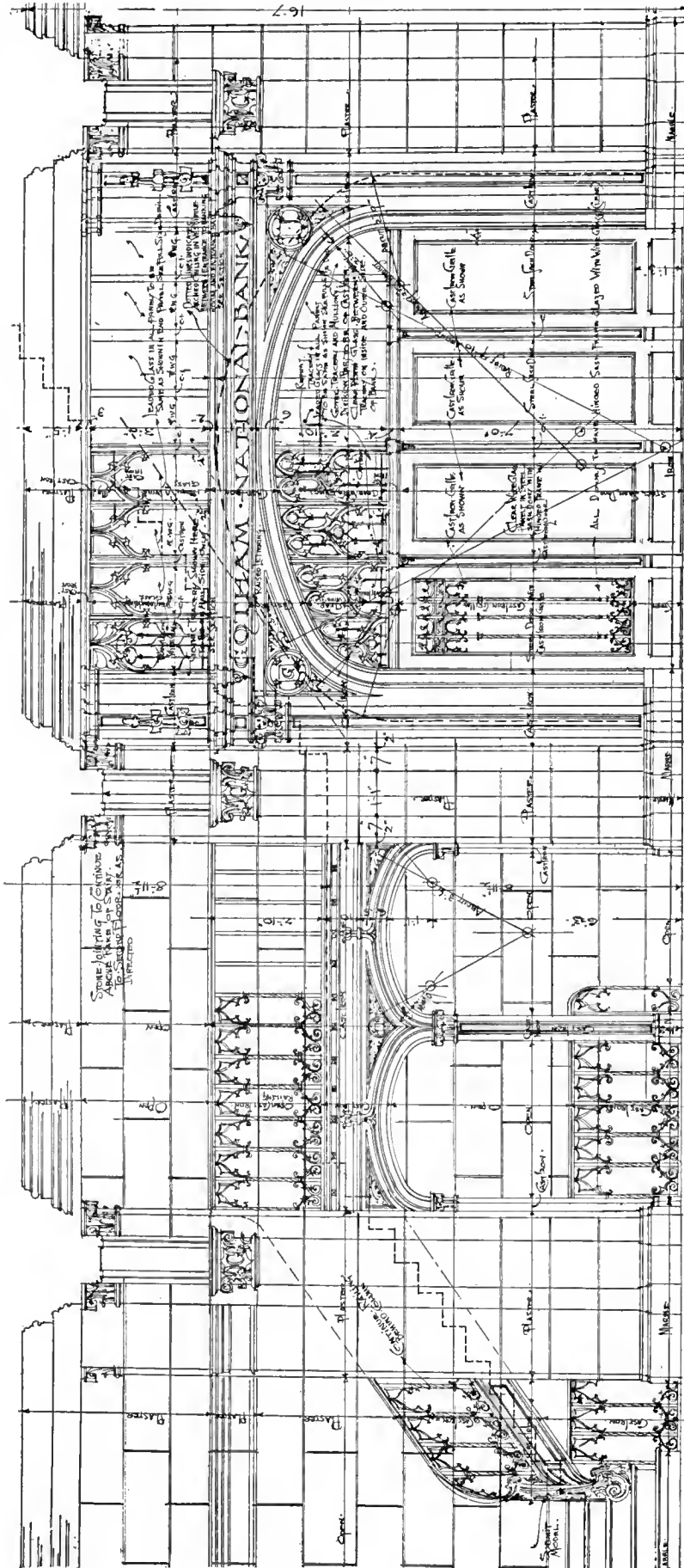

GOTHAM NATIONAL BANK, COLUMBUS CIRCLE, NEW YORK
SOMMERFELD & STECKLER, ARCHITECTS

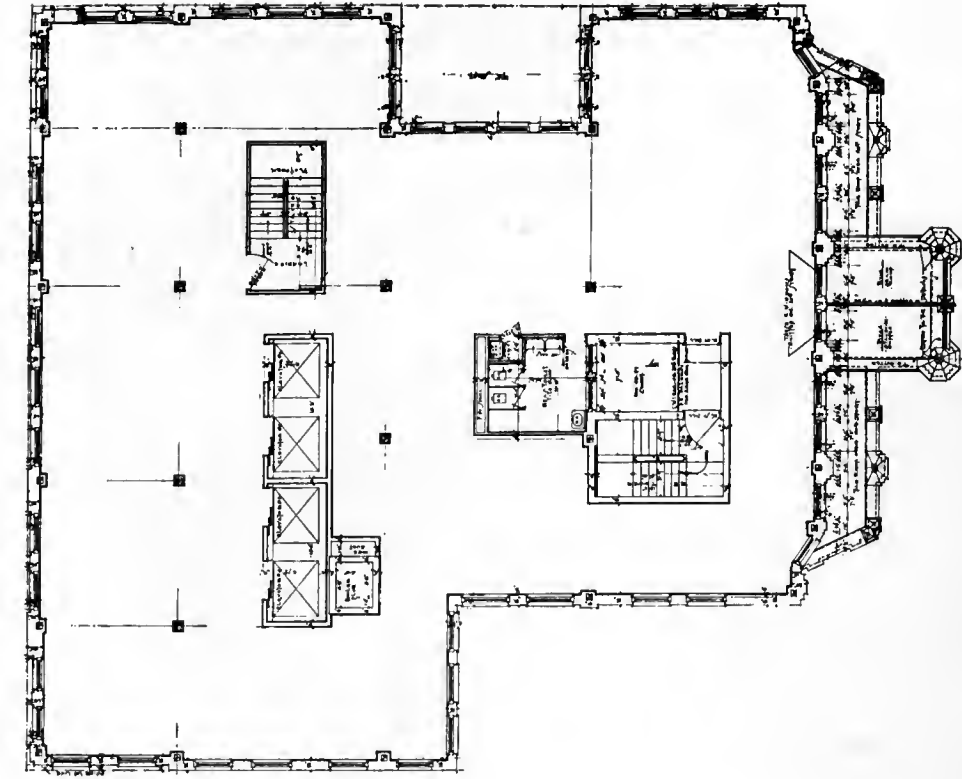

NINETEENTH FLOOR PLAN

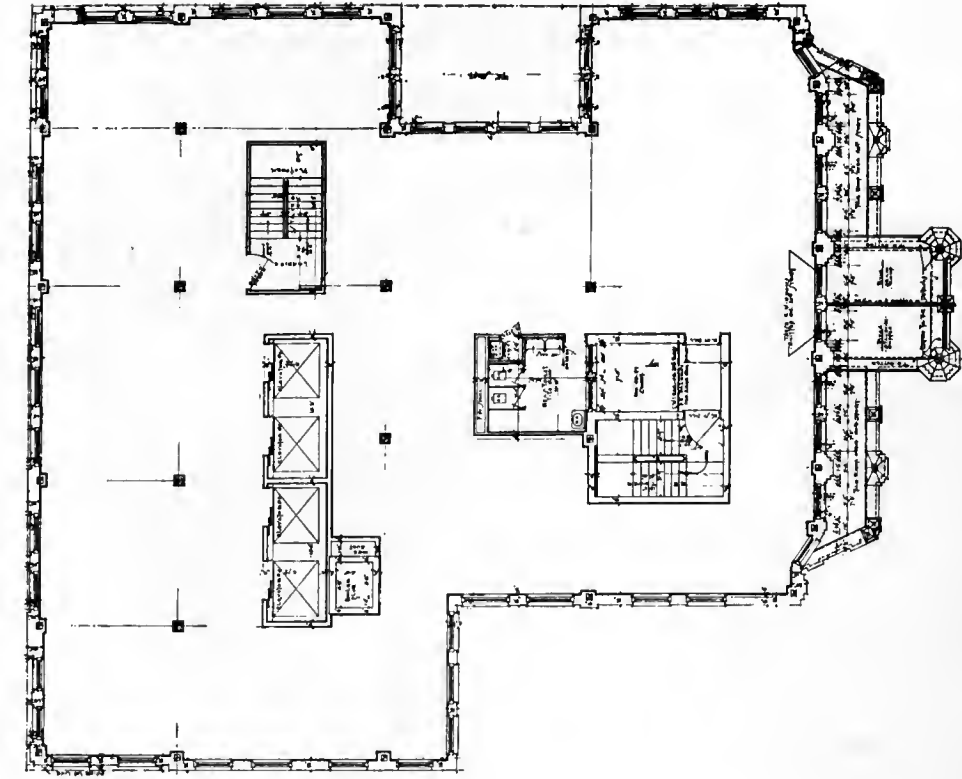

TWENTY-FIRST AND TWENTY-SECOND FLOOR PLAN

GOTHAM NATIONAL BANK, COLUMBUS CIRCLE, NEW YORK
SOMMERFELD & STECKLER, ARCHITECTS

THE AMERICAN ARCHITECT

the direct supervision and charge of one of its vice-presidents. The manner in which the building was erected, its speed and practicability of construction, has proved that this departure was successful.

On July 1, 1920, the first piece of steel was swung into position, and on November 11 the steel work

Mr. Henry I. Oser was associated with the architects from the inception of the work as engineer in all the various features of the construction.



VIEW OF UPPER STORIES

had been completed. There was a six weeks' strike period in this time.

The building is 84 feet by 100 feet; 24 stories high; has six high speed passenger elevators; contains an oil as well as coal burning heating plant; is fireproofed to the point where a sprinkler system was not called for; and rests on concrete-bed rock foundations.

The estimated cost was \$2,250,000.



A UNIQUE AMERICAN CHIPPENDALE MAHOGANY, SERPENTINE FRONT "CHEST ON CHEST." PERIOD ABOUT 1775. FROM THE MYERS COLLECTION

Bismarck's Unique Park

Bismarck, the capital of North Dakota, is to be congratulated upon its plans for the construction of a historical park, adjacent to the State House. It is proposed to employ fifteen acres, a feature being a replica of a Mandan Indian village of pioneer days, with other appropriate historical elements. This is an exceedingly commendable idea and its originator is to be felicitated upon it. In various museums Indian relics are preserved, but nothing is recalled which is comparable to the village symposium as proposed.

Extracts from Competition Program of Scottish Rite Cathedral Competition, Portland, Oregon

REQUIREMENTS OF THE BUILDING

1. *Purpose of the Building.* While certain rooms are indicated below covering the requirements for refreshment, dancing, billiards, etc., the designer should bear in mind that the recreational features of this building are quite incidental to its main purpose although they necessarily occupy considerable space.

It is those gatherings of the Masonic brotherhood connected with the serious and ancient rites of the Order that should determine the character of the building and placing of the emphasis in the design of its forms.

Designers are reminded in this connection that the purpose and function of the Scottish Rite in the Order of Masonry is sufficient unto itself without reference to the rites or forms of other bodies either civil or religious, that this purpose should be expressed as an entity, and that the architectural forms to express and contain it should not partake of the character of our public and governmental buildings on the one hand—nor of the forms of ecclesiastical architecture either ancient, established or modern on the other.

Nothing in the above is intended to preclude the natural working out in both mass and detail of forms that may to a greater or less extent recall conventional architectural forms, but the external application of style-forms to the natural building up of the building itself from the practical requirements and materials of construction, in order to bring the mere appearance of the building within one of the academic categories to which the usual style-word "Gothic," "Classic," or "Greek" and the like have been attached should not be sought for.

Following the wishes of the Board of Trustees as to the architectural character of the building, it should be stated that they do not care to consider any original or individually invented style forms or details, but believe that all architectural material and the character of the building forms necessary to give this building a clean, modern and distinguished appearance may be found in common use in the buildings of American communities. It is that aspect of the architecture of the building which could continue to speak its character and purpose even when viewed at a great distance that should be given the chief attention—such refinement of detail and modest decoration as may naturally appear would be expected to follow as a matter of course.

2. *Position of Building.*—The only entrance to the building (excepting entrance to the janitor's apartment) shall be from Green Ave. The Green St. side of the building shall not, however, be considered as a principal facade, as this building will be generally first seen from Vista Ave. and Washington St. It is, therefore, obvious that all elevations of the building must necessarily be considered of equal importance, although expressing varying functions.

3. *Adjustments in Size.*—As the actual space requirements as set forth below, call for a building, the cost of which will exceed the appropriation, and in view of the fact that certain adjustments between the extent of the undertaking and its cost will have to be made, by the architect appointed to carry out the work, competitors are asked to base their planning on some simple unit base that will admit of reductions in size without unduly disturbing the organization of the building.

4. *Conformity With Laws.*—The professional advisor will check all designs submitted with the building and housing code of the City of Portland and will eliminate all designs that do not conform thereto in all those particulars, concerning plan study and design drawings of this character, may be reasonably expected to give an account.

5. *Construction.*—The designs are to represent a building constructed of brick and terra cotta. Stone is not to be contemplated except as an un moulded and undecorated base course, and the use of such stone shall not extend above the lowest window sills. In case of the building following up the grade the stone may extend to include the lowest window sills of the given portion of the building at the higher grade levels, even though these points should in fact be higher than the lowest window sills in another portion of the building.

6. *Relation of Design Character to Materials of Construction.*—The designers are cautioned against the use of a character and of architectural forms that are typically best expressed in stone and then simply translating the same into brick and terra cotta. The owners are selecting the above materials because they believe them to be the best suited to the circumstances and they do not wish to have built into the forms of the building any suggestion of a wish that the building had been built of other materials which for practical reasons had to be forgone. In the use of terra cotta the jury will not recognize the conventional as-

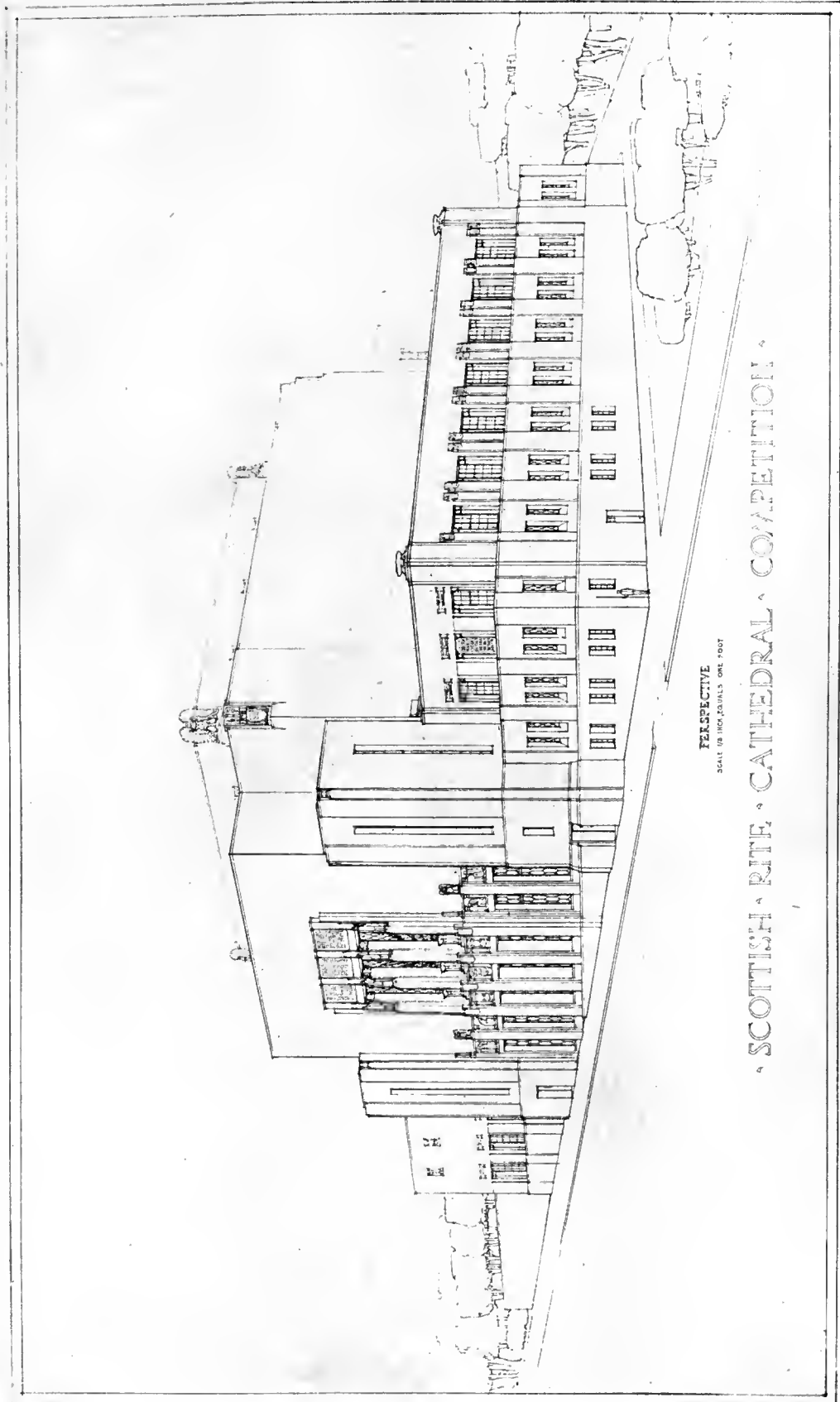

PERSPECTIVE
SCALE 1/8" = 1' 0"

SCOTTISH RITE CATHEDRAL COMPETITION

FIRST PRIZE DESIGN—PORTLAND, ORE.
SUTTON & WHITNEY, ARCHITECTS.

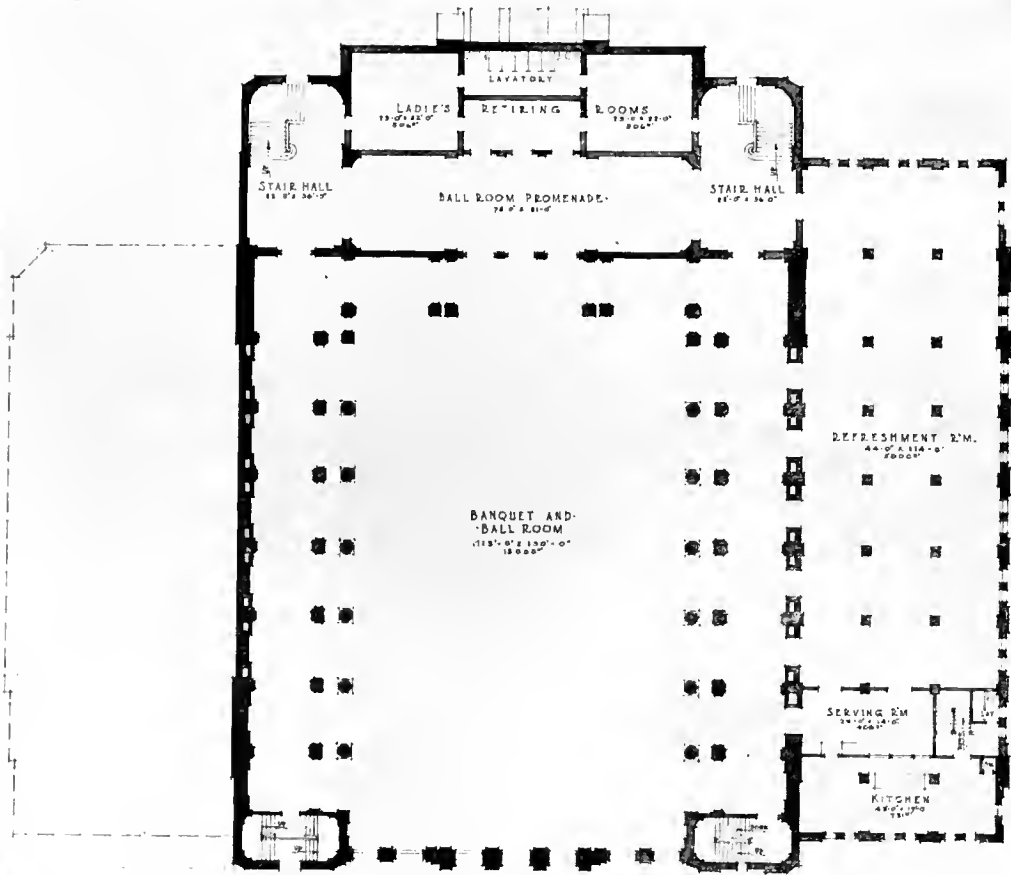

LOWER FLOOR PLAN

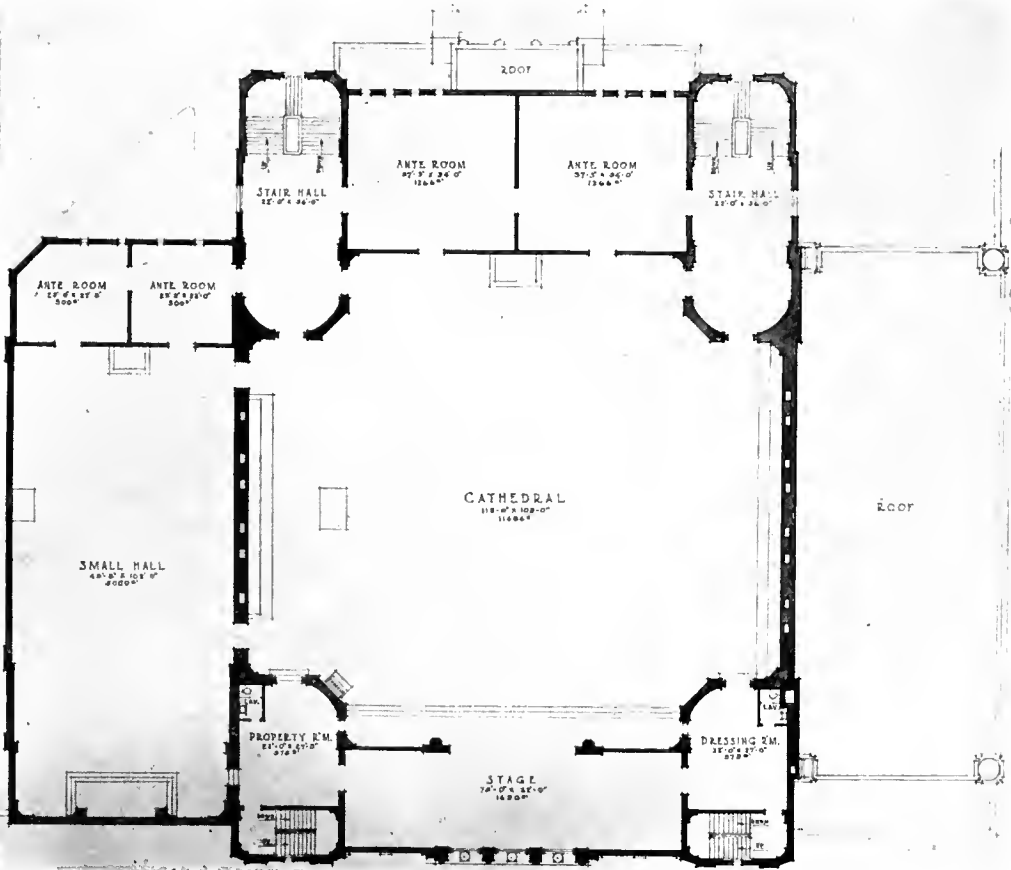

MAIN FLOOR PLAN

SCOTTISH RITE CATHEDRAL COMPETITION, PORTLAND, ORE.
 FIRST PRIZE DESIGN—SUTTON & WHITNEY, ARCHITECTS

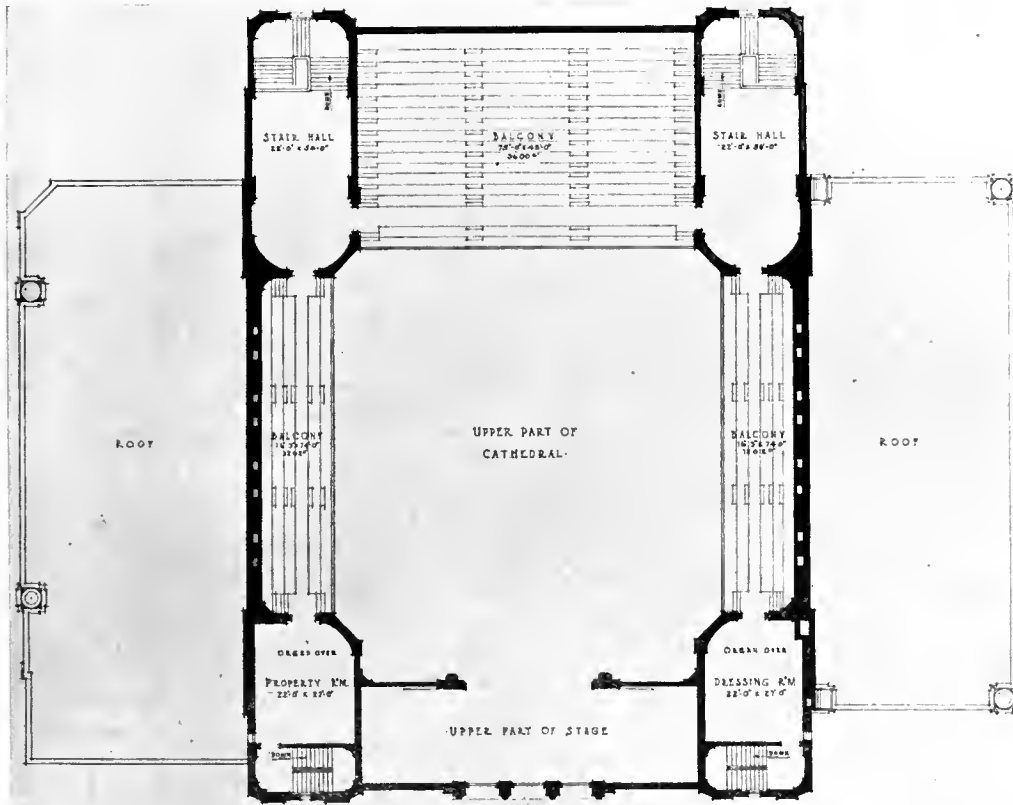

BALCONY FLOOR PLAN

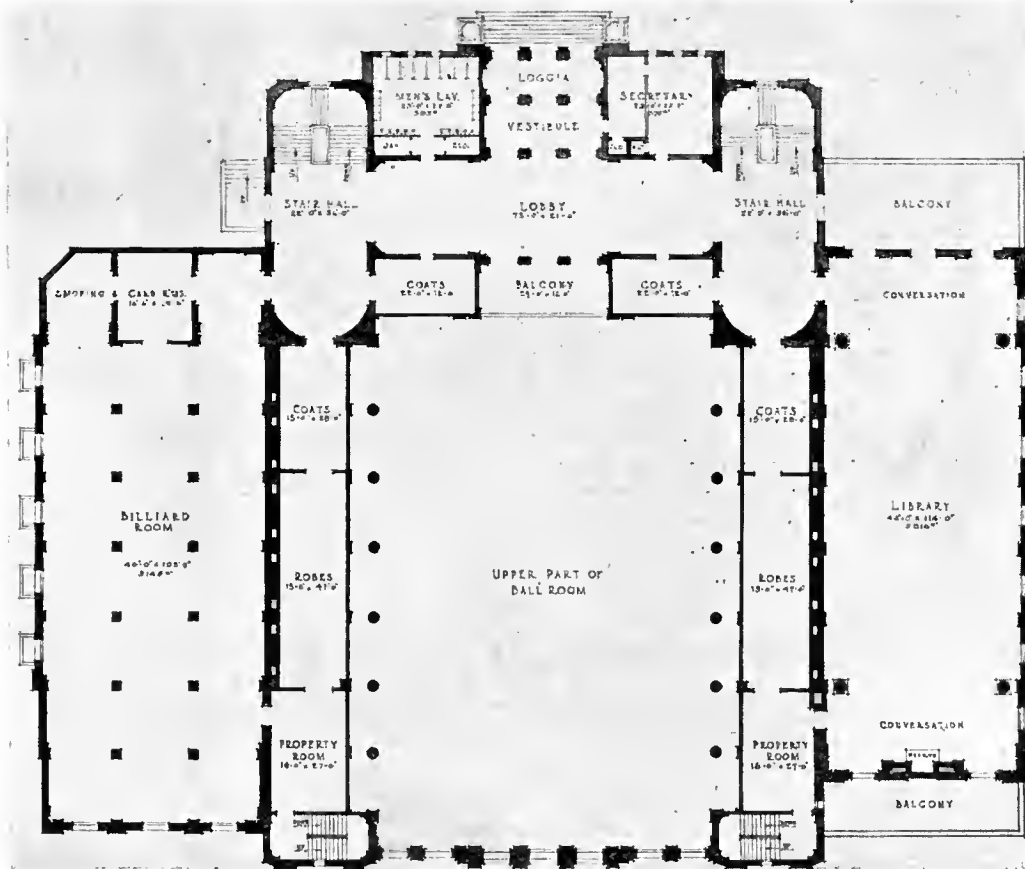

MEZZANINE FLOOR PLAN

SCOTTISH RITE CATHEDRAL COMPETITION, PORTLAND, ORE.
 FIRST PRIZE DESIGN—SUTTON & WHITNEY, ARCHITECTS

THE AMERICAN ARCHITECT

sumption that terra cotta is necessarily a material calling for a high degree of ornamentation or special surface treatment and designers should not endeavor to follow the recently developed draughting conventions which are supposed to give a terra cotta character to the representation of the building. The successful use of terra cotta will for the purposes of this building be determined not so much by appearance as by the understanding displayed by the designer in the possibilities and limitations of the material and its best association with other materials, both structurally and decoratively.

The building will contain the following rooms:

1. PRINCIPAL STORY.

Cathedral Hall, with balcony, to seat 2,500 persons. Two ante rooms, each 1,250 square feet.

2. LOWER FLOOR.

Banquet and ball room of 15,000 square feet in area with a ceiling height over at least 5,000 square feet of this area of 20 feet. Refreshment room and kitchen provide on the lower floor or mezzanine room of 5,000 square feet in area. Janitor apartments, consisting of living room, bedroom, kitchen and bath. Furnace and fan rooms.

REPORT OF THE JURY AS TO PRIZE WINNING PLANS

To the competitors in the competition to select an architect for the proposed Scottish Rite Cathedral for Oregon Consistory Number One, Incorporated.

I am directed to transmit to you the following copy of the report of the jury in the SCOTTISH RITE CATHEDRAL COMPETITION.

The properly authorized jury to decide the competition for the selection of an architect, for the proposed Scottish Rite Cathedral, for Oregon Consistory Number One, Incorporated, of Portland, Oregon, in accordance with the program prepared therefore by William G. Purcell, official advisor to the Board of Trustees, hereby announces the following awards:
First Place.—Design Number Seventeen (17).

The jury is of unanimous opinion that Design Number 17, most clearly and with great distinction meets the conditions set forth in the program.

That "without reference to the rites or forms of other bodies, either civil or religious," and while it does not "partake of the character of our public and governmental buildings on the one hand, nor the forms of ecclesiastical architecture, either ancient, established or modern, or the other," and without involving "original or individually invented style-forms or details," it "expresses the purposes and function of the Scottish Rite in the Order of Masonry—as an entity." That, also, the architectural material and the character of the building—give it a clean, modern and distinguished appearance—which would continue to speak its character and purpose."

Furthermore, this visual aspect is seen to be due to

a frank articulation of the several plan features, arising from a simple and direct solution of practical requirements. The disposition of the banquet hall, refreshment room and kitchen on the same floor; of the library and billiard room on the same floor; of the cathedral and smaller hall isolated; together with consistent and convenient location of stairs and generous provision for circulation for companies numbering a thousand or more; all in a manner to obtain dignified and sumptuous architectural effects—are, in the unanimous opinion of the jury, points of eminent superiority over all other designs submitted.

To Build Model French Town

The plans devised by a French building organization, La Renaissance des Cites, for rebuilding the destroyed town of Pinon, France, as a model for future construction work, were outlined by George B. Ford of New York at a meeting of the Boston Society of Architects. Mr. Ford, who was engaged for eighteen months as consultant with La Renaissance des Cites, illustrates his lecture with lantern slides.

Pinon was situated on a hill not far distant from the spot where a small company of engineers, armed with picks and shovels, were the first American troops to meet the Germans. Not only were the buildings razed, but the hill itself was blown away by mines and counter-mines while Pinon was a part of No-Man's land. The French association, which is composed of the leading engineers, architects and sanitation experts of France, selected the remains of this town, after a thorough search of the war area, as the most logical district for building a model village, which, unlike the average French town, will have a water and sewerage system.

Spain To Use Electricity

King Approves Project to Develop the Country's Water Power

A plan, drafted by the leading electrical experts in Spain to develop electrical energy throughout the country, was presented last night to King Alfonso, who consented to become a patron of the project.

The plan contemplates the construction of enormous electric stations along the principal rivers and railroad lines, extending over 6,500 kilometers. The cost is estimated at 200,000,000 pesetas. The intention is to utilize the water power in the rivers and at the same time to use the poorer quality of coal which abounds in many districts.

In addition to furnishing power for the railroads, the project contemplates distribution of power for agricultural and industrial purposes.

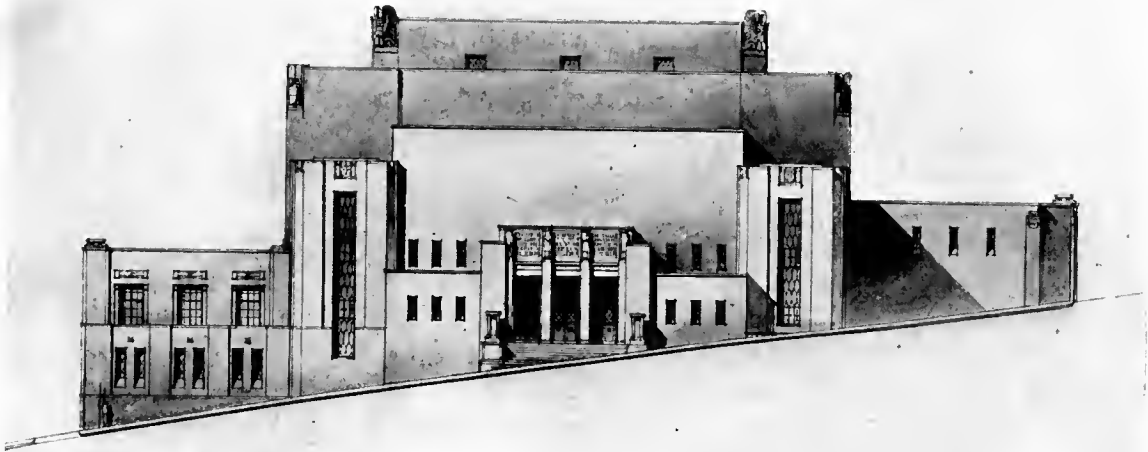

WEST ELEVATION

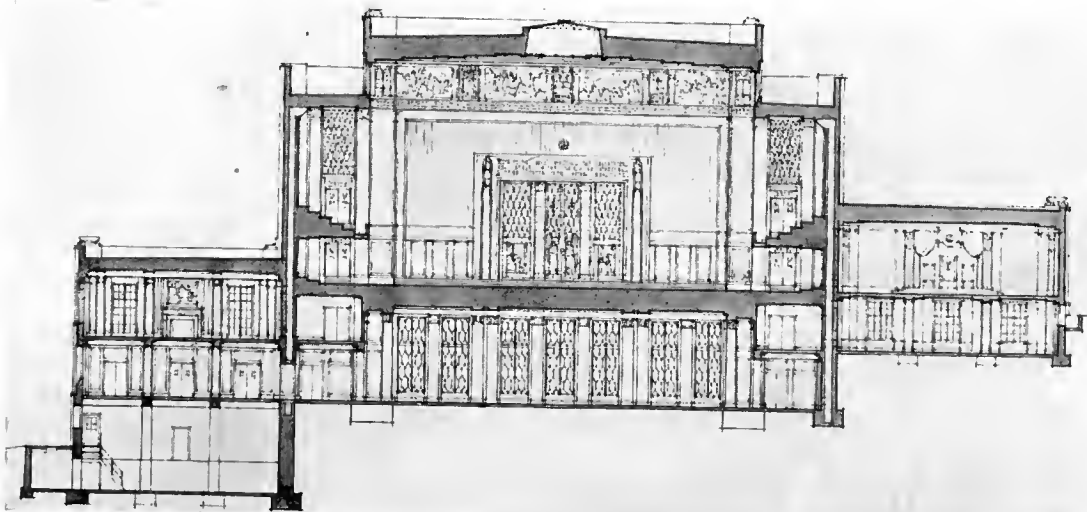

SECTION

SCOTTISH RITE CATHEDRAL COMPETITION, PORTLAND, ORE.
FIRST PRIZE DESIGN—SUTTON & WHITNEY, ARCHITECTS

Christ Church, Philadelphia, Pa.

(See reproduction of original drawing by O. R. Eggers on opposite page)

In many communities during the earlier Colonial period a hobby of architecture was indulged in by prominent citizens who recreatively sought to design and plan important structures. These designs and plans they were able to have executed because of the sufficient prominence of their ownership and ability to dominate the master builders of that day.

In no section of the country have these amateur architects been more in evidence than in Philadelphia and we find that of several remarkable old churches to be found in that city, one of them, Christ Church, which is perhaps the oldest and largest, and the subject of Mr. Eggers' sketch in this issue, was begun in 1727 from designs by Dr. John Kersley, an amateur architect, who happens to have succeeded reasonably well.

It is a pleasure to recall the reverential attitude of the people of Philadelphia for these old Colonial landmarks and it is through this affectionate care that Christ Church is today preserved as near as possible as originally designed and built.

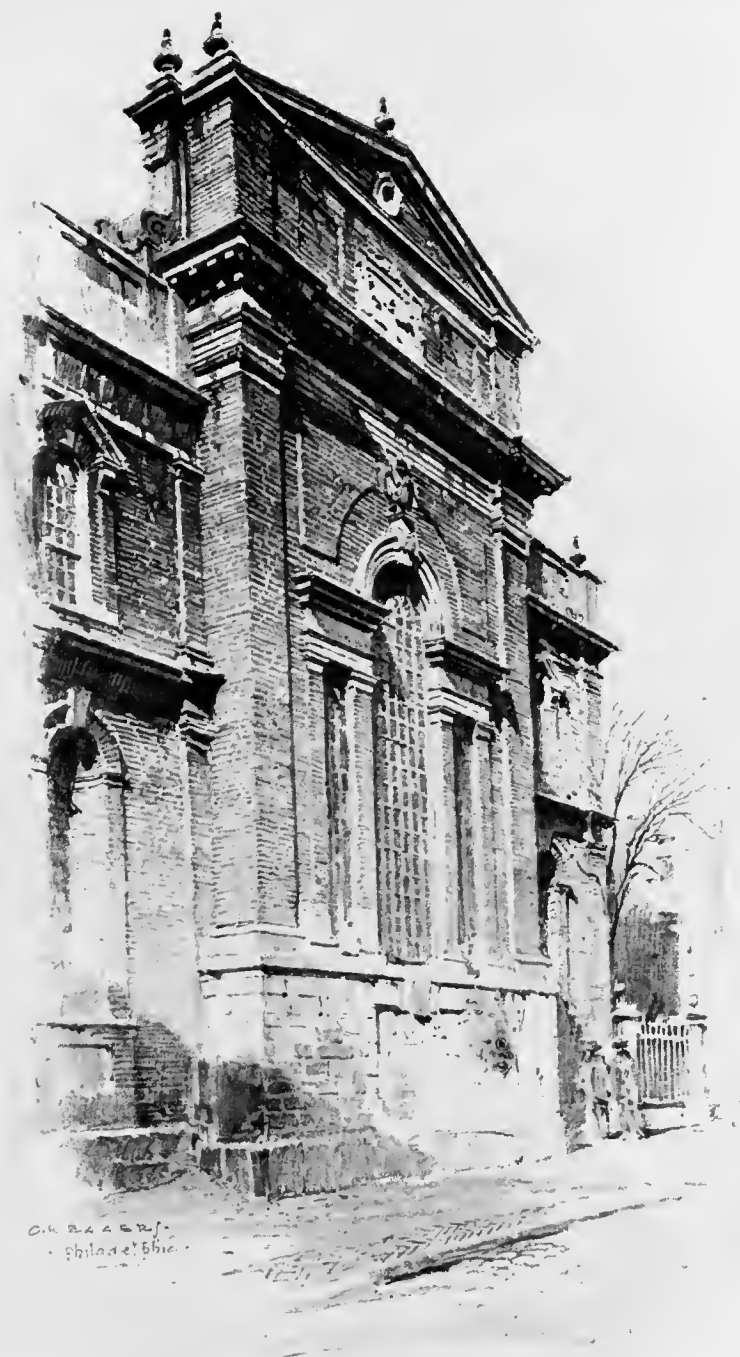

CHRIST CHURCH, PHILADELPHIA, PA.
THE AMERICAN ARCHITECT Series of Early American Architecture

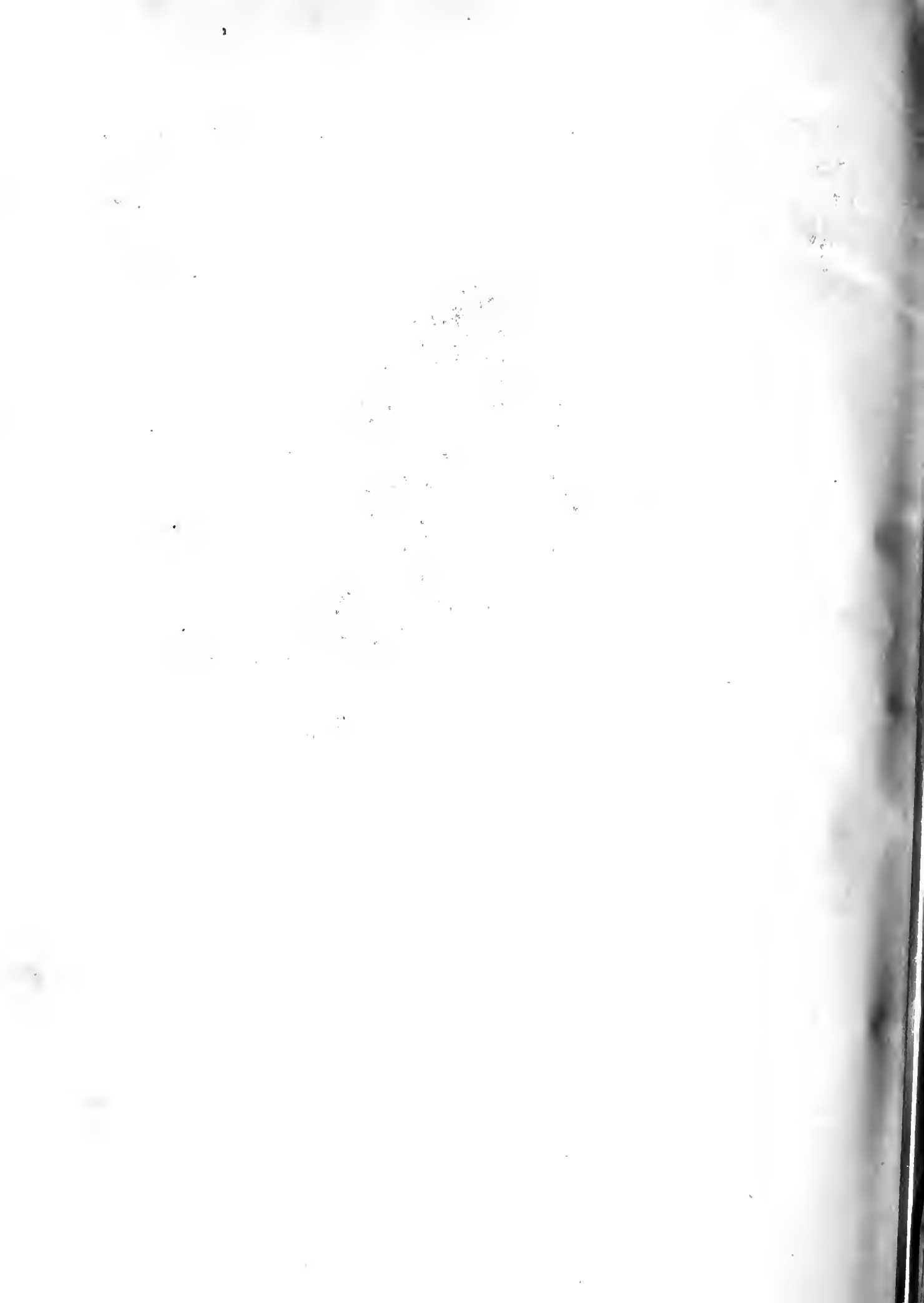



Chicago's Opportunity

THE burning of the Cathedral of SS. Peter and Paul in Chicago has served to call forth expressions of opinion as to the character of the structure that shall replace it. According to the daily press which has printed letters from readers and interviews with Chicago architects, it is firmly a unanimous opinion that the new structure must be Gothic in design, of modern steel construction and the finest example of ecclesiastical architecture ever constructed.

Jarvis Hunt declares the "crying need" of Chicago is "a cathedral that expresses the dignity of religion in the midst of the community." Thomas Tallmadge shares this view and believes that there should be utilized all the knowledge of steel engineering and construction that is available today. Mr. Tallmadge further is of the opinion that by so doing there could easily be designed a structure that would "surpass in height Amiens, Notre Dame or Rheims Cathedral.

Chicago may profit in its plan for a cathedral by the example furnished by New York. It is now more than twenty years since the competition for the Cathedral of St. John the Divine was held. Today there stands but the uncrowned crossing, the chapels and transepts. The architectural history of this structure is too well known to architects to need repetition. Born in one architectural style and now being trained in another, it will be interesting, if any of the present generation live that long, to see what the final result will be.

CHICAGO has been long known as the centre of a region where architects have sought to evolve a national style in architecture. Will it now follow in its design for this new and large religious structure the Gothic precedent of Europe, or will it evolve some great building that will mark an epoch

in cathedral building? The opportunity seems to have arrived. What will the architects of Chicago, unhampered by ecclesiastical authority or an unresponsive building committee, do with it?

"Is it possible," asks the *Chicago Tribune*, "to produce a sincere and original expression of the religious spirit in the materials of today? Is the religious spirit as it exists today sufficiently intense and sufficiently idealistic to produce its own architectural expression?" The answer is, it is and it has.

Why not an American Cathedral? One that will typify religious America and not one that will be typical of foreign peoples? It can be done, and the architects in the Middle West are capable.

Philadelphia Building Trades Work Toward Building Resumption

THE Associated Building Trades of Philadelphia have taken a long step forward toward the active resumption of building.

They urge employers to meet with them and cooperate toward stabilization and standardization of the building industry. In extending this invitation they do not propose to go into any arrangement empty-handed; they meet the situation more than half way. They pledge as far as they can control it, efficiency, maximum production and elimination of their own waste. Nothing could be fairer.

Further, they offer to assist building employers in lowering unit costs, to work for the adoption of better methods, to secure as far as it may be done, continuity of employment and improved management.

Their communication setting forth these promises and outlining conditions as at present affecting the building industry is a most progressive document. It is printed in part in the economics section of this issue.

An Intangible Proposal Worth Millions

The Proposed International Credits Scheme of the League of Nations Can Be Made to Function Without Reference to the League—Would Stabilize the World

Anything having to do with the League of Nations is looked upon askance by Americans, no doubt, but the proposed International Credits Scheme of the Provisional Economic and Financial Committee can be put into force and operated by the important nations of the world without reference to the League and, since it is based upon scientific data and study by the world's greatest economic and financial experts, would do much to stabilize international credit conditions. And what does the world need more at the moment?

Speaking broadly, this is the essence of the scheme:

1. In order that impoverished nations, which under present circumstances are unable to obtain accommodation on reasonable terms in the open market, may be able to command the confidence necessary to attract funds for the financing of their essential imports, an International Commission shall be constituted under the auspices of the League of Nations.

2. The Commission shall consist of bankers and business men of international repute, appointed by the Council of the League of Nations and shall have discretion to appoint agents and sub-commissions and to devote upon them the exercise of its functions.

3. The governments of countries desiring to participate shall notify to the Commission what specific assets they are prepared to assign as security for commercial credits to be granted by the nationals of exporting countries.

Gold Value of Credits

4. The Commission after examination of these assets, shall determine the gold value of the credits which it would approve against the security of these assets.

5. The participating governments shall then be authorized to issue bonds to the gold value approved by the Commission. The bonds shall be in such form, with such date of maturity and rate of interest, as the Commission may decide and shall, in particular, enumerate the assets pledged against the bonds. The denomination of each bond and the specific currency in which it is to be issued shall be determined by the participating government in agreement with the Commission, in accordance with the conditions applicable to the particular transactions in respect of which they are issued.

Bonds as Collateral

11. The fundamental purpose of the scheme being to facilitate and expedite the import of raw materials and primary necessities as well as enable the borrowing countries to re-establish production **especially for export**, bonds secured on the assigned assets shall not be utilized as collateral for credits for the import of other

commodities, provided that where the Commission is satisfied that the import of such other commodities will assist in securing the above purpose, it shall have the discretion to permit special exceptions to the above rule subject to such conditions as it may think fit.

Now, such a scheme as that, divorced completely from the League, and leaving complete autonomy to the various nationals, would work wonders in the stabilization of international credits.

Here is a most important part of the scheme. This would save millions of dollars and tend materially to increase what might be termed the business stability of any nation.

Safeguards for Contracts

16. Pledged bonds shall be dealt with as follows:—
(a) In the absence of any failure by the importer to fulfil his contract with the exporter, the coupons on their due date, and the bonds as they are released shall be returned to the importer who shall return them to his Government forthwith.

(b) In the event of the importer not fulfilling the terms of his contract, the exporter (or his assigns) may either hold the bonds until maturity, or if he prefers he may, at any time, sell them in accordance with the laws and customs of his country, providing that before the bonds are sold a reasonable opportunity shall be given to the issuing Government to repurchase them by paying to the exporter the amount of his claim. The proceeds of such sale shall be applied by the exporter towards covering his claims against the importer. Any surplus not required for this purpose shall be accounted for by the exporter to the participating Government.

(c) Any coupons or bonds returned to the participating Government or purchased by such Government shall be forthwith cancelled in accordance with the regulations to be prescribed by the International Commission; cancelled bonds may subsequently with the approval of the Commission be replaced by other bonds either in the same or in a different currency, in accordance with the conditions governing the original issues of bonds.

It is interesting to note that the Provisional Economic and Financial Committee of the Council of the League of Nations says that an International Conference to discuss general financial questions is undesirable, until 1922.

That so far as questions of finance are concerned, there is no special necessity for the convocation during 1921 of an International Conference to deal solely with the definitive Economic and Financial organization to be established by the League.

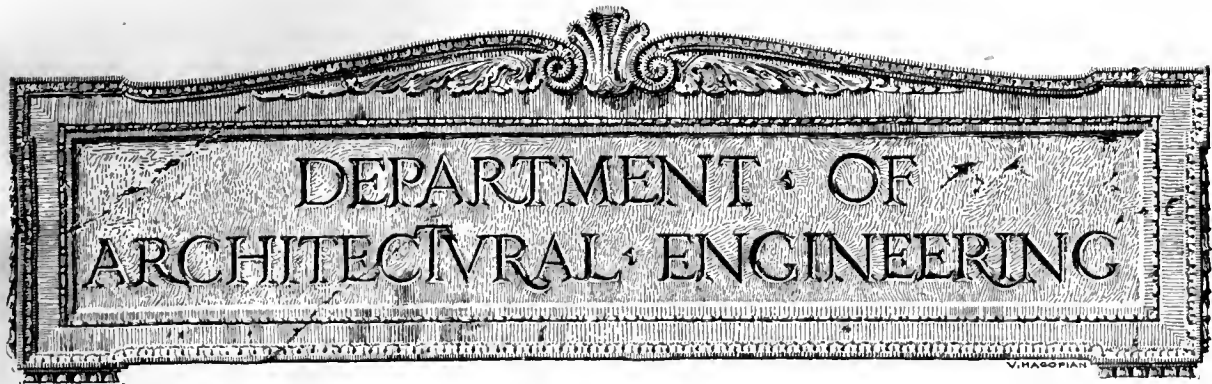

Heating and Ventilating Equipment

The Effect of Recent Investigations Upon the Design and Operation of Heating and Ventilating Equipment

By CHARLES L. HUBBARD

PART I

ACCORDING to the latest theory, the air problem is one of physics and not of chemistry, and the effect of insufficient ventilation begins with the skin and not with the lungs.

Briefly, ventilation, or better, "air conditioning," consists essentially in maintaining the proper temperature, humidity and motion of the air. To these, under special conditions, should be added the removal of dust, fumes, odors and bacteria. While the chemical theory of ventilation has been generally accepted by architects and engineers until recently, there have been doubts as to its soundness among laboratory investigators abroad for a long time. It was not, however, until about 1910 that the newer ideas took definite shape in this country, and by the end of 1914 exhaustive tests had been carried out, with still others under way. The result of this work, which has been continued up to the present time, has been the practical acceptance of the physical theory of ventilation by the American Society of Heating and Ventilating Engineers and the adoption of a Synthetic Air Chart embodying these principles. This chart has been designed for the purpose of measuring with a greater degree of accuracy than heretofore the air conditions existing in any given room, and takes into account temperature, humidity, air motion, dust, bacterial odors and distribution. Carbon dioxide is also considered, but chiefly as a means of determining the air-distribution. Other injurious substances which are found in connection with certain industrial processes are also given due consideration.

Instead of speaking of the ventilation of a room

as good, bad or indifferent, the results of tests are plotted on the chart and the air conditions recorded as a percentage of perfect. This is done by considering all of the known factors which go to make up the air condition, giving to each its due importance in the final result as will be described later.

In view of our present knowledge, it would appear that air has two principal functions, one chemical and the other physical. That is, it aerates the blood and absorbs bodily heat. In order to perform the first of these, it must contain a sufficient amount of oxygen and be free from poisonous gases, and for the second it must have the proper temperature, humidity, and motion to carry away the excess of bodily heat. If the air in a room is not renewed from time to time, or a continuous supply provided, its oxygen is gradually consumed, and furthermore, it becomes laden with heat and moisture and is thus finally unable to perform either of its functions.

ANIMAL HEAT AN IMPORTANT FACTOR

In connection with this condition, it is important to note that the fault develops on the physical side so far in advance of the chemical, that under ordinary circumstances, no attention need be paid to the latter. In other words, any volume of air sufficient to carry away the surplus heat from the body will furnish many times the oxygen required to aerate the blood.

Recent developments in experimental physiology have shown that harm cannot come from rebreathing exhaled air under ordinary conditions, because at each breath we take back into the lungs the "dead-space" air which fills the nose and larger bronchial

tubes, and which constitutes about one-third the volume of a quiet inspiration. Owing to this fact alone, the air of the lungs is always very "impure" and never approaches the purity of the surrounding atmosphere because under the most favorable conditions, it must be mixed with at least one-third exhaled air. As a matter of fact, the air is only partly expelled from the lungs at each breath, so that the entering mixture of pure and exhaled air is again lower in chemical purity to a point far below that found in the most poorly ventilated room. Therefore the process of respiration is not one of filling the lungs with pure air at each breath, but simply of admitting enough to maintain a certain chemical standard by means of dilution.

A DEFICIENCY OF OXYGEN MEANS FASTER BREATHING

If the surrounding air is lacking in the normal percentage of oxygen, we simply breathe a little faster to make up the deficiency, and the amount of oxygen supplied to the lungs is thus maintained without regard to the purity of the surrounding air for all usual conditions encountered in ventilating work. The rate of respiration is controlled automatically by the amount of carbon dioxide dissolved in the blood. If this falls too low, stimulation of the nerve center controlling respiration fails to take place until a sufficient quantity has accumulated. On the other hand, if carbon dioxide accumulates too rapidly, due to the poor quality of the surrounding air, or to other reasons, the rate of respiration is quickened until the increased amount of oxygen taken in neutralizes the carbon dioxide and brings it back to the normal amount. Thus we see that the chemical function of the air is practically automatic and needs no particular attention within a range of conditions much wider than is ordinarily likely to occur.

Coming now to the physical function, it is a known fact that living beings constantly produce and give off to their environment an excess of bodily heat, which in the case of a human adult, amounts to a quantity sufficient to raise the temperature of 1,000 cubic feet of air 15 to 20 degrees F. This heat must be promptly removed from the body, and is carried away partly through the lungs in the expired air, but chiefly through the skin by the processes of radiation, by conduction, through the clothing, and the evaporation of perspiration.

PROPER TEMPERATURE AND HUMIDITY ESSENTIAL

In view of this it is evident that a comfortable and healthful condition can only be secured by surrounding the body with air at the proper temperature and humidity. If too hot, radiation and conduction are prevented; if too humid, the evaporation of perspiration is interfered with. Furthermore,

if there is no air movement, a layer, both too hot and too humid, is soon formed next to the body, even though the general air conditions of the room are satisfactory.

When many people are crowded together in a small space, the air soon becomes too warm, due to the heat given out from their bodies, and its distressing effect is added to both by its stillness and by the moisture exhaled with the breath. More and cooler air must be supplied, but it should be borne in mind that what we generally recognize as "fresh" air does not depend upon its richness in oxygen, nor upon the absence of carbon dioxide, but upon its ability to take away heat and moisture; in other words, a lower temperature, less humidity, and an increased air movement are required. In order to carry away the heat given off by human bodies without admitting air at such a low temperature as to create uncon-

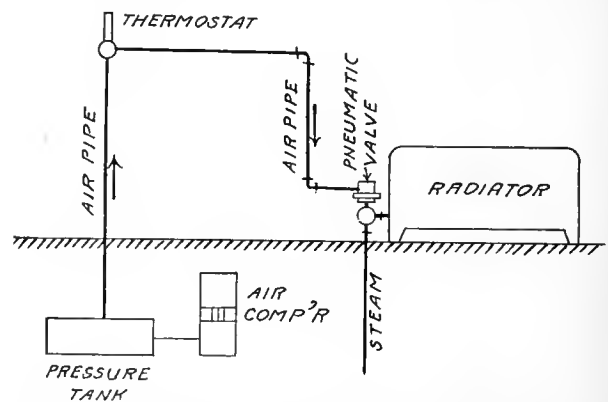

FIG. 1. DIAGRAM SHOWING THE ESSENTIAL PARTS OF A PNEUMATIC SYSTEM OF TEMPERATURE CONTROL

fortable or dangerous drafts, and also to avoid overheating, on the other hand, it is necessary to supply about 2,000 cubic feet of air per hour per person, which curiously enough corresponds closely with that supposed to maintain the proper degree of purity under the older theory based on chemical standards. This is a fortunate coincidence, as it greatly simplifies the adaptation of systems already installed to requirements based upon the more recent theory of ventilation, and thus makes easy the practical transition from one theory to the other.

In the laboratory experiments referred to, it was found that certain combinations of temperature and humidity gave the greatest comfort to the occupants of the test room. For example, with a temperature of 68 degrees, a relative humidity of 44 per cent. was the most satisfactory; for 70 degrees, 36 per cent.; for 72 degrees, 28 per cent., etc. Using this relation as a standard, temperatures ranging from about 3 degrees below the ideal, for a given humidity, to 3

TABLE I

Room or dry-bulb temp. degrees	Relative humidity for different wet-bulb temperatures			
	At rest, 56 deg. per cent.	Light work 54.5 deg. per cent.	Moderate work 53 deg. per cent.	Hard work 51.5 deg. per cent.
68	47	41	35	29
70	41	35	30	24
72	35	30	25	19

degrees above, are considered as constituting a "comfort zone." That is, for a relative humidity of 36 per cent., any temperature between 67 and 73 degrees will be found comfortable, with a maximum of comfort at 70 degrees. The relation between temperature and humidity for the highest degree of comfort, in still air, as determined by the Chicago Commission on Ventilation some years ago, is $R = 316 - 4 T$, in which

R = The relative humidity (per cent).

T = The room temperature, in degrees F (for any temperature above 55 degrees).

For example, at 70 degrees, the relative humidity should be

$$R = 316 - (4 \times 70) = 36 \text{ per cent.}$$

The Synthetic Air Chart, previously mentioned, has been revised some eight times since its original appearance in 1912 and varies slightly from the above, taking into account whether the person is at rest or engaged in light, moderate or hard work. This, for still air, assumes an ideal wet-bulb temperature of 56 degrees for the first condition noted above, 54.5 degrees for the second, 53 degrees for the third, and 51.5 degrees for the fourth. Using these figures,

and referring to a psychrometric table for the corresponding humidities, with room or dry-bulb temperatures of 68, 70 and 72 degrees, we have the following, as shown in Table I, in which the condition of "light work" calls for humidities corresponding most nearly with those given by the formula $R = 316 - 4 T$.

Table II (made up from curves on the air chart) gives the proper wet-bulb temperatures for different degrees of physical exertion, taking into account the air motion, from a state of rest to 200 feet per minute velocity. After obtaining the desirable or ideal wet-bulb temperature from Table II for the condi-

TABLE II

Air motion, feet per minute	Physical State			
	At rest	Light work	Moderate work	Hard work
	Desirable wet-bulb temperature			
	degrees.	degrees.	degrees.	degrees
0	56	54.5	53	51.5
20	57	55	54	52.5
40	57.5	56	54.5	53
60	58	56.5	55	53.5
80	58.5	57	55.5	54
100	59	57.5	56	54.5
120	59.5	58	56.5	55
140	60	58.5	57	55.5
160	60.5	59	57.5	56
180	61	59.5	58	56.5
200	61.5	60	58.5	57

tions of air movement and degree of exertion, a suitable combination of room or dry-bulb temperature and relative humidity can be selected from a psychrometric table, a portion of which is included in Table III for purposes of illustration.

The figures in Table III are taken from complete tables, published in pamphlet form by the Wheeler Condenser and Engineering Co.

EXAMPLE

Moderate work is to be carried on in a room kept at a temperature of 68 degrees during the heating season. The average velocity of air movement through the room is 20 feet per minute. What relative humidity should be maintained to give the greatest degree of comfort?

Looking in Table II, in the column marked "moderate work," on the line corresponding to 20 feet velocity, we find the ideal wet-bulb temperature to be 54 degrees. Now referring to Table III we find for a room temperature of 68 degrees, it will be necessary to maintain a relative humidity of 39 per cent. to give the desired wet-bulb temperature of 54 degrees.

EXAMPLE

A certain mechanical process requires a relative air humidity of 66 per cent. and light exertion on the part of the operatives. What room temperature (dry-bulb) and air motion should be maintained to produce maximum comfort?

We find from Table III (3rd column) that a rela-

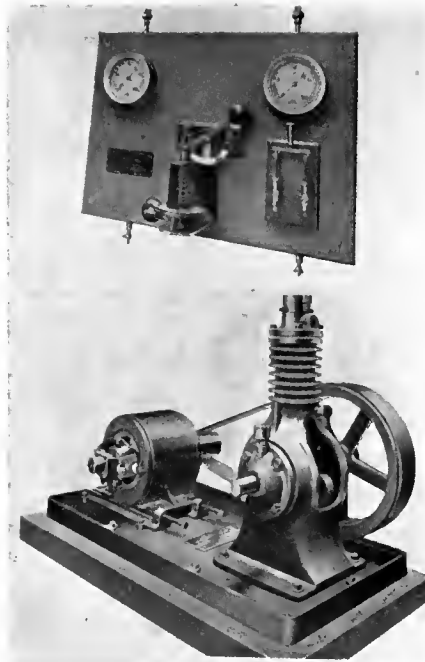

FIG. 2. MOTOR-DRIVEN AIR COMPRESSOR WITH SWITCH AND AUTOMATIC STARTING DEVICE

TABLE III

Room or dry-bulb temperature	Wet-bulb temperature	Relative Humidity	Pounds of moisture per 1,000 cu. ft. of air	Room or dry-bulb temperature	Wet-bulb temperature	Relative Humidity	Pounds of moisture per 1,000 cu. ft. of air
62	60	90	0.797	68	60	63	0.679
..	59	84	0.743	..	59	59	0.635
..	58	80	0.708	..	58	55	0.592
..	57	74	0.655	..	57	51	0.549
..	56	69	0.611	..	56	47	0.506
..	55	65	0.575	..	55	43	0.463
..	54	60	0.531	..	54	39	0.420
..	53	55	0.487	..	53	35	0.377
..	52	51	0.451	..	52	31	0.334
64	60	80	0.757	70	60	56	0.643
..	59	75	0.710	..	59	52	0.597
..	58	70	0.662	..	58	48	0.551
..	57	65	0.615	..	57	45	0.517
..	56	61	0.577	..	56	41	0.471
..	55	57	0.539	..	55	37	0.425
..	54	52	0.492	..	54	34	0.390
..	53	48	0.454	..	53	30	0.344
..	52	44	0.416	..	52	26	0.298
66	60	71	0.716	72	60	50	0.612
..	59	66	0.666	..	59	46	0.563
..	58	62	0.626	..	58	43	0.526
..	57	58	0.585	..	57	39	0.477
..	56	53	0.535	..	56	35	0.428
..	55	49	0.494	..	55	32	0.392
..	54	45	0.454	..	54	29	0.355
..	53	41	0.414	..	53	25	0.306
..	52	37	0.373	..	52	21	0.257

tive humidity of 66 per cent. calls for dry-bulb and wet-bulb temperatures of 66 degrees and 59 degrees, respectively. Now looking in Table II, in the column headed "light work," we find a wet-bulb temperature of 59 degrees calls for an air movement of 160 feet per minute for the greatest comfort.

The Synthetic Air Chart, and directions for its use, may be found in the transactions of the Society of Heating and Ventilating Engineers for May, 1920. This has been prepared especially for the use of engineers and inspectors who have a large amount of this kind of work to do, and makes a very convenient and compact method of recording observations and plotting results.

The tables given in the present article, with the exception of Table III, have been made up from data taken from the curves and scales of the chart, and will be found convenient for the use of architects in connection with their own work.

METHOD OF TAKING MEASUREMENTS

In making an investigation of a given room, first take the wet-bulb and dry-bulb temperatures, and measure the air movement under average working conditions. The temperatures are easily taken with a sling psychrometer, and the air velocity approximated by means of an anemometer. It should be noted, however, that this instrument is not very accurate for low velocities, below 100 feet per minute, and it should be calibrated by attaching to a revolving arm and moving it by hand, or other means, at velocities of 20, 40, 60, 80 and 100 feet per minute,

and noting the correction to be made to the dial readings for these velocities. In making tests for air movement, the anemometer should be placed at different points in the room and the average of the different readings taken for the final result. Very slow movements of air may be approximated by smoke tests if an anemometer is not available or fails to give satisfactory results.

Having taken the wet-bulb temperature and air movement, look in Table II for the *desirable* or *ideal* wet-bulb temperature corresponding with the measured air velocity and *physical state* or nature of work to be done. Next find the difference between the actual and ideal wet-bulb temperatures, and look in Table IV for the percentage of perfect, corresponding to this difference. This gives the relative condition of the air as regards temperature, humidity and movement.

TABLE IV

Wet-bulb difference degree	Percentage of perfect	Wet-bulb difference degree	Percentage of perfect
1	98.2	5	91.0
2	96.4	6	89.2
3	94.6	7	87.4
4	92.8	8	85.6

For example, if the wet-bulb temperature is found to be 60 degrees and the air movement 40 feet per

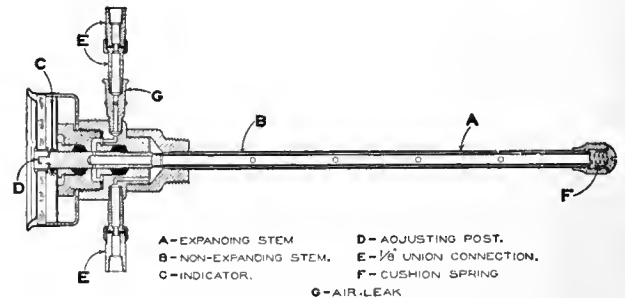

FIG. 3. SECTION SHOWING CONSTRUCTION OF AN INSERTION THERMOSTAT

minute in a room where light work is being carried on, the ideal wet-bulb temperature (from Table II) is found to be 56 degrees, making a difference of 60 — 56 = 4 degrees, which, from Table IV, shows the air condition to be 92.8 per cent. of perfect as regards these three factors.

Dust determinations are next made use of by the use of a direct counting instrument, in which the air is caused to impinge against a cover slip, coated with adhesive material. The particles are counted under a microscope and the result reduced to cubic feet.

The rating on this basis is given in Table V.

If, in the room under consideration, the air was found to contain 60,000 dust particles per cubic foot,

TABLE V

Dust particles per cubic foot of air	Percentage of perfect	Dust particles per cubic foot of air	Percentage of perfect
10,000	99	90,000	91
20,000	98	100,000	90
30,000	97	110,000	89
40,000	96	120,000	88
50,000	95	130,000	87
60,000	94	140,000	86
70,000	93	150,000	85
80,000	92

the rating, as regards this factor, would be 94 per cent. of perfect.

Bacteria determinations are made in accordance with the standard adopted by the American Public Health Association, which are as follows: Four-inch Petri dishes containing standard agar are exposed in the room for two minutes. They are then carefully covered and incubated for 48 hours at 22 degrees, Centigrade. The colonies on the plate are then counted, and the corresponding rating taken from Table VI.

TABLE VI

Number of bacteria colonies on plate	Percentage of perfect	Number of bacteria colonies on plate	Percentage of perfect
10	99	90	91
20	98	100	90
30	97	110	89
40	96	120	88
50	95	130	87
60	94	140	86
70	93	150	85
80	92

In case 30 colonies of bacteria appear, in the illustration, a rating of 97 per cent. should be given for this factor.

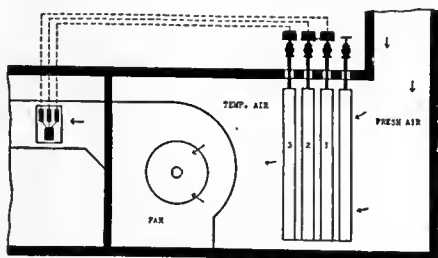

FIG. 4. DIAGRAM SHOWING APPLICATION OF A MULTIPLE THERMOSTAT TO HOT-BLAST HEATING

Odors are determined in accordance with the rating given in Table VII, and tests should be made immediately upon going into the room from the open air.

Let the odor in the present case be *noticeable*, thus giving a rating of 97.7 per cent. perfect.

TABLE VII

Degree of odor	Percentage of perfect
None	100.0
Very faint	99.2
Faint	98.5
Noticeable	97.7
Distinct	97.0
Decided	96.2
Strong	95.5

Carbon dioxide tests are made partly for use in determining the air distribution and partly as an indication of the supply. While the volume of outside air delivered by a ventilating apparatus might be measured with an anemometer, this would take no account of the air change by natural leakage. Furthermore, it is desirable to observe the chemical

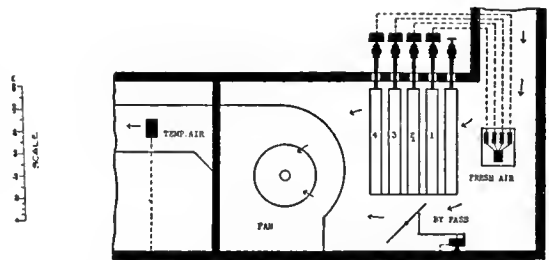

FIG. 5. DIAGRAM SHOWING A COMBINATION OF MULTIPLE AND SINGLE THERMOSTATS IN HOT-BLAST HEATING

condition of the air and to keep it within certain limits in connection with the other factors involved. The most logical method of regulating the supply, to meet this need, is by measuring the carbonic acid content. This requires a collecting bottle with special equipment for filling with air, and is easily done by any one.

The actual analysis should be made by a person ex-

TABLE VIII

Carbon dioxide parts in 10,000	Percentage of perfect	Carbon dioxide, parts in 10,000	Percentage of perfect
5	99.7	16	96.4
6	99.4	18	95.8
7	99.1	20	95.2
8	98.8	22	94.6
9	98.5	24	94.0
10	98.2	26	93.3
12	97.6	28	92.5
14	97.0	30	92.2

perienced in this kind of work, and it is recommended that the Peterson-Palmquist air analysis machine be used. The rating of the carbon dioxide content in the final result is given in Table VIII.

In taking samples, the floor area should be divided into sections of not more than 200 square feet each,

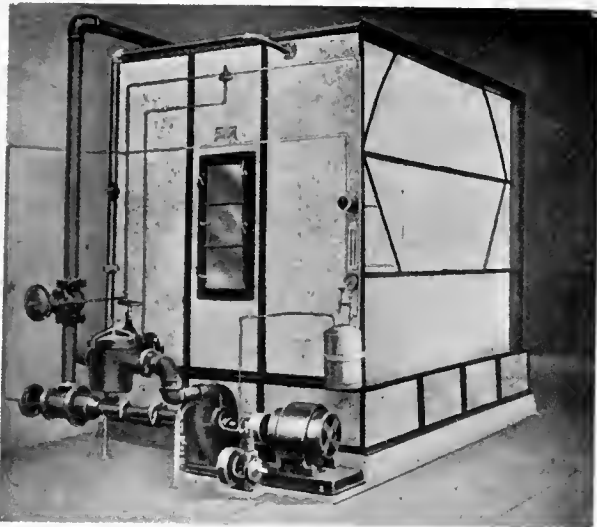

FIG. 7. A TYPICAL AIR WASHER DESIGNED FOR AUTOMATIC HUMIDITY CONTROL

and an air sample be drawn from a point between 2 and 6 feet from the floor, at the center of each section.

The method of determining the air distribution from the carbon dioxide readings is as follows, and is best explained by a practical example.

Suppose four samples are taken, with the following results:

Station	Parts of carbon dioxide in 10,000
1	7
2	9
3	10
4	6
Average $\frac{7+9+10+6}{4} = 8$ parts	

Variation from the average, at each station.		
Station	Variation	Variation
1	8 - 7 =	1
2	9 - 8 =	1
4	8 - 6 =	2

Then the average variation from the average carbonic acid content is $\frac{1 + 1 + 2 + 2}{4} = 1.5$, and the percentage of variation is $\frac{1.5 \times 100}{8} = 18.8$ per cent.

Table IX gives the percentage of perfect, as regards carbonic acid content, for different percentages of variation, as above.

Assuming the above results to be obtained in the example under consideration, we have, from Table VIII, a carbon dioxide rating of 98.8 per cent. of

TABLE IX

Percentage of variation of distribution	Percentage of perfect	Percentage of variation of distribution	Percentage of perfect
2	99.3	22	93.3
4	98.8	24	92.8
6	98.2	26	92.2
8	97.6	28	91.6
10	97.0	30	91.0
12	96.4	32	90.4
14	95.8	34	89.8
16	95.2	36	89.2
18	94.6	38	88.6
20	94.0	40	88.0

perfect, and from Table IX an air distribution of 94.3 per cent. of perfect. (Interpolated.)

Tabulating the various results gives:

Factor	Percentage of perfect, per cent.
Temperature, humidity, motion.....	92.8
Dust	94.0
Bacteria	97.0
Odors	97.7
Carbon dioxide	98.8
Distribution	94.3

The percentage of perfect for the total ventilation of the room, taking into account all of the above factors, is determined as follows:

Percentage of the various factors	Per cent. below perfect
92.8	100 - 92.8 = 7.2
94.0	100 - 94.0 = 6.0
97.0	100 - 97.0 = 3.0
97.7	100 - 97.7 = 2.3
98.8	100 - 98.8 = 1.2
94.3	100 - 94.3 = 5.7
Total per cent. below perfect.....	25.4

Ventilation of room, as a whole, 100 - 25.4 = 74.6 per cent. of perfect.

An examination of the above table shows the first, second and sixth items to need special attention, that is, temperature and humidity, dust, and air distribution.



FIG. 6. PNEUMATIC VALVE OF LATEST PATTERN, SHOWING METAL BELLOWS REPLACING RUBBER DIAPHRAGM

Part II of this article will appear in an early issue and will refer to figures given here.

Giving a Frame Roof a Thatched Appearance

Framing Details of Roofs with Rolled Edges

MANY interesting roofs are now produced by rolling the edges and laying the shingles in irregular wavy lines giving a unique thatched effect. While the framing of such a roof is more or less different from the usual framing it is after all simple as shown in Fig. 1.

The whole roof is given a slightly convex surface by furring on each rafter from four to six inches in height in the center of roof, and diminishing furring to nothing at ridges and eaves. At the gables, furring should be constructed with the greatest care and covered with one inch by two inch shingle strips running with the roof rafters, which carry the general convex line of roof to meet the running verge board. One inch by two inch shingle strips should also be used on valleys and hips running from eaves to ridges and on eaves running at right angle to rafters.

The construction of furring is of the greatest importance, for with this clumsily or cheaply done, no dexterity in laying the shingles will bring successful and artistic results. At the rounding of the gables, furring should be brought well forward to the verge board and then returned against it, forming in section the arc of a circle. This rounding of the gables is greatest at the ridge and is less at the eaves.

On the main roof, when a decided softening of the gables is wanted, it is often advisable to drop the roof rafters gradually at the ridge for a distance of three or four feet back from the verge board. To be effective, the drop at verge board must necessarily be sud-

den. This roll at gables should be constructed with the greatest care. It has been the fault of some architects and contractors who have used the thatched roof to make the roll at gables too short.

Caution should be used in building the rounded and flat surfaces, to lay the shingle lath or roof boarding with sufficient spacing to allow for ventilation, as a roof properly ventilated will dry off

more quickly after rains, and greatly increase the life of the shingles.

On the rounding of the gables, on the valleys, eaves, hips and quick turns, and the angles between the side walls of a dormer, it is necessary to use shingles which are furnished bent, as shown in Fig. 4.

On the first course at eaves, square butt shingles bent to a 20" radius are used in double thickness, the inside of the butts to be on a plane parallel with the wall of the building. This point is the beginning of a curve, the radius of which is to be not less than 20" to the point of merging with the roof line.

Shingles cannot be bent against the grain or crosswise, to a radius of less than 20". Machinery and other equipment is constructed to bend to this radius, and plans must be drawn accordingly. Shingles bent with the grain or lengthwise, to be used on valleys, gables and hips, can be bent to a 10" radius. They are flexible and can be used on almost any radius, whereas those bent against the grain or crosswise, are not as flexible.

On the rounded surfaces of the eaves it is necessary to use sixpenny nails, nailed as closely to the



HOUSE AT CHAPPAQUA, WESTCHESTER CO., N. Y.
ALFRED BUSSELLE, ARCHITECT

exposed part of the butt as possible. In some cases of very quick turns it is often advisable to back-saw or split shingles into narrow strips. In some cases of quick turns it may be necessary to nail the shingles through the butts. On the balance of roof the regu-

regular waves of shingles shown in Fig. 11, the courses varying in exposure to the weather from one to five inches.

To produce these waves, shingles are sawed at the butts in a variety of special thatch patterns, and laid with the long side of each shingle to the short side of the previous one until the maximum exposure is reached. Then to bring the course down again to the minimum exposure, this procedure is reversed, i. e., the short side of each shingle is laid to the long side of the previous one. This manner of laying the shingles is carried out on each course of the entire roof surface with the exception of the first at eaves. There should be no uniformity in the courses, that is, the wave of each course should vary.

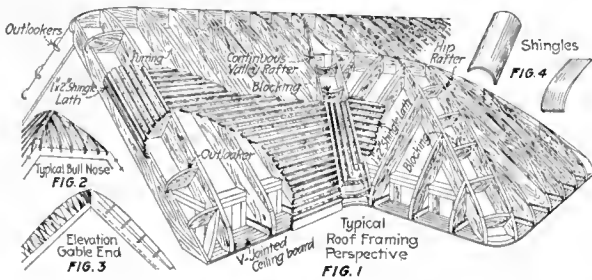

Shingle laths 1" x 2" are laid in usual manner except on Gable Ends, Hips and Valleys. On gable ends laths run parallel to rafters. On hips and valleys the laths run from eaves to ridge.

All rafters are furred from 4" to 6" at the center, diminishing to nothing at the eaves and ridge, giving the roof a slightly convex surface.

lar size shingle nails should be used, preferably of zinc, zinc-coated or copper.

Aside from the rounding of the gables and the softening of the eaves and ridges, the best feature of this roof is the texture produced by the long, ir-

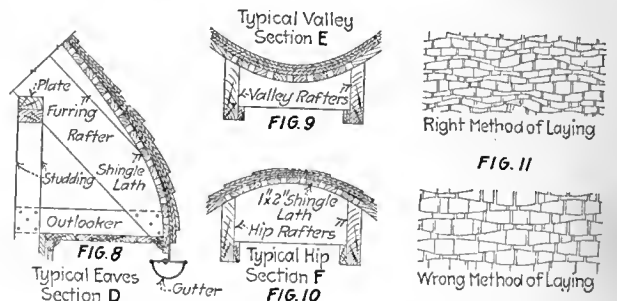

The radius of the roll on the rake should never be less than 10". The blocking projects well beyond the verge at the ridge and decreases toward the eaves.

On the eaves the best effect is gained by laying the shingles from one to three inches to the weather until the flat portion of roof is reached.

The thatched effect is better gained on the flat portion of roof and gable ends by an exposure of from one to five inches to the weather with an average exposure of three inches, rather than from two to five inches with an average exposure of three and one-half inches to the weather, as is sometimes done for economical reasons.

On the rounded ridges, the shingles can be used as shown in Section F or they can be capped with a suitable metal (Section B), preferably copper, rounded to appear from below as a continuance of the shingles. Metal would be somewhat cheaper but not quite so artistic.

The construction of the gutter is shown in Fig. 8. This arrangement does not hide the rounded eaves, and when painted to match the shingles, it accentuates the droop at the eaves when seen at a distance.

Naturally it requires more shingles for a thatched roof than for a regular roof, but it is more durable as the average exposure is less.

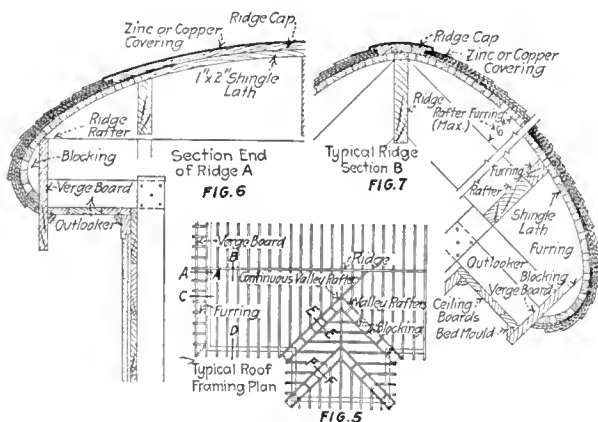

To obtain the best results for the roll of the gables the furring should project well beyond the verge board at the apex and this projection should be gradually reduced toward the eaves.

The drop from the ridge to the verge board should start three or four feet back from the face of the verge board and curve down gradually as shown in the detail above and the perspective below.

On the rounded surfaces shingles should be nailed as closely to the exposed part of the butt as possible with sixpenny nails. Where very quick turns are made shingles should be soaked in water and nailed through the butt.

Of Current Interest

Happenings and Comments in the Field of Architecture and the Allied Arts

The Architect's Service

Members of the architectural profession of Jacksonville, Fla., have exactly the right ideas as to their duty to their community.

In a series of advertisements, one of which is reproduced, they have laid the facts of the present building situation accurately before their clients. There can be no doubt of the value at this time of such well-directed action, and it would be well for architects all over the country to profit by so excellent an example.

The advertisement was as below:

**THE ARCHITECT'S SERVICE
TO HIS CLIENT
INVESTMENT COUNSEL**

An owner's interest in an investment in new buildings or alterations is vitally affected by the requirements and demands of the immediate market of tenants and purchasers. The architect should be able to analyze the demands for immediate accommodation, and advise as to the prospects of immediate return, and advise as to the immediate market. The conclusions of this statement to be anticipated and the special demands of the immediate market. The conclusions of this statement with the previous statement as to fixed and operating charges and the immediate net revenue should be determined. Such study is part of the service of the architect to his client.

This is the Architect's Eighth Duty.
The Ninth Will Appear Next Monday.

REGISTERED ARCHITECTS OF JACKSONVILLE

A. N. COLE	MARK & SHEPHERD
H. C. DOZIER	(V. Earl Mork and L. Shepherd)
MELLEN C. GREELEY	MARK & Saxeby
and ROY A. BENJAMIN	(W. Mulford Mork and H. F. Saxeby)
J. H. W. HAWKINS	JEFFERSON D. POWELL
GEORGE O. HOLMES	W. H. TALLEY
and E. A. EHMANN	JAMES R. WALSH
RUTHLEDGE HOLMES	
H. J. KLUTHO	

their materials and construction, lack the training to express themselves on paper technically, tersely and clearly. Their work is generally either verbose to the extent of confusion or brief to the extreme of inadequacy. It lacks system both in the arrangement of the subjects and in the phraseology.

Such a thing as a permanent "specification model" is not, to my mind, a possibility. But a flexible and comprehensive basis for specification writing can certainly be evolved. In the efforts of this end it is to be hoped that the proposed institute will have the benefit not only of the technically trained mind but also of the mind trained to the proper written expression of technical ideas—that is, the expression in correct, clear and terse English of the ideas it is intended to convey.

GOLDWIN GOLDSMITH.

Lawrence, Kan.

For Art in the Home

San Francisco Chronicle Retains Expert to Teach the People

In an effort to give an impetus to the Better Homes Movement, the San Francisco Chronicle has invited Ross Crane, head of the extension work of the Chicago Art Institute, to conduct a series of lecture demonstrations on the coast.

Architectural Association Elects Officers

The North Carolina Architectural Association held its annual session at Raleigh a short while ago with about 30 members in attendance. Officers elected for the next year are: Harry Barton of Greensboro, president; J. B. Lynch of Wilmington, vice-president; M. E. Boyer of Winston-Salem, secretary and treasurer.

To Help Home Builders

South Dakota Bill Provides Loans at Low Interest

South Dakota home builders will have the privilege of borrowing money from the state to finance their building operations under the provisions of a bill passed recently by the Senate and previously passed by the House.

Loans up to \$4,000, running for twelve years, will be made at a rate of interest not to exceed 1½ per

Specification Institute

An Interesting Letter from Professor Goldsmith

The proposed Specification Institute interests me immensely, not only from my present point of view as a teacher including specifications as one of my subjects, but as having written the specifications for the firm of which I was a member for seventeen years.

In my more recent studies of various specifications I have been impressed by two evident facts. Most of the writers of specifications are dealing with a subject which is irksome to them—and no man can do his best with a task which he does not enjoy. Also, many specification writers who know the technical side of architectural work, who are familiar with

cent. above the rate paid by the state on its borrowings.

The state will obtain money for the loans by the issuance through the rural credits board of \$500 bonds to the extent of \$3,000,000.

McFadden Art Disposal

To Go to Philadelphia If Place Is Provided;
Otherwise Will Come to New York

The art collection of John H. McFadden, cotton broker, said to be one of the most costly and magnificent collections of eighteenth-century English art in the world, is left in trust to the City of Philadelphia under the terms of his will.

The will provides that \$7,500 annually be set aside for the maintenance of the collection, the only stipulation being that the Municipal Art Museum to house the paintings be completed within seven years after Mr. McFadden's death. Should the city fail to meet this requirement, the pictures go to the Metropolitan Museum of Art in New York.

The collection comprises between forty and fifty canvases, one of which is reported to have cost half a million dollars. It includes paintings by Gainsborough, Reynolds, Constable, Raeburn, Romney and other celebrated English artists.

High School Competition

Hartford Architects Invited to Submit Plans

With a decision to erect the new high school, for which an appropriation of \$1,500,000 was made, at the north end site, near Keney Park, the high school plan and building commission has appointed as its professional adviser L. W. Robinson, architect, No. 42 Church Street, New Haven, to act as its adviser in the conduct of the architectural competition and to assist in making the awards. Kirkham & Parlett of Springfield and the Frank Irving Cooper corporation of Boston have accepted the invitation of the commission to submit designs in the competition, according to the program. Those who may wish to take part are requested to apply for admission upon blank forms to be obtained upon application to L. W. Robinson, adviser, high school.

For their services in submitting designs in the competition, a fee of \$750 will be paid, providing that all of the mandatory requirements are met, to each of the two firms named, and to the two Hartford architects whose designs rank highest in merit. No competitor shall be allowed to submit more than one design.

The drawings in the competition must be securely wrapped, addressed to L. W. Robinson, office of the Hartford high school, and delivered by messenger at this address not later than 5 p. m. Saturday, April 30, 1921.

Architectural League Exhibition

The Architectural League of New York will hold its thirty-sixth annual exhibition in the new wing of the Metropolitan Museum of Art from April 1 to May 2. Medals of honor in architecture, painting, sculpture and landscape architecture will be awarded as usual, and a new medal for design and craftsmanship in native industrial art will be awarded this year for the first time by a committee composed of Joseph Breck, Bashford Dean, Barry Faulkner, William Laurel Harris, Henry Kent and A. A. Weinman with J. Monroe Hewlett, president of the League, chairman ex-officio.

Carnegie Institute Exhibit

The Carnegie Institute of Pittsburgh will hold its twentieth annual international exhibition of paintings during May and June. It is reported that the total number of works coming from England and Scotland is to be 10 per cent. larger this year than last, while the French representation will be numerically about the same. Belgium, Italy, Norway and Sweden will all be represented. This year, as heretofore, the international jury of selection and award will be elected by the votes of those contributing to the Institute's International Exhibitions and these votes will come from practically every art-producing country in the world. A gold, silver and bronze medal will be awarded with prizes of \$1,500, \$1,000 and \$500, respectively.

Art Center Getting Settled

The Art Center, Inc., at last has a home of its own. The purchase of two houses at 65 and 67 East 56th St., largely through the generosity of certain leaders in social and artistic life in New York, has made the home possible. The work of transforming these two dwelling houses into a club building for the Art Alliance of America, the Society of Illustrators, the Pictorial Photographers of America and the New York Society of Craftsmen is now under way. As soon as these changes are complete a series of exhibitions will be opened which will be of interest not only to art lovers but to the business world as well. The officers of the Art Center, Inc., are: Mrs. Ripley Hitchcock, president; Charles Dana Gibson, vice-president; Col. Wade H. Hayes, treasurer; Heyworth Campbell, secretary; Walter Ehrich, Ray Greenleaf, Mrs. John Henry Hammond, Chas. E. Pellew, W. Frank Purdy, Henry L. Sparks, Charles B. Upjohn, Clarence H. White, Richard L. Marwede, assistant secretary; Dr. Charles H. Jaeger, chairman, House Committee; and William Laurel Harris, Managing Director.

Painters Hear Lecture on Color Dimensions

Giving color three dimensions, hue, value and chroma, through application of the terminology worked out by Munsell was the subject of a talk before the Rochester Art Club by President Royal B. Farnum, of Mechanics Institute. This system is intended to do away with the present method of arbitrarily giving names to colors, according to the haphazard notions of fashion experts.

The system discussed was invented by Albert H. Munsell, a Boston portrait painter, now dead.

Own Your Home

Exposition in New York Starts April 16 and
Landscape Gardeners Co-operate

Representatives of the landscape gardening and floracultural industries have agreed on a program of cooperation that will provide a unique character to the coming "Own Your Home" Exposition to be held in the 22nd Regiment Armory in New York, April 16 to 30, by developing sample landscape and scenic effects within the show.

Model homes of brick, frame and concrete, erected from the prize-winning plans of the "Small House Competition," conducted under the approval of the American Institute of Architects for several months prior to the Exposition, will be completely furnished and decorated, as exhibits. Realizing the importance of the landscape treatment of the home site, it is planned to surround these model houses with the best efforts of landscape gardeners. The walls of the old Armory will be transformed by a panoramic scene; towns, villages, lakes, rivers and woodlands, tiny farms, colorful orchards and sweeping meadows will give the effect of a lovely suburb setting, an ideal setting for an ideal home.

The floor area will be divided by two main avenues along which sentinel cedars connected by evergreen hedges will lead to the center fountain, banked by dwarf pines and beds of brilliant roses and early spring bulbs. The four corners of the court will be treated as individual compositions—one natural in character, will disclose a tiny fairyland of rhododendrons, azaleas, ferns and lilies, half hiding a rock pool in which red maple, swamp cedar, dogwood and red bud will cast their reflections, and on one side of which, under a gnarled cedar, is a woodland seat covered with golden bell and sweet syringa.

Another corner, in marked contrast, will show the effect of architecture on a woodsey scene. Clipped hemlock on a straight grass panel will form a niche in which stands a piece of garden sculpture. A third corner will be devoted to evergreens, massed pine,

hemlock, cedar and rhododendrons with sprays of white dogwood will back a stone seat and dwarf evergreens will add to the attractiveness of this composition.

It is expected that the landscape treatment by the nurseries, seedmen, florists, manufacturers of garden furniture and sculpture, tree surgeons and all the trades which contribute to the development of the home grounds will prove an incentive to the general public to build and beautify.

Additions to Museum

Metropolitan Shows Architectural Subjects

The pediment from the Madison Square Presbyterian Church has been erected on the Museum Library together with two pierced terra cotta medallions also formerly in that church. The Louis XVI shop front, which originally stood at No. 3 Quai Bourbon, Paris, may now be seen in the Morgan wing. And finally, the plaster model of the Roman Forum has been set up in the Gallery of Casts next to the model of the Pantheon.

Famous St. Lazare Prison Is to Be Demolished

Institution Associated With Some of Stirring Periods
in French History

The famous prison of Saint Lazare, the penal institution for women situated in the heart of Paris, whose tragic and sinister history dates from the eleventh century, is to be demolished by the French government.

The ancient prison, harboring within its dark and sombre embrace the most dreary dungeons in the world, has outgrown its usefulness and will be entirely destroyed.

With its demolition will go an institution intimately connected with some of the most exciting moments of French history.

New York Rent Laws Upheld

On March 8 the constitutionality of the rent laws passed at the extraordinary session of the New York State Legislature were upheld by that State's Court of Appeals in a most sweeping decision.

The laws were passed primarily as an "emergency" measure, designed to protect tenants from exorbitant rents by vesting the judiciary with rent adjusting and fixing power, upon due hearing and process of law. The laws also carried certain clauses having to do with eviction of tenants who could not pay the increased rent asked by a landlord, desired to move, yet could not move because of lack of housing

THE AMERICAN ARCHITECT

facilities. In such cases the law directed an appeal to the judiciary, whose decision was binding.

The four principal constitutional objections to the laws on the part of the landlords were: First, that they denied to the landlords the equal protection of the laws; second, that they deprived the landlords of property without due process of law; third, that they interfered with freedom of contract; fourth, that they impaired the obligation of contracts.

The conclusion of the decision was as follows:

"The conclusion is, in the light of present theories of the police power, that the State may regulate a business, however honest in itself, if it is or may become an instrument of widespread oppression; that the business of renting homes in the City of New York is eminently such an instrument and has therefore become subject to control by the public for the common good; that the regulation of rents and the suspension of possessory remedies so far tend to accomplish the purpose as to supervene the constitutional inhibitions relied upon to defeat the laws before us."

It is estimated that fully 100,000 tenants who were facing eviction warrants when the law became effective last September are now safe against eviction as long as they pay a fair and reasonable rent.

Efficiency Body Favors World Fair in 1926

An international exposition in 1926, the 150th anniversary of the Declaration of Independence, to be called the World's Exposition of Peace and Democracy, was proposed at the ninth annual session of the National Efficiency Society in the Hotel Astor, New York.

The exposition would attempt to trace the progress in economic, industrial and political fields that has taken place since the Centennial Exposition.

The society proposes that only those concerns be

permitted to participate who could show at least three years of co-operative relations between employer, employe and the public. It is suggested that the exposition be conducted either in Washington, or in conjunction with the general exposition in Philadelphia.

Architectural Society Elects Officers

The Reading (Pa.) Architectural Society elected the following officers at a recent meeting: President, Charles H. Muhlenberg; vice president, Claude B. Mengel; secretary-treasurer, Harry Maurer; directors, Miles M. Dechant and Raymond J. Richardson.

An active part will be taken in solving any problems for the advancement of architecture in the community. Lectures, exhibitions and the discussion of public improvements will occupy the attention of the members at their monthly meetings.

Personals

Martin J. Garry and Robert A. Sheffey, is the name of the architectural firm formerly known as Martin J. Garry. Offices are located in the K. & M. Building, Bluefield, W. Va.

Richard E. Grant, landscape architect, formerly of 1007 Mercantile Library Building, Cincinnati, O., has moved to 502 St. Paul Building.

Herbert A. Kennison, architect, formerly located at 746 Builders' Exchange, Minneapolis, Minn., has moved to larger quarters at 411 Plymouth Building, that city.

Frank X. Tewes, architect, formerly associated with G. L. Lockhart, St. Paul, Minn., has opened an office for the practice of architecture at 313 Guardian Life Building.

Weekly Review of the Construction Field

With Reports of Special Correspondents in Regional Centers

The Philadelphia Plan

A Communication from the Council of Associated Building Trades to the Trades Relations and Policy Committee, Master Builders' Exchange, Philadelphia

The signing of the various agreements in the building industry is only one detail. Under present methods that is up to the individual trades and their respective employers subject to the approval of the Council of the Associated Building Trades. Good progress is being made.

But the question of rate of wages per hour is not the vital matter. Your committee, as we understand it, is to recommend constructive steps leading to a permanent stabilization of the industry as well as an immediate revival of building.

The public expects lower building costs and honest building. Builders and building trades must rise to the occasion and put their industry on an efficient basis which will induce an immediate resumption of building, so vitally needed in our city. We must all put our shoulders to the wheel.

The first step is to squeeze the water out of 1920 peak costs. Let us begin to do so along the co-operative lines suggested in our "Philadelphia Plan" presented last September to the Industrial Relations Committee of the Chamber of Commerce.

Builders at the Philadelphia Chamber of Commerce conferences in February made a point that "building costs" for 1921 should be decreased from the 1920 peak of 250 per cent. of 1914 prices to approximately 150 per cent. Or in other words, a building which cost \$25,000 last year and \$10,000 in 1914 should cost this year around \$15,000 to \$16,000.

That is our goal. We must encourage greater efficiency in management and cut out the labor waste.

There must be a fair wage for employer and wage-earner alike. Honest work must be done. We are ready to do a fair day's work for a fair day's pay. We must all work efficiently.

By greater productivity per man we may help to bring the unit costs down even lower than 50 per cent. above 1914. We are ready to carry on such a plan.

The employers should also work out some plan of eliminating the intermittent employment. So long as most building trades must figure so many working days lost per year, the compensation per hour on days actually worked must be higher than is paid by other industries.

So far, we have no assurance that 1921 will be any different in this respect. Let the Proposed "Philadelphia Plan" Committees, with unbiased manage-

ment, engineering advice, study conditions, develop better methods of doing the work, eliminate waste and unnecessary costs, and take some constructive steps towards steady year round employment. The trades will gladly figure lower rates per hour if we can see, how we are going to meet our bills, educate our children, get a little pleasure out of life, and lay something by for our later years, as emphasized by Chairman Trigg. The buyer of our product cares only for the final cost and workmanship, and that his job be done within a reasonable time. It is up to us to restore his confidence in us, by stabilizing our business and causing prices which will attract new building.

Just think over what the loss of real working days mean on a building job. Days which men in continuous employment earn money. Everyone knows that regular full-time pay envelopes mean satisfied workers. A man spends more loafing than when he is WORKING. Most building trades lose from 75 to 100 working days a year. It is our duty, both employer and employee, to eliminate some of the causes of this wasted time.

If we are to secure the earnest co-operation and sincere effort for efficiency among all workers in the trades let us not reduce our present rates at this time. We cannot afford to take the heart out of men or drive them out of the industry by a wage cut when greater results and savings in total costs are possible if we all jump into the harness and pull together. Wages should not be disturbed until things are well started and conditions and engineering reports determine at what hourly rates the "Trigg standard of living" can be maintained.

Our industry has never marketed its service and workmanship along modern merchandising lines. It is up to the industry as a whole to come forth with a constructive selling program and educate the buyer and worker to the best construction, working conditions and safety to the public. Think of the romance of our business. Our men working high in the air juggling heavy materials and how seldom an accident to the public has occurred through carelessness. Many accidents to the worker have happened because of failure of employers to provide proper safeguards or scaffolds for them. Let us have a real "safety first" movement on our work, no more "penny wise pound foolish" policy when life and limb are at stake. Let the joint conferences of those actually interested in our "Philadelphia Plan" get busy. There are so many things to be done.

A sound practical program must be worked out to

provide for greater activity and demand for our product. Build up the off peak business, the retail end needs intensive developing, the service part, too, has been untouched. After we finish the erection of the monument—time, weather and unforeseen causes hasten depreciation—let us not wait until it falls down and they come to look us up before we recommend maintenance and repair work.

Our industry does not come out with scare headlines every time they raise the price of gasoline—yet they are ranting around in the press and elsewhere along with others about high cost of building and won't build. They are biting the hand that feeds them. If they boost our industry, it creates a greater demand for their products all along the line. Yet we sit by and let them tell others in our city not to build.

In summary, the main point that we wish to make is this, that there is a great area of common interest between the employer and the employee through the reduction of the great waste of voluntary and involuntary unemployment, and in the increase of production. If we are to secure increased production

and an increased standard of living, we must keep awake interest in creation, in craftsmanship, and the contribution of the worker's intelligence to management. Battle and destruction are a poor solution to this problem. The growing strength of national organizations on both sides should not be and must not be contemplated as an alignment for battle. Battle quickly loses its rules of sportsmanship and adopts the rules of barbarism. These organizations—if our society is to go forward instead of backward—should be considered as the fortunate development of influential groups through which skill and mutual consideration can be assembled for co-operation to the solution of these questions. If we could secure such co-operation, throughout all our economic groups, we should have provided a new economic system, based neither on the capitalism of Adam Smith nor upon the socialism of Karl Marx. We should have provided a third alternative that preserves individual initiative, that stimulates it through protection from denomination. We should have given a priceless gift to the twentieth century.

The Building Situation on the Pacific Coast

(Special Correspondence to THE AMERICAN ARCHITECT)

SEATTLE.—The unsettlement of the construction labor market is holding back what would be a fair interest in building projects on the Pacific Coast. Investors, architects and contractors are almost a unit in the statement that it will be impossible to pay carpenters \$6.40 per day for eight hours, the figure nominally settled upon, and do any business this season. Jobbers are endeavoring to induce cement manufacturers to cut on their product, which is the only one now moving owing to the extensive hard-finished road building program and construction on the Pacific Coast.

Jobbers declare there is no further necessity of holding building materials at theoretical levels. Losses must be taken as gracefully as possible with replacement costs and efforts made to rouse investors.

Steel continues to show signs of weakness. Outside mills have quoted lower this week on sheets. There is a general inclination to take losses on these materials in order to hasten reconstruction, and jobbers can get concessions from the independent mills on desirable orders. Corporation prices are holding steady. Stocks are ample.

The pipe market is steady. All the jobbing houses on the coast are stocked up, and there is even a surplus of good working stock. There is no difficulty now in getting prompt acceptance and delivery even of the halves and three-quarters. The nail supply,

scanty last winter, is plentiful. In practically every line jobbers have a sufficient supply on hand to meet any demand for the half year.

There is a demand for carpenters at \$4 per day as against \$6.40 and builders say they can see some light ahead on that basis. Should the wage scale remain as tentatively agreed upon at 25 per cent. under last year's level, it is believed that there will be no special building activity on the coast this year. The undertone is weak today, and there is more than a faint hope that an early adjustment will be made.

Lime is weak, and jobbers will be able in a few days to announce a decline. Cement manufacturers have stood against recessions, and say positively there will be no reduction this season. Eastern roofing can be laid down f. o. b. warehouses Seattle cheaper than North Coast manufacturers are quoting. There have been some recent reductions in channel iron.

Steel is working toward bottom. Fir lumber has evidently reached that point, for there have been no weaknesses excepting in spots of common dimension in 30 days. Water rates to the Atlantic seaboard are falling, and the new lower rail rates that will re-establish the parities with southern pine as far east as Pittsburgh, will go into effect April 1. The transportation problem, which menaced the fir lumber industry last August when the new emergency freight rates went into effect, will be sufficiently reduced to enable West Coast manufacturers to re-enter the

heavy consuming districts of the East, is near solution. Intercostal shipping lines have given evidence of a willingness to further reduce the water rates to New York, and eastern buyers have accordingly shown considerable interest in the outlook. On this basis, also, red cedar shingles have begun to move into New York and the entire New England territory, and their favorite brand is the perfection 18-inch shingle, which is selling to the trade here

this week at \$3 to \$3.05 per square of four bundles.

Average prices at which leading building sizes sold at the fir mills for the eastern trade during the week were as follows: No. 2 and better vertical grain flooring, \$45; No. 3, \$23; five-eighths by four No. 2 and better ceiling, \$20; with \$12.50 for No. 3; drop siding, \$21; boards and shiplap, \$12.50 to \$13.50; dimension, \$11.50; plank and small timbers, \$16.50, and large timbers, \$52 to \$56.

Building Conditions in Chicago and the Middle West

(Special Correspondence to THE AMERICAN ARCHITECT)

CHICAGO.—There is no lack of developments in the Chicago building situation these days. If it becomes quiet in one sector, it is very apt to break out in another quarter and thus force itself upon the public interest. The bulge this week affects the matter of high rentals and the efforts of the tenantry to overcome the increases by legislation, which has as its aim, a paternal supervision by the state or city. The Kessinger bill, now pending in the state legislature, would provide that the subject of fair and unfair rentals be left to a commission to be appointed under state statute which would be effective over a period of emergency, to last not longer than 1925.

That there is considerable public interest in the measure is indicated by the fact that a special train bearing more or less irate tenants went to Springfield, so that the cause of the flat-dweller might be presented with due force and effect. The papers, naturally, have been full of the fight now waging between landlord and tenant, but thus far nothing definite has come of the struggle.

Agitations of one kind or another have succeeded each other with faithful regularity, but it is now becoming dinned into the hearts and minds of the Chicago public that there is only one way out of the housing difficulty with its ensuing high rentals and that is by the path of greatly increased building activity.

Although this fact is becoming generally understood and remarked upon, the actual efforts in the direction of more building have been limited. Here and there are to be found sporadic attempts to meet the situation, but building, in general, is not taking on the spirit of activity that was fondly hoped might have been fairly manifest by this time. The trend, however, is in the direction of home building and gradual gains are being made.

As heretofore mentioned in these reviews, the

Lumbermen's Association is planning an object lesson in building. S. F. D. Meffley, secretary and manager of the Association, is going to arrange for the construction of a six room house for \$6,000. By co-operative effort of architects, lumbermen, builders, union labor and painters and decorators, the house is to be put up in a hurry. Two days is the outside limit for its construction and considerable publicity, via films and newspapers, is to be given the effort. The reason back of it all is to show that costs of construction are not prohibitive, which thought seems to be pretty well established in the minds of prospective builders of bungalows and small houses.

Inasmuch as it seems rather certain that much of the early building will concern residential properties, interest has centered in the effort of the carpenter's union and the lumber interests to have building restrictions so modified that frame buildings may be erected in districts formerly sacred to brick structures only. A measure to make the restrictions less rigid is now pending before the city council and is meeting with considerable opposition, some of which is coming from the architects of the city. The architects aver that any removal of present building regulations would increase the fire risk very greatly and let down the bars to a great deal of unsafe and unsatisfactory construction. A very wordy battle ensued at a council committee hearing on the subject, brick manufacturers and the lumber interests being opposed in the argument. At this time, no decision has been reached as to the final outcome of the agitation.

The argument often advanced just now that materials must come lower before building can be started on a broad scale lends special interest to approaching conventions in which the element of construction cost will unquestionably be given attention. The National Wholesale Lumber Dealers' Association will hold its twenty-ninth annual meeting here,

THE AMERICAN ARCHITECT

March 29-30, with five hundred wholesalers in attendance. Right on the heels of this meeting will come the nineteenth annual convention of the National Lumber Manufacturers' Association, with lumber producers from all over the country in attendance. The lumber interests maintain that lumber has already taken all of the sag out of prices and that there can be no further reductions, nevertheless, the conferences may be expected to rivet public interest on building and out of it all will come a further stimulus to building—this, at any rate, is the argument advanced by local optimists.

As in previous weeks, the chief center of activity in local building is to be found in the outlying suburbs. River Forest is one of the latest suburbs to report consistent building gains. Twenty-seven houses, representing a total improvement of \$750,000, are shortly to be under way, in addition to much additional home building in that suburb. Practically all construction is of the better sort, the cost of the residences ranging between \$25,000 and \$50,000, and all furnishing employment for architects.

Practically all the money needed to finance the construction of apartment house buildings, to cost \$200,000 and upward, is promised Chicago builders at 6 per cent. and an underwriting charge that will cover the expense of distribution without profit, by S. W. Straus & Co. The suggestion is made that loaning institutions in Chicago similarly act in a movement to cut out the big commissions at present charged in connection with high interest rates.

Winnetka and Glen Ellyn are other suburbs in which building is in progress. Twenty houses are in course of construction in the former suburb. Labor is plentiful in the suburbs, and cost of construction is down to a point where construction is profitable on an investment basis.

Building permits continue to hold their gains. The March record will be very much ahead of the total for March, 1920, and considerably ahead of the February, 1921, total.

Chiefly interesting among the larger proposed

structures is an invitation from The Co-operative Society of America to engineers and architects to submit rough sketches, on their own responsibility, for a \$3,000,000 warehouse, to be built by the Society. It is said that a large number of architects are figuring on the proposed building.

Prices in both the materials and lumber lists are practically at old levels. Strength is being shown in some materials and it is believed that any important gain in building will lead to a rapid readjustment of values, particularly in lumber.

Present quotations range as follows:

Yellow Pine: B. & B. 1-in., \$95 to \$130, depending on thickness; 2 x 4, No. 1, 10 to 16 ft. length, \$51 to \$53; 2 x 6, \$48; 2 x 8, \$50; 2 x 10, \$53; 2 x 12, \$55; 13-16 x 3¼ z & b flat flooring, \$85 to \$90; 1 x 6, No. 2 common, \$48 to \$90. *Douglas Fir*: 2 4 S, in sizes up to 12 x 12, in length up to 32 ft., \$65 to \$70; 14 x 14, \$68 to \$73; 16 x 16, \$72 to \$75; 18 x 18, \$75 to \$80. *Hard Maple*: Four, ¼ No. 1 and 2, \$135; select, \$120; No. 1 common, \$100; No. 2 common, \$65; No. 3 common, \$32. *Birch*: Four ¼ No. 1 and 2, \$160; select, \$133 to \$138; No. 1 common, \$95 to \$100; No. 2 common, \$60 to \$65; No. 3 common, \$40. *Red Gum*: Four ¼ No. 1 and 2, \$150; No. 1 common, \$90 to \$92; No. 2 common, \$45.

Face Brick—Standard, vitrified red, \$32.00@34.00; Smooth, Indiana red, \$38.00@40; Smooth, Ohio red, \$38.00@40.00; Smooth, Pennsylvania red, \$46.00@48.00; Smooth, buff, \$45.00@47.00; Smooth, gray, \$47.00@49.00; Rough, buff, \$44.00@46.00; Rough, gray, \$47.00@49.00; Variegated, rough texture, \$34.00@49.00.

Common brick, \$13.00 to \$16.00 per M. Portland cement, \$2.25 per bbl. Torpedo—Lake and bank sand, \$3.50 per yd. Crushed stone, gravel screenings, \$3.50 per yd. Hydrated lime, Ohio, paper, \$21.00 per ton. Hydrated lime, Ohio, cloth, \$29.00 per ton. (Includes sacks at 30c each.) Hydrated lime, Wis. paper, \$19.00 per ton. Bulk lime, \$1.65 per ton.

front piece 8 1/2 2362.

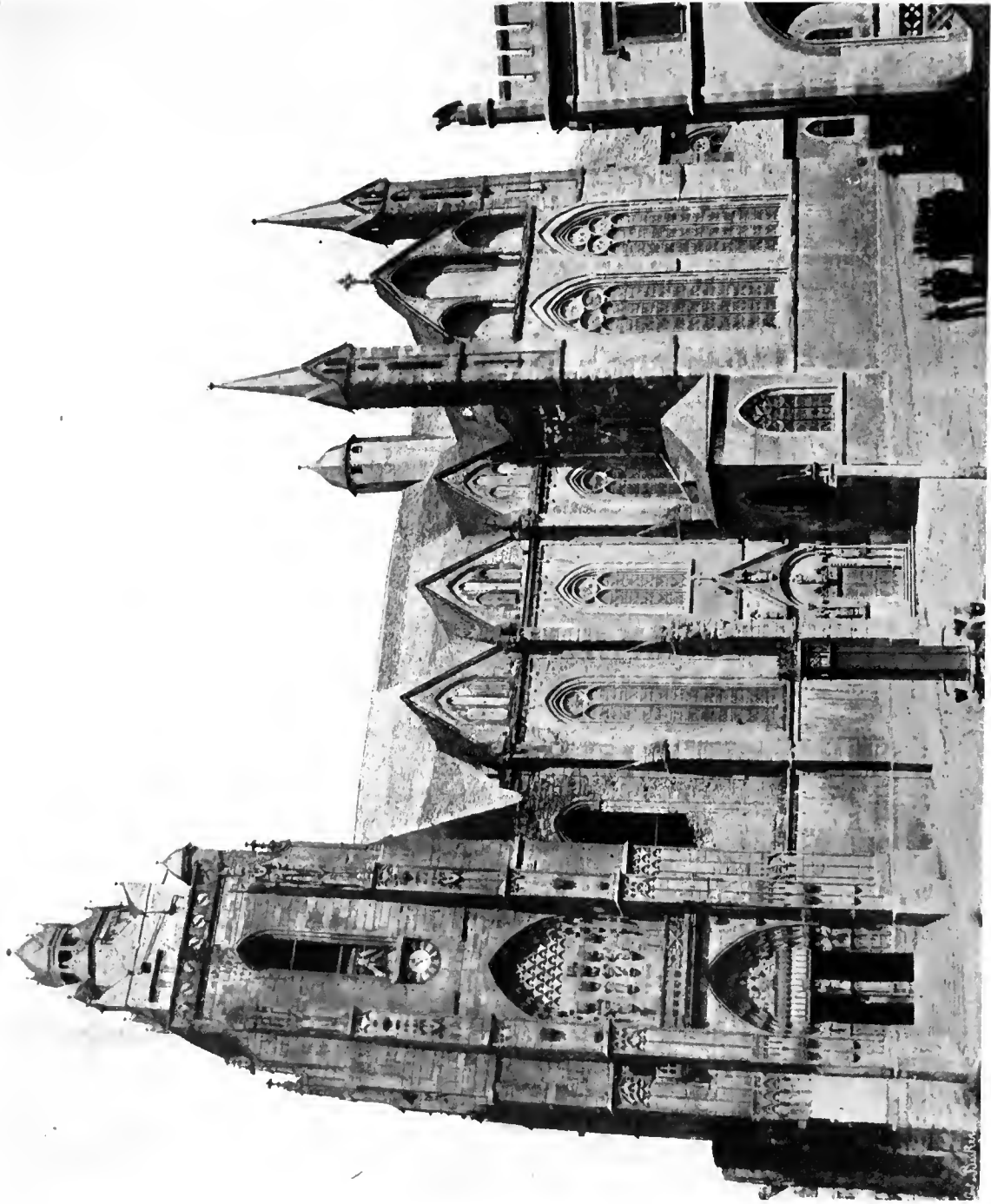

THE CATHEDRAL, WETZLAR, GERMANY.

THE AMERICAN ARCHITECT.

THE AMERICAN ARCHITECT

VOL. CXIX

WEDNESDAY, MARCH 30, 1921

NUMBER 2362

Hotel Webster, Chicago

FRIDSTEIN & COMPANY, *Engineers*

AMONG the more important hotel buildings constructed in this country during the year 1920 is the Hotel Webster at Chicago. Even in years more favorable to building construction with a greater volume of work done, this building would be well worthy of attention. Notwithstanding the unsettled labor conditions and high cost of materials and labor, and at times a scarcity of both, this building was erected complete at a cost of 60 cents per cubic foot for materials and labor, not including commissions and carrying charges. This was made possible through careful designing and the thorough and complete preparation of the plans and specifications. Withall, the quality and kind of the materials used in its construction is of as high grade as was used in any similar building erected at that time.

The building is located on the southwest corner of Webster Avenue and Lincoln Parkway, west, faces Lincoln Park and is but a short distance from Lake Michigan. The surroundings and the outlook from the building are as attractive as any location in that city. The structure is fifteen stories high above grade, with a basement story. The building fronts 120 ft. on Lincoln Parkway west, and 128 ft. on Webster Avenue.

The exterior is designed in Italian Renaissance style. A pink granite base about 4 ft. high is on the two street fronts above which the walls are finished in terra cotta to the fourth floor line. The spandrels of the end halls are made of terra cotta panels and the walls from the fourteenth floor line to the top are faced with the same material. The texture of the terra cotta is rough, of soft grey color with slight shade of pink. The balance of the walls is faced with brick with terra cotta window sills and caps.

The details are refined but always sufficiently bold for their location. The building has a structural steel frame with combination hollow tile and concrete floor construction. The foundations are concrete caissons from 4 ft. to 6 ft. in diameter with enlarged bottoms, where they rest on a layer of hard pan about 20 ft. thick. Hardpan in this locality is

about 45 ft. below datum and about 62 ft. below the average grade of the ground. Rock in this locality is 95 ft. below datum. The caissons were of the open well type and practically dry throughout their entire depth.

The main entrance is on Lincoln Parkway west, an entrance from Webster Avenue gives access to the dining room and the service entrance are on the alley. The main entrance vestibule is designed in early Italian Renaissance with the Moorish influence which was prevalent at that time. The walls are finished in marble and terra cotta and the ceiling ornamented with heavy plaster relief work, finished in vivid colors. The lobby is 68 ft. by 65 ft. in size with a skylight over about one-half of its area. This is designed in a later Italian period. The colors are soft and light, using the old Venetian blues, yellows and reds. The ornament is characteristic of this period with a slight influence of French. Adjoining the lobby, on the east, is the ladies' parlor and retiring room. The offices and newsstand are on the south of the lobby.

THE INTERIOR TREATMENT

The dining room occupies about one-fourth of the first floor in the northeast corner of the building, and is four steps above the level of the lobby. This room is designed in an English Colonial style with an influence of Heppelwhite, the ornamentation being very delicate, paneled columns, soffits and ceilings. The scheme of color is an old ivory white, relieved in very delicate tones of different shades of blue, with very little other color being used. The same scheme is carried out in the musicians' gallery and ladies' writing room on the mezzanine floor, both overlooking the dining room. The kitchen adjoins the dining room and covers a little less than one-third the total floor area. The completeness and convenience of the layout is indicated by the plan. Receiving and service rooms occupy about one-eighth of the floor area in the southwest corner.

A mezzanine floor over the kitchen, receiving and service rooms, contains the ladies' writing room,

THE AMERICAN ARCHITECT

musicians' gallery, card room, tea room, barber shop, maids' and children's dining room.

The basement contains the boiler and fuel rooms, pump and refrigerating rooms, storage, toilet and locker rooms for the employees. Steam is used for heating the kitchen and hot water service. The machinery is operated by electric power furnished from the outside.

The typical room floors each contain 20 bedrooms

the top floor is located the hall room 45 ft. by 75 ft. in size. Adjoining the hall room is a service room, storage room, check and retiring rooms for both men and women. This floor also contains a trunk storage room, valet department, linen room and other service facilities.

ELEVATOR EQUIPMENT

The building is served by three high-speed passenger elevators, one of which serves the basement ;

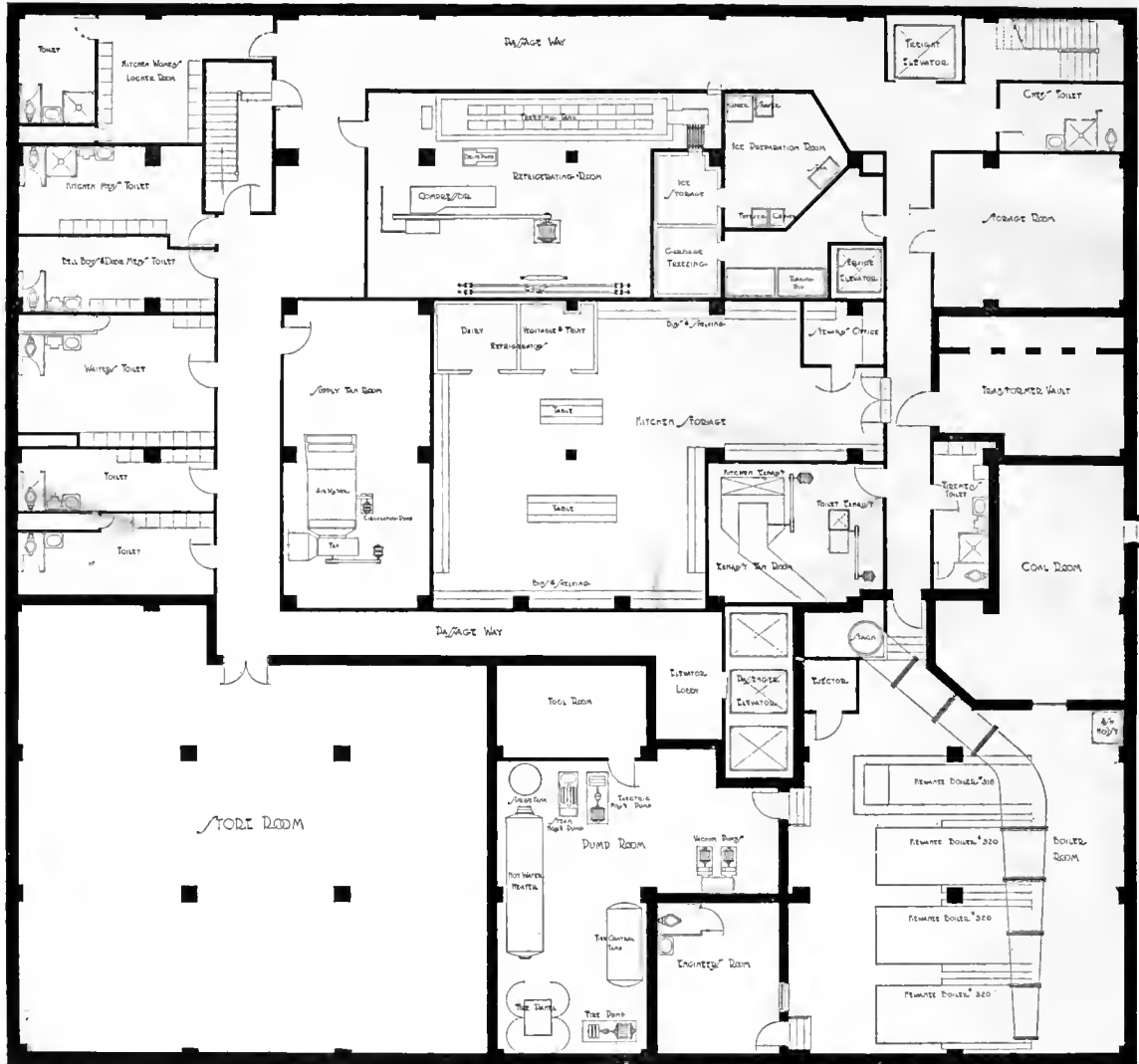

BASEMENT PLAN

with bath and large clothes closet and 10 living rooms with large closet opening into the entrance vestibule. The plan is so arranged that a number of bedrooms can be used in connection with a living room. The living rooms average 18 ft. by 20 ft. in size and the bedrooms 15 ft. by 18 ft. Two enclosed stairways and two fire escapes serve as means of egress. On

a freight elevator traveling from basement to top story, and a service elevator from first floor to all upper floors. This service elevator is used for room service only. In the installation of these elevators an unusual combination of motors was made and the working results have been most satisfactory. In the electrical equipment of these elevators, advantage



DINING ROOM



LOBBY
HOTEL WEBSTER, CHICAGO.
FRIDSTEIN & CO., ENGINEERS

THE AMERICAN ARCHITECT

was taken of the fact that an induction motor driven above its synchronous speed acts as an induction generator and furnishes power to the line to which it is connected, when driven at such over speed. Advantage has been taken of this characteristic in facilitating smooth and efficient operation of high speed elevators.

line, with proper resistance inserted in the circuit of the slip ring motor, and also, in order to limit the torque, the current inrush, and to increase the slip, resistance is connected in series with the main leads of the squirrel cage motor. As the set speeds up, the squirrel cage motor is disconnected from the line when the set is operating at a speed of approxi-

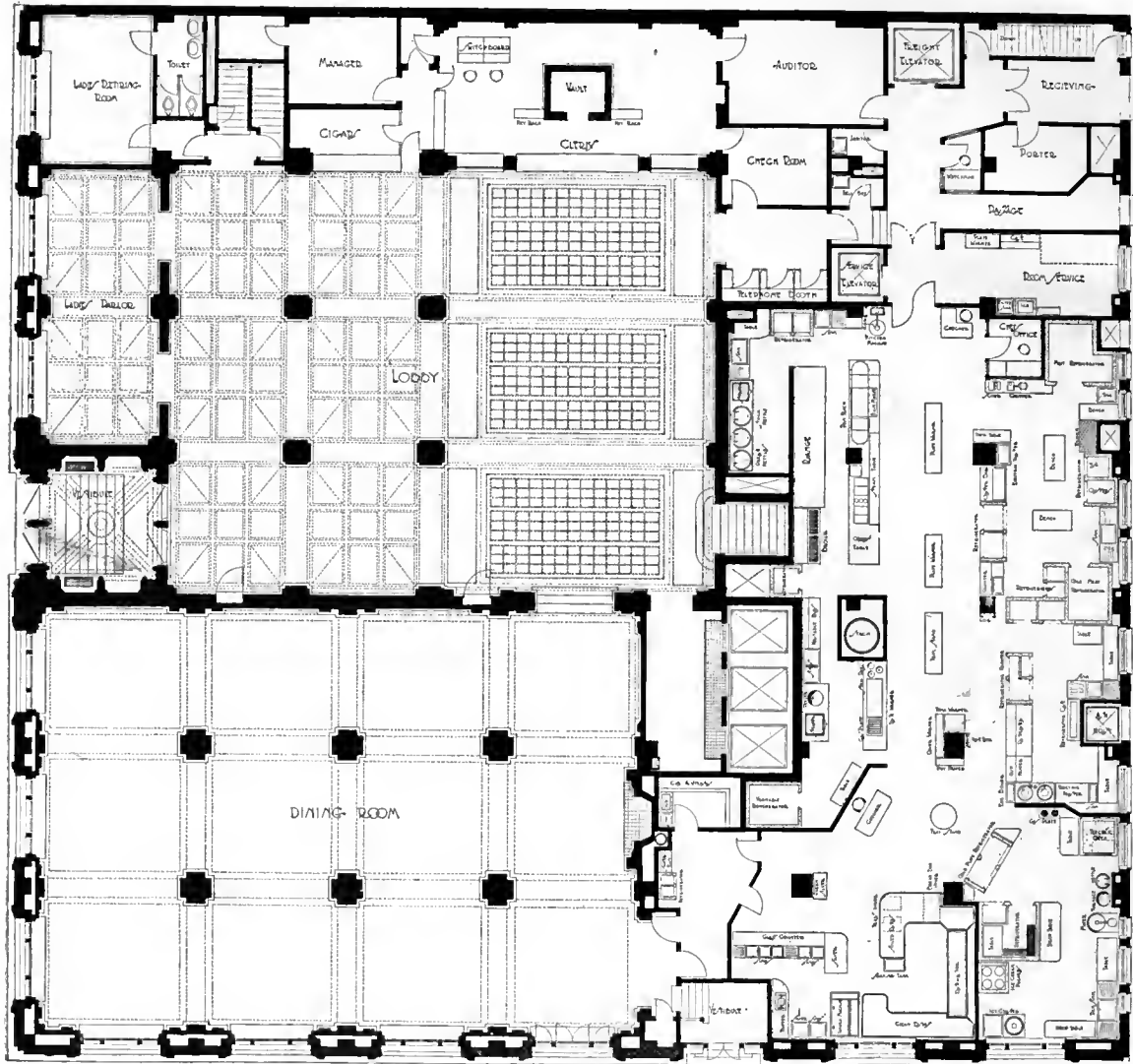

MAIN FLOOR PLAN

Such motor equipment consists of two induction motors, either rigidly coupled together or having both motors mounted on the same shaft. The main driving motor is of the slip ring type, variable speed, and the second motor is of the high resistance motor squirrel cage type. The horsepower ratings and speeds of the two motors are determined by the application. In starting, after the brakes are released, the automatic control connects both motors to the

mainly the synchronous r. p. m. of the squirrel cage motor. At the same time, in a series of steps, the balance of the secondary resistance is cut out in the motor circuit of the slip ring motor, thus allowing the elevator to travel at the desired high speed.

When stopping, the reverse operation takes place; the whole amount of the secondary resistance is inserted in the circuit of the slip ring motor and the squirrel cage motor is again connected with the line



LOBBY, LOOKING SOUTH



DINING ROOM, LOOKING EAST
HOTEL WEBSTER, CHICAGO, ILL.
FRIDSTEIN & CO., ENGINEERS

THE AMERICAN ARCHITECT

at which time it acts as an induction generator, transferring some of the kinetic energy of the elevator back into electrical energy, which in turn tends to slow down the set until the same has obtained a speed corresponding to the synchronous r. p. m. of the squirrel cage motor. The next operation disconnects both motors from the line and applies first one and then the other brakes.

A recently invented indicator is also installed in each of the passenger elevators. The floor push button signals indicate by the usual red or white lights opposite the floor number. On the same frame is installed two dials on which each floor number is indicated. A single hand or pointer moves as the

corresponding other elevator car travels and indicates its exact location. The operator in one car can locate each of the other cars and its direction of travel. Any number of dials can be installed in each car to correspond with the number of elevators in the battery. Where elevator starters are not employed and especially for the intermittent service characteristic of apartment hotels, these indicators save in car travel by indicating to each operator which car had best serve the floor call.

Every feature of construction and equipment that would lessen the maintenance and operation costs has been incorporated in this building. The building was erected by G. H. Gottschalk & Company.

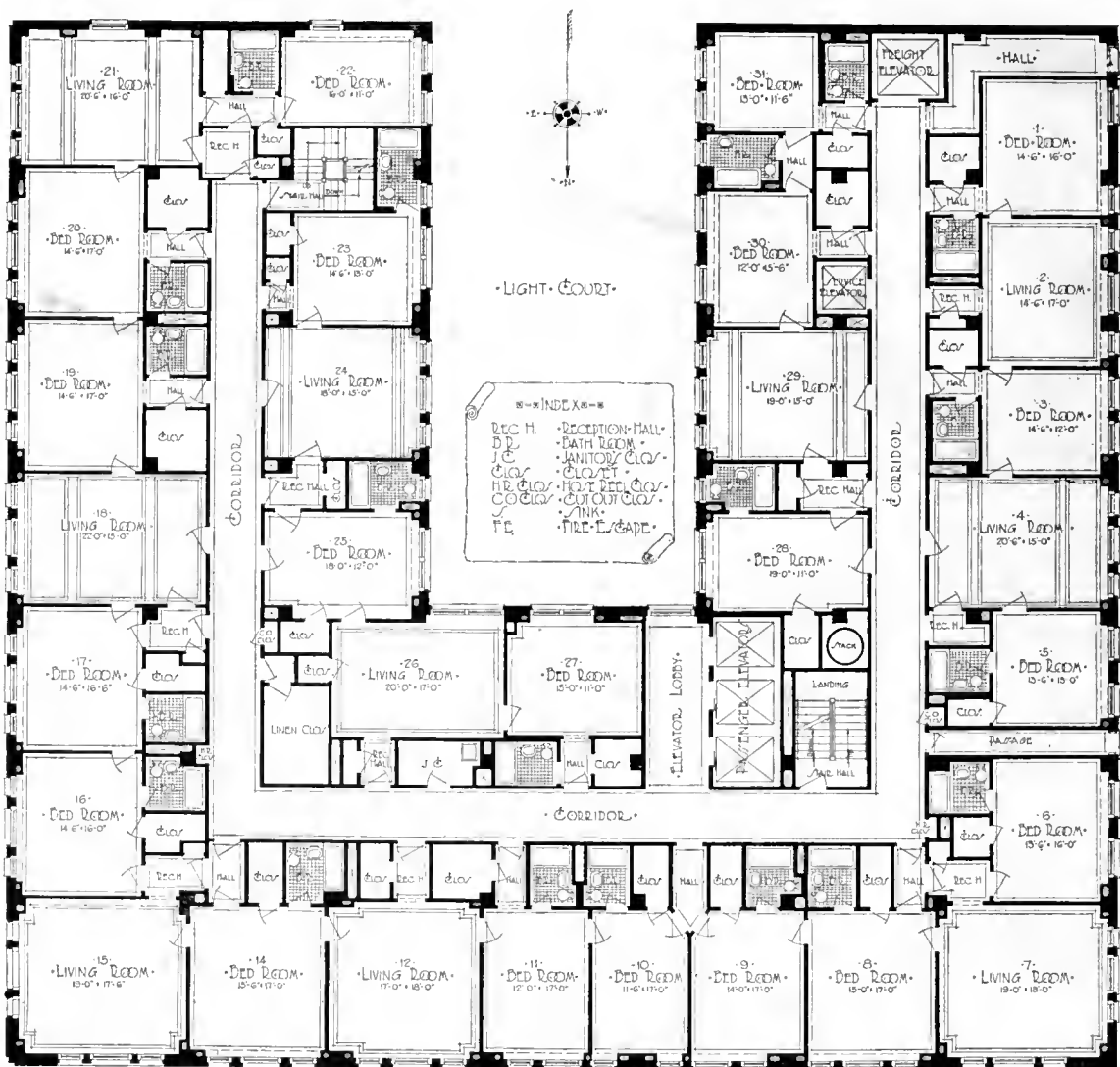

TYPICAL FLOOR PLAN



STORE BUILDING FOR PENNELL, GIBBS & QUIRING CO., BOSTON, MASS.
H. B. PENNELL, ARCHITECT

Architectural Quicksands

By CLINTON H. BLAKE, JR., of the *New York and Federal Bars*

THE preparation and adoption by the profession and by the various Master Builders' associations of the Standard Documents of the American Institute of Architects marked a great advance along the line of placing the dealings of the architect, owner and contractor on a definite and, so far as possible, standardized basis. The standard form of agreement between the contractor and the owner is admirable in many ways. It manifestly cannot be employed, in every case, without alteration, and the architect must use proper discretion in adapting it to the needs of the work in hand. There are various provisions in the standard form which the architect should consider with more than special care, and a word concerning these may be in order.

In referring to the agreement between the contractor and owner I have reference, of course, to the complete agreement, viz., the agreement proper and the general conditions, specifications and drawings as well.

Article 3 of the form of agreement proper, as distinguished from the general conditions, provides that the agreement, on the part of the owner to pay the contractor, is subject to "additions and deductions as provided in the general conditions." The wording of the above phrase might with advantage, it seems to me, be made somewhat broader. The agreement of the owner is subject not only to these conditions and deductions, but is subject, and should rightly in every case be subject, to the performance by the contractor of all the substantial conditions specified. It would seem that it would be advisable, therefore, especially if there be any question of the standing of the contractor employed, to amplify the phrase quoted so as to read, in substance, that the agreement of the owner to pay is "subject to the conditions and deductions provided in, and to the performance by the contractor of all of the terms of, the general conditions of the contract."

Coming now to the general conditions of the contract proper, sub-division k of Article I provides that the law of the place of building shall govern the construction of the contract, and by Article 45 the same plan is adopted, with respect to the arbitration scheme provided for, and it is specified that the arbitration procedure shall conform to the laws of the state in which the work lies. In many cases, especially where the owner and the contractor are residents of the same state and where the work is done within that state, there would be no objection to the clause as set forth in the general conditions. If the work is to be

done, however, in some other state the owner and the architect, and for that matter the builder as well, should give careful consideration to the matter before agreeing that the laws of a different state shall govern their dealings and determine their obligations. They should at the least, before entering into any such agreement, find out just what these laws may be, how broad they may be with respect to liens and the like, and how they may affect the dealings of the parties.

In Article 5, relating to shop drawings, it is provided that the approval by the architect "shall not relieve the contractor from responsibility for deviations from drawings or specifications unless he has in writing called the architect's attention to such deviations at the time of submission." This provision is dangerous in the sense that the implication from it clearly is that, if the contractor has called the architect's attention to deviations from the drawings and specifications, the contractor will not be responsible therefor. We have already seen that the architect, in the absence of special authority, has not power to authorize any changes in the plans or specifications or any deviations from the work as therein set forth and laid out.

Article 24 of the Standard Documents, it is true, provides that no change (other than as provided in Articles 9 and 18) shall be made, unless in pursuance of a written order from the owner, signed or countersigned by the architect, and that no claim for an extra over the contract amount shall be valid unless so ordered. This provision is quite in line with the legal rule to which I have above referred. It is in line, also, with the various cases which have already been discussed in the earlier articles of this series, to the effect that the owner cannot be bound by changes in the plans and specifications authorized by the architect, but not approved or authorized by the owner.

It would be well it seems to me, if the wording of Article 5 were so altered, therefore, as to avoid any misleading interpretation thereof, either on the part of the contractor or on the part of the owner. The owner and contractor have, of course, the right to provide, by the terms of the contract, that the architect may make such changes and authorize such deviations from the drawings and specifications. The general legal rule quoted would not apply, if the contract were drawn so as to give this specific and special authority to the architect. The Standard Documents, however, do not do this and, as pointed out, Article 24 is quite specific in its statement of a contrary intent and understanding.



INTERIOR VIEW IN STORE OF PENNELL, GIBBS & QUIRING CO., BOSTON.
H. B. PENNELL, ARCHITECT

THE AMERICAN ARCHITECT

Article 7 refers to the ownership of drawings and models. It provides that all models are to be the property of the owner and that all drawings and specifications and copies thereof, furnished by the architect, are to be the property of the latter. This clause, excellent, so far as it goes, must not be assumed to fully protect the architect, for it does not, as it does not go far enough. It recognizes the necessity of a special agreement if the plans are to remain the property of the architect. Its weakness lies in the fact that it is a term of a contract, which is entered into between the owner and the contractor, and to which the architect is not a party. The question of the ownership of plans lies, primarily, between the architect and his client. If the architect is to be properly protected on this point there should be an agreement between him and the client, direct, covering the ownership of the plans and specifications.

There is no objection to Article 7 and it is probably advisable that it should be included, so that the question of the ownership of the plans may be clear as between the owner and the builder. The architect should realize, however, that the agreement between these two does not adequately protect him and that, if his right in the plans is to be properly covered, it should be provided for in the agreement between him and his client.

Articles 9 and 10 have to do with the status of the architect and the general scope of his authority. Whether they be approved in the standard form, or disapproved, depends upon the personal point of view of the party entering into the contract, and upon the conception which one may have of the proper scope and character of the duties of the architect of today. The effect of these provisions and of Article 45, which should be read in conjunction therewith, is, undeniably, to cut down the discretionary activities of the architect to a minimum, and to leave all possible questions open for adjustment by arbitration. One good result of this course is that it may lessen, somewhat, the danger of an architect exceeding his authority and incurring liability to the owner, or to the contractor, as a result. Personally, however—and this is purely a personal feeling—I question whether the curtailment of the authority of the architect, as this authority is curtailed by the Articles above referred to, is in the best interests of the profession and its work, or in the best interests of the client.

It has long been customary to provide in the building contract that the architect, in substance, shall have full charge of the work of supervision and that all questions relating to the interpretation of the plans and specifications, and the like, shall be referred to and decided by him. All that the Standard Document form does is to provide that he shall have personal supervision and direction of the work. The

clause does not amplify this statement in any way and the general effect of the wording of Articles 9 and 10 is, certainly, to lessen the usual authority of the architect, in that the various provisions customarily used, in amplification of the phrase that he shall generally direct and supervise the work, are lacking.

It is of prime importance that the architect should not have the idea that he has authority to act for the owner on any point which may arise. Cautions on this point I have emphasized throughout these articles; it was one of the points upon which I urged special caution some years ago in my "The Law of Architecture and Building," and I have not changed my feeling in the slightest. I heartily approve, therefore, the purpose which underlay, I take it, the framing of Articles 9 and 10, viz.: the desire to make clear the fact that the architect has not a blanket authority and that any special authority, to be properly exercised by him, must be properly and specifically granted.

It seems to me that there should be, and that there is, however, a desirable middle course, between the failure to point out the limitations of the architect's status and the narrow construction of his authority as given in the Standard Documents. I cannot help feeling that the work turned out by the profession will be benefited, that the rights of the ordinary client will be better cared for and safeguarded, and that a more satisfactory job will be assured him, if the architect be given, under the contract, a much more general power as arbitrator, than that provided for, or contemplated by, the Standard Documents.

While believing thoroughly in the settlement of disputes by arbitration, rather than by resort to the courts, I yet feel that it is a mistake to leave too many details open for decision by arbitration. Any arbitration, at the best, involves time, delay and expense. It is, unquestionably, desirable that questions which should not be decided by the architect and which may lead to controversy between owner and contractor, should be settled by arbitration, between the latter two, if and when they arise. It is, I feel, equally desirable that as many points as possible should be settled and settled definitely, under the contract, by the architect, whose training and professional qualifications equip him, especially, to deal with them and to decide them with fairness to both parties.

I therefore favor, personally, a moderate modification of Articles 9 and 10 and of Article 24 also, in so far as the latter is related to them, so that they may specifically grant to the architect the right to decide questions involving the interpretation of the plans and specifications, and disputes between the owner and contractor, which naturally fall within the classification of points which an architect, by his

(Concluded on page 396)

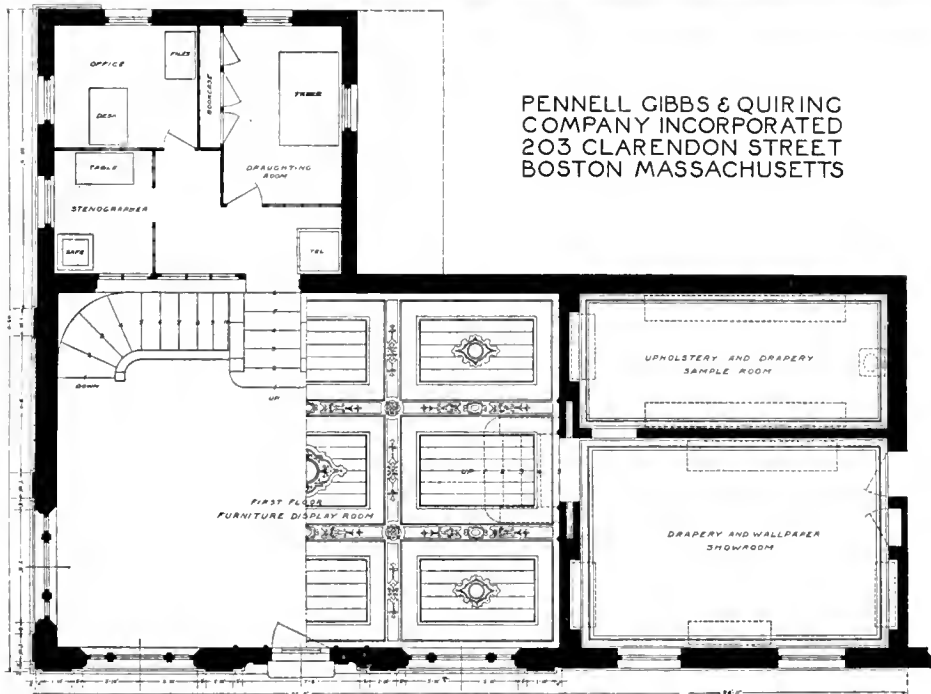

PENNELL GIBBS & QUIRING
COMPANY INCORPORATED
203 CLARENDON STREET
BOSTON MASSACHUSETTS

H. B. PENNELL, ARCHITECT

St. Peter's Church, Philadelphia, Pa.

(See reproduction of original drawing by O. R. Eggers on opposite page)

St. Peter's Church was built in 1758 and is very similar in its treatment to Christ Church. It is one of the few early Colonial churches in Philadelphia which does not follow the Wrenn type. In the end of this church there is a paladian window similar in design to that shown in Christ Church and there are a number of similarities in the two structures.

The upper part of the square tower of this church, with its slender octagonal spire, telescoping behind the battlemented roof, was added to the original church in 1742 by William Strickland. The detail shown in Mr. Eggers' sketch is a part of the original structure.

It is interesting to learn that in order to provide a means of raising the money to erect the steeple it was decided to hold a lottery. This lottery was advertised in the Philadelphia journals. Thirteen men were appointed managers, of whom Benjamin Franklin was one.



ST. PETER'S CHURCH, PHILADELPHIA, PA.
THE AMERICAN ARCHITECT Series of Early American Architecture





To Relieve Traffic Congestion in New York

ARNOLD W. BRUNNER, architect, and president of the Federation of Fine Arts, in an address recently made before that body, predicted that the New York City of the future will have its activities on the second floor instead of on the present street level.

This prediction was made during a discussion as to the ways and means of eliminating present congestion and providing for the future growth of the city. The view as advanced by Mr. Brunner is shared by the majority of those who have carefully studied traffic problems in this city.

This concentration of the building's principal activities on the second floor will directly result, if the proposed construction of elevated streets becomes a fact. The street levels would then be occupied by slow moving business traffic, while the upper levels would serve for the quicker moving and pedestrian traffic. The development of the second story would then logically occur. The ground floor of all buildings would be devoted to public passageways, parking spaces for motor cars and delivery entrances for merchandise to the buildings.

"There need be no fear," Mr. Brunner stated, "that these changes which must come will lessen the city's beauty." In fact he believes that if the people take the counsel of their architects and live up to the ideals that have already been outlined, we shall be able to remodel our streets and the buildings on them in a most satisfactory and artistic manner.

Elevated roadways in New York will, if present plans are carried forward, soon be built. A further extension of the plan for traffic relief is the construction of subterranean passages through the city to which all traffic that does not properly belong on the city's streets will be diverted.

These features are not the fancies of visionaries, but well matured plans of a practical nature to insure the city's welfare.

Contractors Adopt a Code of Ethics

ARCHITECTS should seriously view the efforts of contractors in formulating and adopting a code of ethics. It indicates that contractors very thoroughly appreciate their responsibilities in the production of an honest building. It is an effort on the part of contractors to prove their sincerity and a very strong intention to purge themselves of dishonest members.

The proposed code of ethics set forth in the report of a committee of the Associated General Contractors is one that has all the dignity and forcefulness of a professional statement. This report may with profit be read by our own organizations. It contains germs that will suggest some desirable amendments.

The premise of this proposed code as set forth by the committee is that as the construction industry vitally affects the well being, comfort and safety of the public in its home life and daily vocations, this fact entails on contractors a responsibility that is of a professional character.

This is undoubtedly true and therefore justifies the Associated General Contractors in their efforts to regulate their work along professional lines.

The motto of this association is Skill, Industry and Responsibility. No professional organization, ruled by the strictest code of ethics, may have higher ideals than those expressed in this motto. The contractors are quite right. A code of ethics properly enforced will place the Association more justly before the people and prove their contention as to the great importance of their work.

THE AMERICAN ARCHITECT

Architectural Quicksands

(Continued from page 392)

technical education and training, is specially equipped to handle and to decide.

If the architect act in bad faith, then, of course, the contractor should have the right to go behind his decision. Admitting, however, that the architect employed is a thoroughly competent and high class man, I can see nothing to be gained and much to be lost by making the arbitration provisions so sweeping as to, in effect, make all of the important decisions of the architect subject to review by a Board of Arbitrators. The competent architect is certainly as well qualified to pass upon these questions, as the arbitrators whose appointment is contemplated under the Standard Documents.

To allow appeals to the arbitrators to be taken broadcast, wherever the contractor is dissatisfied with the decision of the architect, necessarily lengthens the time of uncertainty and of final determination, and to a considerable extent must inevitably weaken the authority and power of the architect. I doubt if this is a desirable result. Assuming that the architect be given a broader authority and broader powers of determination than those contemplated by the Standard Documents, it is, of course, of prime importance that at the same time, the contract be so worded as to protect the architect in his exercise of the powers and authority so granted. In other words, while it is desirable, as I see it, to strengthen the position of the architect, as the man best qualified to pass upon matters in dispute, and to eliminate unnecessary controversy by making his decision final, in so far as that be possible, yet the architect must be so safeguarded, that in exercising these powers and this authority, he will not subject himself to any personal liability to the owner or to the contractor.

His position must be, in a word, akin to that of a judicial officer. That his action as an arbitrator may be essentially in the nature of a judicial act, I have already pointed out, and have referred to the fact that it has been legally recognized that such is the case.

Recent provisions of the New York law have greatly strengthened the effect of the decisions of arbitrators, and have given them a recognized force and binding effect which, before the change in the statute, they did not have. This marks a distinct advance in the desirable tendency to dispose of disputes by arbitration, rather than by long drawn out and expensive legal procedure. Unquestionably, it may be desirable to leave some of the more important and fundamental issues between the contractor and the owner open to arbitration and the change in the New York statute will facilitate the carrying out of this purpose. The idea of arbitration, as proposed

in the Standard Documents, is good, but its extension beyond a certain point will not, I believe, prove to be in the best interests of the owner or the architect.

It is undoubtedly true that the arbitration policy laid down in the Standard Documents tends to favor the contractor, in that it allows him to appeal, on so many points, from the decisions of the architect. Given a conscientious and highclass architect, however, I doubt if the contractor will be any the worse off if his rights are settled directly by the architect, without further arbitration or appeal, other than such right of appeal to the courts, as he may have under well recognized rules of law. It has been my experience that the decision of the architect, in questions involving the interests of the owner and contractor alike, favor the contractor quite as often as they do the owner. In fact, I know of many instances where the architect has deliberately sacrificed the good will of his client, in order to be fair to the contractor and to protect the latter on some point in which he has been right and the owner has been wrong.

Article 28 gives the right to the contractor to act in emergencies in cases *not considered by him* as coming within the provisions of Article 17. This provision, as it is worded, is dangerous, in that it in effect leaves it to the contractor to determine whether an emergency case comes within the provisions of Article 17 or not. Under paragraph 18, if the contractor considers that the case does not fall within the scope of Article 17, he apparently can proceed under Article 18. It would be much preferable and safer, if the clause in Article 18 "*not considered by the contractor as within the provisions of Article 17*" were omitted entirely, and the article so amended, as to provide that, in emergencies of the class indicated not coming within the scope of Article 17, the contractor may act without special instruction or authorization. This would make it simply a question of fact as to whether the emergency were such as is contemplated by Article 18 or should have been classified under Article 17.

The lessening of the scope of the contractor's discretion on this point has one weakness, in that it unquestionably would tend to make the architect loath to assume responsibility in an emergency, where it might be important that he should do so and that he should act promptly. As between this danger, however, and the danger of giving the contractor the extremely broad discretionary power contemplated by Article 18, I should think that a middle course might easily and with advantage to all concerned be worked out, on a basis of a more exact definition of emergencies, and at the same time the elimination of the objectionable phrase which leaves the decision so entirely in the hands of the contractor.

(To be continued)

Architectural Management—Part I

By FRANCIS B. ELLIS

Architect with Bethlehem Shipbuilding Corporation

THERE are two very important facts that are tending seriously to overthrow architecture as a necessary profession in the business of building construction. First, there is the utter lack of knowledge among laymen of the duties and functions of an architect. Second, there is a certain snobbish disregard for good, systematic, up-to-date business methods among architects themselves. To correct the first condition is a matter which must be taken up with the laymen, and should be the duty of the various architectural organizations—it is a serious problem, but it can be solved with the aid of public propaganda. The correction of the second condition, however, is a matter within the profession.

A man high up in the management of one of the big engineering corporations said to me that his organization was going to control all the architecture in that particular city. And that particular city was one of the biggest and most cultured on our Eastern Coast! I worked with that big corporation for over a year in their architectural department, and, say what you will, that corporation bids well to make good, in part at least, that boast. That corporation, together with other similar organizations, is employing steadily, at better salaries than they can obtain elsewhere, some of our best architectural draftsmen. Architecture with them, to be sure is not architecture, but it is a dangerous substitute, in that it has its appeal to the business man. And if we are going to turn up our noses at the business man and his point of view, then we are the snobs that so many architects are, and, as far as I can see, are beyond all recall.

What are we going to do? This is a big, serious question. There are some things that we can do now, there are others that we cannot do before a more careful investigation, and there are some perhaps that we can do nothing about. For the last six or seven years I have studied conditions in drafting rooms with some of our largest corporations and with our Government, and have arrived at certain conclusions which have a bearing on the above—and which I desire to set forth.

We all know that the words, "efficiency," "order," "system," "organization," "business," and other equally cold, hard words do not mix easily with such words as "art," "aesthetic," "beauty," and such warm, humanly sympathetic soft words. The true architect of today, however, is a skilful chemist, and can mix those very words, and mix them in their right proportions. Too much of one and not enough

of the other, however, will spoil the mixture. And unless you are just that sort of an architect, with just that knowledge of that sort of chemistry, you cannot hope to get much of Mr. Business Man's work to do. Remember that you must be able to command Mr. Business Man's respect on the lines of business methods, for to be an architect implies an ability to advise on business points.

I desire to outline simple architectural organization which I feel sure is the best way to start the reformation of our methods. This outlined organization can be expanded or modified to fit the business, but, I am certain that there is much more chance for long life and solid everlasting success, in a big strong organization than in a smaller one and I would therefore favor as large and powerful an organization as is within reason. Your business will sometimes be large and sometimes be small, and therefore you must have a "Telescopic" feature—that is a detail which you can work out for yourself.

YOUR organization must be made up of a head and of various departments. The function of the head is to direct, to command. The functions of the various departments are twofold—to advise the head through the department heads, and to produce the various work assigned the architect.

You have all heard tell of that famed sea captain who was constantly thinking of the comforts of his crew. We architects are just like that good man, and just as ridiculous in the eyes of others as he was to us. It is true that our draftsmen are architects-in-the-making, but for goodness sake, let them see that this is a business world that they are entering and that they must put up with some unfortunate discomforts because of that. "Nine to Five" may be all right for office hours, in fact, I favor rather short hours for the drafting room—but those hours must be kept—strictly kept! And during those hours every man must work for the best interests of the firm—and work hard and earnestly. I favor short hours for the drafting room for the reason that it is hard, confining, arduous work, but I feel that it is not unreasonable to request honest measure in time and work. I do not favor slave-driving methods, nor do I favor a spy system; in fact, I favor the honor system; the poor workman and the slacker are easy to pick out. Take your men into your confidence, show them what you are doing and why you are doing it; remember that they are young architects and that you owe them as

THE AMERICAN ARCHITECT

much open minded, broad, democratic, freedom as you are able to give—but show them that yours is a business and not a charitable organization. There is a certain spirit which you and your men must all have in common, a clear understanding at all times, and the morale of your organization need cause you no trouble.

Here follows an outline of the organization as I see it:

A. HEAD: Architect.

X.

DEPARTMENT OF DESIGN:

1. Division of Architectural Design.
2. Division of Structural Design.
3. Division of Material Design & Specifications.
4. Division of Mechanical & Service Design.

Y.

DEPARTMENT OF DRAFTING.

(Same divisions as above).

Z.

DEPARTMENT OF FIELD INSPECTION.

(Similar divisions as above).

THE HEAD—THE ARCHITECT

There must be a head to every organization—just as there must be a commander to every ship. It must be a one-man head—one to act as the final responsible director. This is a much more important point than it may at first appear, with the great argument in its favor that all government and business organizations agree on it. Of course, there may be partners, there may be equal partners as far as the profit sharing goes—but, from the operative end there must be one senior, president, director, or whatever you care to call this head. Remembering that this is an architectural firm that we are dealing with, its director must be an architect—a real architect in its broadest meaning. He must see clearly architecture from all points of view, not simply the aesthetic, the up-lift, the grandeur, the divine side of the thing, but he must see

the worldly aspect, the mechanical aspect, the cold mathematical aspect. Architecture is a solving of problems, and each problem has its conditions; avoid a condition and you avoid the problem. This director must, however, know his own limits—he must not be a “know-it-all.” There is no living man who can know-it-all in our great tremendously broad field. This director must have with him, at the head of each of their respective divisions, expert specialists. These men must be absolutely dependable, experienced experts—the sort of man in whom the director can place absolute faith and confidence—they must be able to take full responsibility, and this responsibility must be constantly given them.

DEPARTMENT OF DESIGN

The department of design must be directly and indirectly responsible for the origin of all schemes. The various divisions must work together at all times, there must be no silly jealousy, each individual designer must design as directed, giving in to each other as the conditions of the problem demand. In the design of a power house, for example, the most important demand is power production—it is clear, therefore, that the architectural designer will have to give over many of his pet ideas because of certain conditions that must exist under the charge of the mechanical designer. In one of the large corporations it is the custom to designate at the start of the job the most important consideration—for instance, the power house would be assigned as being a mechanical problem, and the mechanical division would be appointed the senior division.

The manager in charge of the design division must clearly see the importance of the various conditions of the problems, and understand the relative value of each—it will be his duty to direct accordingly. He, in turn, must not favor too strongly one division over another, his designers must be the best of their various callings, and must be given trust, backing and perfect freedom and confidence.



HOTEL WEBSTER, CHICAGO, ILL.
FRIDSTEIN & CO., ENGINEERS



THE LOBBY, LOOKING EAST
HOTEL WEBSTER, CHICAGO
FRIDSTEIN & CO., ENGINEERS



LADIES' PARLOR
HOTEL WEBSTER, CHICAGO, ILL.
FRIDSTEIN & CO., ENGINEERS





DINING ROOM
HOTEL WEBSTER, CHICAGO
FRIDSTEIN & CO., ENGINEERS

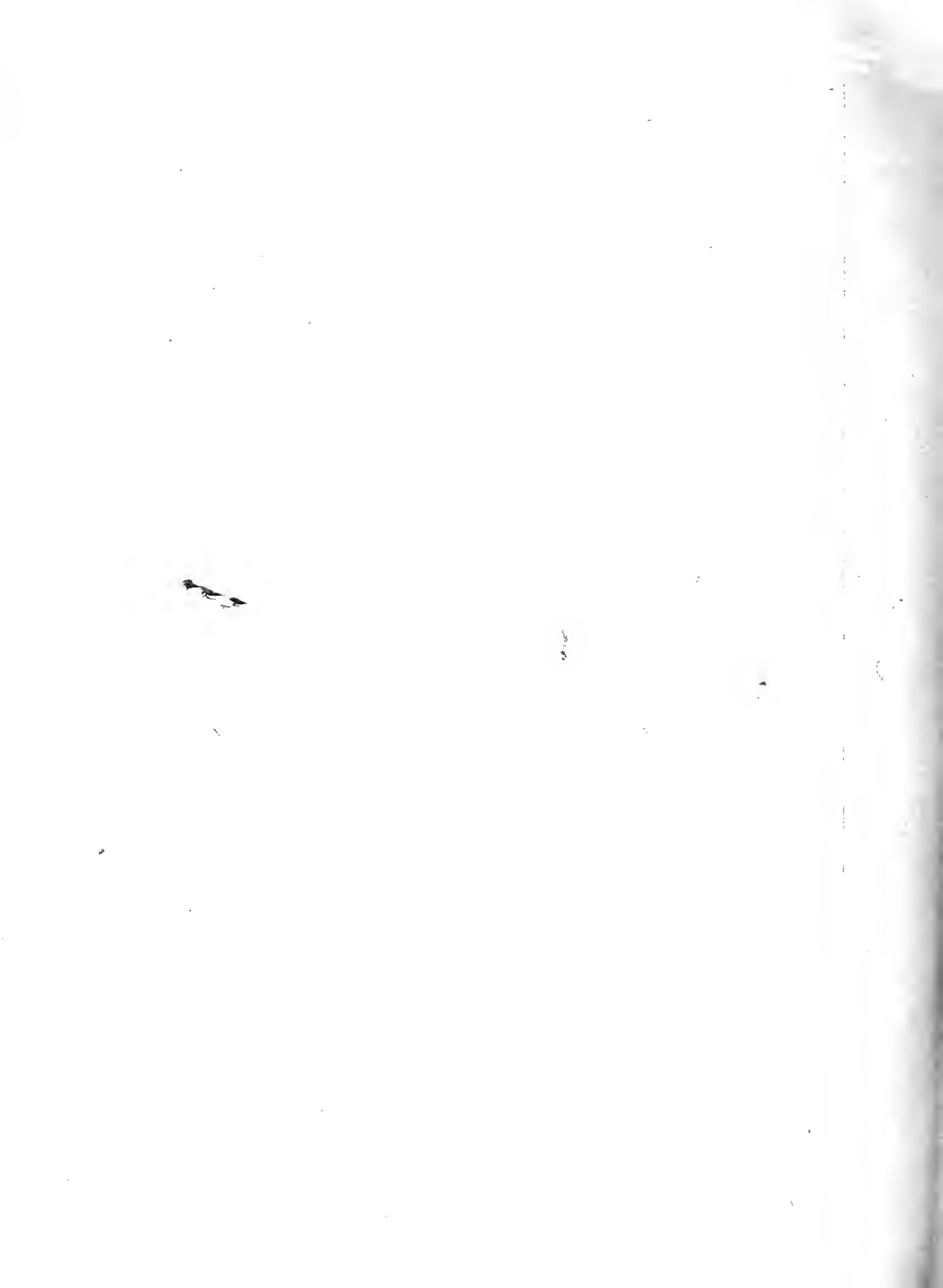

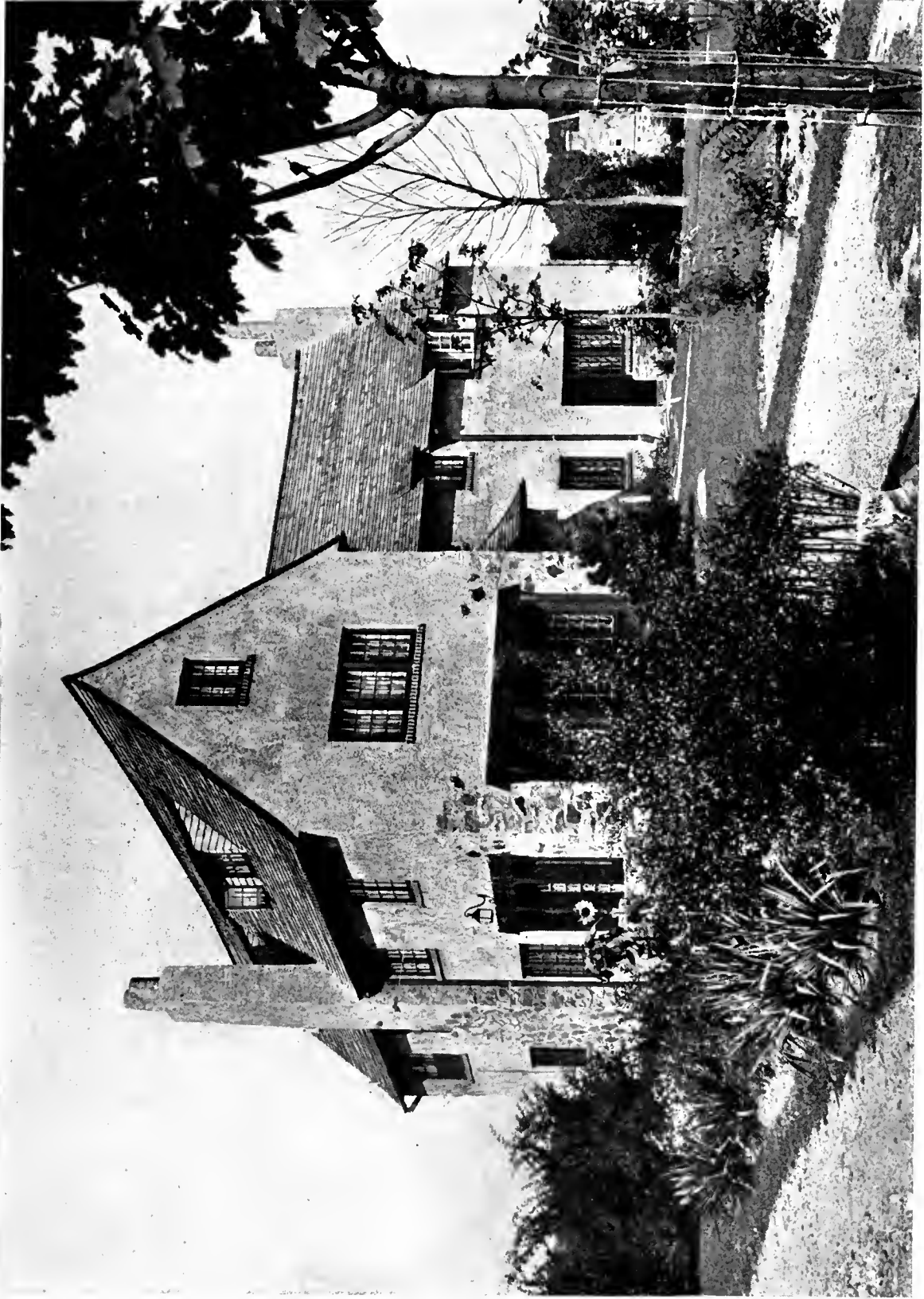

HOUSE OF CLARENCE McDANIEL, HARTSDALE, NEW YORK
JULIUS GREGORY, ARCHITECT

396





HOUSE OF CLARENCE McDANIEL, HARTSDALE, NEW YORK
JULIUS GREGORY, ARCHITECT

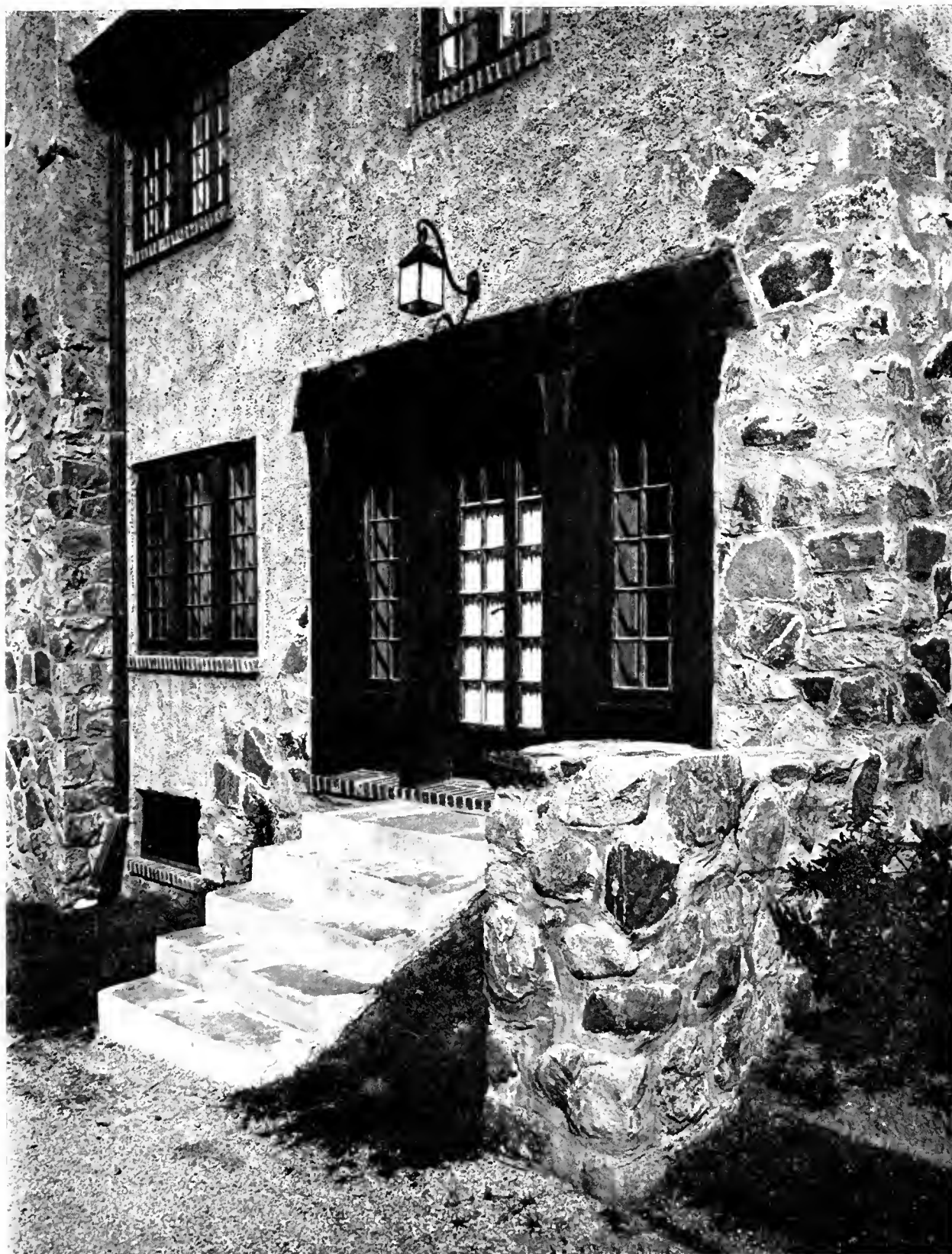

HOUSE OF CLARENCE McDANIEL, HARTSDALE, NEW YORK
JULIUS GREGORY, ARCHITECT



398⁸

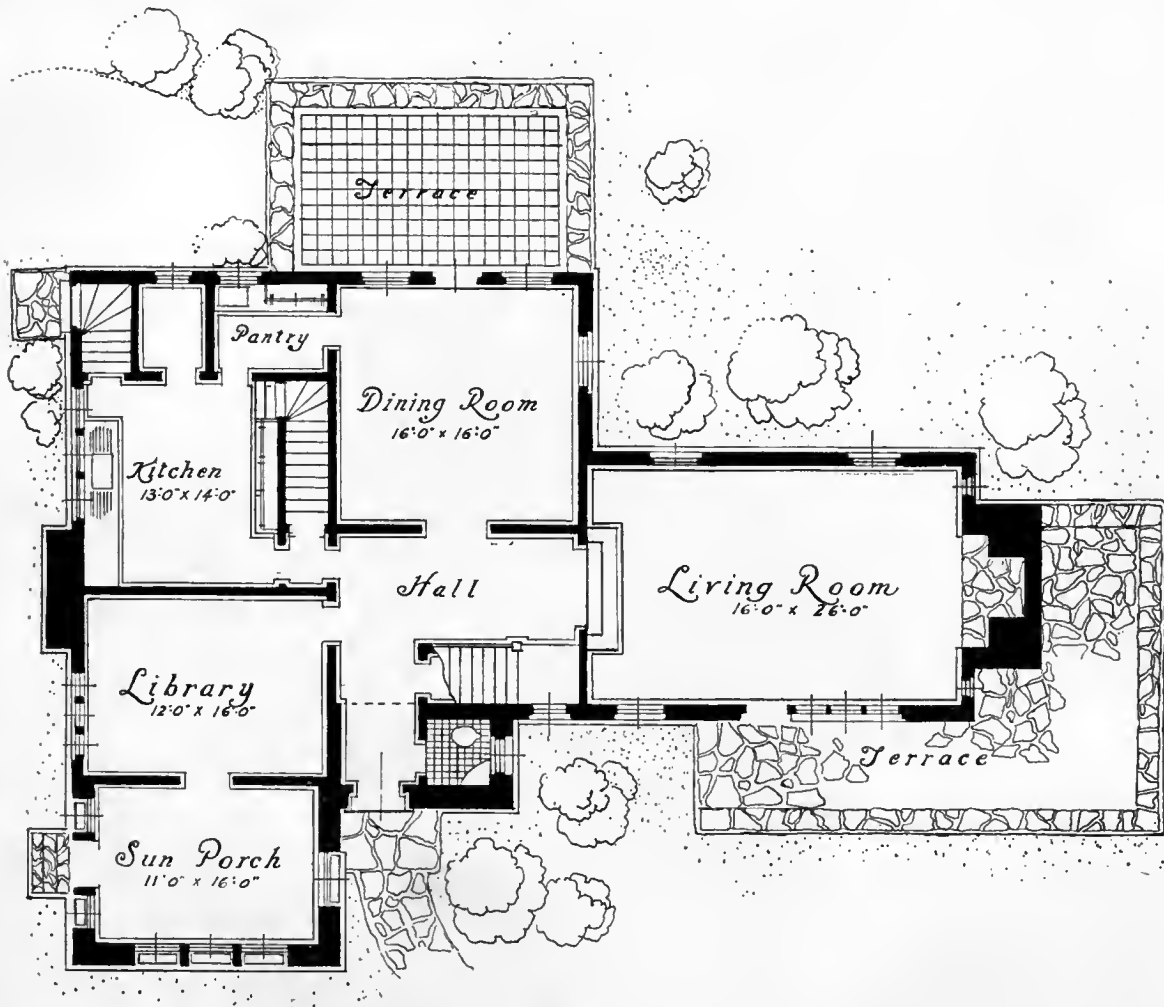
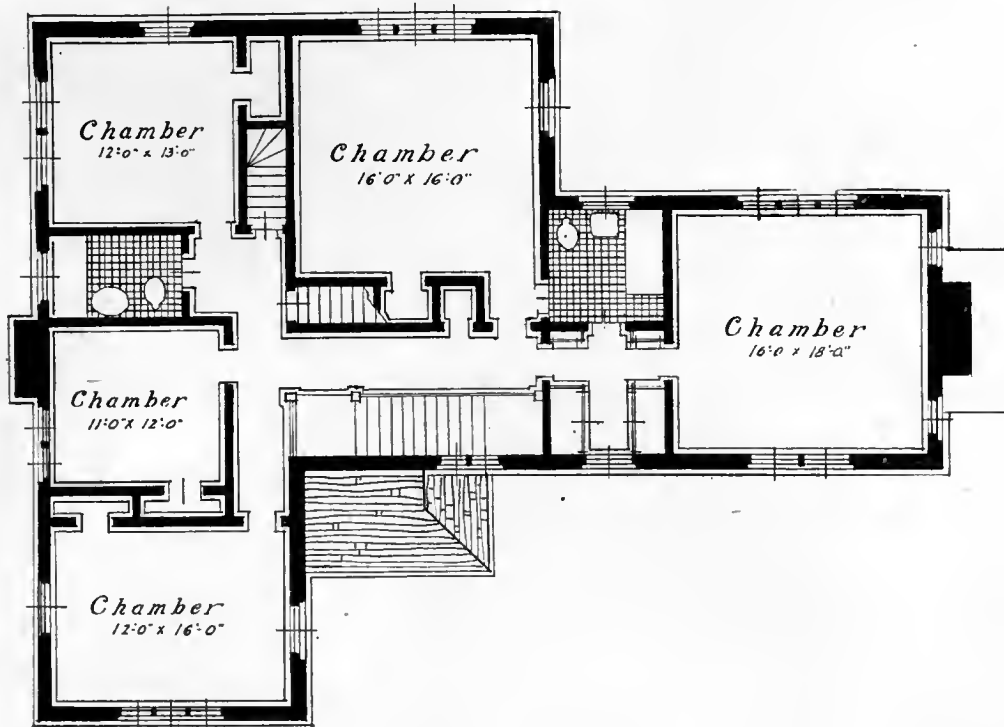

HOUSE OF CLARENCE McDANIEL, HARTSDALE, NEW YORK
JULIUS GREGORY, ARCHITECT

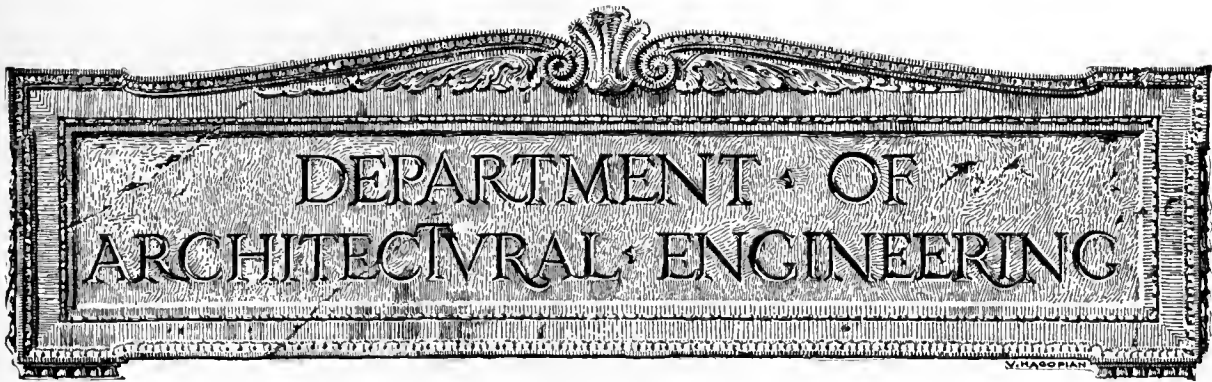

Effect of Recent Investigations on the Design and Operation of Heating and Ventilating Equipment—Part II

By CHARLES L. HUBBARD

HAVING described in the previous instalment of this article the method of testing the air of a room as regards ventilation, let us now see how the various constituents may be improved in case any of them fall below the required standard. In the problem just considered, the factor involving temperature, humidity and air motion was found to be only 92.8 per cent. of perfect, this condition being indicated by a difference of 4 deg. between the actual wet-bulb temperature (60 deg.) and the ideal (56 deg.) for the character of the work and the air movement. Assuming that no change can easily be made in the latter, it is evident that the wet-bulb temperature must be lowered, either by reducing the room temperature (dry-bulb) or the moisture content.

Suppose the room temperature was found to be 72 deg.; then for a corresponding wet-bulb temperature of 60 deg. we find the moisture content to be 0.612 lb. per 1,000 cu. ft. of air (see Table III, previous article), which gives a relative humidity of 50 per cent. for the given dry-bulb temperature (72 deg.). In order to keep practically the same quantity of moisture in the air and bring the wet-bulb down to 56 deg., the ideal sought, it will be necessary to reduce the room temperature to 62 deg., in which case we have, from Table III: dry-bulb, 62 deg.; wet-bulb, 56 deg.; moisture content, 0.611 lb. per 1,000 cu. ft. and relative humidity, 69 per cent.

If it is desired to keep the room temperature the same and vary the humidity, the same wet-bulb may be secured by reducing the moisture content to 0.428

lb. in 1,000 cu. ft. of air, in which case we have a dry-bulb temperature of 72 deg., wet-bulb 56 deg., and a relative humidity of 35 per cent. The most satisfactory combination for ordinary conditions would probably be secured by varying both the room temperature and the moisture content, so as to give approximately a dry-bulb temperature of 68 deg., wet-bulb 56 deg., moisture 0.506 lb. in 1,000 cu. ft., and relative humidity 47 per cent. If, for any reason, it was not desirable to change either the room temperature or the humidity, the ideal wet-bulb temperature might be raised to 60 deg. by increasing the air movement to 200 ft. per min. (see Table II), or, if this proved too high, conditions approaching the ideal might be secured by raising the velocity to 160 ft., which would give a wet-bulb temperature of 59 deg., without changing the other factors. A condition of this kind might occur in a room where a few of the occupants were sitting, while others were more actively engaged, in which case electric fans, so arranged as to increase the air movement over the latter group, might be all that would be necessary.

In a general way, the latest theory of ventilation requires nothing entirely new in the way of mechanical equipment, but rather a perfecting of that already in use and certain changes in the method of operation. The most important of the latter is that of recirculation or the returning of air to the fan from the inside of the building, either wholly or in part. This has a direct bearing upon the fuel question, as the heat required to raise the temperature of the incoming fresh air to that of the building is often

several times that required for heating purposes only, depending, of course, upon the outside temperature, the character of the building construction, and the relation between the number of occupants and the cubic space to be heated. In the average schoolroom, with a modern system of ventilation operated on the chemical theory of air dilution, nearly four times as much heat is required as would be necessary if the air was returned to the fan at approximately room temperature in zero weather. In shops and factories,

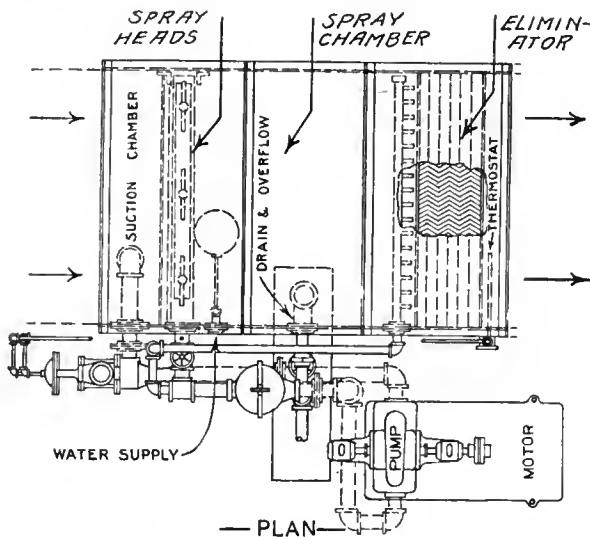

FIG. 8. DETAIL OF MACHINE ILLUSTRATED IN FIGURE

where the cubic space is much greater per occupant, the ratio between the heat required for ventilating and warming is much less, but it is probably safe to say that the heat requirements could be reduced at least one-half in the average case by re-circulating the air when the outside temperature approaches zero or when there is a high wind with a temperature ranging from 15 to 20 deg. above. If there is an abundance of exhaust steam which would otherwise be wasted, this would have no effect upon the fuel consumption, but in most manufacturing plants there are so many uses for the exhaust that live steam must be turned into the heating system more or less of the time during the winter season. This will, of course, vary widely in different cases, so that figures for general application have

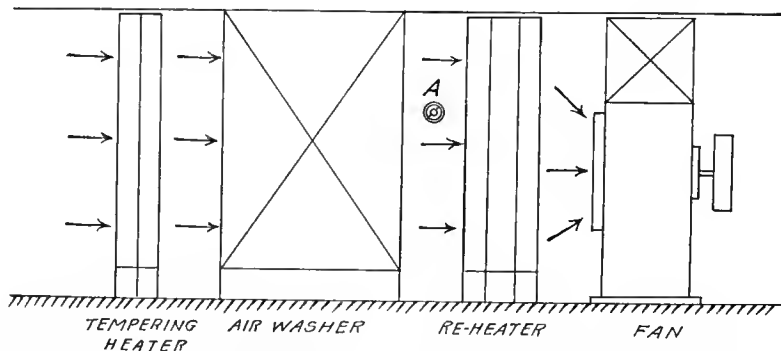

FIG. 9. DIAGRAM SHOWING ARRANGEMENT OF AIR WASHER IN RELATION TO THE FAN AND HEATERS

but little value. It is a simple matter, however, to make an estimate when the exact conditions of operation are known.

So far as the effect of re-circulated air upon the occupants is concerned, extended tests seem to show no harmful results from any diminution of oxygen or accumulation of carbon dioxide, this being taken care of by natural air leakage through the building construction. As a matter of fact, most plants operated on this system make a practice of taking in a certain amount of "make-up" air from outside, except in the coldest weather, especially where metal sash and concrete walls are used or the construction is such as to reduce natural leakage to a minimum. This practice naturally leads to the question, why supply *any* outside air if the chemical composition is of so little importance? This may be answered by saying that a certain small amount of fresh air is required for the purification of that expired from the lungs, as previously described. Furthermore, there are other conditions to be considered, such as fumes or dust given off by industrial processes, bacteria, odors, etc., which are sometimes best dealt with by air dilution in limited amounts. In the most modern plants, dilution for the above causes is either eliminated or reduced to a minimum by other means which will be described in some detail later on.

Let us now go back to the primary factors to be considered in "air conditioning" and see what equipment is necessary or available.

The first of these is temperature control, which, in view of its great importance, should, if possible, be automatic. The first objection to this is naturally the cost of installation. Automatic control does not necessarily mean more equipment or greater expense, but simply a readjustment of equipment for bringing about better results. It saves fuel by preventing loss of heat through open windows, which is an important item during the mild weather of spring and fall. Again, it is part of a general scheme for the reduction of boiler power where the volume of outside air can be reduced by re-circulation. Better

air conditions and the resulting increase in efficiency on the part of the occupants are points never to be lost sight of. Systems for the automatic control of temperature have been in use for many years and have now reached a

state of perfection that is very satisfactory.

The pneumatic type, which is generally employed for the ordinary heating and ventilating plant, consists of three essential parts, as shown in diagram in Fig. 1. First, a compressor, pressure tank and distributing pipes; second, thermostats placed in the rooms or spaces to be regulated; and, third, special pneumatic valves on the radiators, or diaphragm attachments at the mixing dampers. When the main plant makes use of compressed air for other purposes, the control system may be supplied from this source, provided the air is free from dirt, oil, and water and can be reduced to a pressure of 15 lb. per square inch; otherwise a special compressor should be employed. These are commonly electrically driven, although steam may be employed if the available pressure is above 20 lbs. In case neither electricity nor steam pressure is to be had, especially in small buildings, a hydraulic compressor, driven by water at city pressure may be employed. All compressors are automatic in action, being started and stopped by variations in pressure in the receiver or tank. Motor-driven machines are either belted, or driven by a worm gear, to secure the necessary reduction in speed. A thermostat is simply a device for opening a small valve and allowing compressed air to pass from the pressure tank to the radiator valve, or diaphragm operating a damper, when the temperature of the surrounding air becomes too high, and to exhaust the pressure when the temperature falls. Thermostats are usually designed to operate within a range of two degrees, that is, one above and one below the normal for which they are set. Motive power is produced by an expansion member, either of metal, vulcanite or a volatile liquid, which acts through changes in temperature. Pneumatic thermostats are of two general classes, the *positive* or quick-acting and the *intermediate* or graduated. The first of these is used in connection with steam and hot water heating, where the valves are to be fully opened or closed and quick action is desired, while the graduated type

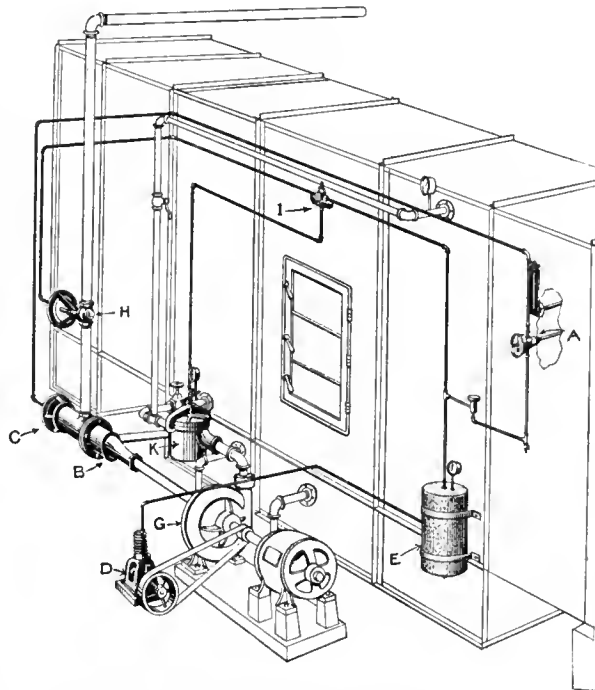

FIG. 10. DETAILS FOR THE AUTOMATIC CONTROL OF HUMIDITY BY MEANS OF AN AIR WASHER

is employed for the operation of mixing or by-pass dampers. In this case the thermostat works slowly, and simply varies the air pressure in the diaphragm mechanism operating the damper, and so holds it in any intermediate position necessary to maintain the room temperature desired. *Insertion* thermostats are constructed with the expansion piece of such form that it may be inserted into an air duct or fan chamber while the moving parts and pipe connections are outside and easy of access.

Multiple thermostats are of the general type just described, but having the expansion piece connection with two, three, or four operative mechanisms which act at different temperatures. For example, in Fig. 4, a multiple insertion thermostat of three points is placed in the duct beyond the fan and connected with the heating coil as indicated. When the air temperature falls to 69 deg. section No. 1 opens. If it still continues to fall, No. 2 opens at 68 deg. and No. 3 at 67 deg., which gives the full power of the heater in combination with the hand-controlled section. A different arrangement is shown in Fig. 5, where a four-point thermostat in the fresh air duct controls the number of coil sections, according to the outside temperature, and holds the air temperature in the duct beyond the fan at 68 or 70 deg. by means of a graduated insertion thermostat connected with a by-pass damper beneath the heater. There are various other combinations of both the positive, graduated and multiple thermostat, which may be made according to the results desired. While the pneumatic type is commonly used for heating and ventilating work, electric thermostats are employed to a considerable extent in certain industrial processes, as for the control of electric heaters, magnetic gas valves, motor-operated pumps and compressors in refrigerating plants, etc.

Mention should be made at this point of the application of thermostatic control to the various industries, which includes a large number of conditions aside from the heating and ventilation of work rooms. Among these are flue gas temperature control, bak-

ing ovens for enamels and japans, drying rooms for various purposes, storage rooms for special materials, sterilizers and pasteurizers, refrigerating rooms, and for the temperature control of liquids of all kinds. In many cases apparatus is already installed for purposes of this kind so that its extension to the heating plant is a comparatively simple matter. One of the later improvements, in the way of detail, is the substitution of the all-metal pneumatic valve for the older type employing a rubber diaphragm, in places where it is exposed to a high temperature. If the matter of expense prohibits the use of automatic apparatus, then hand control should be brought to the highest efficiency by placing it in charge of one man in each room, and grouping the radiation so that regulation

may be secured by the operation of a minimum number of valves, preferably one or two. In case of forced hot water, or the return-line vacuum system, this is generally possible. With the latter, a graduated hand valve in the supply main makes it a comparatively simple matter to regulate the steam supply to the heating requirements.

Humidity is commonly supplied in three ways, as follows: By evaporation in air washers, by delivering a fine spray directly to the air of the room through atomizing devices, and by the introduction of steam, usually

FIG. 11. ONE TYPE OF ATOMIZING HUMIDIFIER TO BE PLACED IN ROOM WHERE MOISTURE IS DESIRED

by way of the hot-air ducts. Moisture is removed from the entering outside air by lowering its temperature below the dew-point, thus causing a portion of it to condense. Moisture formed inside the building, as in dye houses, laundries, and paper machine rooms, is removed by supplying large volumes of fresh air at as low a relative humidity as possible, which absorbs the moisture and thus carries it off, the saturated air being removed by exhaust fans or vent shafts.

The air washer, owing to other features which it possesses, is used more widely than any other device for humidity control in general ventilating work. In describing the method commonly employed for maintaining a constant relative humidity in combination with a predetermined inside temperature, we will use for purposes of illustration a standard type of machine, shown in Fig. 7. This consists of a casing containing the spray heads, spray chamber and eliminator, as illustrated more clearly in Fig. 8. The gen-

eral location of the washer, with reference to the fan and heaters, is shown in diagram in Fig. 9. In action, air enters at the left, as indicated by the arrows (Fig. 8), passes through the spray chamber, where washing and the various interchanges of heat and moisture take place; then through the eliminator, which removes all unevaporated particles of water from the air. The pressure for producing the spray is furnished by a motor-driven centrifugal pump, the same water being used over and over again, with the exception of a certain amount admitted automatically by a float valve to replace that lost by evaporation. The temperature of the water is raised, as required, by a special steam heater located in the suction pipe of the pump. The general principle of operation for



FIG. 12. PAN HUMIDIFIER EMPLOYING A SUBMERGED STEAM COIL

humidity control is as follows: "When air is brought in contact with a spray of water at a higher temperature, evaporation takes place, the latent heat being drawn from the water, until the air becomes fully saturated at the entering temperature. From this point on, if the contact is contained, the temperature of the air increases, which also raises its capacity for moisture, and we have saturated air constantly rising in temperature and absorbing more and more water in order to maintain this condition. A machine of the

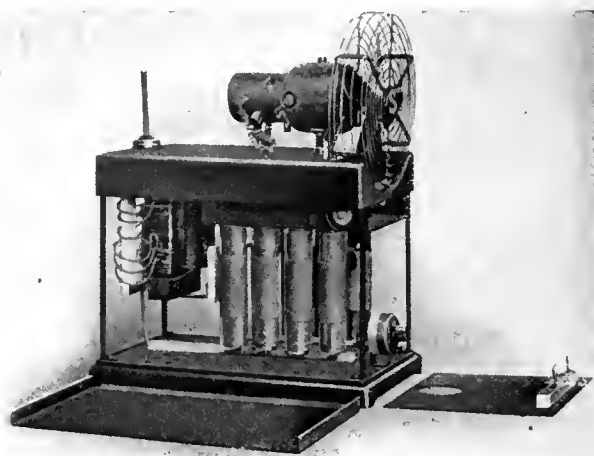

FIG. 15. STANDARD TYPE OF OZONATER (WITH CASING REMOVED) ADAPTED TO LARGE OFFICES, COLD STORAGE ROOMS, FACTORIES, AUDITORIUMS, HOSPITALS, ETC.

THE AMERICAN ARCHITECT

type shown in Fig. 7 utilizes this action by heating the spray to a point where saturated air will be delivered at such a temperature, that when raised to the desired room temperature, by re-heating, the contained moisture will be sufficient to give the required *relative* humidity at the latter or higher temperature.

thermostat; A D the air compressor for supplying the pressure tank E; H and I a safety device for shutting off steam in case of accident to the pump or thermostatic control; and K a strainer in the pump delivery pipe.

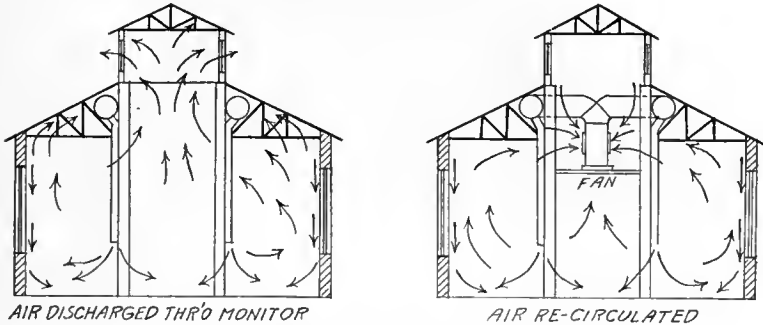

FIG. 13. TWO METHODS OF AIR DISTRIBUTION IN AN INDUSTRIAL BUILDING

For example, let it be desired to maintain a room temperature of 68 deg. with an ideal wet-bulb temperature of 57 deg. for the actual working conditions. Referring to Table III, we find for this condition each 1,000 cu. ft. of air should contain 0.549 lb. of moisture, which corresponds to a *relative* humidity of 51 per cent. and a *dew-point* of 49 deg. A dew-point of 49 deg. means that with the given amount of moisture (0.549 lb. per 1,000 cu. ft.) air will become saturated at 49 deg., and any cooling below this point will produce condensation and the formation of dew upon surrounding objects. Hence, in this case, the spray should be heated to a temperature which will deliver saturated air, at 49 deg., to the re-heater (see Fig. 9), which, in turn, raises the temperature, without addition of moisture, to 68 deg. for delivery by the fan to the room to be ventilated. In operation the entering air is usually raised to a point well above freezing by the tempering heater, which is commonly equipped with hand valves. The re-heater is automatically controlled by a thermostat placed in the room, and set at 68 deg. for the case under consideration. A graduated thermostat, set at 49 deg., is located at A and maintains the air leaving the washer at the desired uniform temperature by varying the amount of steam admitted to the spray-water heater. In Fig. 10 A is the thermostat just referred to; B a steam heater of the ejector type, placed in the pump suction for heating the spray water; C is a diaphragm valve in the steam pipe to the heater, controlled by the

From the above, it is evident that fluctuations in the temperature of the entering air are cared for automatically by varying the temperature of the spray water, while the temperature and humidity of the air delivered by the fan are kept practically constant, as previously described. With air entering at temperatures above 49 deg., but containing less than the required amount of vapor, the action is slightly different, as the latent heat of evaporation in this case is drawn both from the air and water. The result of this is to cool the air somewhat, after which the

water supplies the heat necessary to increase the evaporation to the desired point. If the moisture in the entering air equals or exceeds that required, no heating of the water will be necessary.

The action of the washer above described, as regards humidity control, applies only to the heating season. During the summer the problem is reversed

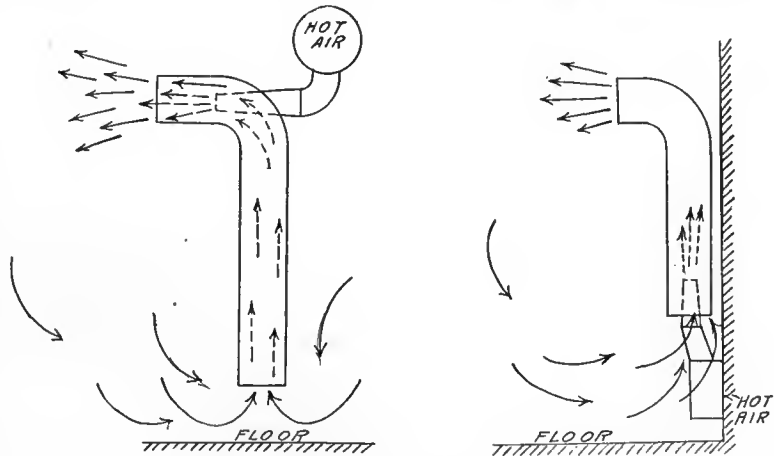

FIG. 14. TWO FORMS OF THE "CIRCULATING OUTLET". A PATENTED DEVICE FOR IMPROVING THE WARM AIR DISTRIBUTION IN CONNECTION WITH A FAN SYSTEM

and becomes one of cooling and de-humidifying.

The cooling effect obtained by re-circulated spray water is due entirely to evaporation, and at all other times when its temperature is at or above the dew-point of the entering air. The difficulty experienced under these conditions is the increase in humidity necessary to secure an appreciable cooling effect. With re-circulated spray water the relative humidity of the air leaving the washer will average about 85

per cent., which, at room temperatures of 75 to 80 deg., will prove very oppressive. If sufficient water is available from city mains or artesian wells to cool the spray to 3 deg., or more below the dew-point of the entering air, no evaporation will take place, and cooling will be effected by direct transmission of heat from the air to the water. Assuming a water temperature of 55 deg., and an air temperature of 80 deg., this condition will prevail for all relative humidities above 50 per cent. When this temperature difference exceeds 3 deg. moisture contained in the entering air will be condensed, thus lowering the humidity in proportion to the difference in temperature and the volume of water passed through the heater. For an air-cooling effect of 10 deg., with a rise in water temperature of 20 deg., it will require approximately 1.1 gal. of water per 1,000 cu. ft. of air.

When well water is not available, it is advisable to install a small refrigerating machine for cooling the spray. As to the amount of cooling possible under ordinary conditions, with re-circulated spray water, without refrigeration, we may expect a temperature drop of about 12 deg. in the air passing through the washer when the outside humidity is 30 per cent., and 4 to 5 deg. when it is 70 per cent. With spray water at a constant temperature of 55 deg., the drop in air temperature will be 19 and 15 deg., respectively, for the humidities noted above. As already stated, if the spray can be kept 3 deg. below the dew-point of the entering air, no increase in humidity will take place.

The following table will be found useful in this connection for determining the minimum water temperature necessary under varying atmospheric conditions:

TABLE X

Air Temperature, Deg. F.	Relative Humidity (approx.)			
	60 Per Cent.	70 Per Cent.	80 Per Cent.	90 Per Cent.
75	60	65	68	72
80	65	69	73	76
85	69	74	78	81
90	74	79	83	86
95	79	83	87	91

Various forms of atomizing humidifiers, which discharge the moisture directly into the air of the room in the form of a fine mist or widely used in connection with direct heating systems in shops and factories, especially in connection with textile work. Devices of this kind are independent of the ventilating system and are easily installed in plants already equipped with a fan and where the introduction of an air washer would be difficult or impossible. Humidifiers of this kind are independent of outside atmospheric conditions and are favored by some, particu-

larly where the other features possessed by a washer are not required.

One form of spray humidifier is shown in Fig. 11, and consists of a cylindrical casing inside of which is an atomizing nozzle with a disc fan above it for forcing the moist air downward into the room through a diffuser at the bottom.

The device shown in Fig. 12 is for placing in the main air duct leading from a fan or large indirect heating stack, and consists of a steam coil submerged in a pan of water. This arrangement is made automatic by using a diaphragm valve on the steam supply controlled by a humidostat located in the room, and attaching a ball-cock to the water supply. Other humidifiers make use of perforated steam pipes covered with a suitable material to prevent noise from the issuing jets.

Air motion and distribution are so intimately connected that the two are best considered together. In providing sufficient air motion for carrying away the bodily heat and moisture, care must be taken not to introduce strong drafts directly upon the occupants of the room. In spaces heated by direct radiation, electric fans, when properly located, will usually greatly improve conditions in this respect. These are commonly placed along the outer walls and adjusted to throw the air slightly downward toward the center of the room, although much depends upon the general arrangement of the room and the occupation carried on within it. Smoke tests are often of much assistance in locating fans of this kind and in studying air currents and distribution.

When a fan system of ventilation is employed, air movement is easily taken care of in most cases by a proper arrangement of inlets and outlets. Common arrangements for the blower system are shown diagrammatically in Fig. 13.

In the case of industrial buildings, where the rooms are of considerable height, the problem is to obtain a continuous movement of warm air through the zone of occupancy without producing drafts which are either too hot or too cold. The natural tendency is for the cooler air to settle near the floor, while the upper part of the room becomes overheated, a condition which results in underheating the occupied zone and increasing the loss of heat through the roof. The usual method of meeting this has been to discharge the warm air downward, either from overhead inlets at a high velocity or through downtakes ending 3 or 4 ft. from the floor and allowing it to rise and escape by leakage through the walls and roof. This may be improved upon in many cases by re-circulating the air, or a considerable portion of it, within the building, drawing the supply from the upper part, thus reducing the temperature near the roof and tending to equalize conditions throughout the room.

Another plan, which requires a considerable outlay for ducts, is to discharge the warm air slightly downward at a comparatively low velocity and return it to the fan through openings in or near the floor. A patented arrangement, recently put on the market, which seems to possess decided advantages as regards air distribution and elimination of drafts, is shown in Fig. 14. The important feature in this case is a "circulating outlet" working on the ejector principle, which draws in cooler air from near the floor, mixes it with a jet of hot air, and discharges the mixture horizontally at a height well above the heads of the occupants. The result of this is a thorough distribution of both heat and air, and a slow downward movement toward the floor owing to the suction thus produced. The hot air delivered by the fan may be at a much higher temperature than is ordinarily possible, thus reducing the capacity of the ventilating equipment by at least one-half under ordinary conditions. The temperature of the air delivered to the room is less than 100 deg. in the most extreme weather, and as this is still further reduced by mixing with the air of the room, overheating near the inlets, a fault of the usual arrangement, is done away with. "Unit heaters" which draw their supply from near the floor and discharge it horizontally at an elevation, give much the same effect. These, however, operate entirely on the re-circulating principle, and do not, in general, introduce fresh air from outside.

The best method of handling dust depends upon its source. If it comes from the outside and is drawn in by the ventilating fan, the difficulty is removed by the installation of an air washer, which is also available for humidity control in the winter and cooling in the summer, if desired. When the dust is produced by mechanical processes within the building, as much as possible should be removed at the source by means of suitable hoods connected with a strong exhaust. This applies especially to grinding and polishing machines, sand-blast, woodworking machinery, etc. When the dust necessarily escapes into the room, as in flour and cement mills, from the cleaning of castings in foundries, and in certain departments of woodworking shops, it is necessary to employ general exhaust ventilation, which may usually be accomplished by means of the regular ventilating fan. That is, by installing an air washer and re-circulating the air, bacteria of certain kinds are eliminated with the dust in the process of air washing. These organisms do not, as popularly supposed, fly about in the air like insects, but are a vegetable growth attached to some form of organic matter upon which they feed. Removing organisms of microscopic size by mechanical means, that is, by straining the air, is not practical, of course, but it is entirely possible greatly to reduce

their number by removing the substances upon which they exist.

Odors and fumes are treated much as fine dust, and should be taken at the source, whenever possible, through hoods connected with a strong exhaust. In certain cases, where they become diffused through the surrounding air, conditions may be much improved by general room ventilation, re-circulation through an air washer often proving effective and much more economical than discharging the air out-board.

A revival of interest in ozone, and a better understanding of its method of application to problems of ventilation, is of special interest in this connection. In its earlier applications, for the elimination of odors, the mistake was made of using a concentration of such strength as to prove an irritant, which has been found to be entirely uncalled for. For ventilating purposes ozone must be entirely odorless, and its detection in this way denotes too high a concentration. While it is not a stimulant, it has the effect of producing a refreshing exhilaration due largely to its power of destroying odors and giving relief from excessive heat. Just how the last condition is brought about is not clearly understood, although increased skin radiation has been suggested. That ozone prevents fatigue and increases the resistance of the body to disease seems to be an established fact, and it is desirable that ozonators be put on the same practical basis as other parts of a ventilating system.

The logical remedy for too great a proportion of carbon dioxide is evidently a larger supply of outside air, which is entirely feasible in most cases. This condition is not likely to occur, however, except in those industries where the gas is liberated in considerable quantities, as in the manufacture of carbonated waters, etc.

National Safety Council, 1921 Campaign

A plan to apply the Foch strategy which won the world war to the war on industrial accidents is announced at the headquarters of the National Safety Council in Chicago. For eight years accident prevention work, where it has been organized at all, has been conducted without any centralized control or direction. Although there has been through the medium of the National Safety Council a constant exchange of information regarding the most effective methods of preventing accidents, safety campaigns have been conducted independently in each of the 8,000 member plants of the Council. Despite the great strides which have been made in the prevention of accidents by these scattered campaigns, there are still approximately 22,000 workers killed,

THE AMERICAN ARCHITECT

and 600,000 injured in industrial accidents each year. It is expected that the new plan will make possible great reductions in these figures, and the saving of hundreds of thousands of dollars.

During 1921 the members of the Council under this new plan are for the first time attempting a unified and intensive accident prevention campaign. The plan announced by the Council calls for a concentrated attack, through all available means, on a different hazard each month, and these attacks are to be carried on simultaneously in all the plants operated by the members of the Council, except where special local conditions warrant alteration of the plan developed at headquarters.

Thus during January in approximately 8,000 industrial plants, mines, railroads and other public utilities throughout the country a special campaign was conducted against ladder accidents. It is estimated that 1,000 persons are killed in ladder accidents each year. The February campaign, now under way, is against neglect of minor injuries and infections arising therefrom.

Campaigns are announced for the other ten months against the following hazard:

March	Unsafe Clothing
April	Horse Play
May	Hand Tool Hazards
June	Standing or Sitting in Dangerous Places
July	Machinery Hazards
August	Inattention
September	Fire
October	Health Hazards
November	Careless Handling of Materials
December	Eye Injuries

Smokeless Cities May Be Achieved

Engineers Tell How Billions May Be Saved

Two billions can be added to the nation's wealth and the smokeless city achieved if coal waste, called medieval and inexcusable, is checked by municipalities, according to a statement of the committee on information and service of the American Society of Mechanical Engineers' Fuel Section, made public at the society's headquarters, 29 West Thirty-ninth street.

"When American potatoes were first introduced in Europe they were condemned for human use even by church edict," says the statement issued through Walter N. Polakov, chairman of the committee, organized to gather information on the energy situation and make it available for the general public.

"The reason for this action," the statement asserts, "was imperfect knowledge of how to cook them. The equally unwholesome and rapacious way of using raw coal has no longer the excuse of imperfect knowledge of technique.

"Advance of engineering science and high prices of domestic and industrial coal and gas challenge the municipalities to put a stop to this medieval way of using raw coal. Bituminous coal, even of poor grades, can be distilled at low temperature and yield fertilizer and ammonia, benzol, a superior substitute for gasoline, tar, a basis of most of our dyes, medicine, chemicals and perfumes, and a surplus of gas.

"If the 400,000,000 tons of coal annually burned in this country is so treated, the following products will be obtained: "1,200,000,000,000 cubic feet of fuel gas, 4,000,000 tons of ammonia sulphate, 1,000,000,000 gallons of crude benzol, 3,600,000,000 gallons of tar and 288,000,000 tons of artificial anthracite. The use value of all these commodities will be nearly \$4,000,000,000 instead of two billions' worth of raw coal.

"Municipalities, by underwriting such integrated multiple-production plants can serve the urban and suburban population with enormous economy by offering smokeless coal for domestic and industrial purposes; gas pre-eminently suitable for cooking, heating and lighting under mantles; tar for road surfacing, waterproofing, roofing, etc., and for chemical industries; benzol for automobiles and trucks; fertilizer for nearby farms and ammonia for ice plants, cleaning, hospitals, etc.

"The smokeless city will thus be achieved. At the same time large sums now spent for smoke abatement will be saved as well as gas oil and gasoline, and the price of coal and gas can be materially cheapened. District heating, electric service, power for trolleys and busses can be similarly included in this comprehensive plan of organizing cities to conserve our foundation of wealth—fuel."

Of Current Interest

Happenings and Comments in the Field of Architecture and the Allied Arts

Organization of Specification Writers Reports Progress

The American Specification Institute, concerning which preliminary announcements have been appearing from time to time in this journal, has now been incorporated and a permanent organization effected. The first Board of Governors consists of the following persons:

Chairman, Ralph W. Yardley, A. I. A., of Perkins, Fellows & Hamilton, architects; Executive Secretary, Gardner C. Coughlen, architect, of Weary & Alford, architects.

Chester L. Post, Mem. A. S. C. E., Secretary of the Condron Company, consulting engineers.

Frank A. Randall, Mem. A. S. C. E., of Berlin, Swern & Randall, architects.

Arthur T. North, Mem. A. S. C. E., architect and engineer.

We are advised that the response to the publication of the plan and scope of the Institute, which appeared in the February 16th issue of *THE AMERICAN ARCHITECT*, has been general and enthusiastic, indicating a keen appreciation of the proposed work.

The address of the Institute is 1144 American Bond and Mortgage Building, Chicago, Ill., to which inquiries concerning membership application blanks or other matters in this connection should be sent.

Will Teach Estate Management

A college of Estate Management has recently obtained a charter in England and will open in Lincoln's Inn Fields, London, in April. It is under the auspices of the Auctioneers' and Estate Agents' Institute and has for its principal aim the promotion by all educational methods of the study of subjects pertaining to the control of land and house property. Students intending to practice in the country will specialize in agricultural law and forestry. Tuition by correspondence is one of the contemplated methods and a course is planned leading to a B. S. degree in estate management recently instituted by London University. Land surveying, the valuation of land and buildings, the principles of taxation and the construction of buildings are subjects included in every course. The experience in England as elsewhere has been that the well-being and prosperity

of tenants depend largely on the efficiency with which estates are managed, and recent investigations have shown a marked diversity of conditions not due altogether to the possession or non-possession of good intentions on the part of landlords but largely to the extent to which they have been able, either personally or through their agents, to react to changes in economic conditions and to base their relationship to their tenants upon familiarity with their everyday problems.

House Names

I liked the English habit of naming their houses it shows the importance they attach to their homes. All about the suburbs of London and in the outlying villages I noticed nearly every house and cottage had some appropriate designation, as Terrace house, Oak-tree house, Ivy cottage, or some villa, etc., usually cut into the stone gate post, and this name is put on the address of the letters. How much better to be known by your name than by your number! I believe the same custom prevails in the country. . . . It is a good feature. A house or a farm with an appropriate name, which everybody recognizes, must have an added value and importance.

—John Burroughs.

Rotch Scholarship Examinations

The preliminary examinations for the Rotch Traveling Scholarship will be held at the office of the Secretary, C. H. Blackall, 20 Beacon Street, Boston, on Monday and Tuesday, April 11 and 12, 1921, at 9 A. M., to be followed by the sketch for Competition in Design on Saturday, April 16. The successful candidate will receive annually for two years an amount which it is hoped will not be less than \$1,400 per year, and maybe more, depending upon the funds, this amount to be expended in foreign travel and study during two years.

Candidates must be under thirty-two years of age and must have been engaged in professional work during two years in the employ of a practicing architect resident in Massachusetts. Holders of a degree from a recognized architectural school may present their certificates in lieu of the preliminary examinations.

Candidates are requested to register at the office

of the secretary as long before the examination as practicable.

For Government Service

United States Civil Service Commission announces an open competitive examination for architectural designer. Two vacancies in the Philippine service, each at \$4,000 a year, and vacancies in positions requiring similar qualifications, at this or higher or lower salaries, will be filled from this examination, unless it is found to the interest of the service to fill any vacancy by reinstatement, transfer or promotion. Employees in these positions will be allowed necessary expenses when absent from headquarters in the discharge of official duties. Applications will be rated as received until June 1, 1921. Applications for information concerning examinations for the Philippine service should be addressed to the Civil Service Commission, Washington, D. C.

Scientists to Delve in Ruins of Old Palestine

The history of primeval man and the origin of the Canaanites will be sought by a party of scientists and biblical students when they leave in June for ancient Palestine. The archeological expedition will center its excavation activities on the site of Beth-Shan, one of the oldest towns mentioned in the bible. The work will be under the direction of the University of Pennsylvania museum and is expected to take three years.

Beth-Shan, at present a mound of earth near Mount Gilboa, west of the river Jordan, in the valley of Jezreel, has had at least seven cities built upon it by successive bands of conquerors. Beth-Shan is first recorded in the book of Joshua, in relating the failure of the Israelites to take the town from the Canaanites because the latter used "iron chariots" in their warfare.

It was also on the walls of Beth-Shan that the bodies of Saul and Jonathan were exposed after the fatal fight on Mount Gilboa when the town was finally seized by the northern Israelites.

Beth-Shan was later taken by the Egyptians who were followed by the Babylonians. Then the Scythians followed the Greeks under Alexander the Great, who changed the name to Scythopolis. Pompey succeeded Alexander and Beth-Shan took on a Roman grandeur.

The Arab bandits finally stole the last vestige of Roman power and turned it over to the Turk who were driven out in the late war by the British Expedition under General Allenby.

Napoleon the Great in his Syrian campaign fought one of his greatest battles on the town's site.

New York Society of Architects

A large and exceptionally interesting meeting of the New York Society of Architects took place on Tuesday evening, the 15th inst., at the Society's headquarters, the United Engineering Societies Building, West 39th street, Manhattan, President James Riely Gordon in the chair.

A main feature of the proceedings was a talk on the Production of Genuine Wrought Iron Pipe, by Mr. J. K. Aimes, of the Reading Iron Company, Pennsylvania. The lecture was illustrated by moving pictures, showing the whole process of manufacture, from the smelting of the iron ore to delivery of the finished product from the foundry. A rising vote of thanks was accorded Mr. Aimes at the close of his address.

Discussion of the Bill for the State registration of architects followed, and members were urged to write their respective representatives in Senate and Assembly to support the measure. The Bill of Superintendent Rudolph P. Miller, requiring registration of all persons applying for building permits and having charge of construction work, gave rise to considerable controversy. The good intent of the proposed measure was generally admitted, but on motion by Mr. Henry Holder, the Bill in its present form was finally disapproved.

The revival of the proposition to remove the three-family house from the jurisdiction of the Tenement House Department, was hailed with approval by the meeting, and members were urged to support the Bill now being brought before the Legislature by Assemblyman Walter F. Clayton.

After adjournment for refreshments, further reports were made and correspondence read. The treasury was reported to be in a very satisfactory condition, and five applications for membership were announced.

Birth of the Skyscraper

The skyscraper was undreamed of—until White-law Reid laid the corner-stone of The Tribune building in 1874, states a recent biography by Royal Cortissoz. The Florentine campanile that he then lifted into the air gave his contemporaries what was, for them, a greater sensation than their descendants have received from Manhattan's tallest towers. Voyagers coming up the bay hailed it with astonishment, little imagining the formidable structures it foreshadowed. The sky-line it broke was that of an essentially flat, low-lying city. In Reid's eyes New York was not then precisely beautiful. So we may judge from the instructions he sent to Clarence Cook in 1870, with a request for a series of architectural articles. "What I want," he wrote, "is first a crisp editorial on the

THE AMERICAN ARCHITECT

prevailing lack of architectural taste in New York, the dreary miles of brownstone fronts, the worthlessness of brownstone as a material for building, the monstrosities given us by our wealthiest men." Then article after article was to be written, discussing the question of architecture in our cities generally, but particularly in New York. The "frightful example" was to be fearlessly pilloried, and suggestions for a rational architectural reform were to be made. I happen to know that he never thereafter lost his interest in the physiognomy of New York or his solicitude for its betterment. He kept The Tribune always stanch for public improvements and a steady supporter of the Municipal Art Commission, when that serviceable body came into being.

Razing Paris Forts

Two thousand workmen's homes, an agricultural exposition building, and a city university are among the structures to be erected on the sites of the old fortifications of Paris. Rapid progress is being made in the work of razing the forts, according to advices received by the Bankers Trust Company, of New York, from its French Information Service.

Workmen's co-operative societies are demolishing Forts 61, 62 and 63 whose sites will soon be put at the disposal of the Minister of Agriculture. On one of these sites the palace for agricultural expositions will be located. Two bastions of Clignancourt have already been leveled and construction of modern homes for workmen is to be begun at this place within a year.

Parks, squares, landing places for aeroplanes and open grounds having three times the present area of parks within the city will be provided through the removal of the forts. The Municipal Council has approved the project for a Cite Universitaire adjoining one of the outlying parks. The protecting moats of the old fortresses will be used as reservoirs and the space between the fortification walls and the present military zone beyond them is to be occupied by a boulevard which will circle Paris entirely.

Tax Exemption Passed in New York City

All dwellings built in the city of New York from April 1, 1920, to April 1, 1922, are exempt from taxation for ten years, now that the bill has been passed by the Board of Estimate, the Board of Aldermen and signed by the Mayor. Single family houses up to \$5,000 and two-family houses up to \$10,000 will be tax free. Apartments are tax exempt at \$1,000 a room, if not more than five rooms.

The first time the bill was brought up the Board of Aldermen denied its passage. That was in No-

vember. It only passed the Board of Estimate this time after "pulling teeth." It will be remembered that the ordinance was passed by the Legislature last October with the provision that the individual municipalities within the State would decide whether they wanted it or not.

Dr. Royal S. Copeland, city health commissioner, was pleased with the results and congratulated the board on its action.

"A lot of us fought hard for this Tax Exemption law. Building contractors and money loaning concerns assisted in its passage, and I believe the result will be an immediate home-building boom."

Passage of the ordinance should do much to stimulate the buying of vacant land for new building operations during the coming Spring and Summer, declared Joseph P. Day. By the terms of the new ordinance, he explained, stores may be installed on the ground floor, although the other floors must be used for dwelling purposes.

Personals

The architectural and engineering practice formerly carried on under the name of "Francis Chiaverini & Company," 117 Broadway, Providence, R. I., will be conducted in the future by Francis Chiaverini at the same address. Catalogues and samples desired.

Walter Thomas Williams, architect, No. 151 Fifth Avenue, New York City, desires manufacturers' latest catalogs and specifications to complete his files.

J. A. Pitzinger has moved from 607 Insurance Bldg. to 807 Southwestern Life Bldg., Dallas, Texas.

Ralph H. Oliver announces the re-opening of his office for the general practice of architecture at rooms 915 and 916, 115 South Dearborn Street, Chicago, Ill.

S. N. Crowen, architect, 838 Stock Exchange Bldg., Chicago, Ill., has rented offices in the new Wrigley building in that city, and will move there as soon as the building is completed, about May 1.

Frank Quinby, architect, has moved to 110 William street, New York City. He was formerly located at 92 Nassau street, that city.

Maxwell & Love, architects, have opened an office at 328 Frisco Bldg., Joplin, Mo.

A. L. Harris, architect, formerly located at 1504 H street, N. W., Washington, D. C., is now practicing at 728 Seventeenth street, N. W., that city.

THE AMERICAN ARCHITECT

Type of Bldg.	Location.	Type of Construction.	Equipment.	Foundations.	Total Cubic Feet	Contract Price or Bid Received Cu.Ft.	Cost Per Cu.Ft.	When Figures Were Taken.
ChurchCambridge, Mass.	Fireproof; brick and terra-cotta walls; steel girders, concrete floors.	Heating, indirect steam; lighting, electric.	Reinforced concrete.	386,400	\$400,000	\$1.04	Dec., 1920
HospitalSt. Joseph, Mo.	Fireproof; steel skeleton; ground and 1st floors reinforced concrete. Upper floors metal joist construction; walls brick and stone.	Vacuum steam heat; electric lights; modern plumbing; electric elevators.	Reinforced concrete.	1,400,000	750,000	.535	Fall of 1920
HospitalSt. Joseph, Mo.	Fireproof; brick and stone bearing walls; interior construction reinforced concrete.	Vacuum steam heat; electric lights; modern plumbing; electric elevators.	Reinforced concrete.	530,000	300,000	.566	June, 1920
High SchoolWinterset, Iowa	Fireproof; reinforced concrete; gypsum block partitions; finished floors wood.	Vapor steam heat; electric lights; modern plumbing.	Mass concrete.	462,000	208,000	.449	
High SchoolGarland, Utah	Corridors, halls, boiler and coal rooms are fireproof. Balance non-fireproof. Brick walls.	Gravity low pressure steam heat; electric lights; high grade complete plumbing.	Mass concrete.	360,270	97,013	.261	Feb., 1921
SchoolPeabody, Mass.	Floors, wood and cement. Non-fireproof; walls, brick; floors joist.	Heating, fan; lighting, electric; elevators, book lift. Plumbing, boxes, regulations; Hot water heat; electric lights; good grade plumbing; electric push button elevator.	825,000 Concrete.	.50	Concrete.		1920
City ResidenceBoston, Mass.	Fireproof; brick and terra cotta walls. Steel floor beams with terra cotta arches.	Hot water heat; electric lights; good grade plumbing; electric push button elevator.	Mass concrete.	180,000	270,000	1.50	July, 1920
Pottery PlantLouisville, Ky.	Mill construction; paving brick walls; steel girders and trusses, 1.3-4 inch floors; 1.8 inch maple surfacing; steel sash.	Waterproof concrete.	Waterproof concrete.	720,000	54,550	.075	Mar., 1921
FactoryNewark, N. J.	Mill construction; brick walls; cement surfaced floors.	Steam heat; electric light; standard factory plumbing.	Mass concrete.	729,000	182,000	.25	Apr., 1920
FactoryNewark, N. J.	Mill construction; brick walls; cement surfaced floors.	Steam heat; electric light; standard factory plumbing.	Mass concrete.	424,000	120,000	.282	Apr., 1920
WarehouseRock Island, Ill.	Non-fireproof; brick walls; wood floors.	Steam heat; electric light; small amount of plumbing; sprinkler system; 1 elevator.	Mass concrete.	414,000	91,806	.22	Nov., 1920
SchoolMiles City, Mont. ..	Fireproof, reinforced concrete; walls, brick; floors, slab concrete, maple in rooms, terrazzo in corridors.	Heating, steam; lighting, electric; plumbing, usual school sanitation (plunge, showers, etc.)	Concrete, reinforced.	1,091,000	240,000	.22	Jan. 15, 1921
SchoolDetroit, Mich.	Fireproof, reinforced concrete; walls, brick; floors, reinforced concrete beams and hollow tile.	Heating, Plenum system; steam H and V; lighting, electric; plumbing, toilet rooms and laboratories, plunge, showers; elevators, electric.	Concrete.	3,144,000	1,523,000	.484	Jan. 13, 1921
SchoolStratford, Conn.	Non-fireproof; walls, brick; floor wood joist.	Heating, direct, indirect; lighting, electric; plumbing, individual sewer.	Concrete.	496,614	251,000	.505	Dec., 1920
ResidencePortland, Oregon....	Non-fireproof; frame and stucco. Good finish.	Hot water heat; electric lights; first class plumbing.	Mass concrete.	47,770	17,752	.371	1920
ResidencePortland, Oregon....	Non-fireproof; frame and stucco. Good finish.	Hot water heat; electric lights; first class plumbing.	Mass concrete.	28,350	9,682	.342	Oct., 1920
HospitalJunction City, Kan. ..	Fireproof; reinforced concrete; gypsum block partitions; composition floors.	Vapor steam heat; electric lights; modern plumbing; electric dumb waiters.	Mass concrete.	182,000	70,000	.384	
SchoolMorning Sun, Iowa..	Fireproof; reinforced concrete; and steel; gypsum block partitions; finished floors, wood.	Vapor steam heat; electric lights; modern plumbing.	Mass concrete.	400,000	170,000	.425	May, 1920
SchoolLinwood, Kan.	Fireproof; reinforced concrete; gypsum block partitions; finished floors, wood.	Vapor steam heat; electric lights; modern plumbing.	Mass concrete.	350,000	140,000	.40	July, 1920
SchoolHartford, Conn.	Fireproof; concrete and steel; brick and tile walls; concrete floors.	Steam heat; Peerless Unit ventilating and direct radiation; electric lights. Porcelain plumbing fixtures.	Mass concrete.	382,200	182,504	.477	Dec., 1920
SchoolHopedale, Ill.	Corridors and stairs fireproof; balance semi-fireproof; brick walls; floors, wood and terrazzo.	Vapor steam heat; electric lights. 6 toilet rooms for pupils; 1 for superintendent; good grade fixtures.	Mass concrete.	405,165	116,759	.288	Jan., 1921
SchoolChandler, Ind.	Non-fireproof; brick walls; maple floors.	Direct, indirect steam heat. Electric lights. High grade plumbing.	Mass concrete.	225,000	56,838	.252	Feb., 1921

Weekly Review of the Construction Field

With Reports of Special Correspondents in Regional Centers

Building Boom in New York City

Gain of 61½ Per Cent. in Plans Filed in First Two Weeks of Tax Exemption—President Curran

Urges Loans for Building Operations—

This Is Only a Start, He Says

FIGURES from February 26 to March 12 show that plans for homes for 1,076 families, as against 666 families for the same period in 1920, have been filed in New York City as the result of the tax exemption ordinance passed February 26 in that city exempting, for ten years, \$5,000 of the cost of proposed homes.

This is an increase over 1920 of 410 families, or 61½ per cent. Out of the 1,076 families who will live in these new homes, 708 of them will be housed in one and two-family houses, as against 469 in tenement houses.

President Curran of the Borough of Manhattan states that almost every one of these homes will cost in the neighborhood of only \$5,000. The exemption applies to those projects on which construction is actually begun before April 1 of 1922, and, with a tax rate of nearly 3 cents on the dollar, the saving in ten years will be nearly 30 to 40 per cent. of the house, according to President Curran.

"This," he points out, "insures the safety of the investment against a possible further fall in cost of buildings."

"Apart from the increase in the number of homes," President Curran continues, "the fact that nearly two-thirds of them are likely to house people who own their own little homes is a particularly satisfactory result of the tax exemption ordinance."

Speaking of what this unusual activity foreshadows, President Curran said:

"It must also be remembered that things in the building line take time to move. Plans of construction, financial arrangements, including the choice and purchase of a suitable site, cannot be made in a day or week. These splendid figures are only the first sign of a great building boom in the erection of homes. If this boom continues as it has begun, and I believe it will, the people of small means who must live and work in New York City will eventually find rent relief."

Regarding loans on building operations, President Curran emphasized that at this time he desired to make a public appeal to everybody who could lend money for building operations to give a generous

and prompt response to the person who seeks his or her aid in the building of a home.

"No finer public service can be rendered today," he continued, "than the financing of thousands of new little houses that we must have at once in New York if we are to stop the backsliding in health, morals and all that goes to make up civic well-being, due to congestion in living quarters. Returns on the money so invested are substantial and safe, and they bring, besides, a great benefit in the happiness, comfort and good citizenship that more homes insure to our city."

"Move Materials Now"

Prominent Cement Manufacturer Adopts This As Slogan for Early Construction Activities—The

Reasons for Such a Slogan—Plenty of Cement

Available—Time to Start Construction

Work Is Now

One of the country's most prominent cement manufacturers has this to say about the "Building Demand":

A period of depression is largely a state of mind. We had one after the armistice. We are experiencing one now.

For a year or more up to several weeks ago the conduct of business resembled an obstacle race. Then railroad service was demoralized, production was low, labor scarce and inefficient, strikes frequent, materials hard to secure and high in price. It was difficult to get things done and everybody wanted to do them.

For the last several weeks business has had a clear way before it. Now railroad service is much improved, production is good, labor plentiful and more efficient, strikes infrequent, materials easy to secure and fairly low in price. It is easy to get things done—and apparently nobody wants to do them.

The construction industry illustrates this well. During the war building was held back by war restrictions. The result was a large accumulation of work waiting to be done when the armistice was signed. Yet everybody interested in construction work adopted a waiting attitude until about six months after the armistice. Then everybody who had building work to do tried to do it at once, but there was not enough transportation, labor and materials to go around. Prices soared—and the result was turmoil and disappointment.

Building conditions now are much the same as

when the armistice was signed. Because of the interferences just mentioned there is still a large accumulation of work waiting to be done. Yet everybody interested in construction work is adopting a waiting attitude. If continued it may result in turmoil similar to that experienced through the last half of 1919 and nearly all of 1920.

Everybody knows that there is a shortage of dwellings throughout the country and that rents are high. Rents will remain high until there are enough houses to supply the demand. But homes are not the only thing needed. Construction work must go ahead, notably highways and railroad improvements.

PLENTY OF CEMENT AVAILABLE

All the foregoing explains features of the cement situation not generally known. Some people have feared that there will not be enough cement available to supply the needs of a large construction program. This is a mistaken impression based upon past difficulties. The trouble in the last year of unusually heavy demand has been not lack of cement manufacturing capacity, but inability on the part of manufacturers to keep their plants operating at capacity. The curtailment of cement production was caused by strikes and scarcity of labor at cement plants, strikes in other lines of industry on which the cement plants are dependent, such as strikes in the gypsum plants, the strike of coal miners a year ago, the strike of the Illinois-Indiana coal fields in July, the strike of railroad switchmen which extended throughout the greater part of 1920, and the general lack of transportation facilities, including embargoes on the railroads. The ratio of cement production to manufacturing capacity for the entire year 1919 was only about 54 per cent., and thus far (to the end of 1920) about 68 per cent. The capacity of all cement mills in the United States is 125 million barrels or more annually. The most cement ever used in the country in any previous year was about 94 million barrels in 1916. That is to say the country has never used as much as 75 per cent. of its productive capacity, conservatively estimated.

There is now and will be plenty of cement to supply the country's needs as long as transportation and other conditions permit cement mills to operate reasonably near full capacity and to ship the finished product.

TRANSPORTATION STILL A PROBLEM

Many people are too complacent about the railroad situation. Undoubtedly railroad service has improved greatly through increased efficiency in operation, but the roads are not now called upon to do what they were called upon to do in 1920. Business in general is slowing down and farmers are holding back

their products from the market. Business in general is sure sooner or later to revive, and the farmer to send his stored products to market. When both or either of these things occur the railroads will again have more than they are able to do. If everybody wants cement, the farmer turns loose his grain, and business in general quickens, all at the same time, a lot of people are going to be disappointed by delays in their work.

At a time like this when owners, contractors and others may be discouraged from undertaking new projects, the fact should be given prominence that all effort, whether it be in the form of money, credits, materials, labor, transportation or what not, that goes into construction work, unlike that going into work of many other kinds, is not consumed. Effort expended throughout the country on many things that are consumed might well go into construction work, where the materials and labor and other things involved are not consumed but transformed into houses, industrial buildings, improved highways, water-power development and other valuable improvements that form additions to the permanent, taxable wealth of the country as well as tools for production of additional wealth.

If construction work is needed and if such wealth will add to the permanent wealth of the individual and the country at large, it should be carried on when not subject to interferences that have been present almost continuously since our entry into the war and which may again be present later.

The time to start this construction work is now.

Building Situation in the Middle West

(By Special Correspondence to THE AMERICAN ARCHITECT)

GILMORE, CHICAGO—There is everything to report regarding the building situation in Chicago except building. The air is full of plans and panaceas for the dearth of building, but when it comes right down to actual construction work there seems to be a decided hitch, with the result that construction is at a very much less than normal pace, though it is giving signs of improvement here and there.

Although the March building permit report has not been made public, it will show a good gain over March of last year and an even better gain over February of this year. Each day sees a gain in the number and value of permits issued, but it is unfortunately true that the issuance of a building permit is not necessarily followed immediately by a start of the building itself. Permits have been issued for several important business structures in the Loop district, but none of these has yet been started, though one or two important items of

THE AMERICAN ARCHITECT

building are scheduled to get under way very shortly.

The principal activity in building continues to center in small homes and the chief points of activity are in the suburban towns at the edge of Chicago. During the last week or so there have been some rather pretentious permits issued for apartment buildings, but mainly this branch of building is being held up while the rent situation is being threshed out in the state legislature. There is now pending before the legislature a measure known as the Kessinger bill, which would permit the appointment of a commission in the larger cities to determine just what constitutes a fair rental schedule. The Kessinger bill is an emergency measure and would not extend its authority for a longer period than 1925. Apartment dwellers organized into a tenants' protective association invaded the legislative precincts last week by special train to impress upon the legislators the importance, even necessity, of passing the Kessinger bill. Impressed by the numbers of the visitors, the legislature was more or less inclined to go through with the bill. Opponents of the bill were given their day in court, however, and they took occasion to point out that such legislation would serve as a further obstacle in the building hurdles and that it would prove a boomerang, if enacted, which would be most keenly felt by the tenant. Among opponents of the plan were representatives of various real estate organizations, building contractors and others. Apartment owners, apparently, are not very well organized to fight the bill and the general feeling is that the measure will be passed within a short time, however problematic its effect upon building.

The state legislature is also dipping another finger into the Chicago building situation by sending a joint committee of seven representatives and seven state senators here to investigate the alleged nefarious combine in which millwork manufacturers, contractors and union labor leaders are charged with having conspired to keep building costs up by keeping non-union building supplies out of the city.

This state of affairs has already had investigation at the hands of a federal grand jury, which returned more than forty indictments against firms and individuals. The cases, thus far, have not come to trial. It will be seen that the state officials are bestirring themselves to help the situation, but out of the whole thing there has come, thus far, very little actual encouragement of the hope that this official paternalism will really amount to anything in putting one brick on top of another.

The suggestion of bricks brings to the fore a battle which has been waged and is still being waged here between the proponents of the lumber trade and the folks who are engaged in manufacturing

or selling other lines of building material. The question has resolved itself into the following statement: "Has lumber taken its loss in the economic readjustment and is it at present the cheapest available building material?"

F. E. Davidson, president of the Illinois Society of Architects, recently gave a statement to the press in which he said that lumber is 150 per cent. higher than it was at its pre-war peak in 1914. This statement won instant protest from N. A. Mather, president of the Lumbermen's Association of Chicago, who avers that Mr. Davidson's figures are inaccurate. He brings forward a substitute table of lumber values, in which he estimates the present standard of lumber prices to be only about 64 per cent. above the 1914 peak. So bitter has the contest grown that the Lumbermen's Association has offered to turn over \$1,000 to charity if the figures submitted by Mr. Davidson can be substantiated by evidence submitted to an unprejudiced committee.

About the only general effect which seemingly has been created by this public argument is that of fortifying the public feeling that prices of lumber and all other building materials are higher than they will be later on and thus is bolstered the general determination of those contemplating building to wait and see what is going to happen.

Offsetting the watchful waiting policy is the interest being created by the "Own Your Home" Exposition, which is now open at the Coliseum for a ten days' run. Every inch of available space in the Coliseum has been taken, and the general assemblage of exhibits is a very excellently staged argument for home building right now. Architectural interests are well represented at the exposition. Architects are predicting that there will be a considerable increase in the demand for home plans following the exposition.

Demand in the local lumber and materials market continues to be very quiet. Spot business is in very small volume, and the market holds steady at old prices for the principal reason that demand is insufficient to establish a stable price list. Present quotations are:

Yellow Pine: B. & B. 1-in. \$95 to \$130, depending on thickness; 2 x 4, No. 1, 10 to 16 ft. length, \$51 to \$53; 2 x 6, \$48; 2 x 8, \$50; 2 x 10, \$53; 2 x 12, \$55; 13-16 x 3 1-4 z & b flat flooring, \$85 to \$90; 1 x 6, No. 2 common, \$48 to \$90. *Douglas Fir*: 2 4 S. in sizes up to 12 x 12, in length up to 32 ft., \$65 to \$70; 14 x 14, \$68 to \$73; 16 x 16, \$72 to \$75; 18 x 18, \$75 to \$80. *Hard Maple*: Four 1-4 No. 1 and 2, \$135; select \$120; No. 1 common, \$100; No. 2 common, \$65; No. 3 common, \$32. *Birch*: Four 1-4 No. 1 and 2, \$160; select, \$133 to \$138; No. 1 common, \$95 to \$100; No. 2 common, \$60 to \$65; No. 3 common, \$40. *Red Gum*: Four

¼ No. 1 and 2, \$150; No. 1 common, \$90 to \$92; No. 2 common, \$45.

Face Brick—Standard, vitrified red, \$32.00@34.00; Smooth, Indiana red, \$38.00@40; Smooth, Ohio red, \$38.00@40.00; Smooth, Pennsylvania red \$46.00@48.00; Smooth, buff, \$45.00@47.00; Smooth, gray, \$47.00@49.00; Rough, buff, \$44.00@46.00; Rough, gray, \$47.00@49.00; Variegated, rough texture, \$34.00@49.00.

Common brick, \$13.00 to \$16.00 per M. Portland cement, \$2.25 per bbl. Torpedo—Lake and bank sand, \$3.50 per yd. Crushed stone, gravel screenings, \$3.50 per yd. Hydrated lime, Ohio, paper, \$21.00 per ton. Hydrated lime, Ohio, cloth, \$29.00 per ton. (Includes sacks at 30c each). Hydrated lime, Wis. paper, \$19.00 per ton. Bulk lime, \$1.65 per ton.

Building News from the Pacific Coast

(Special Correspondence to THE AMERICAN ARCHITECT)

SEATTLE.—Pacific Coast jobbers are less concerned today in prices of pipe and sheet metals, including the popular building sizes, than in the demand, as stock now in the warehouses will take care of the movement at the present rate through the building season. Buying orders have ceased in both commodities, although arrivals on previous orders will continue for several weeks.

Jobbing interests seem to be satisfied for the present that the independent mills have cut prices on sheets and pipe to their limit, and that the next move must come from the corporation group. There have been some conjectures as to what they will do, particularly if Belgian mills offer steel on the Pacific Coast. Transportation would offer no difficulties. Belgian steel could be loaded on the Atlantic and taken through the Panama Canal and discharged on Puget Sound or other Pacific ports. Prices quoted are not yet within reach here and no freights are offered. Large offers, Coast jobbers believe, would have a bearish influence on all American mills.

The cement market is steady. With extensive roadbuilding programs in view according to appropriations at the present session of the Legislature, cement manufacturers believe they have enough business in sight to keep them in full operation during the season. These manufacturers tried last fall to operate all winter in order to have an accumulated supply for the spring and summer demand, but

financial conditions would not permit. It is the claim of the Coast cement interests now, as for the past five years, that the plants are incapable of meeting the demand when run at full capacity through the summer unless a winter's production is ready as a reserve. Jobbers do not therefore look for any radical fluctuations in the cement market.

Metal lath is weak. Jobbers are receiving frequent new price lists, and all seem to be headed downward. There has been some reduction in roofing and plaster board, and stocks are heavy. Buying has practically ceased.

The brick market is weak. Local manufacturers have steadily avoided operation beyond the point of active demand where possible due to high fuel and labor costs, and the plants have no accumulated stocks.

The board of public works of Seattle at a meeting this week ordered that Hendrickson & Alstrom, successful bidders on the job of building a new city fire station, pay the wage to building trades in effect at the time the contract was let. The contractors sought to reduce the wages 25 per cent. as of February 1, but the Allied Building Trades resisted. Building laborers on this job will therefore get \$6 per day.

Shippers handling building materials were notified that after June 1 all North Coast railway lines will abolish the combination carload rate and will make either through or proportionate rates. Materials affected are brick, cement, plaster, lime, clay products and gravel or broken or crushed stone. Shippers are preparing a protest.

The assessed valuation of Seattle city property for 1919 was \$241,294,294 against \$229,106,911 for the preceding year. The value of its building permits for 1920 was \$13,760,090, fourth down the list since 1908. The value of property exchange in 1920 was \$21,253,522.

The fir lumber market is steady. Eastern buyers are holding off until the new lower transcontinental rail rates can be instituted, which the carriers promise by April 1. Mills and wholesalers expect considerable new business from the East next month. Buyers express their conviction that fir lumber has struck bottom, but financing has not been easy.

Average prices at the mill for fir lumber during the week were \$10.50 for common dimension, \$40 for finish, \$20 for drop siding, \$12.50 for boards and shiplap, \$16.50 for plank and small timbers, \$43 to \$49 for vertical grain flooring, and \$23 to \$27 for slash grain flooring.

419^u

fratipica 8 No. 2363



CANAL AND BRIDGE OF THE MIRACOLI, VENICE

THE AMERICAN ARCHITECT

VOL. CXIX

WEDNESDAY, APRIL 6, 1921

NUMBER 2363



EMBRASURED WINDOWS AND SEATS, WEST PARLOR
 PIERCE-NICHOLS HOUSE, FEDERAL STREET, SALEM, MASS.
 SAMUEL McINTIRE, ARCHITECT

Samuel McIntire

Housewright-Architect, Salem, Mass.,

1757-1811

By W. H. HUNT, Architect.

LITTLE is known of the architects and builders of the splendid houses built in Salem prior to 1780. Several in Salem and its vicinity were designed by an English architect of note, whose name we have not been able to learn. It is also said that many of the sea captains and merchants secured designs from abroad which, no doubt, were modified and changed to suit the needs of this locality. Some

of the best work from 1750 to 1780 shows the influence of a work published in 1740 by Batty Langley and used extensively in this country. Many of the houses erected between 1780 and 1810 reflect the influence of James and Robert Adam. Beginning about 1800, the effect of Revett and Stuart's publications is also noticeable. In this period the Greek influence is clearly evidenced. While Salem builders

THE AMERICAN ARCHITECT

and architects made free use of those publications, they showed good taste and common sense in the adoption of the design.

At no time in the history of Salem have so many fine houses and handsome mansions been erected as during the period from about 1780 to 1815. A large part of the better work of that period we owe to Samuel McIntire, who was born, lived and died in Salem. He was the son of Joseph McIntire, a carpenter or housewright, as this trade was then known.



FRONT DOOR OF PIERCE-NICHOLS HOUSE
SAMUEL MCINTIRE, ARCHITECT

Samuel was born January 16, 1757. At an early age he learned the carpenter's trade in his father's shop, as in those early days, wood-carving was part of the housewright's trade. Samuel became expert in that particular branch of the work. In 1777 his father died, and his brother Joseph succeeded his father in business. Samuel married Elizabeth Field August 31, 1778, and his career began in earnest at that date, first as a wood carver of note, then as designer and architect. McIntire bought a three-story house at No. 31 Summer street, and there he dwelt until his death. In the rear of his house stood the

shop where most of the wood finish and carving for his work was prepared. In 1782 we find him the architect of the Pierce-Johnnot-Nichols house, one of his best examples. It is regarded as an architectural gem, perhaps the finest wooden house in New England now in existence, and is surely a monument to the genius of the architect. It seems remarkable that a man could make such progress as did McIntire during his thirty years of practice. As a designer he stood second to none in America, and without a doubt he was one of the greatest, if not the greatest architect of his period in this country. In the early part of his career McIntire executed most of his decorative work himself. As his practice increased this became impossible, and he was forced to depend upon the craftsmanship of his two brothers, Joseph and Angier, who succeeded their father as housewrights and master builders. This enabled him to devote his whole time to architecture. When we say that he was the greatest architect of domestic buildings it seems a strong statement. But as we can find no other of this period who did such a large volume of work as well as on such a high plane, such a statement seems justifiable.

Unlike many other prominent architects, McIntire had no one to herald him upon his death, with the result that many interesting facts in regard to his work have become buried in the old records of Salem and few have taken the time and trouble to dig them out. Yet, despite the oblivion into which his life had passed, the beautiful architecture of Salem and its vicinity, as planned and designed by McIntire, stands as an enduring monument to his life work. Many architects from all parts of the country have admired, studied and adapted its superb detail to their designs in modern buildings. His doorways, chimney pieces and other wood-trim have probably furnished the inspiration for more of the best modern Colonial type houses than the work of any other man. McIntire's activities appear to be confined to Salem and its vicinity, as we find no record of his work beyond, although we do know that he submitted a competitive plan for the National Capitol at Washington, which at the present time is in the archives of the Maryland Historical Society.

The historical collection of the Essex Institute in Salem has numerous references to McIntire's work as an architect, but to quote these would require too much space.

McIntire died February 6, 1811, at the age of fifty-four. Reverend William Bentley, on February 7, 1811, the next day after McIntire's death, wrote in his diary as follows:

"This day Salem is deprived of one of the most ingenious men it had in it—Samuel McIntire, aet. 54, in Summer street. He was descended of a family of carpenters who had no claims on public favor and

THE AMERICAN ARCHITECT

was educated at a branch of that business. By attention he soon gained a superiority to all of his occupation, and the present Court House, the North and South Meeting Houses, and indeed all the improvements of Salem for nearly thirty years past have been under his eye * * *."

In the *Salem Gazette*, February 8, 1811, appeared the notice of his death as follows:

"In this town Mr. Samuel M'Intire, carver, age 54 years, a man very much beloved and sincerely lamented * * *."

In the *Essex Register* of February 9, 1811, we find a notice as follows:

"In this town, Mr. Samuel M'Intire, aged 54. His talents in architecture, sculpture and music were distinguished. His manners combined suavity, purity and firm character. His industry, usefulness and consistent virtues gave him an uncommon share of the affections of all who knew him. By his own well directed energies he became one of the best of men. His funeral will be from his late dwelling house in Summer street at 3 o'clock on Monday afternoon, if fair weather. If not, the next fair day, which his friends and relatives are requested to attend."

On February 12, 1811, *The Salem Gazette* published the following obituary notice:

"Mr. McIntire was originally bred to the occupation of a housewright, but his vigorous mind soon passed the ordinary limits of his profession and aspired to the highest departments of the interesting and admirable science of architecture, in which he had advanced with a steady and sure step far beyond most of his countrymen. To a delicate native taste in this art, he had united a high degree of that polish which can only be acquired by an assiduous study of the great classical masters, with whose works, notwithstanding their rarity in this country, Mr. McIntire had a very intimate acquaintance. His native town (as well as other places) is enriched with many memorials in this art, whose excellence now, alas! only serve to sharpen the regret of the beholder for the loss of their author. He had also made a profession of the kindred art of sculpture, in which he had arrived at very distinguished rank. The uncommon native genius of Mr. McIntire displayed itself in many subjects not connected with his professional pursuits, and in the various objects to which his unerring taste directed him, he never failed of reaching a degree of excellence that would have been honor-



CORNER OF WEST PARLOR MANTEL
PIERCE-NICHOLS HOUSE, SALEM, MASS.
SAMUEL McINTIRE, ARCHITECT

able to a professed artist. He sometimes employed himself in drawing; he had an admirable musical taste, and was a good performer of instrumental as well as vocal music. Thoroughly acquainted with the principles of various musical instruments in the construction of them, particularly the organ, the most harmonious of all, he was directed by an ear of exquisite nicety, and an exactness of mechanism that insured success. Even on subjects of literature his casual observations evinced a degree of knowledge that surprised all who were acquainted with the variety of his professional and other pursuits. To these attainments (and these, notwithstanding he had been obliged to struggle against the want of an early education, were not all he possessed) he united an unaffected native politeness, and a mildness of deportment which delighted all who enjoyed his acquaintance. With these rare endowments of the mind, he possessed the best feelings of the heart, and his exertions in the cause of humanity (in rescuing a child from drowning) probably laid the foundation of that disease which had afflicted him for many

THE AMERICAN ARCHITECT

years and terminated his life. Conspicuous among all these excellences shone his unassuming modesty, his sterling integrity and his ardent piety."

The most illuminating picture of McIntire is found in the words written by his friend and wise counselor, Rev. William Bentley, and by other friends published in the *Salem Gazette* and the *Essex Register*. Corroborating the opinions already expressed, we find his gravestone bears the following inscription:

"In Memory of
Mr. Samuel McIntire,
who died Feb. 4, 1811:
Aet. 54.

He was distinguished for Genius in Architecture, Sculpture and Music: Modest and sweet Manners rendered him pleasing: Industry and Integrity respectable: He professed the Religion of Jesus in his entrance on manly life, and proved its excellence by virtuous Principles and unblemished conduct."

The Pierce-Johonnot-Nichols house at No. 80 Federal street is in excellent repair, and has long been considered the masterpiece of the genius of Samuel McIntire. It was one of the first houses of note designed by him, although it is said that his real masterpiece was the Elias Hasket Derby house erected on the site of the Market House. This house, which was several years in building, was said to be the most costly house erected in the vicinity of Salem during that period. According to the best information obtainable, the house cost \$80,000. Upon the death of Mr. Derby, only a few months after he moved into his new mansion, the gate posts and much of the interior finish, which included some of the best examples of McIntire's design, were removed and used in other houses then in process of construction. In 1815 the house was completely torn down and the land given to the town for a permanent market. The original plans, including preliminary drawings, are now at the Essex Institute, and can be seen there by anyone interested in studying the designs and details of this fine old mansion.

In going back to the Pierce-Johonnot-Nichols house, I want to quote a few lines written by Ross Turner, one of Massachusetts' noted artists and a great admirer of old Salem architecture. He says in part: "The house is a large three-story mansion, and the most substantial wooden building in Salem. The porch is, I take it, pure Doric and quite original in style and effect from any other porch or front door in Salem. The doorway itself is severely plain without sidelights, yet I think the combined effect of the porch and doorway is both picturesque and striking in the sweet simplicity and grace of the old lines and proportions, and appeals to everyone who sees it,

shaded by the old wisteria vine and old althea bushes when in bloom, covered by the pink and lavender of its flowers, making a picture not to be found in all Salem, with one exception perhaps of the side porch of the old Waters house on Washington Square." Mr. Turner's words express the opinion of many artists and students of architecture who have visited Salem seeking out the best examples of old Colonial architecture.

This house was erected by Jerathmel Pierce, a wealthy merchant. At that time the land sloped away on the rear to a wharf and warehouse on the North River, where his vessels docked. As it was several hundred feet from the rear of the house to the river, this land was developed and laid out as a terraced and formal garden, with parks, stone steps, wooden arches, fruit trees and many beautiful flowers and shrubs brought to this country from different parts of the world. It was his recreation and exercise to direct and care for the improvements made each year on his garden and flowers. Mr. Pierce lived in and enjoyed the comforts of this house for forty odd years. In about 1826 he lost his fortune and sold his home to George Jhonnot, one of his old friends. Then in 1840 both Mr. Jhonnot and his wife died within a very short time of each other and the house was left by will to George Nichols, a son-in-law of Mr. Pierce, to be held in trust during their lives for their four daughters; thus the property was eventually restored to the descendants of him who had erected it.

Like many other old houses built at that period, this house was long in building, as it was started in 1782 and not fully completed until about 1800, which means that nearly eighteen years elapsed from the time the foundation was put in until the whole house was completely finished, and that probably is the excuse for different types of architecture to be found. The western half, which was first built, is purely Georgian, and the eastern half, built several years later, reflects the Adam influence throughout, and seems to record the development of McIntire's mind towards the style of greater delicacy and refinement.

Along one side of the stable courtyard are several broad doors with elliptical fanlights over them, which give an effect of a colonnade. On the opposite side of this courtyard were the stable and several outbuildings. On the roof of one of those buildings there is one of McIntire's famous wooden eagles, which were used in connection with both public and domestic work and were popular at that time.

As a whole the depth, breadth and foreshortened third-story windows give it a more pleasing mass than most square houses. Worthy of note are the attractive balustrades of the low hip-roof, the fluted pilaster treatment at the corners and the free use of the Doric order, which is usually considered the

THE AMERICAN ARCHITECT

severest of orders, and better suited to public than domestic work. McIntire has succeeded through pleasing proportion and delicate detail in imparting a certain dignity. It is interesting to note that the gateways and doorways are closely allied and treated in harmony, carrying out the same design. The window treatment is simple but well proportioned, and very effective. The solid wood doors without sidelights were rarely found in that period, but painted dark with panels well spaced. McIntire succeeded in giving them a dignified appearance, which seems to bespeak a hearty welcome beyond.

Many who have visited and studied this old house have expressed great admiration for its interior adornment, as well as the exterior design. Upon entering the hall the stairway at once attracts attention on account of its unusual balustrade of the Chippendale influence, having four slender square balusters alternate with a sawed member, much like the well-known Chippendale chair back. The newel treatment suggests the volute of the Ionic order with balustrade winding about a simple turned column and the first stair-tread taking the outline of the rail.

The stair-ends are decorated with a jig-sawed double scroll. From the illustration showing the second story hall one can see the beautiful window on the stair-landing. Other features of interest in the hall include the hand-tooled molding of the cornice with a bead and dentil, each dentil having a flute carefully gouged upon it, the vertical fluted surbase of the wainscot, and looking backward one cannot help but admire the inside of the front doorway and

fanlight, which is a good example of excellent proportion and design. The whole treatment of this doorway seems to be very unusual, but the result seems to be pleasing and worthy of study.

Of the several rooms, the East and West parlor are particularly interesting, as they contain some of the best examples of McIntire's talent as a designer. The West parlor is a room about sixteen feet square, finished when the house was first built, along Georgian lines, although McIntire has given it certain individuality, which is to be found in nearly all of his work. It is substantial in character, simple in conception and graceful in proportion. The walls are finished with a dado, with molded base and surbase, and a heavy cornice at the ceiling. Particularly attractive in this room is the fireplace and its treatment, which has been made part of one side of the room, treated with wood paneling throughout. The doors and windows deserve careful study, the doors particularly for their molded panels, architraves and caps; the windows have paneled shutters folded into side pockets, and seats

beneath the windows, which seemed to be the prevailing custom in Salem at that time.

The East parlor has probably been studied and copied more by architects than the West parlor. This room was finished about 1800, at a time when McIntire's mind seemed to yield more to the Adam influence. This parlor or drawing-room is about 16 by 26 feet. Although this room was done over one hundred years ago, it has been said by several good authorities that America has no better example of the Adam influence than is to be found in this very



KIMBALL HOUSE, PICKMAN STREET, SALEM, MASS.
SAMUEL McINTIRE, ARCHITECT

THE AMERICAN ARCHITECT

room, and that it possesses the spaciousness which alone emphasizes to the full that subtle quality of nice balance between the plain surfaces and the delicate ornament to which the Adam manner owes its principal charm of refinement. The dado around the room has a molded surbase embellished with vertical fluting. The fluted pilasters have Corinthian caps resting on a pedestal at the top of the dado. The cornice is heavy with delicately carved moldings and frieze, and vertical reeded groups and rosettes in alternation. The windows have hand-tooled casings and paneled shutters. The chimney-piece is an architectural feature of rare beauty, and is without doubt the finest in Salem. It has delicate moldings, reeded pilasters and fluted band about the fireplace opening, dentil course under the shelf and decorated with elaborate carvings. There are pilasters above the shelf, and moldings surround a large panel over the chimney-breast, which makes a fine setting for a mirror or painting.

In the second story of this old house we find many interesting features. The western portion is finished in Georgian type, and the eastern portion Adam. The East front chamber is considered the best of the several rooms on the second story. At one end of

the room the chimney-piece is slightly recessed with a closet at each side, the entire end being treated in wood. The chimney-piece is similar in design to the one in the East parlor, although considerably simplified. In this chimney-piece McIntire has used columns instead of pilasters to support the shelf, and there is less carving and ornamentation. The reversed position of the reeded ovolo and dentil course in the cornice, the omission of the ovolo from the shelf, and the absence of the frieze of the pilasters at the side of the panel over the chimney-breast, also the fluted band about the fireplace opening, constitute the chief differences. This chimney-piece, on account of its proportion and selection of simple ornament, has rendered it one of the most admired in New England.

This old house is a delightful example of the Colonial architecture of Salem's prosperous days, and has probably been studied by architects more than any other one building in New England.

Of the interesting old brick houses now standing in Salem, one is the house at No. 180 Derby street, erected in 1810, originally the residence of Benjamin W. Crowninshield, Secretary of the Navy under Presidents Madison and Monroe. Like many of Me-

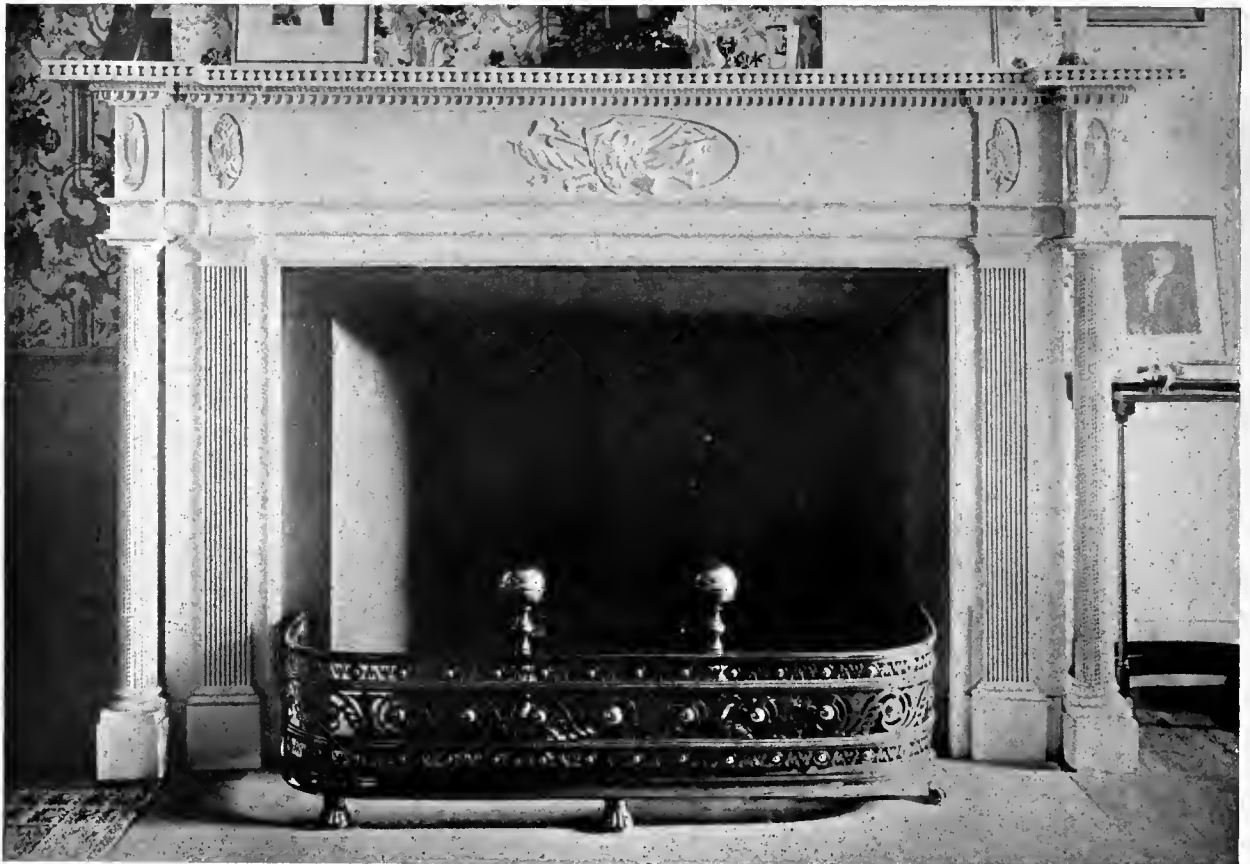

MANTEL IN KIMBALL HOUSE, PICKMAN STREET, SALEM, MASS.

THE AMERICAN ARCHITECT

Intire's three-story brick houses, this house has very little ornamentation except for the marble lentil and sills of the windows and the doorways, which are Grecian Doric in their simplest form, depending almost entirely upon their proportion for their pleasing effect.

It may be well to mention some of the historic events in connection with this house. In 1817 President Monroe made his tour through New England and the house was placed at his disposal during his stay in Salem. A banquet was tendered him July 9th and many prominent men were present. Later the house became the residence of General James Miller, who was Collector of the Port from 1825 to 1829. In 1826 William C. Endicott, Secretary of War during Cleveland's first administration, was born there. Several years later a wealthy merchant by the name of Robert Brookhouse became the owner, and he donated the house to the Association for the Relief of Aged Women, a society organized in 1860. In 1896 donations had accumulated to the amount of about fifty thousand dollars, and a large addition was built and many alterations made.

There are many old three-story brick houses still standing in Salem; most of them are the work of McIntire. Those that were not designed by him seem to show the influence of his genius. No doubt exists that he designed many of the houses that were built several years after his death. We find these old three-story brick houses on Washington Square, Essex Street and Chestnut Street. On Washington Square there are about eight, on Essex Street there are several scattered here and there. However, those on Chestnut Street are especially notable. This is a broad thoroughfare running east from Summer Street, about opposite the old railroad station. The street is bordered on either side by great elms. The houses set well back from the street, are nearly all the same type and were erected at about the same period. Architecturally speaking, Chestnut Street without doubt is one of the finest in America. Nearly every house on the street is a mansion, and a full chapter could easily be written on each one describing it historically and architecturally.

In most cases the so-called three-story brick houses were nearly square, usually the broad side of the



MANTEL IN EAST FRONT CHAMBER
PIERCE-NICHOLS HOUSE, SALEM, MASS.
SAMUEL McINTIRE, ARCHITECT

THE AMERICAN ARCHITECT

house to the street, and in many cases an ell extending back. In almost every case the third-story windows were foreshortened. Very little ornamentation was used, except the entrance porches, window lentils and sills, and attractive cornices. Many of the houses have classic balustrades around the deck of the roof. Several of the houses have a balustrade at the eaves consisting of square pedestals and turned balusters of classic outline. Nearly all of these houses will be found of excellent proportion, and the detail of cornice, windows, lentils, sills, blinds and entrance porches is so perfect that it gives a pleasing sense of a unity and balance to the entire structure.

We find from different authorities that about 1825 witnessed the end of the finer development of the Colonial architecture of Salem. After that the Greek revival which dominated New England building began to assert itself. There were some houses built at a later date which were somewhat Colonial in feeling, manifesting no pronounced development. They sometimes combined somewhat indiscriminately the features of former periods, and so lack the distinction of the old houses; although they have no value architecturally they are pleasing to the eye and substantial, comfortable homes.

Perhaps the old Colonial doorways have done more to make Salem famous architecturally than the houses themselves. Photographers, architects, students and artists from different parts of the country have photographed many of the old porches and doorways, and architectural publications have frequently illustrated them. They have been published in portfolio form, measured drawings have been made of many of them, and there is hardly an architect's office in this country that has not a few of them filed away as examples of merit. Probably one reason why they have been used to such an extent is that they were so easy to obtain. While we have chimney-pieces, stair-cases, interior details that cannot be excelled in any part of the country, the owners of the grand old houses have been loath to allow visitors to photograph and copy them, although a few have succeeded in doing so.

In many of the old houses we find the fences and gate posts designed in keeping with the porches, giving a certain pleasing foreground not otherwise to be obtained. I have heard it said that the doorways of Salem have a character and individuality of their own. One can readily realize that doorways reflect the character of those for whom they were built. Each is important as the entrance to the home; there a welcome is given and first impressions are received. Salem has many doorways which seem to express a sincere spirit with their graceful dignity and simple air of distinction. They are well worth the study of every student of architecture. One of the oldest doorways of which I wish to speak is known

as the Pineapple Doorway. The Pineapple house, No. 7 Brown Street Place, was erected in 1750 by Captain Thomas Poynton. In 1911 the doorway was removed and placed in the Essex Institute. It is a good example of the broken pediment; the pineapple in the center is said to have been brought over on one of the captain's ships. The pineapple was always kept brightly gilded and the leaves painted green.

The Pierce-Johonnot-Nichols porch, as will be seen by the illustration, is a good example of one of McIntire's porches for a front door without sidelights. Of several of that type that he designed, there is no better instance of pleasing proportion and nicely worked detail to be found in Salem. There is a fine eight-paneled door; few of its equal can be found in Salem. A semicircular fanlight under the porch roof admits light to the hall. The porch has smooth columns setting on plinths with a Roman Doric entablature impediment. The fence and ornamental gate posts with hand-carved urns provide an architectural setting of rare charm.

A good example of the Ionic porch may be seen on the Peabody-Silsbee house at No. 380 Essex Street. This three-story hip-roof square house, erected in 1797, is considered one of McIntire's best designs, executed in brick. Although strongly Ionic in feeling, the porch is absolutely unconventional and shows McIntire's skill for employing classic detail in new ways for freshening classic motives with new detail. The fluted columns with the enrichment of the neck of the capitals below the volute impart a distinctly Roman aspect to the whole. He has used the heavy cubical Tuscan plinths, as was his custom, in nearly all of his porches. Except for rosettes directly over the columns, the frieze is plain. The cornice has been repeated on a larger scale under the eaves of the house. The wooden door with its delicately molded panels, tiny corner ornaments, the leaded fanlight and sidelights, iron balustrade over the porch and iron stair-rail, are all distinctive, and, as a whole, the picture is very pleasing.

Another porch of similar type is the entrance of the Forrester-Peabody house at No. 29 Washington Square, now the Salem Club. The entrance porch of the Baldwin-Lyman house at No. 92 Washington Square is of a similar character, but has smooth columns, and no application of the order to the door frame. The beauty of this porch is greatly enhanced by the fence and gate posts. The most elaborate Corinthian porch in Salem is that of the Andrew Safford house at No. 13 Washington Square, erected in 1818. The porch combines the square and elliptical motives and is one of the finest specimens of the early architecture of the nineteenth century. Above the porch will be seen a heavy balustrade and Palladian window, a feature which serves to relieve the severity of the house.

Proposed Memorial Bridge Across the Hudson River at New York

ALFRED C. BOSSOM, *Architect*

IF plans at present maturing are brought to a successful conclusion, New York City will have another bridge approach, and for the first time from the West, or New Jersey side.

Many schemes have been put forward during past years for a bridge to span the Hudson. There are

sufficient reasons for such a structure. The traffic problems in New York subway, surface and elevated lines have been solved so far as present conditions would admit. Not satisfactorily, but fully to the extent of building capacity, owing to the geographical outlines of the city. The facilities have been taxed



FIG. 3

THE AMERICAN ARCHITECT



FIG. 1

to the point where the inconvenience of travel has caused many to move into New Jersey. There they have rapidly colonized an area along the Palisades that has transformed it from a far-away suburb to an urban community. There has long been a demand for better facilities of communication. The present means, combining at least two trolley rides and one by ferry before New York may be reached or New Jersey visited, are too time-losing to meet the approval of the vast number of people who sleep in New Jersey and transact business in New York. Better transit facilities have been demanded.

But it is not the passenger alone who has felt the lack of easy approach across the Hudson. The many

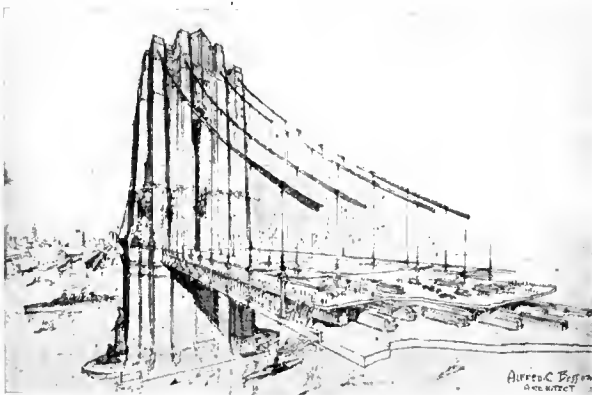

FIG. 4

converging railways whose terminals line the New Jersey waterfront have ever desired to find some quick method of delivering their freight, especially that of a perishable nature, at its point of distribution and consumption. A large cost item to the New York man in what he eats and drinks is the lighterage charge across the river. This charge makes an enormous total, and an equally large enlargement of cost.

Projects to bridge the Hudson River have, in one form or another, been before the people of New York for at least twenty-five years. The main obstacle has been the objections of the War Department, which controls the use of navigable streams.

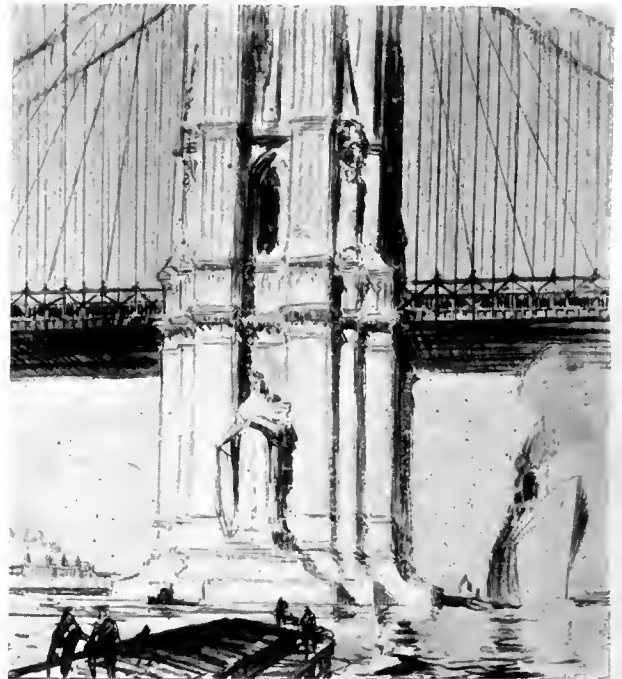

FIG. 2

But the development of modern engineering has made it possible to throw a bridge across the Hudson at even this wide part of it, with a span sufficiently high and wide to do away with the Department's objections, especially when there are so many good reasons why it should be built. Accordingly, the War Department today is in a receptive mood toward the project, and there is prospect that the proposed bridge will in due course become a thing in fact.

New York started its bridge building simply on a basis of utility. In the first bridge thrown across the East River there was no attempt to provide any architectural refinement. It was purely an engineering structure of engineering design. As the need for additional bridges developed the need for better architectural expression also developed and each structure

THE AMERICAN ARCHITECT

has been an improvement on its predecessor. The idea that the bridge proposed to span the Hudson should be a Memorial Bridge, has made it apparent that it should also be as architecturally excellent as is possible, and it is this idea that has dominated such designs as have thus far been presented.

The designs of Mr. Albert Bossom, architect, shown elsewhere in this issue of *THE AMERICAN ARCHITECT*, are a purely architectural expression of a memorial bridge, designed to give dignity to the structure, to meet the practical needs of an intercommunicating bridge and to serve above all as a memorial by a grateful people to its heroic dead. No bridge that failed to accent in the most emphatic manner every essence of correct architectural design combined with the most perfect engineering skill could serve so great a purpose as is proposed in this structure. It becomes primarily an architect's task, and it is an undertaking that an architect should dominate.

The bridge as planned by Mr. Bossom has its New York approach at Spring street and its New Jersey entrance at the foot of Thirteenth street. The approaches at either side will be important architectural features of the scheme. There will be wide plazas and park spaces. The effect of these decided features will undeniably be to create an improvement in their locations and result in a largely increased taxable valuation. The distance between these plazas will be over 9,000 feet.

At the center the bridge will have a clear height of 135 feet above high water. Figure 1 is a general view of the bridge. From shore to shore the Hudson at

this point is a little over a mile wide. The distance between piers is 2,500 feet, the distance over all, 9,000 feet, the width 100 feet, and, as will be noted, the architectural style is Gothic. The material proposed is granite.

Figure 2 is a drawing to accurate scale showing the relative size of the bridge to the largest ocean-going steamer. The height of the pylon is 308 feet; the symbolic figure, 52 feet.

Figure 3 is a view looking along the center of the upper structure. The roadway for rapidly moving vehicles is here located, while on either side there are east and west bound roadways for slow moving vehicles. There are four transit tracks on this level.

Figure 4, a sectional view, shows the lower level. Here will be located nine tracks for passenger or freight trains, with track connections on the New Jersey side from the various incoming terminals to the warehouse terminals in New York. There are nine railroad tracks on this level.

The map shows, on the New York side, the method proposed to link this bridge with the Brooklyn, Manhattan and Williamsburg bridges. Underground railway transportation along the main business streets of the city, with the most direct "store door" delivery, would eliminate thousands of trucks from the surfaces of those streets and would facilitate both traffic and the delivery of perishable goods.

The estimated cost of this proposed memorial bridge is \$200,000,000. It would require about five years for its completion.



FIG. 5

Christ Church and Graveyard, Philadelphia, Pa.

(See reproduction of original drawing by O. R. Eggers on opposite page)

In a previous issue there was illustrated a view of Christ Church and this is now supplemented by Mr. Eggers' clever sketch of the wall surrounding the old churchyard wherein lie the remains of many men and women who actively participated in affairs during the early period of the formation of these United States.

In the present sketch Mr. Eggers has shown the iron railing set into the wall through which the passer-by may view the grave of Benjamin Franklin and stop to do him the homage of a passing thought. The tomb, a slab of stone set flat, for Franklin was an unpretentious man, bears the inscription "Benjamin and Deborah Franklin, 1790."

Much credit is due the citizens of Philadelphia for their reverential attitude toward these old landmarks, for in no city are they more patriotically cared for.



CHRIST CHURCH AND GRAVE YARD, PHILADELPHIA, PA.
THE AMERICAN ARCHITECT Series of Early American Architecture

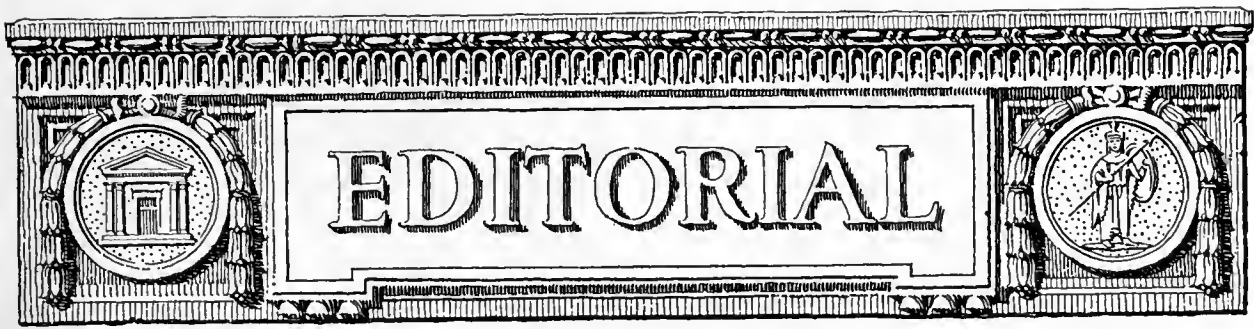

State Registration Fails in Indiana

BASING its action on a disinclination to create further State Boards, the Indiana State Legislature, on second reading, defeated a bill drawn to organize a State registration for architects. Inasmuch as registration has in a majority of states been recognized as essential to the correct practice of architecture, it would seem that the objection to an increase of Boards might have been overcome by the abolishment of some now useless bodies.

The Indiana Society of Architects, nothing daunted by the present failure, has announced its determination to labor persistently to secure State registration, but as the Legislature does not meet again until 1923, the much needed reform is a long way off.

A Timely Resolution by the Illinois Chapter

EVERY man who has been in attendance at conventions of the Institute will undoubtedly have been impressed by the time-wasting methods that have been employed to carry out the convention program.

Debates on reports are, as a rule, purely academic discussions of little lasting effect and serve more to entertain the delegates than to instruct them.

The Illinois Chapter of the Institute at a recent meeting passed a resolution setting forth that it might be advantageous to arrange the program of the May convention so as to devote less time to questions of ethics and the various codes and more to topics that are of present importance and with which architects are today vitally concerned.

The resolution suggests that it would be well to set a time for the constructive discussion, with resultant conclusions of ways and means to better the present highly unsatisfactory conditions in the building industry.

Further, the very wise suggestion is made that commendable and constructive bills pending before Congress under the authorship and guidance of Sen-

ator Calder should be thoroughly discussed with a view to formulating suitable resolutions in favor of the desirable proposed legislation.

Bluntly stated, the Illinois Chapter seeks to direct attention to the usual time-wasting methods at previous conventions, and to suggest one or two of the important matters that might be properly discussed.

Report of Calder Committee

THE report of the Calder Committee should be interesting reading for architects. It shows evidence of earnest work, and the bills that are recommended indicate that a well-directed effort has been made to find a remedy for the present housing shortage.

Poorly considered rent laws, enacted in various States, more particularly in New York, have had a result exactly opposite to that intended. While they have perhaps protected tenants, they really have retarded construction. It is only by reason of prompt and widespread construction that rents will be lowered. Any legislation that restricts consumption by creating distrust on the part of prospective builders is futile.

Many wise provisions are to be found in this report, and perhaps the wisest is that which proposes to untie restrictions that forbid national banks making long-time loans if the borrower would build a house.

Another well considered recommendation is that for a special home banking system which may sell its debentures to other financial institutions.

No one will believe that even the well considered recommendations to be found in the Calder report will, if enacted into legislation, make housing more plentiful or quickly result in a lowering of rents, but there is no doubt that it would largely promote a much desired result.

Government construction, which of course means prevention of private construction, is, fortunately, not recommended. Neither is there a subsidy proposed other than a tax remission.

Withal, the report is an admirable one.

Architectural Management—Part II

By FRANCIS B. ELLIS

Architect with Bethlehem Shipbuilding Corporation

DIVISION OF ARCHITECTURAL DESIGN

Design is the exhaustive process of originating. Somehow the architectural designer seems always to feel this exhaustion more than any of the other classes of designers. This is mainly due, I feel sure, to temperament. Your most difficult problem in organization will be the constant opposition of that element known as the artistic temperament. The only way to deal with it is to understand it and to sympathize with it, but never give in to it in such a way so as to sacrifice business principles. From the point of view of production, the architectural designer is the most important man employed by the firm, as he produces that by which the firm will most often be judged. His work will be under the guidance of the members of the firm, and all those with authority to influence the character of representative production. This designer must understand and personally sympathize with the style and character of architecture representative of the firm's reputation. Sketches are given at the start showing the original thought or inspiration, and his work will be criticised as it is produced—but he must have the authority to go ahead and design with as little loss of time as possible. The point that must be clear, however, is that there are other things as important as pleasing the eye. Never let the architectural designer feel that he can do just as he pleases, he must design for the best interests of the firm as a whole, always. We architects must work constantly to overcome the popular idea that an architect is simply a long-haired black-tied individual who produces picture and plans and nothing much more than that, and that any *Lady's Weekly* can give the same service for a few dollars. Nothing tends more to carry out this popular mistaken idea than to have the architect put too much stress on architectural design and silly little hard-to-understand sketchy sketches—and not enough stress on the business end of the problem. Architectural design *must* be practical, it must be honest, it must not be wasteful—either in time, money, material or labor. A very important consideration is that when the design is once well under way it must be strictly followed. The habit of changing the mind indulged in by so many designers must be stopped. You cannot stop your client from changing his mind if he constantly sees you doing it within your own organization.

The hardest nut of all to crack is that old one which threatens good architecture for the sake of the

client's own personal tastes. It is largely a matter of opinion as to how much the client should have to say about the design of the building, but after all, whose building is it? Who holds the purse? And should not the finished product show something of the individual taste of the owner? are all perfectly fair questions. Therefore the designer should look upon the condition as a condition of the problem—and he should eliminate the bad, save the good and make the best of the indifferent—in other words, tact and diplomacy, two items so often found missing in the make-up of the architectural designer, must somehow be supplied. In short, the designer must understand that he is working for a business concern, on a business basis—that his firm must make a fair profit—and that he must produce a good business investment for the client.

DIVISION OF STRUCTURAL DESIGN

In this department you find as much temperament as in the architectural department, only of a different and not so easily recognized sort. The structural man is constantly very conscious of having about the only man's job there is on the face of the earth, and, above all is he always conscious of the silly, senselessness of (what he calls) architecture; he is willing to allow it to live, it is his gracious condescension which allows that unnecessary, effeminate being, the architect to hang upon the building a few senseless ornaments. This is about the most unfortunate attitude possible, as it does not tend to tame the wildly sensitive feelings of the gentle architect and, consequently, wrecks the team play that must exist in the organization. Fortunately, all structural men are not in this unfortunate condition; some there are who know that order and architecture are terms meaning about the same things, and that a beautiful result is much more likely to aid the engineering solution than retard it.

Some architects prefer having this structural work done outside, using as an argument that engineering problems should be done by engineer specialists. It depends largely on the size of the firm and the kind of work to be handled. You should always be able to handle the ordinary, simple problems of construction, and should have at least one good expert structural designer to advise and aid you throughout all your structural problems. The greatest argument for keeping all this structural work within your Family is that in so doing you are making your concern just

(Continued on page 436)

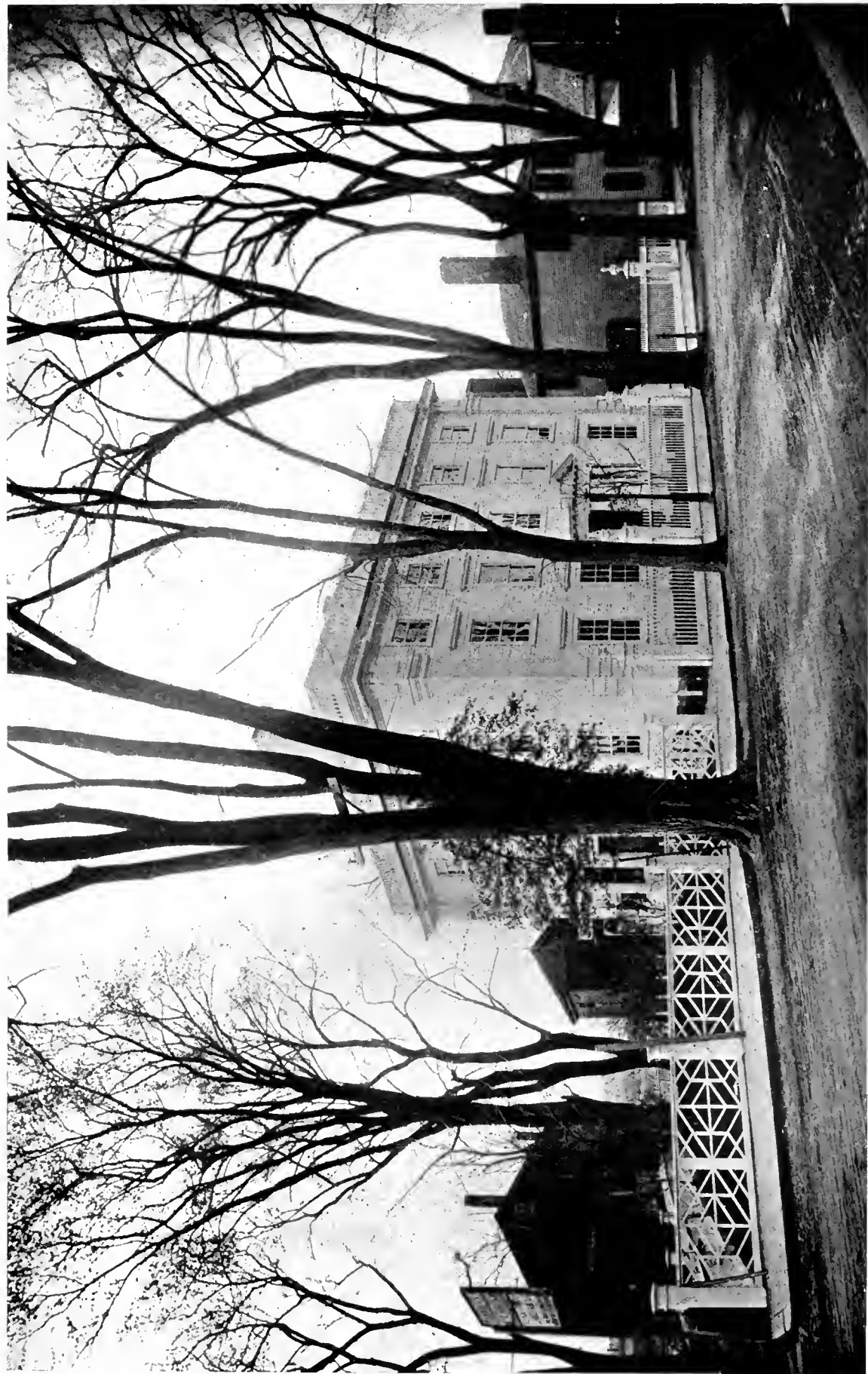

PIERCE-NICHOLS HOUSE, FEDERAL STREET, SALEM, MASS.
SAMUEL McINTIRE, ARCHITECT
ERECTED 1782



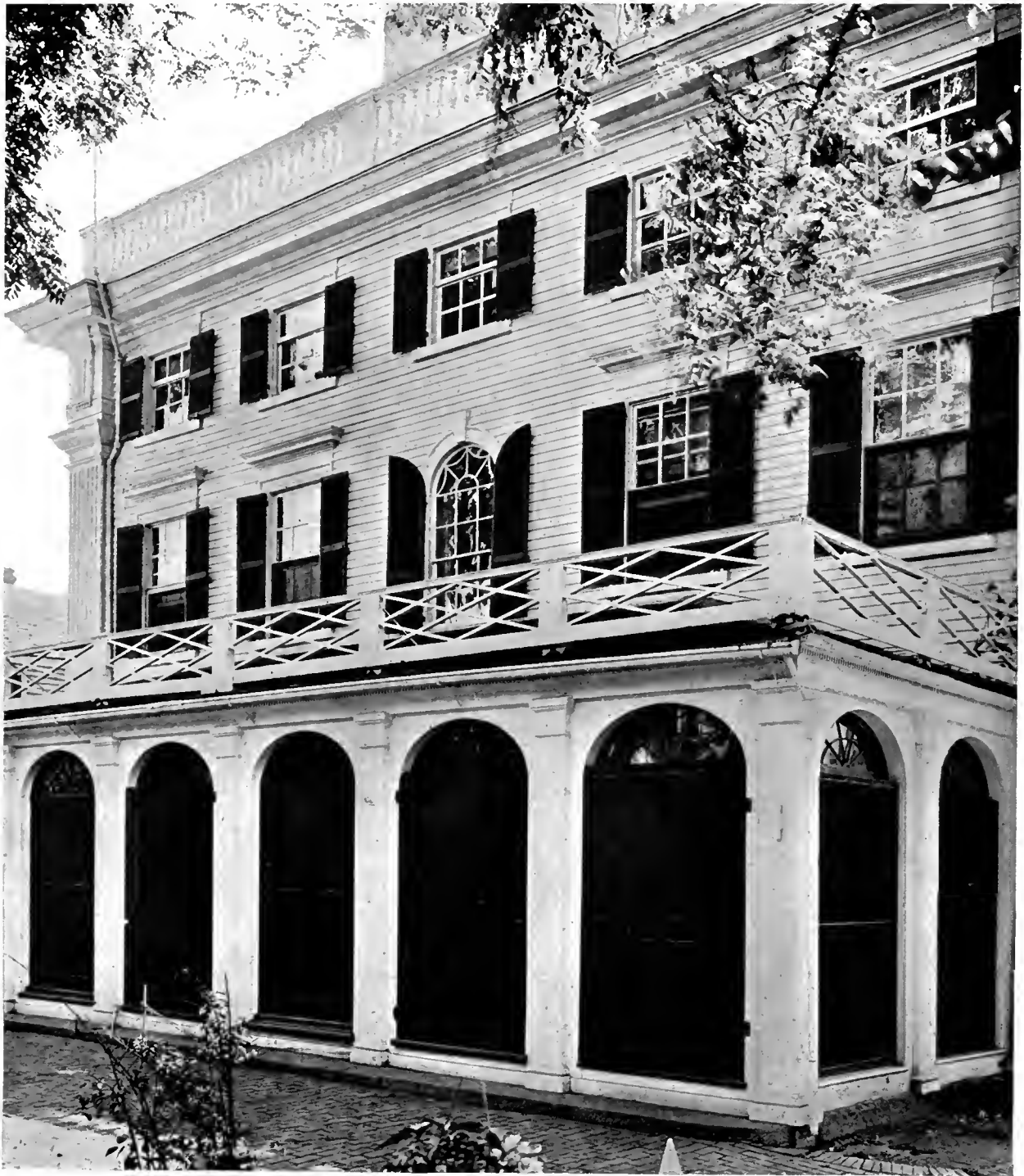

REAR VIEW
PIERCE-NICHOLS HOUSE, FEDERAL STREET, SALEM, MASS.
SAMUEL McINTIRE, ARCHITECT





PIERCE-NICHOLS HOUSE, FEDERAL STREET, SALEM, MASS.
SAMUEL McINTIRE, ARCHITECT
BUILT 1782



DOORWAY
PIERCE-NICHOLS HOUSE, FEDERAL STREET, SALEM, MASS.
SAMUEL McINTIRE, ARCHITECT



HALLWAY, SECOND FLOOR
PIERCE-NICHOLS HOUSE, FEDERAL STREET, SALEM, MASS.
SAMUEL MCINTIRE, ARCHITECT





OLD LADIES' HOME, DERBY STREET, SALEM, MASS.
SAMUEL McINTIRE, ARCHITECT





MANTEL
OLD LADIES' HOME, SALEM, MASS.
SAMUEL MCINTIRE, ARCHITECT







RESIDENCE OF MR. JOSEPH E. TILT, CHICAGO
HOLABIRD & ROCHE, ARCHITECTS





AT LEFT:
DETAIL OF HOUSE OF
JOSEPH. E. TILT
CHICAGO, ILL.

BELOW:
HOUSE OF
LOUIS A. FERGUSON
EVANSTON, ILL.

HOLABIRD & ROCHE,
ARCHITECTS





DEPARTMENT OF ARCHITECTURAL ENGINEERING

A New Building for the Motor Transport Industry

THOSE who are not closely connected with the motor transport business and the automobile industry cannot fully appreciate the extent to which this business has grown in recent years, but nearly everybody did realize the value of this service during the railroad switchmen's strike of last Spring. The manner in which motor trucks moved the necessary commodities was efficient and prevented serious conditions in many parts of the country.

There has been a rapid growth among the individual concerns engaged in this work, but the story of one is practically the story of all. It is significant that ex-Governor Alfred E. Smith (New York) upon the expiration of his term of office last December 31 entered the motor transport service as chairman of the Executive Committee of one of the largest concerns of this nature in the country. Naturally such growth calls for the construction of adequate buildings to house the industry. The Transport Service, Inc., Long Island City, N. Y., has a new six-story building, which was designed by B. H. & C. N. Winston, architects. This building covers a ground area of 75' 1/8" x 100'.

The first structure erected for this company was a one-story garage covering a ground area 38' x 90', and was built in 1917. It was also designed by

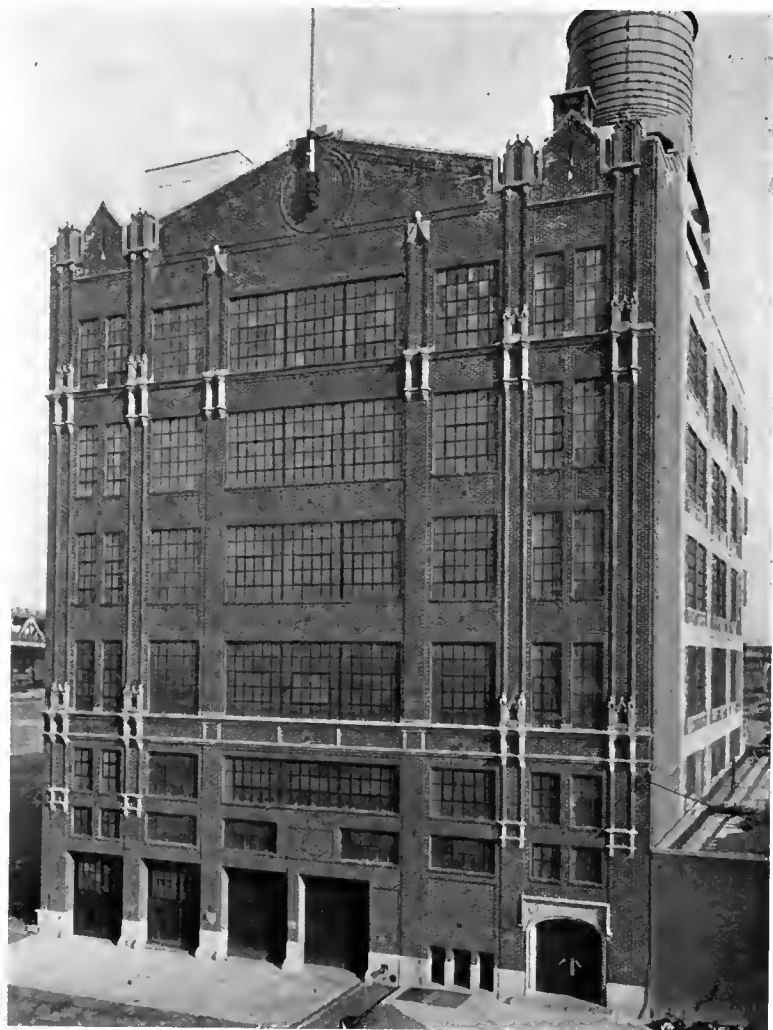

BUILDING FOR TRANSPORT SERVICE CO., INC.
B. H. & C. N. WINSTON, ARCHITECTS

THE AMERICAN ARCHITECT

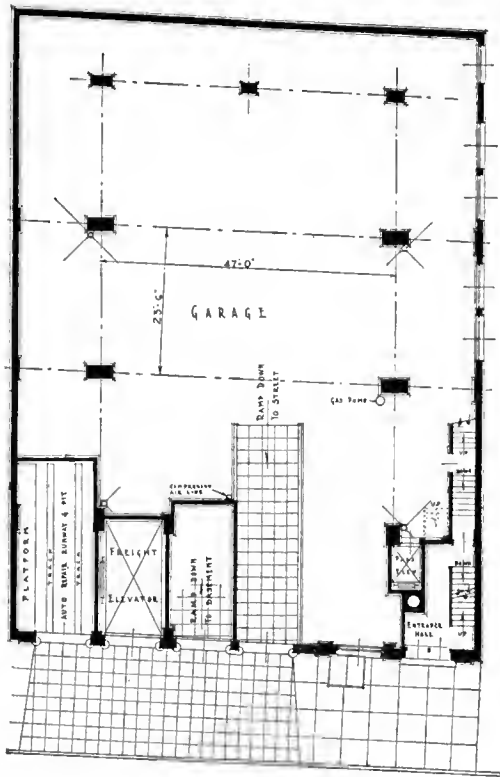

FIRST FLOOR PLAN

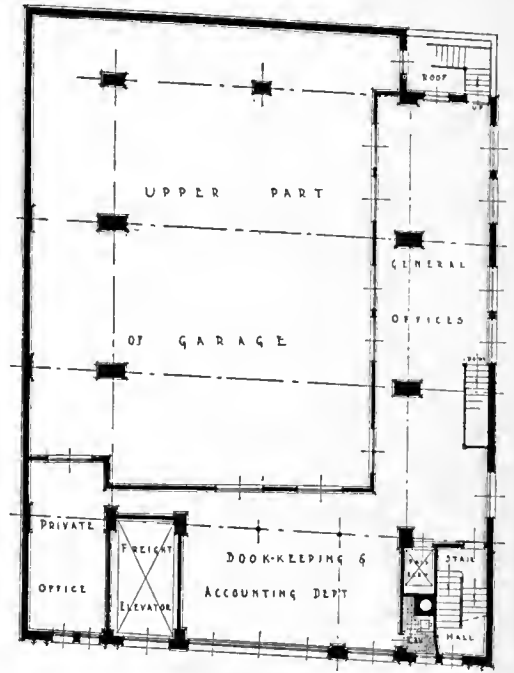

MEZZANINE FLOOR PLAN

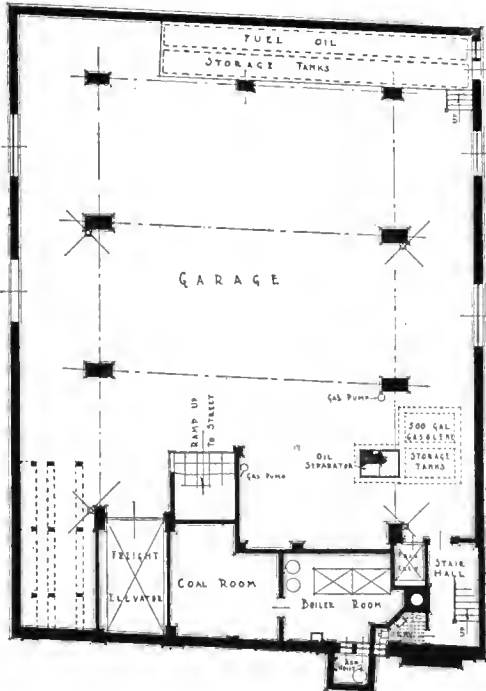

BASEMENT FLOOR PLAN

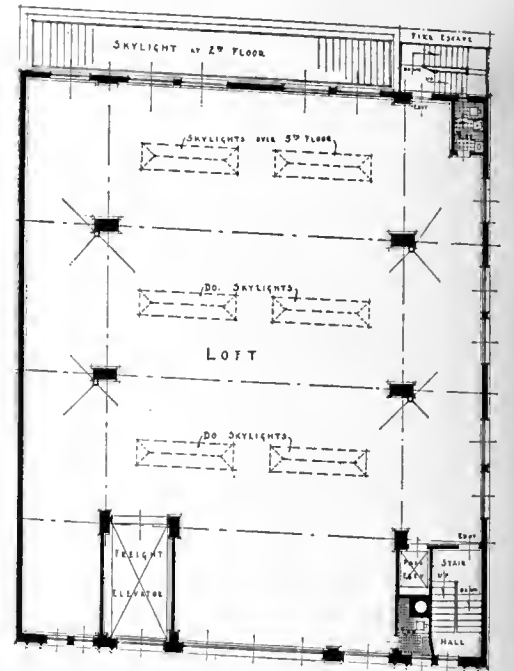

TYPICAL FLOOR PLAN

BUILDING FOR TRANSPORT SERVICE CO., INC., LONG ISLAND CITY, N. Y.

B. H. & C. N. WHINSTON, ARCHITECTS

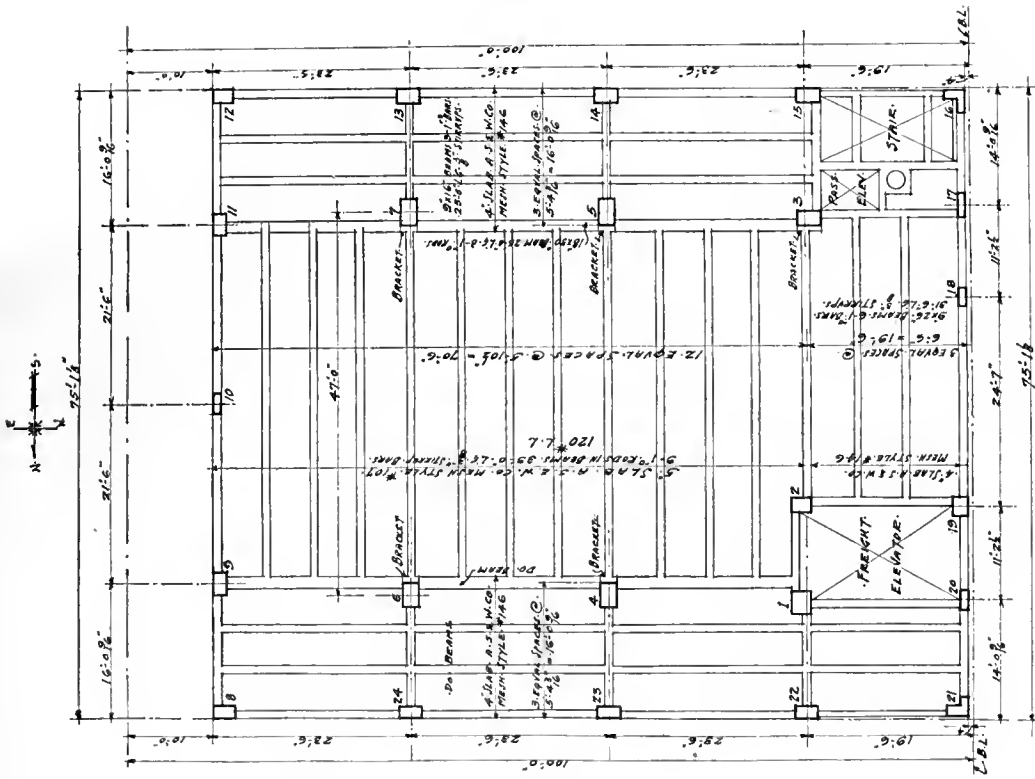

TYPICAL FRAMING PLAN.
SCALE: 3/8" = 1'-0"

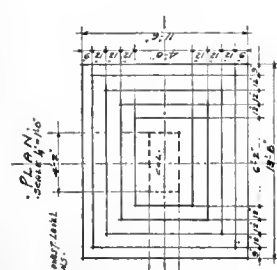

TYPICAL DETAIL OF INTERIOR COL. & FOUNDATION.
SCALE: 3/8" = 1'-0"

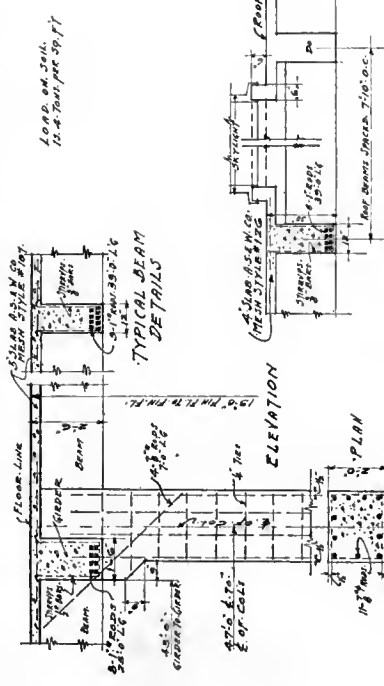

TYPICAL BEAM DETAILS

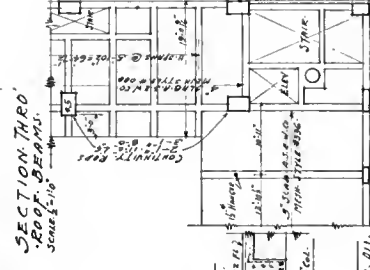

SECTION THRO' ROOF BEAMS.
SCALE: 3/8" = 1'-0"

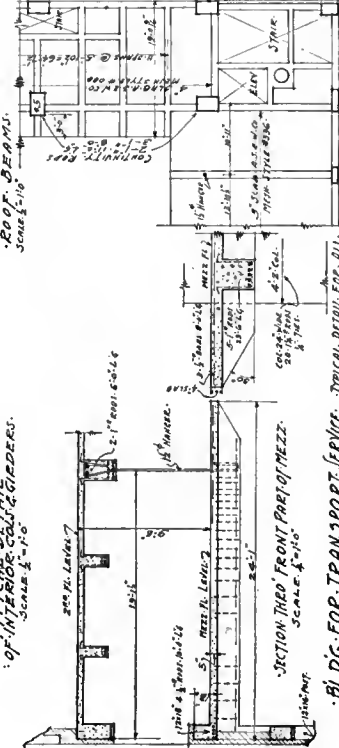

SECTION THRO' FRONT PART OF MEZZ.
SCALE: 3/8" = 1'-0"

BLDG. FOR TRANSPORT SERVICE - TYPICAL DETAIL FOR ALL LONG ISLAND CITY OVERHANGING MEZZ. - BY E.C.N. WINSTON, ARCHT. BEAM SCALE: 3/8" = 1'-0" COLUMN SCALE: 3/8" = 1'-0"

BUILDING FOR TRANSPORT SERVICE CO., INC., LONG ISLAND CITY, N. Y.
B. H. & C. N. WINSTON, ARCHITECTS

THE AMERICAN ARCHITECT

Messrs. Whinston. Since that time the same architects have designed and supervised the construction of a second one-story building at the rear of that just mentioned. This was built in 1920 and covered a ground area of 62' x 90'. A loading platform and despatch building were erected in 1920. In the near

the conduct of the business to be housed sometimes make the use of this type of construction impracticable. This was exactly the case in the building for the Transport Service, Inc.

A study of the floor plans will show that no columns obstruct the central space throughout the building. In fact, the two rows of interior columns are 47 ft. apart. The typical framing plan and construction details illustrate the very unique method by which the span of the beams was reduced to 43 ft., although the columns were kept 47 ft. on centers. This decrease of 4 ft. in span permitted a considerable reduction in the size and reinforcement of these beams. These principal floor beams are 12 in. wide by 30 in. deep and are reinforced with nine 1-in. square rods. They are spaced 5' 10½" on centers.

The longitudinal girders are framed eccentrically into the columns, this eccentricity amounting to 2 ft. In order to eliminate excessive bending stresses in the columns due to such extreme eccentric loading the reinforcement and design of the girder framing into the opposite side of the columns was so carried out as to reduce materially these secondary stresses. These longitudinal girders are 18 in. wide by 30 in. deep with a span of 23' 6", and are reinforced with eight 1-in. square rods. Stirrups are used for both beams and girders.

The floor slab is 5 in. thick, reinforced with American Steel & Wire Company's triangular mesh, style No. 107. The roof slab is 4 in. thick, with a somewhat lighter reinforcement.

The typical interior column is 2' x 4' 2" in cross section at the footing level, is suitably reinforced, and is designed to support a load of 595 tons. A simple stepped-up spread footing is used, the only reinforcement being at the bottom. The load on the soil was computed at 4 tons per sq. ft. The foundation walls are also of concrete, and serve as con-

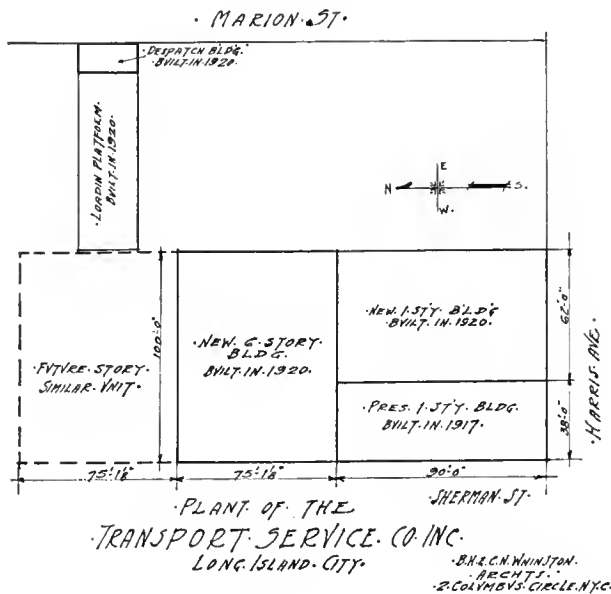

future a second six-story unit similar to the one in this article and north of it is contemplated.

The completed building shows an attractive and somewhat unusual façade for this type of industrial building. The design is an adaptation of the Gothic. A veneer of dark red tapestry face brick in variegated colors is constructed over the concrete framework and securely anchored thereto. This brickwork was moderately ornamented with limestone trimmings. The main entrance has a low elliptical arch and deep reveals, giving a quaint distinction to the building. Vertical lines are brought out in the end bays by laying the brickwork at a horizontal angle. Around the side walls, the concrete frame is hidden entirely for a length of the first column by brickwork. A 35-ft. flagpole has been erected on the front parapet wall, set in a cast iron stand 4 ft. high and fastened to a circular brick panel.

In an article published in *THE AMERICAN ARCHITECT*, February 16, featuring the Loose-Wiles Building, it was stated that while the flat slab type of reinforced concrete construction was being used to an ever increasing extent, certain conditions necessary to



FIG. 1



FIG. 2

tinuous footings for the exterior columns. Solid steel window sash was used throughout.

The general offices, as well as the bookkeeping and accounting department and private offices are located on an "L"-shaped mezzanine in the first story. This mezzanine is hung from the second floor framing as illustrated in one of the construction details, the hangers consisting of 1½-in. round rods hooked over the reinforcing bars of the second floor girder supporting it at the top and also looped around the reinforcing bars in the mezzanine floor construction at the bottom.

The first and second floor levels were located equally distant below and above grade and are served by ramps to accommodate motor vehicles. This tends to cut down the ramp length to about 37 ft. and so conserves floor space. The grade of the ramp was made somewhat less than 19 per cent. to the second floor and 14 per cent. to the first floor and has worked out well in actual use.

In addition to the ramps, a car repair runway, of a type patented by this company, has been provided at the northerly side of the building as shown on the first floor plan. This consists of a standard garage track for motor vehicles, supported on an open structural framework. The runway is at the street level and provides a means of



FIG. 3

access for repairs to the under side of motor trucks located thereon. The building is also equipped with a freight elevator of adequate size to accommodate the larger types of motor trucks, this elevator serving all floors, including the basement. A passenger elevator of the push-button controlled type has also been provided with stops for all floors, including the mezzanine. The building is equipped throughout with a modern sprinkler system. Beneath the basement floor level a buried gasoline storage system has been provided, consisting of two 500-gallon tanks and at the rear of the basement buried fuel oil storage tanks have been installed. The mechanical equipment also includes a compressed air storing and handling equip-

ment. Provision was made for running the supply pipes of the sprinkler system through the deep concrete beams rather than under them. This enabled the architects to conserve headroom, which is so valuable in a building of this nature.

The motor transport system has become a most dependable factor in short-haul transportation. Buildings to serve a purpose similar to illustration will undoubtedly be erected throughout the United States.



FIG. 4

Controls for A. C. Elevator Motors

Different Types of Control Are Used For Different Services. Describing Controls for Car Speed Up to 100 Feet per Minute, from 100 to 175 Feet per Minute and Two-Speed Controls to Enable Cars to Make Accurate Landings

THERE are two principal types of control used with elevator motors, semi-magnetic and full-magnetic. In the former, the reversing is accomplished by a mechanically operated drum-type reversing switch; in the latter, by directional contactors controlled from a car switch installed in the elevator car. Generally, semi-magnetic control is not recommended for car speeds exceeding 100 ft. per min. Both types of control have recently been developed for use with slip-ring and high resistance rotor squirrel-cage induction elevator motors.

A typical four-point full-magnetic control panel for slip-ring type of induction motor is shown in Fig. 1. The panel consists essentially of one safety line contactor, two mechanically interlocked "up" and "down" directional contactors, three accelerating contactors, a hand reset overload relay, a reverse phase relay and two control fuses. The number of accelerating contactors will vary with the size of motor—up to 10 h.p. 3 points acceleration, from 10 to 25 h.p. 4 points acceleration and from 25 to 40 h.p. 5 points acceleration.

During acceleration of slip-ring motors the current peaks are lower with light and average loads than they are with heavy loads, but in elevator work heavy loads are the exception to the rule. If current limit acceleration is employed, advantage cannot be taken of these lower accelerating peaks. In order to gain this advantage, time element acceleration is employed and to obtain this given time interval between the closing of accelerating contactors a flywheel type interlock is used. This consists of an unbalanced free moving flywheel which is released upon closing of the contactors on which it is mounted. This permits the interlock to function, causing the next accelerating contactors to close. The time of operation can be set at approximately $\frac{1}{2}$, 1 or $1\frac{1}{2}$ seconds.

With the movement of the car switch to the first point either "up" or "down," the proper directional contactor is closed, permitting the safety line contactor to close, connecting the motor to the line with full resistance in the circuit. The closing of the safety line contactor releases the flywheel interlock mounted on it, permitting the first accelerating contactor to close. This releases its interlock until the motor has accelerated up to full speed and is run-

ning with no resistance in circuit. The acceleration is automatic.

If the safety line contactor is, for any reason, accidentally stuck in the closed position, electrical interlocks are so arranged as to prevent either of the directional contactors from closing until the safety line contactor is first free.

A reverse phase relay provided with potential coils

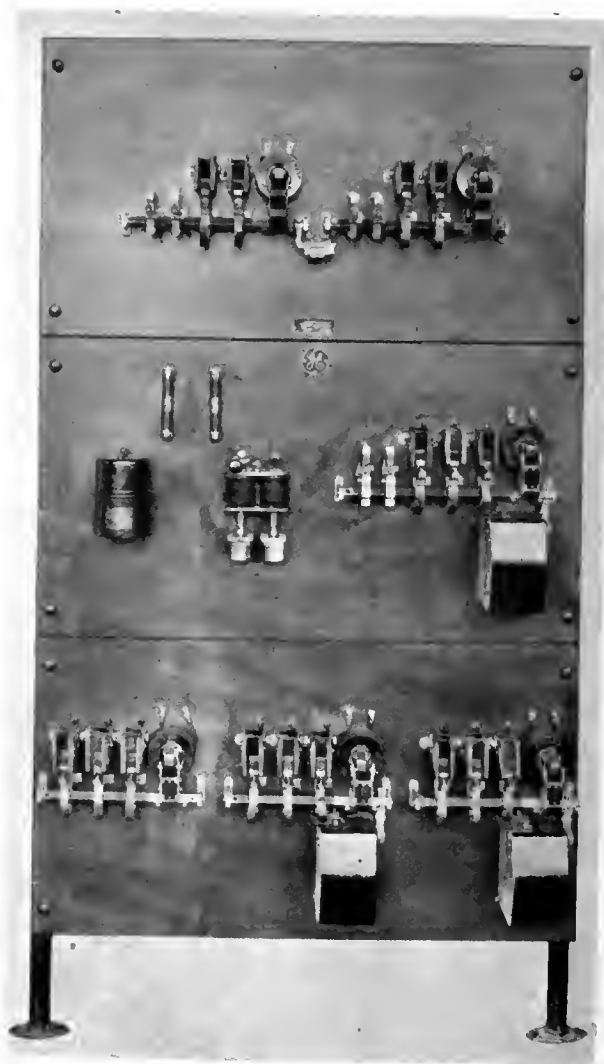

FIG. 1. TYPICAL 4-POINT FULL-MAGNETIC CONTROL PANEL FOR SLIP-RING TYPE INDUCTION MOTOR

is supplied on all polyphase elevator panels. This relay prevents starting the motor in case of phase failure or phase reversal provided the difficulty is not between the relay and the motor terminals. Practically all building codes call for a phase reversal

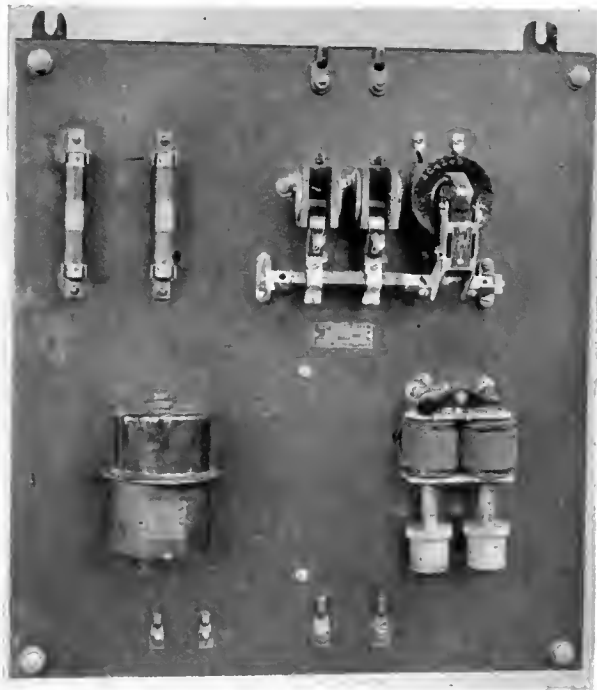

FIG. 2. TYPICAL SEMI-MAGNETIC CONTROL PANEL FOR HIGH RESISTANCE ROTOR SQUIRREL-CAGE MOTOR

relay with potential coils on polyphase alternating current elevator control panels.

The overload relay is of the two coil inverse time element type and protects against sustained overloads but does not trip on the accelerating peaks. The overload relay may be omitted if not desired.

The semi-magnetic type of control panel is similar to the full-magnetic with the exception that a drum-type reversing switch is used instead of magnetically operated contactors for reversing the motor.

A typical semi-magnetic control panel for a high resistance rotor squirrel-cage motor is shown in Fig. 2. This panel consists essentially of a main line contactor, a reverse phase relay, hand reset overload relay and two control fuses and is designed for throwing the motor directly across the line. The reversing is taken care of by a drum-type reversing switch and all braking of the motor is by the contactor tips. The overload relay and the reverse phase relay are similar to those described above.

In the full-magnetic control for high resistance rotor squirrel-cage motors mechanically interlocked directional contactors are used instead of the drum-

type reversing switch. These contactors are electrically interlocked with the safety line contactor to prevent closing in case the safety line contactor is stuck.

Sometimes there is objection to throwing the larger sizes of high resistance squirrel-cage type motors directly across the line. Panels have, therefore, been developed with two-point acceleration for this type of motor. These panels consist essentially of a safety line contactor, two mechanically interlocked directional contactors, and one resistance contactor controlled by a flywheel type interlock mounted on the safety line contactor. When this is closed, the resistor used in series with the primary at starting is "shorted out." On this panel there are also a reverse phase relay, a hand reset overload relay and two control fuses.

This equipment often permits the use of squirrel-cage motors on elevators traveling at speeds from 100 to 150 ft. per min. Speeds as high as these would be undesirable if the motors were thrown directly across the line.

For elevator speeds above 175 ft. per min., and for slower speeds where accurate landing is required, a two-speed alternating current elevator motor is often used. The control for such motors is generally of the full-magnetic type, incorporating the safety features already mentioned.

Walls of Steel About the Louvre

Believing that the priceless treasures of the Louvre museum might prove an irresistible temptation to some of the thousands of undesirable foreigners, bolshevik agents and what not, who have swarmed into Paris in the last few months, the authorities in charge of the nation's art collections have taken precautions on a par with those adopted when the Germans were threatening the French capital.

The guardians of the world's greatest museum of art have not forgotten the daring theft of the Mona Lisa and if they had, the possibility of a repetition of that affair has been brought home to them by the discovery within the last few weeks of at least three would-be collectors of masterpieces at no cost within the sacred precincts after the closing hour.

Therefore, in addition to its solid walls and massive doors, the historic building in the rue de Rivoli is to have a girdle of steel, in the form of spiked fences at the Postern of the Clock, at the gates on the Seine side of the museum and around the archway opposite the Oratoire. To turn the museum into a veritable medieval fortress nothing will be needed except drawbridges which can be lowered to admit duly accredited tourists.

Architectural Management

(Continued from page 428)

so much more broadly architectural—and the concern that does has the advantage over the concern that does not. Often you can combine experts, for instance, the structural designer sometimes can head the material and specification division,—it is often found that the same designer can, under ordinary conditions, handle the work of the division of mechanical and service design. All this will depend largely upon the conditions of business and of the sort of work to be handled—it would be best to maintain the various divisions, however, and be ready at all times to man them for fighting strength.

Structure is a part of architecture, and is of as much importance to the reputation of the firm as any other consideration. Your structure fails, and your architecture has failed. The demands of the structural designer will often require the alteration of some very pet idea of the architectural designer, and it will often be that the structural designer will have to do some special structural design to save some very desirable architectural feature. The laws of pure architectural design are as important as the laws of statics, though perhaps less logical and less understood. Therefore you must have a structural designer who will be proud to do his part toward helping the finished structure to appear well, and to advertise the firm's work from this point of view as well as any other. He and your other designers must work together with free understanding and respect for one another, and must have that perfect team play which must exist for the life and success of the organization.

DIVISION OF MATERIAL DESIGN AND SPECIFICATION

I have spoken of the possibility of combining the duties of this designer with those of some one of the others. I do not consider, however, that this would be at all the ideal thing to do, as the duties of this man will be extremely numerous unadulterated. This designer should be the practical business man, the connecting link between the firm and the outside business world. He must know building law, contract law, and be somewhat of a legal mind. He must follow the markets—the material market, the labor market and, to a certain extent, the stock market, so as to keep informed as to the business outlook. He must keep cost and price records and tendencies, so that he can handle estimates with reasonable assurance. He must file samples and catalogues and keep himself informed on all the most modern methods, processes and materials as to their relative values, uses and merits. He must follow closely the running and overhead expenses of the organization—must keep the books, the diary, the journals—and keep track of

the finances. He must either be a bonded employe, or a member of the firm. It is easy to see that this division will be a very busy one, and one demanding very clear and particular management—with specifications to write records and progress charts to keep to date, and all the study to keep up with the progress of the outside world.

DIVISION OF MECHANICAL AND SERVICE DESIGN

The duties of this division depend largely on the type of work indulged in by the concern. Heating layouts, electric equipments, power plants, elevator installations, incineration, refrigeration, laboratory, and school equipments, plumbing, ventilation, etc., etc.—all come under this department. Oftentimes this work can be taken care of best by outside experts, but, here again it is best if the conditions of the problem can be handled inside the organization—it makes a much better impression upon the client.

DRAFTING DEPARTMENT

Each of the design divisions should have its representative draftsmen, with the exception of the material and specification division. This latter division should be represented by clerks and stenographers, instead of by draftsmen, but these should rate as draftsmen and be classified as the drafting department of that division.

The head of this department should be known as the head or chief draftsman. He must rate as high as the man at the head of the design department and must be considered as important a man as you have in your organization. These draftsmen, clerks and stenographers are to produce, and this department might well be called the production department,—as the other department is called the design department. All that has been said about the designers applies also to the draftsmen. The designers have produced certain original designs, and the draftsmen must carry them out in the original spirit with the least possible delay. The chief designers shall, of course, have full authority to follow the development of the drawings and can request the chief draftsman to do thus and so, with the object of aiding in correct interpretation of the designs. But this overseeing and criticism on the part of the designer should not delay the progress of the work, and the authority for any changing of that which has already been done must come from the chief draftsman. Your drafting room can be arranged to fit your business; it is a good plan to make each draftsman feel himself a part of your organization—each man holding a definite position. As I said before, do not have anything in the dark; give each man to understand what he is for, his value to the system, his chances to advance, what his next position is likely to be, etc., etc. A good order is as follows: chief draftsman, assistant chief, squad chief, assistant squad chiefs, checkers, draftsmen (in order

THE AMERICAN ARCHITECT

of rank), squad clerks, and office boys. Every man should have his understudy, and every understudy should be trained at all times to step into his substitute position at any time. The dividing of the force into squads is like forming teams, and has a tremendous advantage; it is a scheme used in many of the largest drafting rooms.

One point to be remembered in your endeavor to make your organization a unit is that each worker is a part of the whole. The finished result, whatever it is, is the work of one as well as another of the workers. One thing every man has a perfect right to in this world is just credit for what he does—a knowledge that what he does is valued and recognized. When the organization makes a promise to do a certain work and get it done on a certain date, every part of the organization must know that promise and each worker in that organization must feel his share of the responsibility to make good that promise. A job has been contracted for,—the manager and his various chiefs get together and a time schedule is worked out—a reasonable and workable schedule—this is then the promise of the firm, and all are equally responsible for living up to that schedule. After the approved sketches are made, the burden of production, and production on time, rests with the drafting department.

The chief draftsman must be constantly on the job, he must know each man in his department, must follow closely all the work and its progress, give encouragement where it is needed, know where to give credit, and where to place blame. He must not be in any sense either a "floor-walker" or a "pussy-foot," but he must simply be a manager, with direct wires through to the boss, the client, and the outside world. He shall have full power to "hire or fire," and as far as the men in the drafting room are concerned he is boss. The chief shall keep careful records of the value of each draftsman—such points as speed, accuracy, faithfulness, loyalty, punctuality, honesty, neatness, personality, tact, etc., etc., are all means for comparison between men, and it is easy to keep a strictly private comparative record of the draftsmen's ability based on these points. Such a record gives at a moment's notice just who is in line for a raise, just who is in line for demotion, and just who is in line for release. A record such as this shows improvement or decline, and is of particular value in this way. It is well to have it known by all the men that this sort of record is kept, however, as the knowledge does no harm, and as it indicates the desire to deal fairly and equally with all concerned.

It is best, during the period of design, to have one

of the draftsmen on the problem with the designer; thus it can be seen this draftsman will be able to take an active part in the interpreting of the designer's original ideas. This has another advantage: It trains some of your best draftsmen later to take positions in the design division.

Time schedules must be very strictly checked up, certain portions of the work must be finished on certain dates, and progress of the work must be constantly recorded with particular care. Each and every drawing shall have its "due date" and each one must be unfailingly finished on that date. It shall constitute one of the greatest and most serious errors and failures to allow a drawing to run over its "due date," as it is that that shall be regarded as a violation of the company's promise. It must be constantly pointed out that it is no more unreasonable to require a working drawing to be finished on time than a competition drawing. Of course, there will be circumstances outside the control of the drafting department that may demand delay, but in such cases the claim for time extension must be put to the proper authorities at once, otherwise the original "due date" will stand. This time extension can only be granted by those who originated the time schedule. The chief draftsman must at all times keep the business manager informed on all drafting room progress and production data. Drafting room salaries shall be settled by the chief draftsman with the approval of the business manager, but one important point should be understood by all at the start, and that is that raises will only be given at certain definite times during the year. Have it understood that Christmas and July 4 shall be raise dates; on those dates if a man is in line for a raise he will get it, but under no condition at any other time. Of course, business conditions may not always allow the firm to give raises when these dates arrive. In those cases the men must feel themselves thankful for their jobs and pull hard for better times. The advantage of such an understanding is perfectly plain; your men will not constantly be hanging around asking for raises.

Time cards and progress charts are to be kept by each draftsman. A certain amount of this dry systematic recording is good for the men—it develops valuable qualities and offsets some very unfortunate habits too often looked upon as being earmarks of architects.

This is a rambling outline of what I would like to say on this subject, but I feel that it will be enough to show some of the things that I have noted in my travels among some of the largest drafting rooms and engineering organizations in this country.

Of Current Interest

Happenings and Comments in the Field of Architecture and the Allied Arts

Mural Painters Appointed

Mr. Gari Melchers and Mr. E. H. Blashfield have been commissioned to execute mural paintings for the new Detroit Public Library.

Building Officials' Conference

The seventh annual meeting of the Building Officials' Conference will be held in Cleveland, Ohio, on Wednesday, Thursday and Friday, April 27, 28 and 29. Headquarters will be the Hotel Statler. An interesting program has been prepared by Rudolph P. Miller, chairman.

City Plan for St. Paul

A city plan for St. Paul, Minn., has been worked out and submitted to the City Planning Board. Edward H. Bennett and William E. Parsons of Chicago, city planning experts, made the survey and basic plan, which if carried out will make St. Paul one of the model cities of the west.

Architects and Engineers Organize

A meeting of interested organizations was held at the St. Paul Hotel, St. Paul, March 11, to organize the Minnesota Federation of Architectural and Engineering Societies. The conference was called by the Minnesota Joint Engineering Board, and the federation will have a membership of about 1,500.

The constitution has been ratified by ten societies—the Minnesota Surveyors and Engineers' Society, Minnesota Chapter, American Institute of Architects; Minnesota Chapter, American Society of Heating and Ventilating Engineers; Northwestern Section, American Society of Civil Engineers; Engineers' Club of Minneapolis; Engineers' Society of St. Paul; Minnesota Section, American Institute of Electrical Engineers; Minnesota Section, American Society of Mechanical Engineers; Engineers' Club of Northern Minnesota, and Duluth Engineers' Club.

At a banquet in the evening, W. H. Finley, president of the Chicago & Northwestern Railway, spoke on the railway question. Mr. Finley was formerly chief engineer of the Northwestern Railway. Gardner S. Williams brought a message from the Federated American Engineering Societies.

M. I. T. Scholarships

Two scholarships of three hundred dollars each are offered in the scholastic year of 1921-22 for special students in the fourth year of the course in Architecture at the Massachusetts Institute of Technology. They will be awarded as the result of a competition in design under the direction of the Committee on Design of the Department of Architecture.

The competition is open to citizens of the United States of good character, who are between twenty-one and twenty-eight years of age, and who have had at least three years' office experience. Competitors must, however, present satisfactory evidence of a knowledge of descriptive geometry.

The competition will be held in July, 1921. Competitors are allowed to prepare their drawings wherever conditions conform to the requirements of the Committee, but these drawings must be sent to Boston for judgment.

Applications should be received before May 1, addressed to Professor William Emerson, 491 Boylston Street, Boston, Mass.

Highest Bridge for U. S.

Proposed Structure in Colorado Will Set New World Mark

Plans and specifications have been completed by a Denver steel company for the construction of the highest bridge in the world. It will be a suspension foot and burro bridge and will span the gateway to South Boulder cañon at Eldorado Springs.

The bridge will be 600 feet high and will be erected at a point still indicated by a swinging wire between the two cañons across which Ivy Baldwin used to walk for the entertainment of tourists several years ago. On the north side of the cañon the cliffs rise over a thousand feet. On the south of the cañon Castle Rock Cliff rises 650 feet. The bridge will be suspended in the air about 600 feet, owing to the topography of the cleft forming the gateway, but even at this height it will eclipse any other high bridge in the world.

Other famous suspension bridges that will be eclipsed by the Colorado bridge are the Firth of Forth at Queensferry, the Crumlin railway viaduct in South Wales, the famous London, Niagara Falls and Brooklyn bridges.

Carnegie Institute

International Jury for the Twentieth Annual International Exhibition This Spring Announced

Announcement is made by John W. Beatty, director of fine arts at Carnegie Institute, of the international jury of selection and awards for the coming annual international exhibition of paintings at Carnegie Institute, which will open April 28. William Nicholson and George Clausen, two of England's foremost painters, have been elected as the foreign representatives on the jury. The American artists elected are Charles H. Woodbury of Boston, Mass.; Bruce Crane of Bronxville, N. Y.; Edward W. Redfield of Center Bridge, Pa.; Leonard Ochtman of Cos Cob, Conn.; Daniel Garber of Philadelphia, Penn.; George W. Bellows, Emil Carlsen and Charles W. Hawthorne of New York. These artists, all of international reputation, have been selected by the painters invited to contribute works for consideration for the coming exhibition. The jury will meet in Pittsburgh on April 7 to select the paintings to be exhibited and award the honors. Under an established rule, John W. Beatty is president of the jury. A gold medal, a silver medal, and a bronze medal, carrying with them respective prizes of \$1,500, \$1,000 and \$500 will be awarded.

For the past twenty-four years, with the exception of the period of the war, these juries, consisting of men recognized as authorities throughout the art world both in this country and abroad, have met in Pittsburgh to select the paintings that grace the walls at Carnegie Institute.

The fact that the Annual International Exhibition at Carnegie Institute is the only international exhibit held in this country makes it of signal importance to artists and those interested in art, for it is here that an opportunity is given to compare the work of European and American painters.

Consignments of paintings are arriving daily at the Carnegie Institute. Over two hundred foreign canvases have already been received from England, France, Belgium, Holland and Denmark, and shipments from Italy, Spain, Switzerland and Sweden are now on the way. All indications would point to the Twentieth Exhibition upholding worthily the high standard of excellence set by its predecessors.

Teacherages Are Gaining Favor

Consolidated school districts in Itasca county, Minnesota, are building homes for their teachers. Because teachers in many districts found it impossible to find places to live, the authorities have erected cottages, fitting them for use and renting them at a moderate rate during the school year. With

consolidation growing in favor in Chippewa and Yellow Medicine counties, it is possible that a similar plan may be adopted in this part of the state. The erection of "teacherages" in many towns is also being considered.

These cottages in Itasca county are usually erected on or near the school grounds. One district has built a six-room home which is connected with the school heating plant. Two other districts have built four-room homes. The teacherages are equipped with all the necessary furniture by the school authorities, but bed linen, towels and the like are furnished by the teachers.

Memorial Plans

Architects Asked to Compete for Legion Headquarters Design

Architects from all over the United States will be invited to submit designs for the \$15,000,000 Indiana war memorial building which will house the national headquarters of the American Legion, the national executive committee announced recently. A fund of \$100,000 was appropriated by the Indiana general assembly for prizes and expenses of the contest.

The American Institute of Architecture will determine the winner of the first prize of \$50,000. The State war memorial commission, of which Postmaster General Will H. Hays is a member, will meet next week to open the contest.

Convention of the American Federation of Arts

The Twelfth Annual Convention of the American Federation of Arts will be held in Washington, D. C., May 18 to 21. The sessions will be held in the auditorium of the Corcoran Gallery of Art wherein at the same time will be shown under the auspices of the Washington Society of the Fine Arts the notable collection of British Arts and Crafts selected and brought to this country last autumn by the Detroit Society of Arts and Crafts. In the National Gallery at the time of the Convention will be exhibited the important group of nineteen portraits of leaders of the allied countries in the World War by eminent American painters, which opened in the Metropolitan Museum of Art in January and is reviewed elsewhere in this issue.

It is several years since a convention of the American Federation of Arts has been held in Washington, the National Capital, owing to untoward war conditions. Plans are being made to insure the success of the meeting, and it is hoped that there will be a large and representative attendance.

Weekly Review of the Construction Field

With Reports of Special Correspondents in Regional Centers

Civic Work Progressing

Since the national housing conference, held in January by the Civic Development Department of the National Chamber of Commerce, considerable progress has been made.

Housing surveys have been undertaken by S. G. Lindholm, and other work is definitely in mind. This includes immigration and citizenship and education, in preparation for which careful studies are being made. Dorsey Hyde, Jr., the assistant manager, is aiding in these and is in addition Chief of the Bureau of National Civics, to which come questions having to do with federal government activities.

Survey of Housing Companies

A Digest of Plan and Operation of More Than Two Hundred Local Chambers of Commerce

Belief on the part of prospective buyers that the high costs of houses cannot be maintained in a falling market is given as one of the main reasons why housing companies have encountered difficulty in trying to dispose of new houses during the past six months, according to information gathered by the Civic Development Department of the National Chamber. This department has just completed a survey of more than two hundred local chambers of commerce interested in stimulating house building for the purpose of finding out their plan of operation, and the difficulties they are meeting with in their effort to build more houses.

The "slack" in employment is another reason attributed by these housing companies, which are sponsored by local chambers of commerce, for the slump in the real estate market. The survey shows that some of these companies are willing to sell immediately at a sacrifice, others anticipate only a temporary slump, and are holding the houses or renting them awaiting sales.

The survey shows that fifty-seven housing and financing companies started or completed the building of 5,714 houses, and made plans for building 1,000 more. In fifty other cities no housing companies have been created, but in many of them the local chamber of commerce has in various ways encouraged and facilitated private building. The paid-up capital of the forty-eight companies returning figures on the subject amounts to \$11,863,141.50

Building in Chicago and the Middle West

(By Special Correspondence to THE AMERICAN ARCHITECT)

CHICAGO, April 2.—As spring advances it is becoming more nearly possible to make prediction as to the extent of building which will be observed in Chicago this year. There are constantly multiplying indications that the apathy in regard to building is being gradually broken up and that building, at least on a moderate scale, will shortly be resumed. It is not believed, however, that the building boom will reach its greatest height during the spring and summer of this year. A number of things are combining to make this rather out of the question.

As has been repeatedly stated in these reviews of Chicago activity, there is still a considerable doubt in the mind of the public regarding the rock-bottom nature of present prices, and until the public is convinced that lumber, labor and other essentials of construction are not going to be any lower, building will not reach the magnitude which the housing shortage makes easily possible. This doubt as to price bottom is held by all classes, from the wealthy capitalist to the small prospective home builder, and that the architects themselves hold a similar view may be judged from the very interesting controversy now being waged between the architectural interests and the lumber interests in this city.

The argument arose over a statement given to the press by F. E. Davidson, president of the Illinois Society of Architects, in which it was remarked that present lumber prices are at least 150 per cent. above the 1914 level. The statement was vigorously challenged by N. A. Mather, president of the Lumberman's Association of Chicago, who maintains an average increase of only 64 per cent. as compared with pre-war values in lumber. Mr. Mather offered a contribution of \$1,000 to be awarded to charity if the statement given out by Mr. Davidson could be substantiated before an impartial committee. The Illinois Society of Architects has accepted the challenge and the work of preparing data is now under way and will shortly be presented to the committee.

The subject under controversy and the nature of the argument are very naturally of interest to the profession and to the lumber trade, as well, but the publicity given the two sets of figures has been so great that the public is willing to believe, now, almost anything regarding inflated building values, and there seems little doubt that further hesitation will be the

THE AMERICAN ARCHITECT

result of the debate, regardless of how the matter ends.

Another thing that is arousing doubt in the public mind is the investigation being conducted into local building conditions by a joint legislative committee from Springfield. The newspapers have been pretty well filled with reports of this investigation and facts thus far brought out are not at all favorable in their impression upon the mind of someone who has building on the brain. That there has been gouging back and forth is not now questioned.

These are negative influences in the building complex, but happily enough there are more and better forces at work on the optimistic side of the situation.

One of the very potent ones has been the "Own Your Home Exposition" in progress at the Chicago Coliseum. The attendance at this exhibit has been so great that even the promoters of the exposition have been agreeably surprised. The exhibits, all of them very interesting, have been designed for the express purpose of stimulating the home-owning impulse, and indications are that the purpose is being accomplished.

There is a continuance of the improved condition in the building permit department of the city hall. March reports, not yet tabulated, will show a considerable gain over February of this year and over March of last year. This, too, in spite of the fact that much of the building now going forward is being reported in suburban locations which are not tributary to the city building department and which require no city permit.

Riverside is one of the suburbs to report greatly increased building activity. Some two hundred houses are in course of construction in that aristocratic and populous suburb. There will be a great variety of architecture and materials in these houses. The general plan is to build houses that will sell from \$8,000 to \$11,000. More than 150 of the houses are being erected on the McCormick estate in that suburb.

Perhaps the most important building announcement from the architect's point of view is that recently made by the University of Chicago. President Harry Pratt Judson has sent out a booklet to the alumni of the Institution outlining the building plan which the university board has in contemplation. The immediate expenditure of \$15,000,000 in university construction is now being considered. One of the most imposing of the new buildings will be the Rockefeller chapel, to cost \$1,500,000. Bertram G. Goodhue, the architect of the chapel, has designed a Gothic edifice of Bedford stone construction, with a tower that will rise 216 feet above the street level and will be the dominant architectural note of that splendid group of university buildings. The new building plan contemplates the construction of some

of the new buildings on the south side of the Midway. At present the university group is clustered on the north side of the Midway only. Ultimately, the university buildings will line both sides of the Midway for three-quarters of a mile.

Chief of the buildings to be erected on the south side of the Midway will be the Albert Merritt Billings Hospital, at a cost of \$1,000,000. Other buildings in contemplation are a new theology building, a dispensary, president's house and a new Quadrangle Club building.

The city of Chicago is also to be an important figure in construction work within a short time, if present plans do not miscarry. The Board of Education has a building program involving the construction of twenty-two new school buildings, at an approximate cost of \$25,500,000. Construction of at least ten of the buildings will be commenced this summer if the bids are not too high. The program calls for the twenty-two new schools within three years. Eighteen of the buildings are to be for elementary schools and are to be erected at a maximum cost of \$750,000 each, while four are to be high school buildings, to cost \$3,000,000 each.

Another note indicating early action is an announcement that work is to be undertaken at once in tearing away present buildings on the site at 8-16 North Clark street to make way for the fifteen-story Union Liberty Building which is to be constructed at a cost of a million dollars. Walter Ahlschlager designed the building.

Lumber and material prices remain at about the old levels and it is now generally believed that no general adjustment of prices will take place until building demand is much keener than at present. This is the view taken by lumbermen now in Chicago attending the annual convention of the Wholesale Lumber Dealers' Association and the annual gathering of the American Lumber Manufacturers' Association.

The present price schedule is about as follows:

Yellow Pine: B. & B. 1-in., \$95 to \$130, depending on thickness; 2 x 4, No. 1, 10 to 16 ft. length, \$51 to \$53; 2 x 6, \$48; 2 x 8, \$50; 2 x 10, \$53; 2 x 12, \$55; 13-16 x 3¼ z & b flat flooring, \$85 to \$90; 1 x 6, No. 2 common, \$48 to \$90. *Douglas Fir:* 2 4 S, in sizes up to 12 x 12, in length up to 32 ft., \$65 to \$70; 14 x 14, \$68 to \$73; 16 x 16, \$72 to \$75; 18 x 18, \$75 to \$80. *Hard Maple:* Four, ¼ No. 1 and 2, \$135; select, \$120; No. 1 common, \$100; No. 2 common, \$65; No. 3 common, \$32. *Birch:* Four ¼ No. 1 and 2, \$160; select, \$133 to \$138; No. 1 common, \$95 to \$100; No. 2 common, \$60 to \$65; No. 3 common, \$40. *Red Gum:* Four ¼ No. 1 and 2, \$150; No. 1 common, \$90 to \$92; No. 2 common, \$45.

Face Brick—Standard, vitrified red, \$32.00@

34.00; Smooth, Indiana red, \$38.00@40.00; Smooth, Ohio red, \$38.00@40.00; Smooth, Pennsylvania red, \$46.00@48.00; Smooth, buff, \$45.00@47.00; Smooth, gray, \$47.00@49.00; Rough, buff, \$44.00@46.00; Rough, gray, \$47.00@49.00; Variegated, rough texture, \$34.00@49.00.

Common brick, \$13.00 to \$16.00 per M. Portland cement, \$2.25 per bbl. Torpedo—Lake and bank sand, \$3.50 per yd. Crushed stone, gravel screenings, \$3.50 per yd. Hydrated lime, Ohio, paper, \$21.00 per ton. Hydrated lime, Ohio, cloth, \$29.00 per ton. (Includes sacks at 30c. each.) Hydrated lime, Wisconsin, paper, \$19.00 per ton. Bulk lime, \$1.65 per ton.

The Building Situation on the Pacific Coast

(Special Correspondence to THE AMERICAN ARCHITECT)

SEATTLE.—Employment conditions on the Coast are showing an improvement. The demand for metal is increasing in the lumber mills and building work, and all the larger cities of Washington are able to report a considerable reduction in the number of idle hands. While the change is not showing in heavy jobs, building over this State is increasing, and the only obstacle to a still further reduction of unemployment is that skilled mechanics will not work at a lower wage, and the deflation process must go on until normal conditions and a proper attitude between building labor and investors is attained.

Sheet metals used in construction work are steady and stocks considerable over normal, due to the fact that the mills would permit no cancellations, and the stock continues to arrive. It may be said that several of the houses on the Coast are overbought on sheets and pipe due to the rule at the mills. There is plenty of all sizes of pipe, brass and copper ware used in building equipment. Aside from the decline of half a cent in brass, as of March 9, there have been no fluctuations in brass or copper.

While sheet metals are \$5 base, jobbers on the Coast say that if business were offered to the independent mills and the specifications were suitable, quotations of \$4.75 could be secured. The situation has reached a crisis, according to jobbers here, in the respect that independent mills are evidently waiting to see what the corporation group will do, whether they will reduce or stand firm, but that some radical change is at hand is the impression of Coast jobbers.

There is no scarcity in any essential of building on the Coast today. All the cement plants are in operation and pending extensive hard-surfaced road construction extending all along the Coast a surplus is being accumulated. Roofing is growing more plentiful, but nothing is being done of a speculative nature. Similar conditions prevail as to plaster board.

The week has shown no deviation in fir lumber prices or conditions. Eastern buyers are waiting for the full effect of the rail rate reduction of March 31 before ordering, but it seems to be the feeling that fir lumber has struck bottom and that there would be no advantage in delay further than what may be gained on the lower freight rates. Wholesalers complain of badly broken stocks of flooring, ceiling and finish at the mills, for despite the heavy stocks that accumulated during the dull winter demand it is a fact that uppers or finishing sizes are scarce and stronger.

Average sales at the mills by the mills was in support of the assertion that the market is steady. No. 2 vertical grain flooring averaged \$49, with No. 2 slash grain stock selling at \$20 to \$24. Ceiling was \$18.50 to \$23 and drop siding moved on the average at \$25. Boards and shiplap sold at \$12.50 to \$13.50, common dimension at \$11.50 and plank and small timbers at \$16.50. The shingle market is slightly stronger.

Approximately 75 per cent. of the fir mills in what is technically known as the West Coast territory, consisting of Oregon, Washington and British Columbia, will be in operation early in April. Further confidence in the market is thus indicated on top of reluctance of the large mills to sell at this level.

A close survey for the week among architects, contractors and jobbers of building hardware and lumber dealers accentuates the impression that high labor costs alone stand in the way of active construction operations. Investors are unwilling to pay carpenters \$6.40 per day, and many have openly said that before they will do so their plans must lay over into 1922, when pre-war normal conditions and activity in every line are expected.

The remainder of the construction year of 1921 will show steady improvement. There is more confidence on the Coast than at any time in more than six months. Jobbers have passed on all price reductions as fast as received to the retailer, who in his turn is more inclined to help by passing the additional profit on to the consumer.

442^a

frontispiece to No 2364



RAVENNA, ITALY

THE AMERICAN ARCHITECT

THE AMERICAN ARCHITECT

VOL. CXIX

WEDNESDAY, APRIL 13, 1921

NUMBER 2364



COSMOPOLITAN STATE BANK BUILDING, CHICAGO
RICHARD E. SCHMIDT, GARDEN & MARTIN, ARCHITECTS

Fashionable Architecture

The Cosmopolitan State Bank Building, Chicago, an Unfashionable Example

FASHION, by the power of its influence, is an important factor in the practice of architecture. To some extent it influences everything that is produced from designs and also such products as fiction, poetry and music. The fashions which control raiment, fiction, poetry and music are freakish at times and because they are of such an ephemeral nature they are easily put out of sight and hearing, then out of mind. The majority of

men of whatever occupation, are controlled largely by fashion—their ready compliance makes fashion possible.

When fashion is an element of architectural designing, it becomes a serious matter. There is nothing ephemeral about a well constructed building, its permanence and constant presence are properties of its architectural influence, such as it may be. The various architectural revivals that have passed out

THE AMERICAN ARCHITECT

within the last half century are easily identified. They may have been necessary during our undeveloped period of architectural knowledge. In that half century knowledge concerning architecture has kept apace with engineering knowledge pertaining to construction. There is less excuse today than ever in our history to tolerate an architectural revival or blindly follow the leadership of a fashion.

closely as their limit of cost permits. Many architects, lacking the quality of leadership, readily yield to the leadership of other architects or to the desires of the client and the fashion is established.

This situation will change when bankers, as a group, are educated to the idea that their buildings should be more individual in character rather than a mere unit in a small army uniformly accoutred.



MAIN BANKING ROOM, LOOKING FROM ENTRANCE

Many architects find themselves hampered in architectural expression through the demands of a client who is disposed to accept the transient vogue. This is particularly true of the modern bank building. In every village and city the modern bank building is easily identified. It has become a type, standardized and stereotyped. This type originated in the erection of some buildings notable as to size, cost and careful conformity with some classic precedent which was originally built for an entirely different purpose and ages before the modern banking system was developed. The reputation of the bank and possibly that of the designers, influences other bankers either to surpass the example or to imitate it as

There is certainly the architectural ability available successfully to accomplish this.

The Cosmopolitan State Bank building, in Chicago, is a fine example of unfashionable bank designing. The feeling or knowledge of its purpose emanates from the building and that is the true test of architectural expression. It does not follow that this building should be imitated to secure the same expression because architecture possesses a multitude of voices with which to express, equally well, the same idea.

The keynote of the exterior design is good brickwork used in large, unbroken areas. This is particularly true of the principal elevation which has only

THE AMERICAN ARCHITECT

one, the entrance, opening. This entrance is strengthened in effect by placing the two columns within the opening rather than by projecting them boldly beyond the face of the wall. It is in the larger south elevation that the windows are placed. These are designed to admit the necessary light to the interior, but are so shaped and placed that the elevation possesses a good proportion of window and wall area.

buff Bedford stone, rubbed surface, and harmonize with the brickwork in a satisfactory manner.

The interior is extremely simple, almost severely plain in treatment, yet very pleasing and as far removed from the usual heavy, ornately beamed, corniced and pilastered interior as is possible. The only ornamentation on the walls is the corbels at the spring of the grained ceiling. The panels about the skylight in the ceiling are very low in relief and



MAIN BANKING ROOM, LOOKING TOWARD ENTRANCE

There are no heavy projections, and this fact gives a feeling of stability and resistance which a bank should possess. The lack of heavy shadows is compensated for by the juxtaposition of the two materials used in the walls. The brick areas are large and unbroken, faced with a tapestry brick laid in alternate courses of headers and stretchers directly over the center of the header below. An uncolored mortar laid in fairly wide, flush-struck joints was used. The brick has a rich brown color, the headers apparently being a shade lighter than the stretchers.

The walls present a rich, lively appearance either in the sunlight or in shadow. The trimmings are of

made by unmoulded offsets. The walls are gray with very light shade of green, the ceiling is gray with shade of cream and the ceiling lights are painted a medium dark green. The woodwork, doors, window trim, paneled wainscoting, the base pilasters and cornice of the bank screen are made of walnut. This is finished with a stain, a filler of white lead and two coats of wax. The white filler has the effect of lighting what otherwise might be too dark a finish and brings into relief the very delicately moulded and carved panels. The floor of the public space is paved with Carthage marble; the base and counter-top are of black and gold marble and

the dado of Wellington gray marble. The metal work of the bank screen is very plain, finished in black. The plan comprises all those features common to a well appointed bank. The wrecking of the buildings on the site was begun May 1, 1920, and the building occupied December 18, 1920.

This building impresses one as being very well and carefully studied in all of its parts and details;

in operation it serves its purpose and in design a distinct departure from the accepted fashionable bank building of today. The designer was unafraid to use large, unbroken wall surfaces both interior and exterior, simple and severe lines, rich and neutral colors; and at the same time produced a beautiful and satisfying building.

A. T. N.

Architectural Interiors of the United States Shipping Board S. S. "Hawkeye State"

By FRANCIS B. ELLIS

DURING the war, included in the program of naval construction, were nineteen (19) Troop Ships described somewhat as follows:

Length over all.....	535'0"
Moulded Breadth	72'0"
Designed Draught	30'0"
Displacement	20,800 tons
Shaft Horse Power.....	12,000
Max. Required Speed.....	17½ kts.

These boats were designed by U. S. Naval experts—and show the strong naval influence, being quite unlike the ordinary run of merchant ships. They have great sweeping, flaring, overhanging bows, like great destroyers—and their engine and machinery layouts are quite typical naval design and practice.

Before any of these vessels were much more than well started, the war came to an end, and it was then the desire of the authorities to convert them into something more useful than Troop Ships. It was natural therefore, that it should have been decided to make combined cargo and passenger ships of them—convertible back into Troop Ships in case of war. After the determination of this action these vessels were placed in the hands of the United States Shipping Board to be constructed and operated under the auspices of that body.

The problem was an exceedingly interesting one, as it was unique and original—there being no precedent for vessels of this type. Passenger ship design was, in itself, a comparatively new undertaking on this side of the Atlantic. To be sure there have been some very fine ships designed here—but they could almost be counted on the fingers of one hand, and they were for the most part "cut and dried" designs, taken from what might be classed as "Pullman Car" style of architecture. It was determined at the start of work on these ships that a departure would be taken, and that these ships

would not contain "Ginger Bread" but that they would be simple—and express a domestic feeling. In the preliminary study—German, French and British passenger ships were visited and all fully studied, but, to a large extent "what *not* to do," was the most evident result. "Ginger Bread" ornaments—great massive display of vulgar wealth and imperial splendor of the "Gilded Order" were objects which called up from the architect's point of view, mingled feelings of disgust, nausea, and ridicule.

So, the slate was washed clean, and it was determined that we would start fresh, and design our vessels as American—and that we would express throughout, Democracy, as against Imperialism, paintings of God and man as against portraits of Emperors, Kings and Monarchs.

TWO things were at once settled—First, that all passengers should enjoy the same equal public privileges—all should be First Class. Secondly—the architectural style should be Colonial, because of its simple character and its American development. There would be, of course, a varied assortment of state-rooms—some accommodations more costly than others; in this way the various sizes of passenger pocketbooks could be properly taken care of. Private suites with sitting rooms, bed-rooms and baths; some *real* rooms with *real* beds and private bath-rooms, with all the most modern plumbing fixtures; some state-rooms smaller and with bath-rooms having no bath tubs, but a modern shower bath, some with no private bath-rooms, but with public baths conveniently located, and some with no beds, but with the old "ship's practice" berths, one over the other.

The steel framing of these vessels, and the hull itself were all designed and under construction; boilers, engines and various machinery were located and

THE AMERICAN ARCHITECT



STAIRWAYS, PUBLIC HALLS AND LOBBIES

Staircases were designed easy and wide with simple, turned and carved balusters, sturdy hand rails and sweeping ramps. The color scheme is mahogany and white, and the effort was to carry out faithfully the Colonial feeling throughout. Very few ornaments are to be found, and the mouldings are extremely simple.

INTERIOR VIEWS, U. S. SHIPPING BOARD S.S. "HAWKEYE STATE"

THE AMERICAN ARCHITECT

being installed at the time of introducing the passenger accommodations. The architect was obliged to take things very much as he found them, and to put his "architecture" about the structure, piping, vent ducts, and mechanical contrivances which were found cluttered about here and there. Certain alterations to the hull were allowed, for instance; the addition of grand staircases, a more elaborate heating and ventilation system, added and complicated plumbing installations, all introduced positive demands that had to be recognized.

The planning on these ships, the getting out drawings and specifications was in no way any different from the same work on a building. First, small scale sketches and plans, then $\frac{1}{4}$ " scale general ar-

range ment working drawings. After these were complete and approved, $\frac{3}{4}$ " scale details were made of all parts, such as State-rooms, Passages and all Public rooms—Plans and elevations and sections—quite an elaborate and complete set of drawings, and finally—a very comprehensive assortment of full sized drawings of everything. It was a very large problem, as everything had to be provided, all joinery—all furniture, hangings, carpets, ornaments and all fixtures—heating, ventilating, electrical and service—everything from cornices to match boxes—finished livable rooms in each case.

THE architectural problem on these vessels was almost impossible of solution because of the absolute lack of knowledge of architecture displayed by those in authority with the Shipping Board, and the absolute lack of any authority by the only man who did know architecture. As a matter of fact, a majority of these ships are being constructed without any direct architectural influence—no one with the least right to qualify in any way as an



PRIVATE SUITES

Private suites of rooms are provided, having a bed room, sitting room, a private bath room, a servants' room and trunk storage room. These suites are located on one of the upper decks in the forward deck house, and are exposed to the outside on three sides, having large rectangular port lights and private deck entrances. The furniture, hangings, carpets, etc., are of the very finest quality throughout; and, although they are carried out architecturally quite as elaborately as the style would allow, they do not display anything but refinement, comfort and home-ease and rest.



DINING SALOON

The conditions of the problem in this room were particularly entangling. The shape of the plan was rather unfortunate, due to two great hatches which come down through the ship, and due also to a great mass of pipes, vents, stanchions, heavy girders, etc. A space over the center of the room extending into the next deck overhead was "given" the architect, who was told to put a "Dome" there. Though this "given" space was small it was well located, and worked, more by accident than good management, very well into the architectural scheme. The deck on which the Dining Saloon is located is level; the deck above is cambered from the out-board to the center. This, also, is a feature which adds greatly to the interest of this room. The beams and the ceiling all pile up very slowly toward the center of the room, where a barrel vault is located, running fore and aft. One object the architect constantly struggled for was to keep the work simple so that the untrained shipyard worker could successfully produce. The barrel vault was, in fact, very simply detailed, and was made of sheet copper by workmen who took pride in this production—unusual as it was to them—and produced something rather the more interesting because of this pride and because of the rather crude, sketchy handling. The built-in mahogany sideboard, on the other hand, was rather too complicated, and the finished article has the aspect and feeling of a barber shop fixture, showing, as it does, the unskilled handling of the architectural ornaments, and that they were little understood.

THE AMERICAN ARCHITECT



SMOKING ROOM

This room contains a Bar! (?)!

The room is designed for men, and for men's particular comfort—card tables, easy chairs, deep sofas, and a fireplace. There is a semi-enclosed veranda outside the room.

The treatment is simple, although very impressive. There are many motives used in the architecture which recall Washington's house at Mount Vernon—the mantel and the window treatment. The color scheme is particularly restful and in good keeping with the architectural style.

TEA ROOM

Designed to express the garden, this room is very simple—containing as it does no ornaments and no mouldings—nothing here but simple lattice and arches. There is an elliptical-shaped bay window which projects out into a semi-enclosed veranda. This room was well handled by the interior decorator, who has employed his colors (greys and putty colors) with a mild yellow—extremely skilfully.



WRITING ROOM

The architecture in this room is very simple. The Tuscan order is used. The room contains a feeling of restfulness and repose, and is arranged with writing desks, book-cases, easy chairs, sofas and public stenographer's table.

INTERIOR VIEWS, U. S. SHIPPING BOARD S.S. "HAWKEYE STATE"

THE AMERICAN ARCHITECT

architect or artist is connected with these ships, and they are going to show it when they are completed.

The vessel herein to be introduced, was the first to be delivered—built by the Bethlehem Shipbuilding Corporation in Baltimore, Maryland, and has had at least, some influence from the architectural profession—although, nothing much more than that. The architect on this work was obliged to take a very subordinate position and the vessel if success-

much more authority than the architect—some powerful Shipping Board Expert, would step in, brush all aside and “show the world” how to do this and that. In the spirit of the child who picks the watch apart, would some gentleman suddenly discover the fascination of some planning problem—something that he had never tried before, and he would take the whole matter unto himself, and “solve” the problem “Per Order the U. S. S. B.”



HEAD OF STAIRWAY FROM MAIN SALON

ful in any way from an architectural point of view, was so because of the gracious condescension of the Powers in “standing aside.” Recognizing these ships as public property—built from funds which came from our pockets, operated and owned from the same public funds, it is only right that the public know the facts. Advertised as the “Best that America Can Produce,” it is well we all know how they were produced, that we may judge as to the truth of that boast. Is our architectural profession willing to admit that a shackled and bound architect can produce good results?

Time and again, some idle “know-it-all” with

Because the man was an expert skipper of a Galley range, he could take the authority to practise architecture.

Where much opportunity was lost in the design of these vessels to make them the *Best*, was the absolute disregard of architecture as a profession. The architect to the Shipping Board and to the Corporation building these ships, was nothing but an *artist*.

THE problems on a ship of this character are identical with problems met with in certain types of buildings. The Galley, the pantry, and the

THE AMERICAN ARCHITECT



SOCIAL HALL

The treatment of this room was extremely difficult as the construction restrictions were particularly exacting and binding. However, excellent headroom was provided over the greater part of the space (quite an unusual feature on a ship), and the architect determined to make the most of this quality. A real open fireplace is provided.

This room shows better than any other the skillful handling of their duties by A. H. Davenport, Irving Casson Company, interior decorators. Their work was a complete carrying out of the architect's original ideas and instructions, and a masterly and satisfactory working out of color schemes. The furniture is finished in black lacquer and gold, with rose mohair fabric on the upholstery. The hangings are heavy old rose plush and gold with gold cornices, and the walls and panels in their delicate cream tints produce a very charming, comfortable, refined atmosphere.

whole service problem was solved absolutely without that expert service which hundreds of our architects could have given. The solution of this problem on these ships was but an indifferent solution, in fact was quite a clumsy solution, simply because it was a new problem to those authorized to handle it. Ventilating, plumbing, sanitation, heating mechanical service problems identical in almost every way with problems architects face constantly, were stumbled against and "solved" in the same unsatisfactory manner. It was impossible to "show shipbuilders how to build ships," because shipbuilders

have constructed tugs and ferry boats for years and years; no architect on God's Green Globe could show shipbuilders how to build up a wooden cornice properly, construct a wooden column properly, miter moulded corners properly; architects cannot know anything about how to obtain a correct and workable dumb-waiter. Architects can't be expected to know about refrigeration, insulation, floorcoverings, electric wiring, proper illumination, the correct running of plumbing pipes, etc., etc. In modern buildings extremely workable and efficient schemes have been devised for running pipes, conduits, vents, heat pipes, etc., in service ducts, so that in case of trouble they may be easily reached for repairs. This same problem should have been properly met on these ships—but it was "ducked"—disregarded, put aside as "impossible!" It was impossible, with the lack of the proper expert aid—the aid that our architectural profession could have given.

On the face of things, upon a casual inspection of this ship, the architect might be credited with a "good job," but upon investigation and careful consideration, it will be found that this "architecture" is nothing but "ornament" and that architecture in its true meaning is missing. The problem has *not* been solved—it has been shamefully neglected, and the responsible parties for this neglect are public servants entrusted with public funds who have proved themselves ignorantly incompetent.

No, these ships are *not* the best that America can produce and the best will never be produced until our best talent and experience is properly recognized and employed.

Old State House, Philadelphia, Pa.

(See reproduction of original drawing by O. R. Eggers on opposite page)

The central motive and tower of the Old State House in Philadelphia provides the subject of Mr. Eggers' sketch in this issue. While the building was started in 1729, the tower was not added until about 1751.

In the belfry of this tower there was hung the bell that "proclaimed liberty throughout all the land to all the inhabitants thereof." To the great disappointment of all the people, this bell was cracked at its first trial by a stroke of its own clapper.

The Declaration of Independence while drafted, passed and signed in Independence Hall, was not, as many mistakenly infer, proclaimed from that rostrum. It was read from the platform of a small observatory to a vast concourse assembled in Independence Square, as it is now called.

452^a



OLD STATE HOUSE, PHILADELPHIA, PA.
THE AMERICAN ARCHITECT Series of Early American Architecture

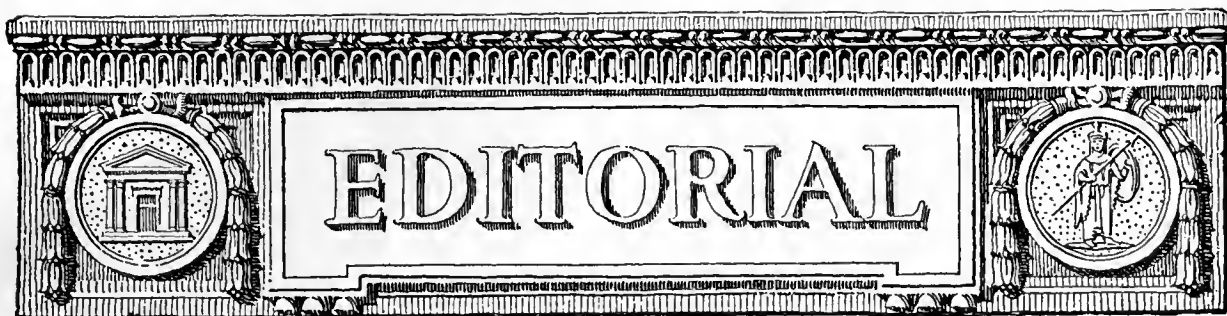

Military Honors to an Artist

When the body of Jean Paul Laurens, France's most celebrated painter, was recently borne to the grave, it was accorded the highest of military honors. A regiment of infantry, a squadron of cavalry and two batteries of artillery constituted the military escort.

Military honors to a deceased artist will, to people in this country, appear a most unusual and not easily understandable tribute. But not so to the French people, who manage these things in the right way and whose correct attitude towards art and artists has contributed largely to the high place of art in France.

When John M. Carrere met an untimely death, his body lay in state in the entrance hall of the Public Library. Recently on the occasion of the death of J. Francis Murphy, America's foremost landscape painter, the memorial services were held in the large gallery of the National Academy of Design. These tributes, however, were those of personal friends of each man who sought to do honor to the man and the artist. Never, do we recall, has a municipality or the nation tendered mortuary honors to distinguished artists. Nothing would more thoroughly impress the whole people with the great importance and influence of art than a demonstration by the Government, such as was witnessed at the funeral of Laurens. To be sure, his art was one of war and military prowess. His canvases were of dramatic incidents of French history. But the military honors accorded were not for that reason, but because it was considered due to a man who had achieved the highest possible distinction in his profession as a painter.

In this country the objects of our national acknowledgment of services are either men who have become distinguished in public office, or men who have served with high honor in our armed forces. The artist in the United States, while, perhaps fully as great in his art, while his services have been of the most valuable character in the upbuilding of art, never receives such splendid honors at his death as have just been accorded to Laurens.

National acknowledgment of the artist's services would not only be a proper tribute to art, but would have a tendency to increase the respect of the people for art and teach its great importance.

A Nationwide Digest

A nation-wide digest of facts and opinions made by the Fidelity and Deposit Company of Maryland gives what may be regarded as a reasonably accurate review of industrial and financial conditions as at present existing in this country. This digest is divided into nine subdivisions, representing the various recognized groupings of states. In every one of these localities there is no marked resumption of industrial activity. This is shown by restricted buying. A decided reduction in the cost of living is reported. Raw materials are plentiful; there are no serious reports of business failure, nor are there any strikes as affecting the building industry. The whole situation, as indicated by restricted buying and general inactivity, shows a not well founded lack of confidence.

A new administration of the national government not long enough in office to outline clearly a future policy may largely affect present conditions, but with each succeeding week the policy of the government will be more clearly shown and an early return to confidence, the forerunner of prosperity, is certain. We shall have to be patient a while longer.

As to the need for building construction, and of what class, the questionnaire, without exception as to regard to locality, has emphatically emphasized the menace of the present housing shortage. Low-priced dwellings and apartments are needed all over the country. Apparently there is an ample supply of money in the hands of the banks with which to finance building operations, but the high added charges, in addition to legal rates of interest, have had a tendency to restrict building along lines where the need is now greatest.

To sum up, it would seem that, in spite of the pessimistic utterances in some quarters, we are slowly but surely arriving at a more normal condition.

Simpler Zoning Regulations

By HERBERT S. SWAN

More than passing interest should attach to the zoning ordinance adopted by the Borough of Cliffside Park, New Jersey, September 27, 1920.

The most notable contribution of the Cliffside Park ordinance to the subject of zoning is that it for the first time in the history of such legislation in this country combines the height, use, and area zones on one map. The New York ordinance, passed in 1916, contained three separate and distinct maps—one for each of the different kinds of districts. All of the zoning ordinances passed since up to the time of the Cliffside Park ordinance followed the New York precedent.

When it is recalled that each of these different maps outlined from three to five different kinds of zones not co-terminous with one another, the complexity of the regulations becomes apparent. Thus the New York regulations, though theoretically susceptible to 75 separate and distinct combinations, are actually applied to the ground in such a manner as to form 36 kinds of districts, each with regulations differing somewhat from those of all the other districts. In the Newark ordinance the writer reduced the number of kinds of districts actually used to 25; in Yonkers, to 15, and in White Plains to 11. Each of these respectively in its turn served to simplify the application of the law. To what extent these regulations were improvements on what had previously been done may be suggested by the Minneapolis and Berkeley ordinances which permitted several hundred different kinds of combinations.

Truly progress is being made.

The Cliffside Park ordinance establishes only six different kinds of districts—one-family dwelling districts, two-family dwelling districts, multi-family dwelling districts, business district, industrial district, and heavy industrial district. Each of those different districts is supplied with its own independent set of height and bulk regulations. Instead of having to examine three different maps to ascertain how the zoning regulations affect his property, the resident of Cliffside Park has to examine but one. The advantage of having but one map is obvious—it reduces zoning to its A, B, C.

For communities having different types of buildings pretty well segregated in different localities, and where the conditions are not too complex, it is thought that the Cliffside Park ordinance will mark a new departure in zoning. It is, however, not claimed that the height, use and area regulations can always be combined in one set of districts as was done in Cliffside Park. Where the conditions are very heterogeneous and considerable elasticity is desired, it may still prove desirable, as hitherto, to

utilize three maps and three sets of districts in order properly to adapt the regulations to the existing or prospective building development. It all depends whether simplicity or elasticity is the keynote to any particular case, whether one or more maps need be used.

Congestion Defended by Landscape Architect

"Congestion," says Wellford Leavitt, landscape architect, "is one of the great reasons why New York has prospered. It is one of her attractions. It should be preserved, but careful study should be given and relief in the form of regulation and provision for the traffic and reducing the number of human beings at those points where almost all human beings apparently wish to be."

For the relief of city traffic congestion Mr. Leavitt has suggested seven new thoroughfares, five of which would be elevated vehicular express ways through the centre of blocks, one, an express way over an existing street and the other an entirely new street.

Mr. Leavitt places the projected new street, in the great commercial developing section on the west side between Seventh and Eighth Avenues. This street, he suggests, might be cut through north and south between Seventh and Eighth Avenues, from Twelfth to Thirty-first Street, where it would be broken by the Pennsylvania Station, and then resumed from Thirty-fourth to Forty-sixth Street. His express way would be placed over First Avenue, extending from Twenty-fourth to 125th Streets.

The five interior express ways which form the more comprehensive part of his program and would not entail the expense of acquiring real estate for the cutting through of a new thoroughfare in a well-built-up portion of the city are suggested in the following routes:

Between and parallel to First and Second Avenues from Twenty-fourth to 127th Street.

Between and parallel to Second and Third Avenues from Tenth to 128th Street.

Between and parallel to Fifth and Sixth Avenues from Eighth Street to Central Park South.

Between and parallel to Ninth and Tenth Avenues from Fourteenth to 110th Street, those avenues being Columbus and Amsterdam, respectively, above Fifty-ninth Street.

Between and parallel to Tenth and Eleventh Avenues from Seventeenth to Seventy-third Street.

"Connection between the ground and these elevated express ways should be made every ten blocks or so, by ramps leading to the less travelled ways, such as Fifteenth, Twenty-fourth, Thirty-fifth Street and others," Mr. Leavitt explains. "Wheeled

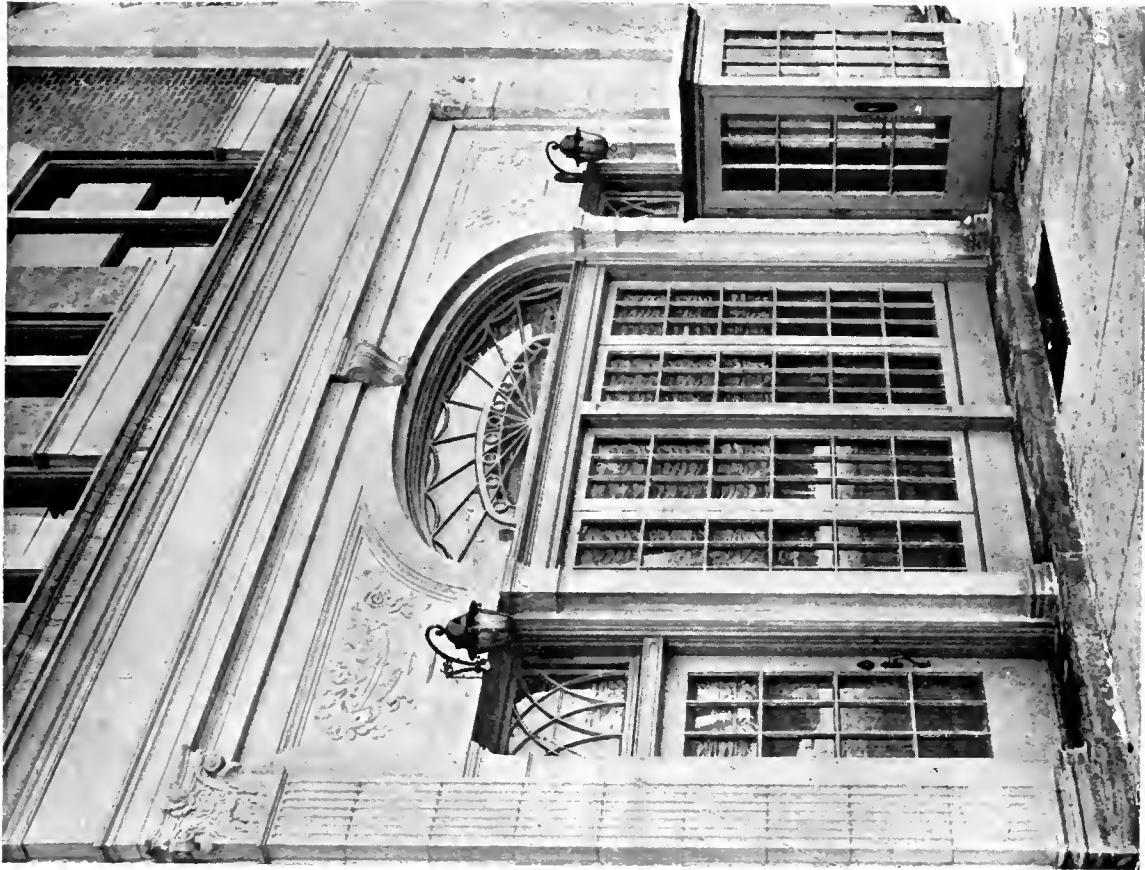

MENASHA CAFE, MENASHA, WIS.
CHILDS & SMITH, ARCHITECTS



THE AMERICAN ARCHITECT

vehicles from the express ways should not be brought into already overcrowded ways, such as Fourteenth, Twenty-third and Thirty-fourth Streets. Pedestrian approaches might be made more often, by stairways or ramps. Arrangements could be made for stopping automobiles on the sides of the express ways, as here doubtless will be popular locations for stores because of the passing traffic. In the centre there might be through roadways, where speed could be attained with no interruption from cross traffic.

"It has been suggested that these express ways be constructed as overhead tunnels, using the roofs for access to adjacent buildings. This would mean closed vehicular passageways above ground. Also, it has been suggested that ramps leading to the express ways from the street level be placed in the middle of blocks, instead of at street crossings, thereby reducing the amount of street frontage to be destroyed. These details require much consideration, with careful thought as to the problems of light, proper ventilation and the disposition of gases from automobiles.

"The bridges which already have been built between Manhattan and the Bronx, Queens and

Brooklyn have necessitated radical changes in the street layouts near the bridge-heads. It will be necessary to make still further changes in order to handle the traffic from these bridge-heads into the adjacent territory. The congestion at these points is constantly increasing, and the bridges are ever delivering to the city more and more people hurrying to the points of greatest attraction on Manhattan. Streets should be planned now connecting the present bridges with the proposed bridges and tunnels over and under the Hudson River to New Jersey.

"When these proposed bridges and tunnels are completed there will be considerable through traffic from New Jersey and the south to Long Island, the north and the east, and they will form a link in a very direct route between the south, the north and the east. All of this traffic will come through the already congested Borough of Manhattan; therefore, it is quite essential that ways be provided to carry the through traffic around and not through the more crowded districts. If this is not done we will have an aggravation which will more than counteract any good realized from other methods of relief."



HOUSE OF MOWRY SMITH, MENASHA, WIS.
CHILDS & SMITH, ARCHITECTS

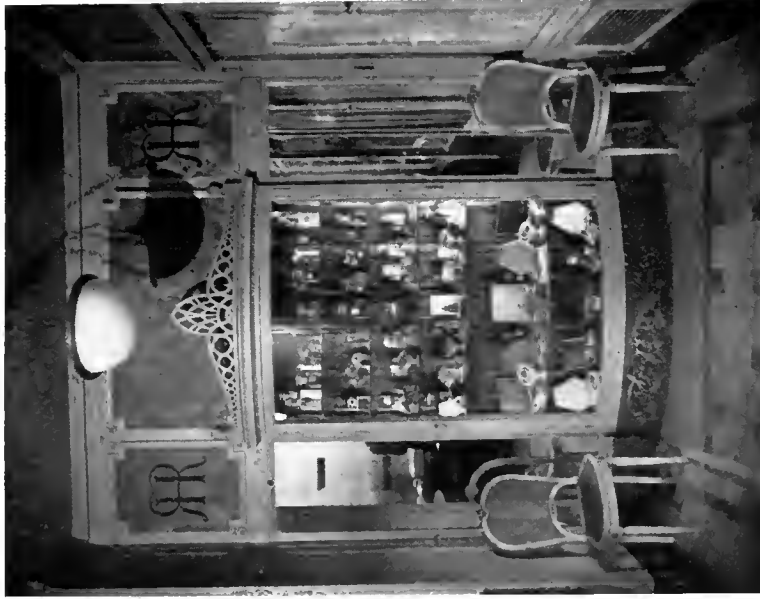

DISPLAY CASE OF THE RICHARD HUDNUT STORE, AT 400 FIFTH AVENUE, NEW YORK
DESIGNED BY G. A. AND H. BOEHM, ARCHITECTS
The showcase is located near the front entrance of the store; it is executed in gray enameled woodwork

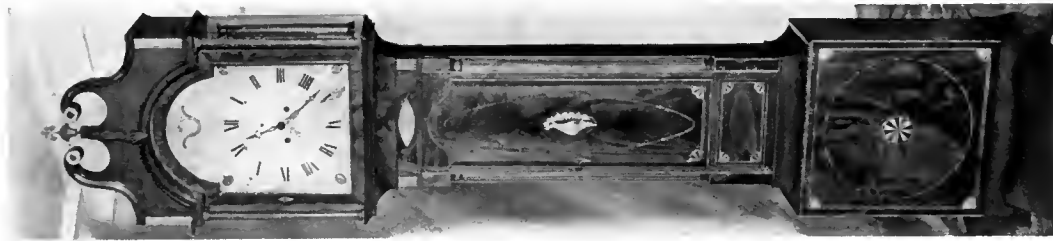

AMERICAN HEPPLE-
WHITE MAHOGANY
HALL CLOCK



INTERIOR OF SHOWROOM OF RICHARD HUDNUT IN THE BUSH TERMINAL BUILDING, NEW YORK

G. A. AND H. BOEHM, ARCHITECTS

The showcases are constructed of wood and bronze, and the color scheme is Pompeian. The ceiling hangings are of blue silk. The spirit of the decorative scheme is excellent.



HOUSE OF E. I. WOODWORTH, PASSAIC, N. J.
JOHN F. JACKSON, ARCHITECT



COSMOPOLITAN STATE BANK, CHICAGO, ILL.
RICHARD E. SCHMIDT, GARDEN & MARTIN, ARCHITECTS

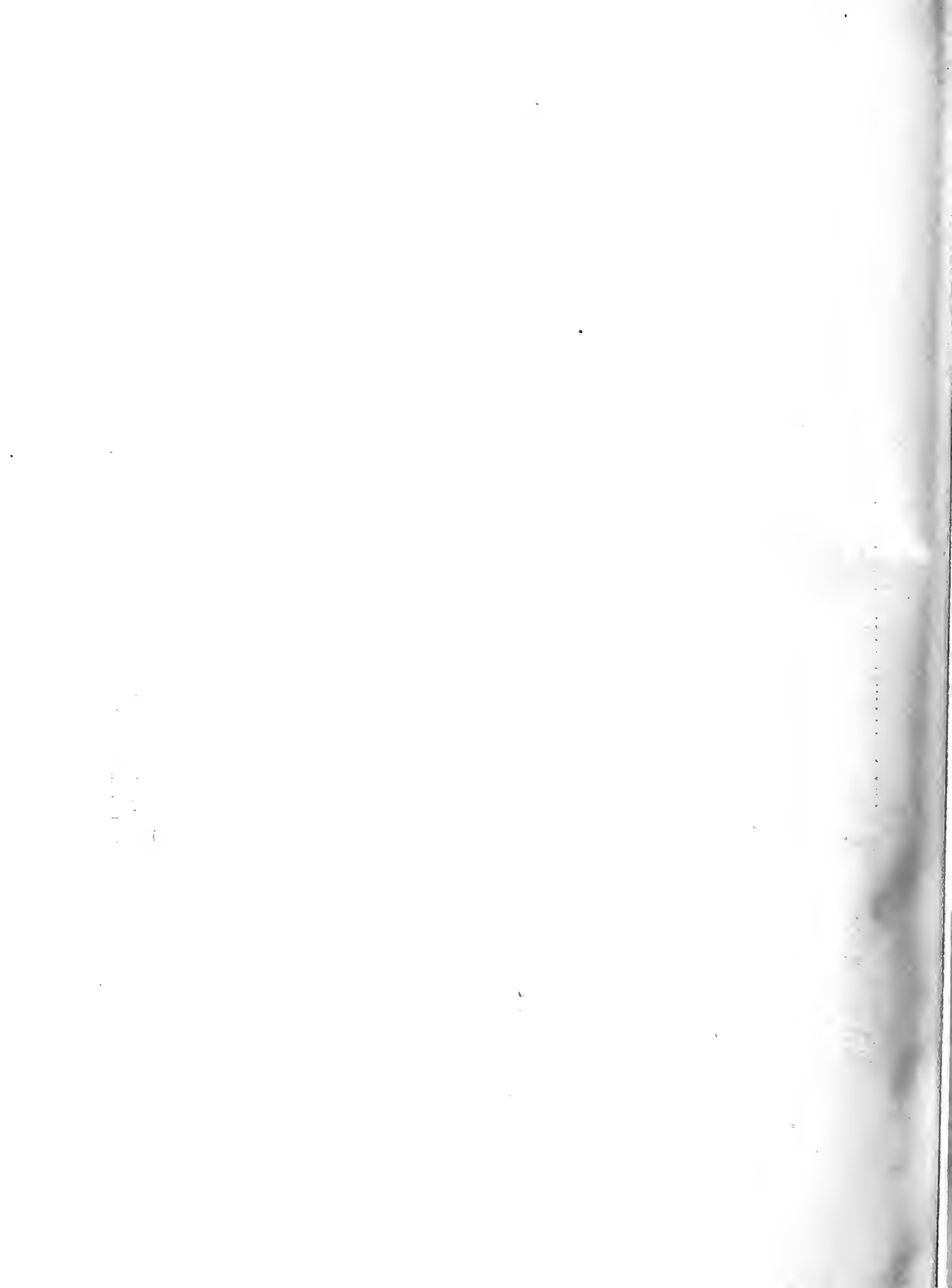

45-8 2

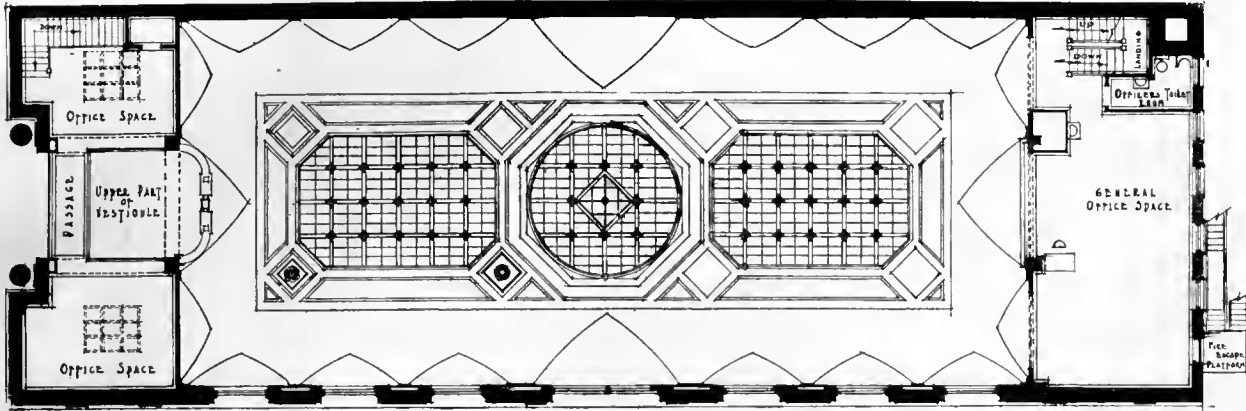

SECOND FLOOR PLAN

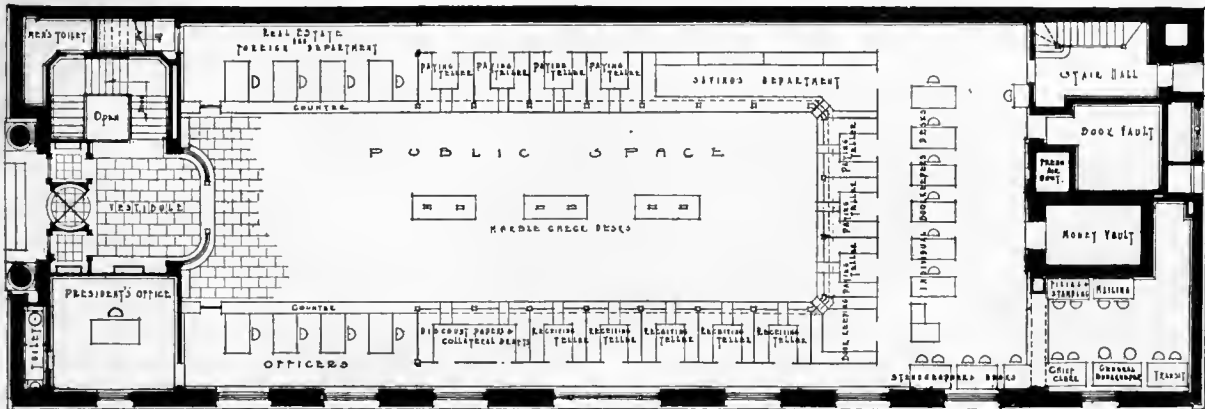

BANKING ROOM FLOOR PLAN

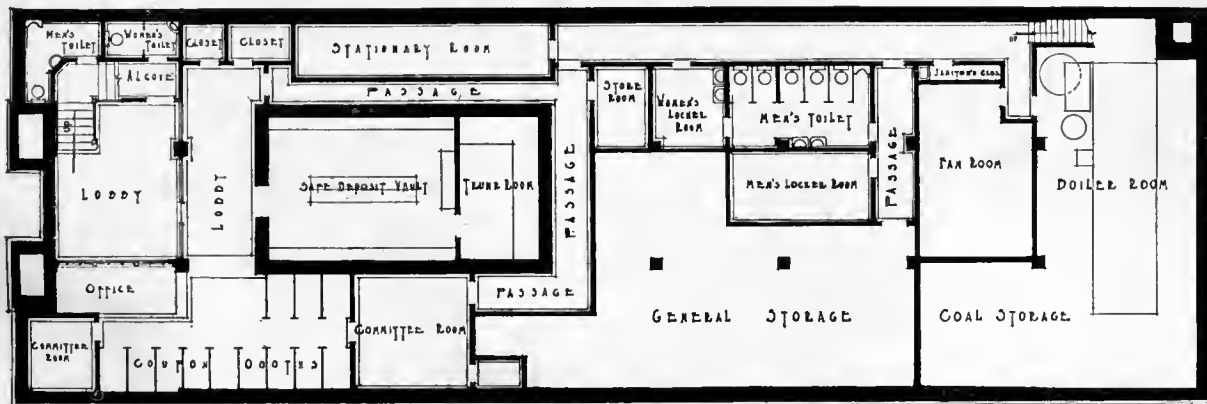

BASEMENT PLAN

COSMOPOLITAN STATE BANK, CHICAGO, ILL.
RICHARD E. SCHMIDT, GARDEN & MARTIN, ARCHITECTS



DETAIL OF MAIN ENTRANCE
COSMOPOLITAN STATE BANK, CHICAGO, ILL.
RICHARD E. SCHMIDT, GARDEN & MARTIN, ARCHITECTS

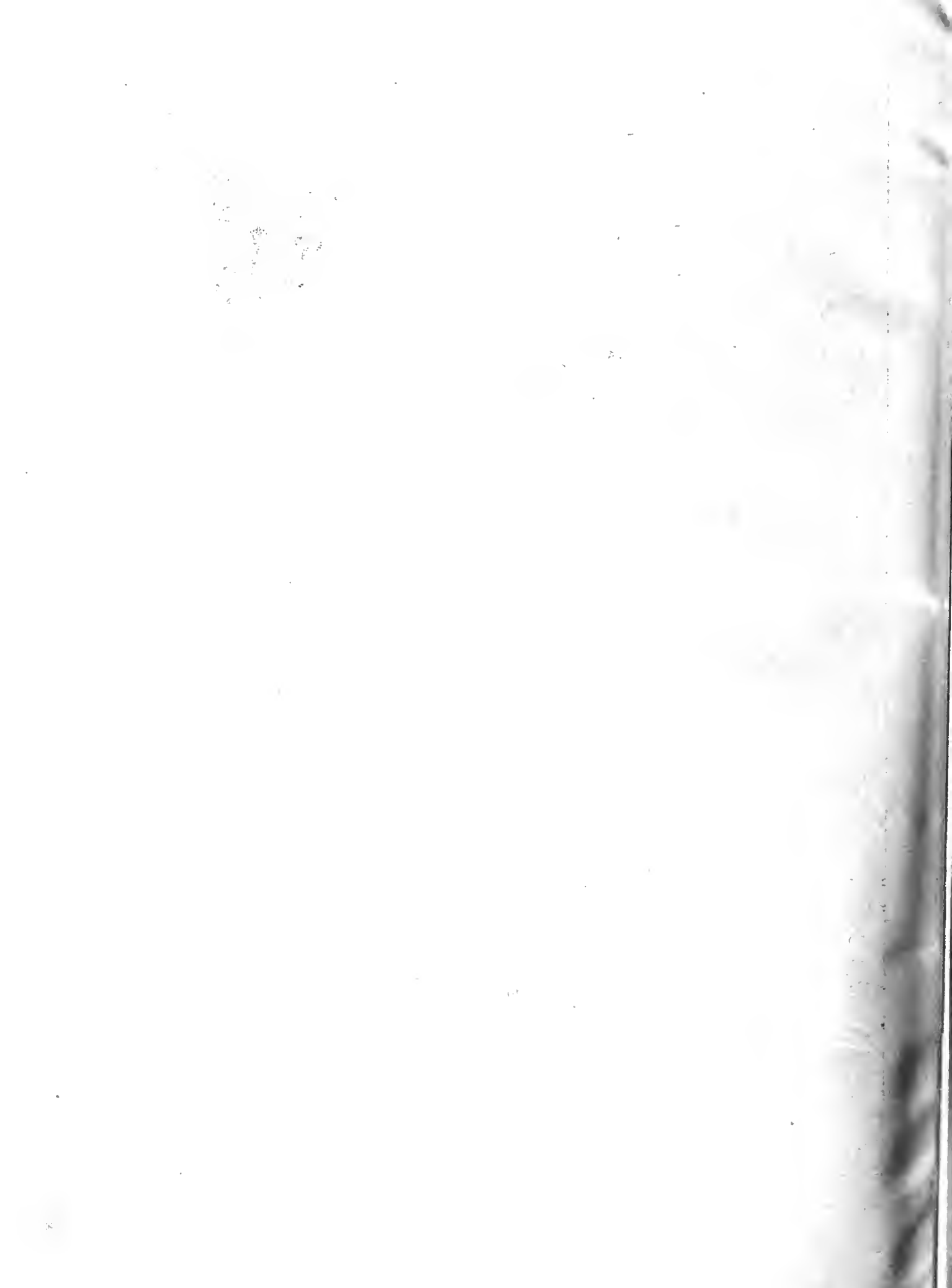



COSMOPOLITAN STATE BANK, CHICAGO, ILL.
RICHARD E. SCHMIDT, GARDEN & MARTIN, ARCHITECTS

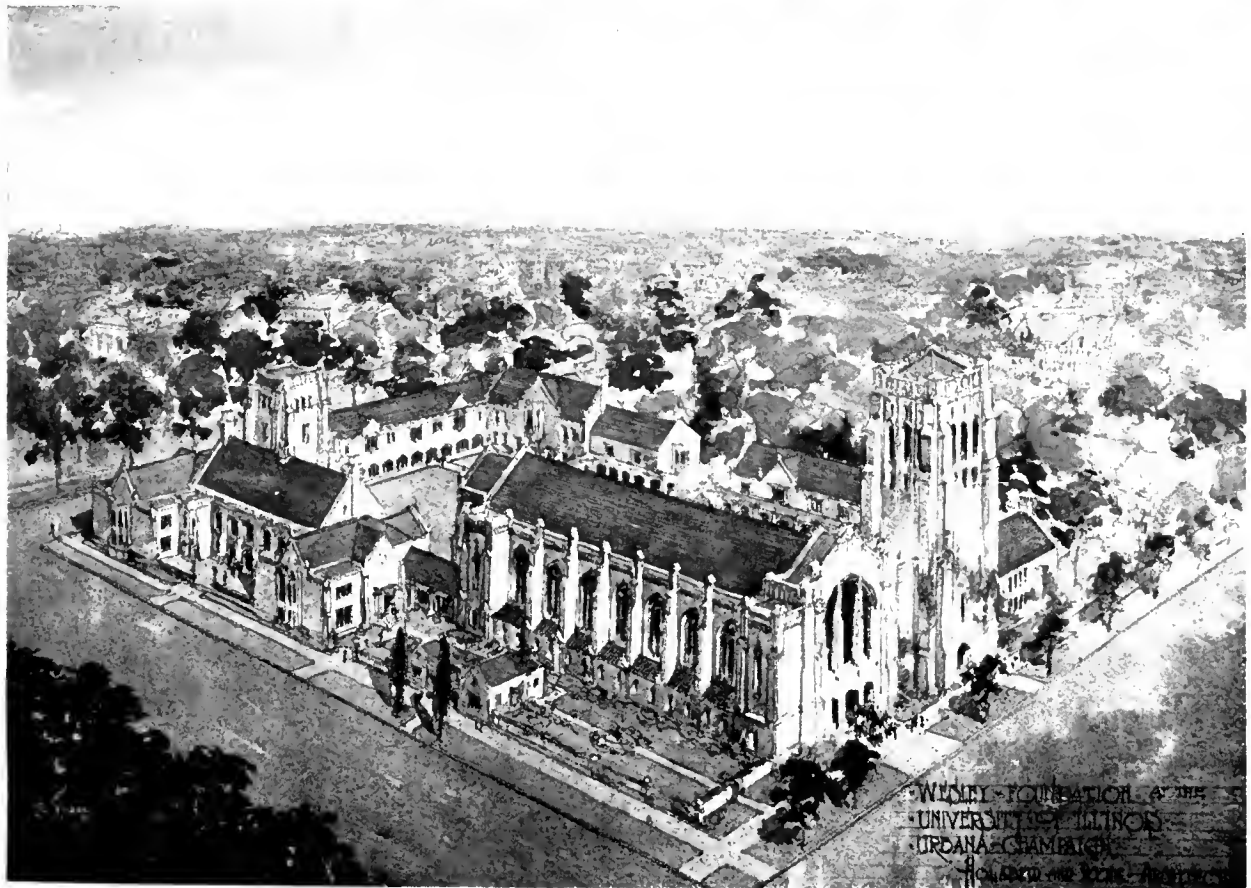

WESLEY FOUNDATION, UNIVERSITY OF ILLINOIS, URBANA, ILLINOIS
HOLABIRD & ROCHE, ARCHITECTS

458⁶

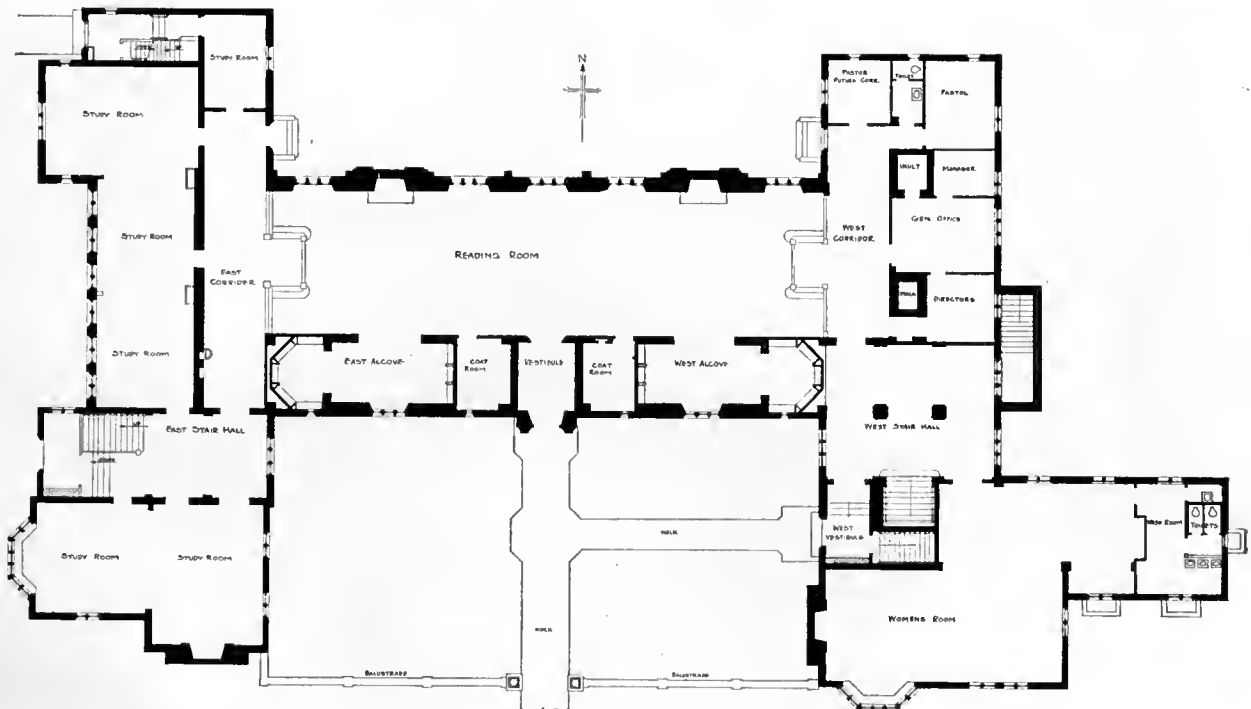

FIRST FLOOR PLAN

SOCIAL CENTER BUILDING
 WESLEY FOUNDATION, UNIVERSITY OF ILLINOIS, URBANA, ILLINOIS
 HOLABIRD & ROCHE, ARCHITECTS

458

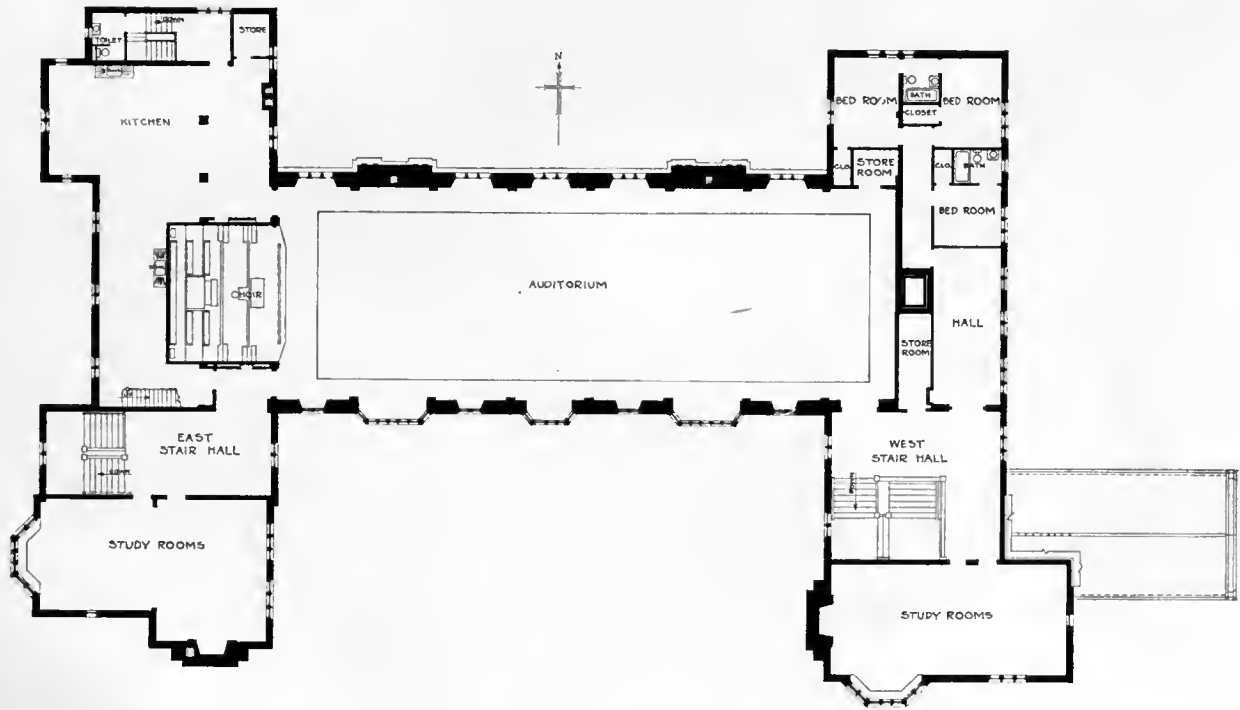

SECOND FLOOR PLAN

SOCIAL CENTER BUILDING
 WESLEY FOUNDATION, UNIVERSITY OF ILLINOIS, URBANA, ILLINOIS
 HOLABIRD & ROCHE, ARCHITECTS



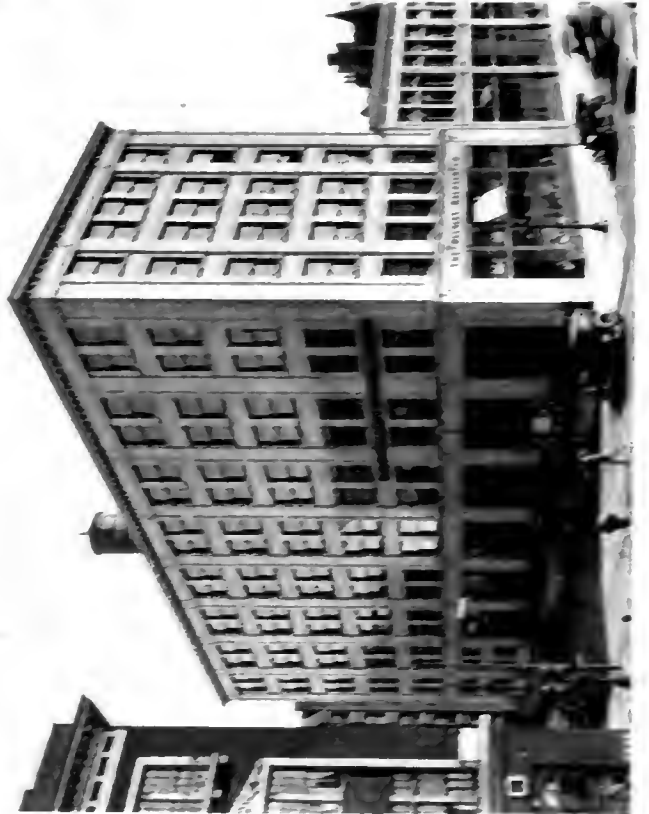

ABOVE, BUILDING FOR MASSWELL SALES CO.
 ABOVE, AT LEFT, BUILDING FOR R. F. DECKER CO.
 BELOW, AT LEFT, BECKLEY RAISON CO. BUILDING.
 THREE CHICAGO BUILDINGS BY
 HOLABIRD & ROCHER, ARCHITECTS.

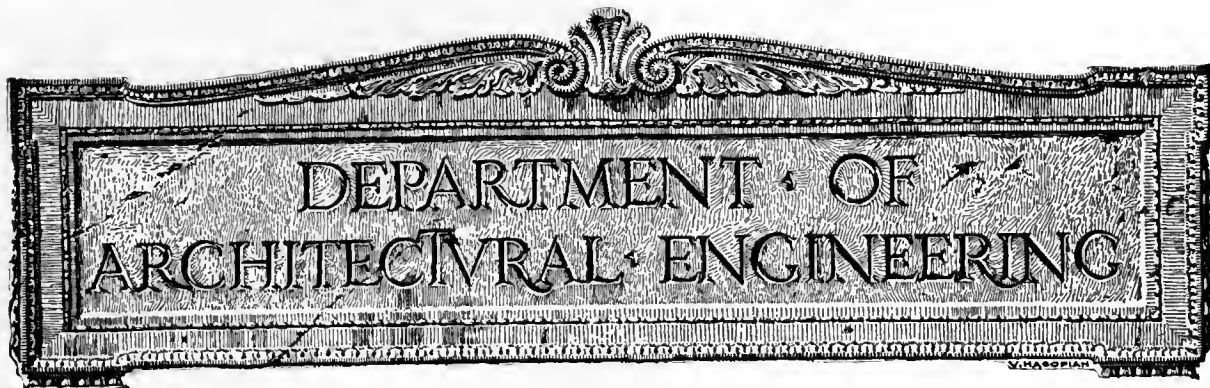

Ventilation of the Home Office Building of the Travelers Insurance Company, Hartford, Conn. *

IN an office building comparable in size with the home office of The Travelers Insurance Company (in which there are some four thousand employees) it is a serious problem to provide without producing drafts the great quantity of fresh air that is required by the working force.

To solve this problem, there has been installed an elaborate and efficient artificial ventilating system, by means of which the right quantity of air is delivered, at the proper temperature, to every room in the building. The vitiated air is removed, and fresh, pure air is supplied and diffused so unobtrusively that no drafts are observed at any point.

The system is composed of two distinct and separate parts, (1) the blower section, which includes the distributing apparatus, and (2) the exhaust section which consists of the apparatus by means of which the used or vitiated air is removed from the building. In each of these sections, the air is propelled through metal ducts and chambers, by means of a draft from powerful fans operated by individual electric motors. The main ventilating ducts run up and down through the middle portion of the building, and branches from them follow the halls and passageways. From these branches, short ducts lead into and out of the various rooms. The building is divided, for convenience, into six sections, and a separate unit of ventilating apparatus is employed in ventilating each section.

The north side of the ten-story part of the building comprises one of these sections, and the air for this portion of the building is obtained from out-of-

doors through a large sheet-metal duct extending from the roof to the basement. A fan, 120 inches in diameter and operated by a thirty-five horsepower motor, draws in the air through this duct and forces it through the distributing system to the various rooms. The south side of the building is supplied with air by two fans and motors that draw the air in through a single duct, similar to that on the north side of the old building, and extending from the roof to the basement. One set of apparatus distributes air to the first five floors of this section, and the other unit takes care of the air supply for the five upper floors. In the tower section, the first ten floors are supplied with air obtained through a duct extending from the eighth floor to the basement, and the upper floors of the tower—that is, floors ten to twenty-six—are supplied by apparatus located on the twenty-sixth floor.

The basement and sub-basement are ventilated by air obtained from the duct used for supplying the ventilating apparatus on the south side of the ten-story building. All fans are driven by direct-current, slow-speed motors, and the apparatus is specially set to minimize vibration and the transmission of sound.

In each unit, the air that is brought in from out-of-doors is drawn into a screen chamber, where it passes through screens or air filters, consisting of fine muslin fastened over wooden frames. These frames are set between the screen chamber and the fan chamber, so that the draft produced by the fan will draw the air through the screens, and the dust and other suspended solid matter are filtered out

*Reprinted from The Travelers Standard, September, 1920.



BUILDING OF THE TRAVELERS INSURANCE CO., HARTFORD, CONN.
DONN BARBER, ARCHITECT

and retained by the muslin filters. The screens in each chamber are removed and cleaned every week.

AFTER passing through the screens, the air enters the fan chamber—that is, the compartment in which the propeller or fan operates. It is then forced through the distributing ducts to the



A SECTION OF ONE OF THE AIR FILTERS

This photograph was taken in the screen chamber at the bottom of the large air duct in the south side of the building

rooms about the building. In cold weather the filtered air is passed over steam coils that are situated in the fan chambers, and heated to the proper temperature before going out through the distributing ducts.

Each outlet that leads from the supply ducts to the rooms in the building is provided with a regulating apparatus to control the volume of the incoming air according to the needs of the occupants of the room that it serves. In the larger rooms, deflectors are provided over the outlet openings, so that the air can be delivered at a high velocity and in great volume, and still be dispersed so as not to produce drafts. The velocity of the air is also regulated by apparatus attached to the fan motors. The temperature of the air is regulated by thermostats, one of which is situated in each room. The thermostats are set to the desired temperature, and this temperature is maintained automatically by a master thermostat in the basement.

In most places, the exhaust ducts used in carrying the vitiated air out of the building run parallel to those of the blower or distributing section of the ventilating system. Two openings through which air enters the exhaust ducts are provided in each room. The two openings in each room are always on the same duct, one being located near the floor

and the other near the ceiling. In cold weather the upper opening is closed, and cold air is removed from the room through the opening near the floor. In warm weather, on the other hand, when it is desired to remove the warm air, the lower opening is closed, and the air is taken out through the opening near the ceiling.

The air that is removed from the rooms is carried along the exhaust ducts by a suction created by electrically-operated exhaust fans. In each section of the building a double set of fans is used, one of which draws the vitiated air from the toilet rooms, while the other is operated for the office rooms only. Four of these fans are located in the pent-house over the ten-story part of the building, and in the tower section two fans and motors are situated on the eighth floor and two more are located on the twenty-sixth floor. The exhaust fans and motors serving the basement and sub-basement are situated in the basement and discharge into a flue in the north side of the building. This flue was once used to carry off the gases from the boilers in the basement, but when the new smoke-flue in the tower was completed, the old one was no longer needed for the boilers, and it was therefore put to good use in connection with the ventilating system, as indicated. The fans and motors used in the exhaust or removal system are similar to those used in the supply system.

IT will be easier to understand the operation of the apparatus we have described if we consider the course of a single particle of air, follow it as it goes through one of the units of the ventilating system—say, that on the north side of the ten-story part of the building. It will be caught from the outside atmosphere in the suction at the opening of the big

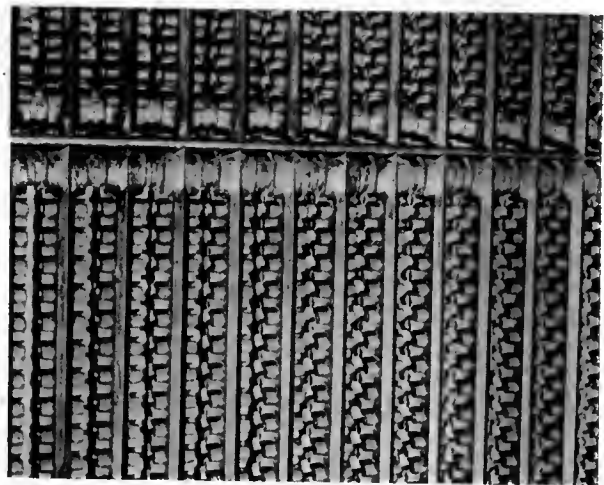

A PART OF ONE OF THE STEAM-COIL STACKS

In cold weather the incoming air is drawn through these stacks and heated to the proper temperature

THE AMERICAN ARCHITECT

supply duct on the roof, and be drawn down through this duct to the basement. Here it will pass through the muslin screens and be cleaned, after which it will go through the fan and be pushed up through the distributing duct and out through a branch duct into one of the workrooms or offices. Some of the air that accompanies the particle into the workroom will be breathed by the employees, and when it is exhaled again it will have its oxygen content greatly reduced and its carbon dioxide content correspondingly increased. It will also be much warmer than before, and will be heavily laden with water vapor.

to twice that required by the Board of Health and by the standard authorities on ventilation, and the ventilating system in these rooms is operated continuously during office hours. Excessive exhaust is provided in connection with the toilet rooms.

The exhaust system in the workrooms is also in continuous operation during working hours, but in warm weather when the employees desire to work with the windows open, the supply system is operated only as it may be needed. The entire ventilating system is started in operation, on the morning of each working day, about three hours before



A PART OF THE BLOWER SYSTEM

These motors and fans supply air to the south side of the building. A thermostat is shown on the duct in the upper part of the picture

In this condition it would be unfit for breathing, and if allowed to remain in the room it would mix with the rest of the air there and vitiate it. The particular particle of air we are following may be breathed, or it may only be mixed with vitiated air; but in either case it will presently be caught in the suction at one of the exhaust-duct openings. Here it will be drawn into the exhaust duct and carried upward by the suction from the exhaust fan on the roof.

Proper ventilation in the toilet rooms about the building is maintained by ducts entirely independent of those operated for the workrooms. The toilet rooms are furnished with an amount of air equal

the regular office hours. During the noon hour the fans are operated at full capacity, in order to change the air thoroughly in every room.

The blower system in The Travelers home office building is capable of furnishing eleven million cubic feet of air per hour. The combined length of the ducts through which the air is passed is 116,160 feet (or twenty-two miles), and 464,640 pounds (or 232 tons) of metal were used in constructing them. Six centrifugal blower fans, one centrifugal exhauster, and seven propeller or disk-type fans are used. To operate all the fans at full speed requires about 150 horsepower.

Overhead and Underground Streets For New York

As far back as the early 60's a steam subway with underground streets was proposed for New York City, but never built.

Today, with congestion becoming daily a more perplexing and important factor, Deputy Police Commissioner Harriss comes forward with a proposal for building a viaduct on Sixth Avenue from Fortieth to Fifty-ninth Street. His plan is to have roadways constructed on either side and on the same level with the Sixth Avenue elevated line. There is a space of forty feet on either side of the tracks. This would relieve the congestion not only on Sixth Avenue, but would divert much traffic from Fifth Avenue, thereby still further relieving conditions on that thoroughfare. The chief difficulty in accomplishing this is to be found, according to Mr. Harriss, in the objection of the property owners on Sixth Avenue who think their property values would be greatly reduced by such a structure. Mr. Harriss maintains that two street levels of the property thus affected would be enhanced in value to the extent of \$20,000,000.

The congestion on Fifth Avenue, between Fourteenth and Fifty-seventh Streets, would be relieved by a plan proposed by D. L. Turner, Chief Engineer of the Transit Construction Commission. It is proposed to increase the width of the roadway by decreasing the width of each sidewalk 50 per cent., then to build underground sidewalks of the same width and to use the space between for the operation of moving platforms.

This is one of the plans. The other provides for an elevated roadway of ornamental design and a decrease in width of the sidewalks, thus adding width to the roadway.

The underground plan suggested for Fifth Avenue would cost, it is said, \$8,000,000 a mile and the overhead plan about \$1,500,000 a mile. The proposed plan would increase the vehicular roadway on Fifth Avenue 27 per cent., and the sidewalk capacity 51 per cent. The overhead plan would increase the vehicular roadway 38 per cent. and the sidewalk 42 per cent.

"The north and south streets of New York are hopelessly inadequate," Mr. Turner pointed out. "There are only about 100 miles of up and downtown streets to serve 325 miles of crosstown streets. There are only eleven up and downtown thoroughfares to serve approximately 150 crosstown streets

In other words, there are about fourteen crosstown streets to one up and downtown street.

"The remedy is the construction of entirely new streets. This means either underground or overhead streets over the lines of existing streets."

Inconsistencies of Some Building Codes

Three paragraphs from one section of a proposed building code of one of the large cities of the United States illustrate the lack of continuity and the unsystematic and illogical compilation which characterize many building ordinances.

All codes should be erected upon a foundation of basic regulations and restrictions, with local superstructure following consistent and clearly defined lines. If details are started as to public health regulations, other clauses defining these regulations should be under this group; or if the code begins with restrictions on dwelling construction, this subject should be covered in one section or adjoining sections, and pertinent paragraphs should not be dropped here and there throughout the entire code.

The paragraphs referred to as in the large city code are numbered 23, 24 and 25 and read as follows:

- 23 Seats of all chairs in all theatres and all places of amusement must be provided with springs so that they will be in an upright position when not occupied.
- 24 No horse, cow, sheep, goat, or other domestic animal, excepting a cat or dog, should be lodged or housed in any building used for an habitation, except sleeping apartments may be provided in stables for the employees thereof.
- 25 It shall be the duty of the Inspector of buildings to supervise the emptying and cleaning of the sinks attached to the public schools of the city.

Although these three paragraphs do not pertain to the use of lumber in construction or to legislation affecting lumber, they are typical of the confused statements or groupings which are found in many building code sections governing the use of wood.

It will be noted in these three paragraphs that three specific and yet distinct portions of a building code are intermingled. The first relates to theater construction; the second to public health and property rights, and the third, to the duties of the building inspector.

Where the entire building code is so confused—and these paragraphs are typical—interpretation and application are difficult. Review and revision of an illogical code is no small accomplishment.

Raising and Shoring a Fireproof School House

WHEN it became necessary to increase the capacity of St. Theodore's Parochial School, Chicago, it was accomplished by adding a third story. The building is a fireproof structure, the floors and roof being supported by steel girders and columns, the floors made of concrete joists and hollow tile. It was found that the foundations were of ample size to carry the added load and that the structural steel columns in the basement only would require additional area of cross-section. These columns were reinforced by the addition of steel angles so attached and combined with the original column that they received their proper proportions of the load.

It was decided to raise the existing ceiling and roof to the height necessary to provide for the added third story. In order to do this the columns were cut at the second floor level, stripped of their fireproof covering and raised with the roof and ceiling to the new level. The partitions, with the door frames and trim, blackboards and other parts were left standing intact.

New second-story columns were installed and connected with the columns above and below. Steel girders were placed for the new third floor, which

was put in position above the tops of the standing partitions. New partitions were erected in the added third story. The old roof was undamaged by the raising to the higher elevation. The old ceiling was made of metal lath and plaster, suspended from the roof framing. Scarcely any damage was done to the ceiling by raising it to the new position. It can be



FIG. 2



FIG. 1

seen by inspecting the illustrations that the ventilating apparatus, ducts and other equipment in the attic space were undisturbed.

The raising power was applied to the steel columns near the ceiling. Large vertical angles were attached to the column flanges, under which were placed two channels, which were also bolted to the column flanges. Under these channels were placed two small, short I-beams and two long, large I-beams resting on heavy wooden cap timbers.

Beneath these wood caps the jack screws were placed and the wood cribbing built up as the structure was raised. Care was taken to anchor this cribbing by the use of wood struts and wire cables, thus preventing any lateral movement due to wind or other causes.

The work was done quickly, the chapel

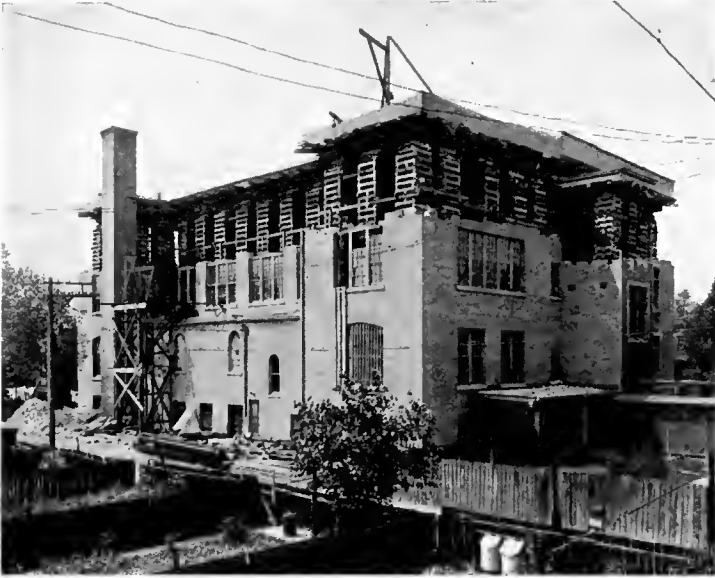

RAISING AND SHORING A FIREPROOF
SCHOOL HOUSE

FRONT AND REAR VIEWS OF
ST. THEODORE'S PAROCHIAL
SCHOOL, CHICAGO, DURING
THE OPERATIONS



VIEW SHOWING ROOF RAISED AND SUPPORTED

in the first story was used throughout the time of remodeling, and the cost was not excessive. The improvement was made under the supervision of Henry J. Schlacks, architect; the Flat Slab Engineering Company, structural engineers, and the L. P. Friedstedt Company, engineers and contractors, for raising and shoring.

The American Engineering Standards Committee

ALTHOUGH the American Engineering Standards Committee has been actively at work for only slightly more than one year, and much of the time and effort of the Committee has necessarily been spent in laying a basis for work the fruition of which will require at least two or three years, yet considerable progress has already been made in the unification of the more important standards and in overcoming the confusion that was being produced by the numerous organizations (more than 100) that hitherto published engineering standards without systematic co-operation among themselves.

Prior to December 31, 1920, there had been approved by the Committee "Tentative American Standard Specifications and Tests for Portland Cement," "Tentative American Standard Specifications for Fire Tests of Materials and Construction," and "American Standard Pipe Threads." Moreover there had been submitted for approval by the Committee the "National Electrical Code" as an American Standard, and "Standard Test for Toughness of Rock," "Standard Method of Distillation of Bituminous Materials for Road Treatment," and "Standard Method of Sampling Coal," as Tentative American Standards, with the "Safety Code for Head and Eye Protection" submitted for approval as "Recommended American Practice."

The Committee itself is composed of 47 members representing 17 bodies or groups of bodies, including six national engineering societies, five Governmental departments and 13 national industrial associations. Its function is merely to see that each body or group concerned in a standard shall have opportunity to participate in its formulation which is in the hands of a working committee, technically called a "sectional committee." Each sectional committee is organized by, and under the leadership of,

one or more of the principal bodies interested, such bodies being known as "sponsors." Sponsorships have been arranged for the following projects which were under way by the beginning of this year:

Electrical Projects—"Rating of Electrical Machinery" and "Term-Markings for Electrical Apparatus."

Mechanical Projects—"Ball Bearings," "Plain Limit Gages," "Gears," "Machine Tools," "Nut and Bolt Heads," "Pipe Flanges and Fittings," "Screw Threads," "Shafting."

General Projects—"Passenger and Freight Elevators," "Color Scheme for Pipe Lines," "Steel Shapes," "Zinc Ores and Zinc."

Safety Codes—"Aviation Safety Code," "Construction Work," "Electrical Fire Code," "Electrical Safety Code," "Floor Openings, Railings, Toe Boards," "Foundries," "Gas Safety Code," "Grinding Wheels," "Head and Eye Protection," "Ladder Code," "Lighting Code," "Lightning Protection," "Logging Operations and Sawmill Machinery," "Machine Tools," "Mechanical Transmission of Power," "Paper and Pulp Mills," "Electrical Power Control," "Power Presses," "Mechanical Refrigeration," "Industrial Sanitation," "Stairways, Fire Escapes and Other Exits," "Textiles," "Ventilation," and "Woodworking Machinery."

As will be seen from the above lists, an important part of the Committee's work relates to safety codes. On December 8, 1920, at a conference at which more than 100 organizations were represented it was unanimously voted that a comprehensive program of safety codes should be undertaken, to be carried out under the auspices of the American Engineering Standards Committee to insure proper coordination and elimination of overlap, etc. Active work is now in progress on 24 such codes with hearty co-operation among the state commission, associations of insurance companies, national engineering societies, manufacturers' and industrial associations, labor and civic organizations, and technical bureaus of the Federal Government. As is true of all work under the auspices of the American Engineering Standards Committee, such of the bodies as are interested in the particular code in question are represented in the committees responsible for the formulation of each code.

Copies of the Report may be obtained by addressing a request to the American Engineering Standards Committee, 29 West 39th Street, New York.

Current News

Happenings and Comments in the Field of Architecture and the Allied Arts

William Willett Dead

William Willett, widely known to architects as a designer and exponent of the highest development of the art of stained glass construction, died on March 23 at his home in Philadelphia. He was fifty-six years old. Mr. Willett's work has been along the most progressive lines, and he brought to it a finely developed appreciation of the possibilities of stained and painted glass as relating to architecture. Notable examples of windows designed and executed under his direction are the chancel windows in the military chapel at West Point, N. Y., and in the chapel at Princeton Theological Seminary.

Notice of Annual Meeting

The eighth annual meeting of the Association of Collegiate Schools of Architecture will be held in Washington, D. C., on May 9 and 10 preceding the annual convention of the American Institute of Architects, which opens on the 11th. The exact place of the meetings will be announced later, but the time for sessions probably will be closely as follows:

Monday, May 9, at 3:00 and 8:00 P. M.

Tuesday, May 10, at 10:00 A. M. and at 2:00 and 8:00 P. M.

Wednesday, May 11, probably adjourned meetings.

All educational institutions offering courses for professional training in Architecture are cordially invited to send representatives to these meetings, which are open to all who are interested in our work and problems. Visitors have the privilege of the floor in discussions and may vote on questions indicating the "sense of the meeting."

The Birren Prize

Intended to Bring About a Co-operative Spirit Between the Architect and the Artist Painter

The Art Institute of Chicago comes forward with an offer of the Birren prize for "the best design in color showing an interior of two walls, with at least one window, one door, a mantel, and appropriate space for the distribution of three or four standard size paintings." The circular runs in part as follows:

The object of this "Birren prize" is to bring about a co-operative spirit between architect and artist

painter, and stimulate the architect's desire to make a more artistic appropriate use of wall spaces than has been the tendency in the past. It is Mr. Birren's contention that less expense in mouldings and plastic ornamentation and more thought given to the painter's art in the proper handling of flat surfaces would be restful, more comfortable and pleasing to the eye.

It is also contended that framing and hanging of pictures as at present practised is inconsistent with present interior designs and taste, and that it be made the architect's business to suggest fitting and harmonious moulding for frames and tasteful installation of the canvas on the wall, thereby working in sympathy with his client, the possible owner of cherished and appropriate pictures—working with the owner or tenant of the building and creating a co-operative harmony, rather than as so often practised by that method of washing one's hands of a troublesome unsolved problem and advising the exclusion of painting art, will unquestionably eventually tend toward a disorganized condition of all the arts related to building.

Nobody Wants the Leviathan

What to do with the Leviathan, the "ex-boche floating white elephant," remains an unsolved problem. Admiral Benson thinks the vessel might be reconditioned into a second and third class passenger carrier. Various solutions have been proposed, and in the meantime the Leviathan has remained at her dock in Hoboken since September, 1919, accumulating rats, mud and rust.

When bids were made for her reconditioning the lowest was the one made by the Boston Navy Yard, \$8,939,000. Some of the experts say that \$12,000,000 would be necessary for restoring the 54,000-ton liner to her former state. The original construction cost was about 12,000,000 marks, which amounted to about \$3,000,000 at the exchange rate then prevailing.

The Leviathan and the Emperor, both of the Hamburg-American Line, were very popular in the passenger trade, and they afforded the German company very strong competition against the Cunard Line's Mauretania and Lusitania.

The highest bid that has been made for the purchase of the Leviathan was that of the France-Canada Steamship Company (\$3,000,000), but the

bid stipulated that the U. S. Shipping Board lend the company \$6,000,000 for reconditioning purposes. Captain W. J. Thompson, of Philadelphia, also bid \$3,000,000. Both bids were refused.

St. Louis "Own Your Home Exposition"

The first "Own Your Home Exposition" to be held in St. Louis will open its doors at the Coliseum April 25 and remain in session through May 1.

The exposition is given under the auspices, direction and control of the Building Industries Association of St. Louis. It will show the latest developments in building homes, from the modest bungalow to the pretentious mansion, and the progress also in the construction of stores, office buildings, schools, garages, etc. There will be plaster models, photographs, pictures and plans of model homes, interior and exterior, and the exhibits will embrace all manner of building material—in fact, everything that goes to make the home beautiful, attractive, inviting and comfortable.

The program each day will consist of addresses on how to plan, finance and build a home; and there will be discussions by leaders of civic, commercial and patriotic organizations and women's clubs on the advantages of home-ownership. Plans will be shown of all manner of homes, and there will be exhibits of model dining-rooms, kitchens, bathrooms, sleeping porches, and all that is new and most scientific in heating, ventilation, drainage, etc. Attention will be given also to the economical and artistic furnishing of the home—the color effects, arrangement of furniture, lights and hangings. Arrangements have been made to show plaster models of homes faithfully produced in every detail, showing how it is possible under this plan for the prospective home-builder to see his house before it is built, and how each room will appear, and how the house with its background and surroundings will look.

The purpose of the Exposition is to inspire every visitor to it with the love of home and implant the desire to build and own a home. Home ownership is admittedly the foundation-stone of the structure of our national life. Love of home and the ownership by Americans of individual homes is what has made America the world's richest, strongest and freest country. St. Louis has a national reputation as a city of homes. It is believed one of the results of the Exposition will be to disseminate more widely the sentiment for home building and home ownership among our citizens.

It is believed that the result of the Exposition will be to stimulate building in all lines.

For information, address "Own Your Home Exposition," R. L. Burch, Managing Director, 715 Equitable Building, St. Louis.

Portland, Ore., to Get City Plan

Traffic congestion on the streets of Portland have forced a more carefully prepared street and boulevard system. Under the direction of Charles H. Cheney, consultant to the Portland City Planning Commission, this city has now completed a comprehensive plan for permanently handling traffic.

The 34th Annual Chicago Architectural Exhibit—1921

It is with a distinct sense of disappointment that one concludes an inspection of the 34th annual Chicago Architectural Exhibit, on view at the Art Institute from March 8 to April 5. The purpose of such exhibits is primarily to educate the general public to an appreciation of architectural service and to offer an opportunity for architects to study the works of their fellows.

Architecture is the greatest of all arts that employ the use of material things, painting, sculpture and the handiwork of craftsmen being secondary in a marked degree. In this exhibit the architectural element is only about equal in interest and importance to the case enclosing artistic pots, jugs and what-nots; fabrics, furniture and miniature works of sculpture. An architectural exhibit should be overwhelmingly architectural and of dignity worthy of greatest efforts. Granted that the past few years have been lean ones in the architectural sense, there is always an available store of older work that possesses enough merit to interest and educate the public. Last year's exhibit had a room devoted to the works of a period when Chicago architects gave promise of great influence in the development of American architecture, attracted much attention and received favorable comment in the daily press. Those in charge of the current exhibit have seen fit to ignore much that is distinctive of Chicago and worthy of a world's attention.

The catalog does not indicate what organizations or committees are responsible for this exhibit. It is scarcely worthy of the two architectural organizations and the draftsmen's club of Chicago, architects generally and of Chicago.

The great plaster model of the Bahai Temple attracts the attention of the curious, its engineering and architectural shortcomings being readily apparent to the critical observer.

The work of architectural schools is characteristically represented by the Carnegie Institute, Chicago Art Institute, Harvard University and the Uni

versity of Illinois. Some original sketches by Otto R. Eggers, reproduced in and exhibited by THE AMERICAN ARCHITECT, attract attention by their excellence of and the method of rendering.

The Calder Committee Suggests a Remedy for Housing Shortage

The necessity for action by the Government in a movement for the erection of homes throughout the country, and especially in overcrowded centres of population such as New York, is urged in a report on the situation made public by the Senate Committee on Reconstruction and Production, of which Senator Calder of New York is Chairman.

Conditions as to scarcity of housing in the larger cities throughout the United States are set forth with much detail.

"It was a national, not a local, emergency which caused the shortage of homes," says the report, "and the shortage of homes in itself is a national as well as a local emergency, the result in large part of the operation of conditions which are nation-wide—in part, indeed, the direct result of Federal legislation."

In summing up, the committee holds that the great needs are "better transportation, abundance of fuel, home credits or loans and full information on the best methods of construction and city planning." The ten pieces of legislation recommended are as follows:

1. A bill to establish in the Department of Commerce a division for the gathering and dissemination of information as to the best construction practices and methods, technical and cost data and matters relating to city planning, etc., in order to encourage standardization and improved building practices throughout the country.

2. A bill to provide for the gathering and publication by existing governmental agencies of current facts as to production, distribution, available supplies, standards of quality, costs and realization of coal.

3. An amendment to the Transportation Act directing the Interstate Commerce Commission not to declare without hearings an emergency which will give preference of priority in transportation.

4. An amendment to the Federal Reserve Act to permit the Federal Reserve Board to direct the use of savings and time deposits of national banks for long-time loans, this giving such deposits greater security and supplying a source of long-term money for home building.

5. A home loan bank bill to provide for district home loan banks, which may sell under Federal supervision bonds secured by the aggregated loans deposited by the member banks.

6. An amendment, limited to five years, to the revenue act of 1918 to provide for the exemption from excess profits and income taxes of the profits on sales of dwelling houses where such profits, plus an equal amount, are reinvested in dwelling house construction.

7. An amendment to the revenue act of 1918 to exempt from taxation interest on loans up to \$40,000 on improved real estate used for dwelling purposes when such loans are held by an individual.

8. An amendment to the revenue act of 1918 limiting the taxation of profits from the sale of capital assets by providing for their taxation as of the years of accrual rather than as of the year of their sale.

9. An amendment to the revenue act of 1918 to limit the surtax upon saved income to an amount not in excess of 20 per cent. of such income.

10. An amendment to the Postal Savings law increasing the limitation on deposits as to amount and time and authorizing the rate of interest to be changed from time to time and providing for compensation of postmasters for their extra duties.

The report takes a firm stand against national, state or local governments attempting to relieve the housing situation by the granting of subsidies or by the erection of structures at governmental expense.

R. T. Crane Buys Westover

Historic James River Mansion Was Home of Richmond's Founder

Mrs. Clarice Sears Harrold Ramsay has sold historic Westover, on the James River, to Richard T. Crane, United States Minister to Czechoslovakia.

Westover was the home of William Byrd, who founded and laid off this city. The house, built of English material, is 200 years old, and is said to be the best preserved of all the colonial mansions in Virginia. It takes its name from Henry West, fourth Lord Delaware, and governor of the colony of Virginia, and was selected for him by his brother, Capt. Francis West, in 1619.

To Restore World Trade

At the first meeting of the International Chamber of Commerce, which is to be held in London during the week of June 27, the general subject will be "The Restoration of the World's Commerce." There will be general sessions and group meetings for the detailed discussion of economic problems in the fields of finance, ocean and land transportation, communication, production and distribution, and the restoration of devastated areas.

The American Committee is now engaged in selecting representatives to speak for the United States on the various topics and is giving consideration to

the personnel of the different committees. At the annual meeting of the Chamber of Commerce of the United States in Atlantic City, April 27-29, plans will be perfected for American participation in the London conference.

City Planning in Kansas

The City Planning Commission of Kansas City, Kan., is just now engaged in evolving a suitable city plan.

About the first thing such an organization must do is to make a fundamental study of conditions as they are in a city. It must ascertain what buildings and other forms of property are to be found in the city; what use is being made of this property; what area is occupied by the buildings; what vacant ground there is, and especially what the trend of development—commercial, industrial, residential—appears to be in any district. The conditions that are found to exist must be illustrated in drawings that will reveal concretely and at a glance what is going on as the city develops in its own haphazard way, with many conflicting influences at work in the process.

This is the kind of thing the Kansas City, Kan., commission is now doing. It is work that requires time. But definite and valuable results from city planning depend largely upon the thoroughness with which it is done.

1920 Fire Loss Third Largest on Record

The losses by fire in the United States during the year 1920 reached a total of \$272,075,000 as compared with \$219,571,000 in 1919, and \$274,456,000 in 1918. The December loss record, \$33,720,000, the heaviest monthly loss of the year, swelled the year's total to within slightly less than \$2,000,000 of the 1918 loss, thus making the 1920 record the third largest ever recorded in the United States, being surpassed only by 1918 and 1906, the year of the San Francisco conflagration.

Nebraska A. I. A. Holds Annual Election

At the third annual meeting of the Nebraska Chapter, American Institute of Architects, held recently in Omaha, H. W. Meginnis of Lincoln was elected president for the coming year. C. W. Steinbaugh of Omaha was elected vice-president and J. D. Sandman of Omaha was elected a new member of the executive committee. The meeting was preceded by a dinner which was held at the University Club. Alan McDonald, retiring president, was toastmaster.

Personals

Kendall, Taylor & Co. have moved to 142 Berkeley St., Boston.

Duhring & Ziegler, formerly of Bailey Bldg., Philadelphia, have removed to 1309 Locust St.

Robert Eisenschmidt, Mimnaugh Building, Columbia, S. C., desires catalogues at this address.

Edward Thal and Steve M. Jokel have moved their offices to 329 Summit-Cherry Block, Toledo, Ohio.

James Camassa is resuming practice at 196 Hanover St., Boston, after interruption for war service.

A. M. Ruttenberg, architect, has removed his office from 4706 Winchester avenue, Chicago, Ill., to Room 209, 105 North Clark street, that city.

John H. Graham, formerly at 1836 Euclid Ave., Cleveland, has formed John H. Graham & Co., with offices at 8201 Cedar Ave., Cleveland.

Clarence T. Meyers, architect, and Kenneth D. Coffin, architectural engineer, have organized at 412 Traction Terminal Bldg., Indianapolis, Ind.

Benjamin, Robinson & Benjamin, architects, formerly of 904 Grand Rapids Savings Bank Bldg., have moved to 37-38 Wenham Bldg., Grand Rapids, Mich.

Damon, O'Meara & Hills, architects, are now operating offices in Suite 1123-1124 Merchants Bank National Bldg., St. Paul, Minn., and 19 East Mason Bldg., Ft. Dodge, Ia.

J. C. Legel & Co. announces the opening of an office for the practice of architecture at 511 Wilson Bldg., Clinton, Ia. They are desirous of manufacturers' catalogs and samples.

Alexander B. Trowbridge and Frederick Lee Ackerman desire to announce that the partnership of Trowbridge and Ackerman, architects, has been dissolved. Mr. Ackerman will complete the unfinished work of the firm, and will continue the general practice of architecture at 25 West 44th St. under the name of Frederick Lee Ackerman, architect.

Mr. Trowbridge will continue his services as consulting architect to the Federal Reserve Board, Washington, D. C., and to the Federal Reserve Bank of New York, with offices at 120 Broadway, New York. At the expiration of this engagement, he will open new offices for a specialized practice as consulting architect.

The Metropolitan Life's Loans

An Interview with Walter Stabler, Comptroller of the Metropolitan Life Insurance Company—Lends Only on New Houses or Projects—\$2,000,000 Loaned in One Week—Present Demand Indicates Heavy Building Schedules This Year

WHAT is your company's method of placing loans, and what sort of loans do you deal with mostly," was asked Walter Stabler, Comptroller of the Metropolitan Life Insurance Company, by a representative of THE AMERICAN ARCHITECT.

"The Company," Mr. Stabler answered, "appoints a local bank, trust company or mortgage guarantee company as its representative for the making of loans on new small dwellings and on new moderate priced apartment houses."

"Are loans for remodeling work placed in the same way," was asked.

"Just now we do not place a loan on any sort of remodeling work, or on anything but new operations," Mr. Stabler answered. "The loans on new dwellings must not exceed \$5,000 nor be less than \$2,000. The loans on apartment houses depend upon their size and value.

"The company," Mr. Stabler emphasized, "does not entertain loans on houses that have been finished and occupied for some time, as loans of this kind do not add to the housing accommodations of the nation. No loans are made at more than 50 per cent. of the land value and the construction cost of the buildings, omitting carrying charges, overhead or profit. They are made for fifteen years at current interest rates. Interest is paid semi-annually, and on every interest date a 3 per cent. instalment is paid on account of the principal. All payments are made in New York funds, at par. The banking representative collects interest and instalments, looks after payments of insurance and taxes and remits twice each year to this company the amount collected. For this service the bank, in some cases, receives one-half of one per cent. of the interest, provided we receive not less than 6 per cent. net, and in other cases a commission is charged the borrower in the beginning to pay for the services of the bank. The representative must either guarantee absolutely the payment of the principal and interest to the company, or it must agree to repurchase any of the loans that become in default."

WHERE large employers of labor are desirous of building houses to sell to their employees," Mr. Stabler continued, "a very similar arrangement can be made. In such cases, the employer takes the place of the banking representative. He builds the houses, and when finished, the company takes over

the loans at figures to be agreed upon, or which may have been agreed upon in advance of construction. The employer then collects the interest and instalments, frequently by monthly or semi-monthly payments, remitting to the company semi-annually. The employer either guarantees outright the payments of principal and interest, or agrees to repurchase any of the loans with which there is trouble."

"Do employers charge for this service?" Mr. Stabler was then asked.

"In most cases," he replied, "the employers make no charge for services in caring for the interest and instalment payments. In other cases, they charge one half of one per cent. to the borrower, but a majority of the employers feel that the building and financing of such houses is just as necessary a part of their business as the factory buildings that shelter their plants and operators.

"They realize that they cannot retain capable working people in their employ unless they are comfortably housed, and as soon as a man has bought a home he becomes an active citizen in the community and has a stake in it, differing only in size from that of his employer. It is the invariable rule that in cases of labor depression, employers will hold on to men who have purchased their homes and are rearing families and let go the men who have no such interest in the community. In other words, it has always become true that a working man who buys a home in this way, from an employer, has pretty nearly an insurance against unemployment. This feature should be more definitely placed before manufacturers and working men as it certainly means an amount of co-operation that is extremely valuable to both sides."

"Where have you made loans of this kind, Mr. Stabler?"

"The company has made about 5,000 loans of this kind," he replied. "The beginning of such operations was at Akron, Ohio, with the Goodyear Tire & Rubber Company and the Firestone Tire & Rubber Company. Each of these companies built about 900 houses, which were almost all sold to their employees. They have both been very unusual housing developments and successful from the start, as all houses built were quickly taken up by the better class of clerks and working people. Reports received from there show that the house-buyers are still at work, while those who have been discharged are more of the floating type.

“THE Metropolitan Life has gone into this business with the sole desire to assist manufacturers and communities to produce necessary houses, believing that the emergency which exists should be relieved by institutions which handle the savings of the people, particularly life insurance companies and savings banks. Both the life insurance companies and the savings banks obtain a great deal of their money from the working people and it is the working people who are suffering most from the scarcity of houses and from high rents.”

“Is not this method entirely contrary to the company’s usual plan of investing?”

“Yes. Until lately, the company preferred only loans in large amounts and centrally located in the business sections of the large cities, but loans of that kind do not help the housing situation and the Company’s Officers and Directors felt that in this emergency the company should use its large funds to assist, so far as it could, in producing more houses and particularly homes of moderate costs. It is establishing these loan agencies as rapidly as possible and already has the plan in operation in about eighty cities. With the coming of Spring, and with the probability that the demand, which is now strong, will be even stronger, the company hopes to be in a position to take care of every suitable proposition of this kind so far as its funds will permit.”

“You say the demand is now strong?”

“Yes. Great interest is being shown in real estate loans. We recently placed \$2,000,000 worth of loans in one week.”

The Building Situation in the Middle West

(By Special Correspondence to THE AMERICAN ARCHITECT)

CHICAGO, April 11.—The building tie-up in Chicago seems, finally, to have simmered down to a single issue—that of labor costs. The contractors of the city, through their association officials, have presented to the building trades union official a proposal regarding a new wage schedule, and this proposal is providing the crux of the situation. The contractors want union builders to accept a wage of \$1.00 an hour instead of the \$1.25 schedule which the union carpenters insist upon for the present season. The contractors ask a reduction of from \$1.00 to 70 cents per hour in the case of common labor on construction work.

This proposal was made several days ago and was at first flatly rejected by the union officials. Later, it was decided to submit the issue to the workers themselves on a referendum, and that is in process at the time this is being written, with superficial indications, at least, that the proposition will be de-

clined, even though something like 45,000 union carpenters in Chicago are not employed at their trade because of the dullness in building.

It would seem to be a contest of wills between union labor and those interests which are fostering building projects. Contractors say that building cannot begin until lower construction costs are made possible by a decline in labor prices, and to emphasize this argument they point out that at least \$150,000,000 in contemplated building is being held up in Chicago pending an adjustment of wage difficulties.

It is generally felt that a concession in the matter of labor costs will start the ball rolling without delay, much of the preliminary planning having already been completed. If union labor declines to accept the proposed wage cut, there are rumors that contractors will attempt to establish an open shop program, putting the wages even lower than the present proposal which is being considered by the unions.

That labor is proving the element at which building is now balking is evidenced in the case of the \$3,000,000 West Side postal station, which the railroads propose to build and lease to the Government. Bids were received on that structure this week. Labor estimates on this important item of construction have been figured on the revised schedule of \$1.00 an hour for union skilled labor and 70 cents an hour for unskilled union labor. If the wage schedule becomes effective, the work can proceed on the estimates which have been submitted; unless the revised schedule becomes operative, the work will be held up for an indefinite period.

While less definitely stated, that feeling prevails in relation to practically all important building construction now on the boards or in more distant contemplation in Chicago. Such building as is now in progress is mainly confined to small homes and apartments of the lesser grade. There are no important projects now under way except the Federal Reserve Bank building, upon which construction is proceeding slowly.

While building permit totals have continued to swell, it is now realized that these permits are so far preliminary to actual work that they may, on occasion, be practically without value as indicating construction activity. Permits have been issued, for example, for several large and important structures upon which no actual effort has yet been expended.

Arthur M. Evans, who writes interestingly and authoritatively on economic subjects for the *Chicago Tribune*, estimates that not less than \$100,000,000 in construction is now contingent upon an acceptance by the unions of the new wage proposal. He even goes so far as to set down a number of important projects now in the planning stages which are being

held up awaiting a more favorable market for labor and materials.

There are, of course, many more or less important buildings under contemplation, to say nothing of the very large number of homes, which would add materially to the totals indicated by Mr. Evans. Once the building boom gets fairly under way, it is conceded that the enthusiasm of building will sweep over the city and create an additional interest in such work.

The mere matter of needed homes is sufficient to provide the nucleus for a considerable building boom, without taking into consideration the immense volume of public and semi-public construction.

According to Charles Bostrom, who as city building commissioner has recently completed a housing survey of the city, there are more than 100,000 Chicagoans without places to live. Mr. Bostrom's totals lead him to announce that there are 323,411 buildings in Chicago used for living purposes. In these buildings 607,370 families must find quarters.

The housing problem is being met as best it may through the "doubling up" process, which is neither satisfactory nor permanent. The pressure from within will be sufficient to start the home-building program just as soon as conditions become even fairly favorable. Mr. Bostrom estimates that not to exceed 125,000 Chicagoans own their homes.

While the main issue of interest is the contention between contractors and labor, the week has not been without interest in other matters of construction import.

Announcement has been made of the plan for constructing 100 brick bungalows in a new addition on Irving Park Boulevard, on the city's northwest side. These are to be of moderate price and are to be ready for occupancy on August 1.

The Lumbermen's Association has recently constructed its one-day house as an example of the lowered cost of frame construction buildings. The work was started at 7 A. M. and the construction, roof, floor and exterior finish were completed by quitting time. The mayor of the city attended the building bee and a great stir was made about it from a publicity standpoint. The building will not, however, be ready for occupancy for thirty days.

Encouraging information comes from leading Chicago bankers of a growing interest in real estate

mortgage investments. They believe that money will be available for all desired building, as soon as labor and material costs have been stabilized. Such money for building, these estimate, will not cost more than $6\frac{3}{4}$ per cent.

The legislative investigation of the alleged building clique in Chicago continues and out of it is apt to come some new legislation on building. In the new legislation it is hoped to write insurance against building shake-downs, through which crude but effective method building costs have been greatly increased in Chicago in recent years.

The agitation regarding labor costs has directed attention away from the costs of lumber and minor materials. The range of prices, however, has not materially varied from those of a week ago. Present quotations in the Chicago market are:

Yellow Pine: B. & B. 1-in., \$95 to \$130, depending on thickness; 2 x 4, No. 1, 10 to 16 ft. length, \$51 to \$53; 2 x 6, \$48; 2 x 8, \$50; 2 x 10, \$53; 2 x 12, \$55; 13-16 x 3 1-4 z & b flat flooring, \$85 to \$90; 1 x 6, No. 2 common, \$48 to \$90. *Douglas fir*: 2 4 S, in sizes up to 12 x 12, in length up to 32 ft., \$65 to \$70; 14 x 14, \$68 to \$73; 16 x 16, \$72 to \$75; 18 x 18, \$75 to 80. *Hard Maple*: Four 1-4 No. 1 and 2, \$135; select, \$120; No. 1 common, \$100; No. 2 common, \$65; No. 3 common, \$32. *Birch*: Four 1-4 No. 1 and 2, \$160; select, \$133 to \$138; No. 1 common, \$95 to \$100; No. 2 common, \$60 to \$65; No. 3 common, \$40. *Red Gum*: Four $\frac{1}{4}$ No. 1 and 2, \$150; No. 1 common, \$90 to \$92; No. 2 common, \$45.

Face Brick—Standard, vitrified red, \$32.00@34.00; Smooth, Indiana red, \$38.00@40.00; Smooth, Ohio red, \$38.00@40.00; Smooth, Pennsylvania red, \$46.00@48.00; Smooth, buff, \$45.00@47.00; Smooth, gray, \$47.00@49.00; Rough, buff, \$44.00@46.00; Rough, gray, \$47.00@49.00; Variegated, rough texture, \$34.00@49.00.

Common brick, \$13.00 to \$16.00 per M. Portland cement, \$2.25 per bbl. Torpedo—Lake and bank sand, \$3.50 per yd. Crushed stone, gravel screenings, \$3.50 per yd. Hydrated lime, Ohio, paper, \$21.00 per ton. Hydrated lime, Ohio, cloth, \$29.00 per ton. (Includes sacks at 30c. each). Hydrated lime, Wisconsin, paper, \$19.00 per ton. Bulk lime, \$1.65 per ton.

Building Conditions on the Pacific Coast

(Special Correspondence to THE AMERICAN ARCHITECT)

SEATTLE.—The extensive road building program projected on the Pacific coast for this year will keep cement prices strong, with a constantly ascending tendency, according to jobbers of these materials. Architects who have been making some investigations of their own find the same conditions. Contractors in searching out essential costs for the season's work say that undoubtedly those who expect to buy cement at lower figures than prevail today will be disappointed. As all other materials but lumber are expected to decline builders are not showing any repressive tendency in regard to plans for the season.

Stocks of sheet metals used in the building trades have been somewhat accentuated this week, largely on orders previously given which could not be cancelled at the mills. Warehouses of the Pacific coast now contain enough of a supply of sheets, black and galvanized pipe and nails to run through the second and into the third quarter of the year should building projects remain at their present proportions. The field is being scoured carefully by the building hardware jobbers for prospects, and these are to the effect that there has been a noticeable increase extending back for 15 to 30 days in the plans in the hands of architects for remodeling and new construction.

Probably the feature of the week in the metal line is the forecast from the East that the Steel Corporation is to make some price changes this month, and these changes are expected to be lower.

Manufacturers of metal lath have evidently seen the change in sheets coming, for they have been offering some new downward price revisions. Roofing is steady. Jobbers are being besieged with offers, and there can be no shortage this season as the situation is viewed here.

Lime manufacturers are able to hold prices stationary, although the capacity on the Pacific coast when at the full is 60 per cent. more than can be absorbed in any possible demand. Quotations at the warehouse are \$2.75 per barrel. Plaster has been coming from the East, but prices are stationary. Warehouse quotations are \$8.

The fir lumber market has evidently reached the turn. Common dimension is selling at the mills at \$1 higher. Stocks are badly broken, and wholesalers, in filling cars of mixed orders, cannot complete without considerable searching. Finishing sizes are steady. Mill capacity in operation in the West Coast fir territory today is 60 per cent., with promise of an increase to 75 per cent. within the

next 10 to 20 days. The spring and summer demand is expected first to force accumulated orders in the southern pine mills, after which the bulk of orders will gradually drift to the West Coast fir territory. The railroad rates, although lower, continue to favor the pine mills. A vigorous fight is being made by lumber shippers here for a \$15 or \$16 rate to New York, and prospects seem to be fair for fulfillment of this hope. There is much discontent over light cargo offerings to conference intercostal lines, and the conference is being held together on the present \$20 rate with great difficulty. Opening of the Atlantic seaboard markets to fir lumber would establish three-fourths of the consuming territory formerly held by fir mills although in an entirely new field, but the effect would be to strengthen prices at the mills and start a vast industry into immediate action.

Production of fir for the week was 42 per cent. below normal. Orders in the rail trade, or for eastern building construction, were 1,269 cars, with unfilled orders for the same territory of 3,447 cars. Average prices for flooring at the mills were \$46, of ceiling \$18 to \$21, drop siding \$21, boards and shiplap \$12.50 to \$13, dimension \$10.50 and plank and small timbers \$16.50.

Lockwood Committee to Get Loan Facts

Questionnaire Sent by Committee to 253 Institutions in New York City—Expectation That Witnesses Will Be Called to Tell Experiences in Seeking Funds

The Lockwood Committee, of the New York State Legislature, which has been investigating and will continue to investigate the housing and building situation in New York City, has sent to 253 money lending institutions of that city a questionnaire designed to secure complete information upon the causes for the poor lending market on housing construction. The questionnaire is returnable in not more than 20 days under penalty of formal subpoena, and demands that "an itemized statement showing the nature, amount and recipient of each and every charge for services and disbursements, directly and indirectly paid by the borrower in connection with every real estate mortgage loan transaction affecting property in the State of New York" in which the institutions affected "participated as lender between January 1, 1916, and March 10, 1921" be shown.

Witnesses will probably be called before the committee to tell of their difficulties in obtaining building loans.

Grantsville No. 2365



CLOISTERS, CHURCH OF ST. BERTRAND, COMMINGES, FRANCE

THE AMERICAN ARCHITECT

VOL. CXIX

WEDNESDAY, APRIL 20, 1921

NUMBER 2365

Thirty-sixth Annual Exhibition, Architectural League of New York

THE Architectural League of New York, in its 36th annual exhibition now open in the new wing of the Metropolitan Museum of Art on Fifth Avenue at 79th Street, has set a record of achievement in architectural exhibitions that it will be difficult for other architectural societies to equal this year.

This exhibition certainly marks the high spot in a showing of architecture and the arts allied to it, and has been so dextrously arranged, so beautifully assembled that even the most captious critic may find nothing to criticize adversely.

Nothing daunted by an unfortunate fire which last year destroyed the exhibition almost at the hour of its opening, the League has set about the preparation of the present exhibition with most wonderful energy and perfection of team work that seems to characterize this progressive organization.

It was the Architectural League that first recognized the value of the work of the various building trades and crafts to which architecture was allied, and as far back as three years ago began to encourage these allied elements to participate in their exhibition. The culmination of this very valuable team work is to be found in the present exhibition.

Perhaps the League is the first society to recognize thus formally that while architecture is the highest development of all the arts, it is also, in some of its activities, a very highly developed business. We are, therefore, not surprised to find in this exhibition groupings of exhibitions of building and contracting firms, the splendidly designed and decorated interiors of representative decorators, and a wonderful display of craftsmanship in metals, glass

and textile fabrics. All of these have been so well grouped, so admirably placed, that the value of the architectural exhibit is enhanced, and its relation to the other things shown, most splendidly set forth.



A MEMORIAL GROUP
ROBERT AITKEN, SCULPTOR

36th Annual Exhibition, Architectural League of New York

Copyright, 1921, The Architectural & Building Press (Inc.)

WHEN one considers the lean years from which we are just emerging, the retardation of building and the present stagnation, he will be impressed by the thoroughness with which the League has searched the field for new and important work, the splendid manner in which it has either been photographed or drawn, and its placing.

Probably no better opportunity could be offered for the grouping of an exhibition, such as the present one, than in the not quite finished wing of the Metropolitan Museum. This wing lacks considerable of completion, many of the structural elements

THE AMERICAN ARCHITECT

are still in sight, and the floor has not been laid. The walls are plain, uncovered brick, and the whole effect when the League took over this immense space was one of absolute incompleteness. By a very fine



GLOBE SUNDIAL

H. W. FRESHMUTH, SCULPTOR

36th Annual Exhibition, Architectural League of New York

artistic appreciation of the possibilities to be achieved, the large gallery, with its enormous height and splendid scale, has been made a bower of beauty.

One may study the general street effect of the new zoning regulations in New York in the designs that are exhibited of buildings already completed, and other important structures either under way or not yet begun. Noticeable are the addition to the Standard Oil Company's building on lower Broadway, the Fiske Rubber Building near Columbus Circle, the Borden Building, the Cunard Building, a close neighbor to the Standard Oil Company, and other structures in nearby cities where zoning regulations have either been enacted, or where the style of design inaugurated in New York has been in a measure employed in other cities.

More prominently and owing to the possibilities of the exhibition room, more beautifully shown than in any other exhibition, is the sculpture, notable for its well-considered placement. In fact, the division of sculpture is so important and so very dignified that it would constitute a worth while exhibition in itself.

This year the mural painters have had better opportunity to display their work than ever before, and they have taken advantage of it so that the walls of the various galleries are ablaze with beautiful colors, and the work of the mural painter has been splendidly selected and hung.

Also, this year, as did last, accents the steady upbuilding of the country estate both in the architectural treatment of the buildings and the beautiful landscape architecture development that has been quietly going forward, and that has only recently reached the state where its illustration might be shown to advantage.

The number of pretentious houses that are shown are of the very best types of domestic architecture, and prove the contention that the architects in this



PANEL IN DOORS OF THE STANFORD WHITE MEMORIAL, NEW YORK UNIVERSITY

A. A. WEINMAN, SCULPTOR

36th Annual Exhibition, Architectural League of New York

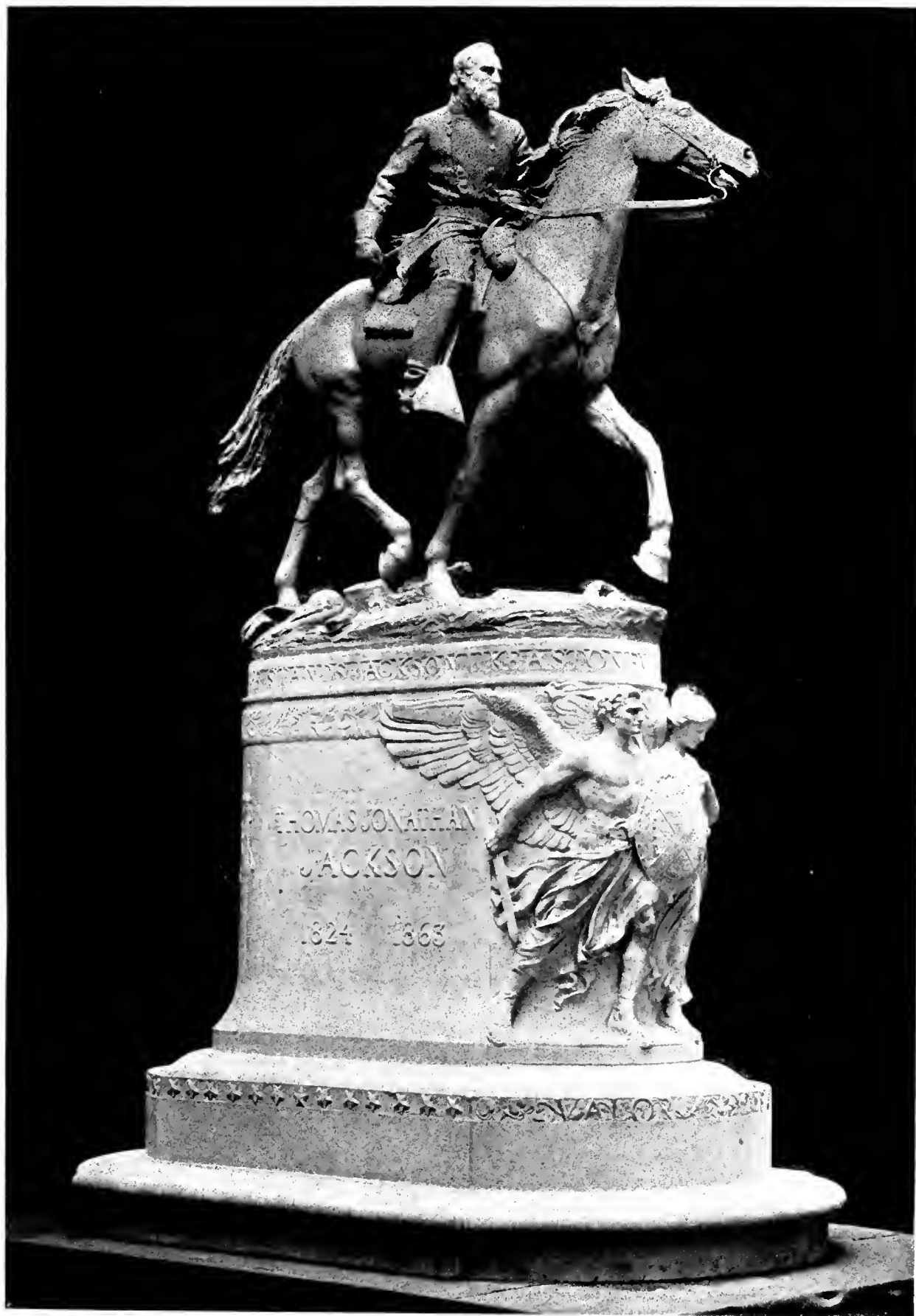

MONUMENT AT CHARLOTTEVILLE, VA., TO "STONEWALL" JACKSON

CHARLES KECK, SCULPTOR

36th Annual Exhibition, Architectural League of New York

THE AMERICAN ARCHITECT



PEDIMENT

36th Annual Exhibition, Architectural League of New York

SHERRY FRY, SCULPTOR

country are educating their home-building clients how to spend their money properly.

TO set down in detail every good work in this showing of architecture and the allied arts would be practically to reprint a list of the exhibitors. Nor would it be possible to describe at length, or give any sort of an accurate idea as to the way the various committees have transformed this partly completed gallery into a very garden of the arts. The whole

thing must be seen to be appreciated. There is one thing, however, that is quite certain, and that is that the League, in carrying to execution so dignified a showing of architectural work, has put the entire profession under an obligation because it has demonstrated the right of architecture to its high position as an art, and at the same time has also demonstrated how practical architects may be when they set about anything of this nature.

The opening of the exhibition took the form of a



GEORGE ROGERS CLARK MONUMENT

ROBERT MITKEX, SCULPTOR

H. VAN BUREN MAGONIGLE, ARCHITECT

36th Annual Exhibition, Architectural League of New York



IN THE GARDEN OF S. H. P. PELL, FORT TICONDEROGA, N. Y.

ALFRED C. BOSSOM, ARCHITECT

THE AMERICAN ARCHITECT

pageant arranged by J. Monroe Hewlitt, the president of the League. This pageant consisted of a series of living pictures in pantomime of ancient Babylon during the days of Darius. The drama of



PIONEER GROUP. MONUMENT AT GERMANTOWN, PA.

ALBERT JAEGER, SCULPTOR

36th Annual Exhibition, Architectural League of New York

Daniel, the golden image and the lions, was used and the argument was the Scriptural account. It was called on the program "The Den of Lions; a Rhythmical Masque of Babylon the Great in the Manner of Assyrian Faience."

Shadowy suggestions of the Babylon of Darius passed before the curtain as Charles L. Safford chanted in excellent baritones the opening passages from Scripture. The whole thing was a scene of impressive beauty upon a scale that would have fitted the Metropolitan Opera House.

Mr. Robert Aitken, sculptor, was the King, and Miss Valodia Vestoff, one of the few professionals in the cast of 200 actors and actresses, was the Daniel. The music for the pageant was especially composed or arranged by Mr. Kenneth M. Murchison, and the whole presented under the direction of Mr. Howard Greenley. A large orchestra and the mixed choir from Grace Church, Brooklyn, furnished the instrumental and vocal accompaniment.

An effort is being made to have the pageant re-

peated, if possible, for the entertainment of a larger public.

Before the close of the evening, Mr. Hewlitt, the president, announced the annual awards of medals and certificates, as follows:

In architecture, to Mr. Charles Z. Klauer; in painting, to Mr. Eugene F. Savage; in sculpture, to Mr. John Gregory, vice-president of the League; in native industrial art, a medal awarded for the first time, to Cheney Brothers for the best designs of dyeing and craftsmanship in silks; the Avery Prize in sculpture, to Mr. Leo Lantelli, and in landscape architecture to James L. Greenley. Mr. Hewlitt also announced the following awards offered in a competition by the Eastern Terra Cotta Company: First, to Messrs. P. Harold Sterner and Salvatore Grillo; second, to Messrs. Grenville Rickert and Benjamin Moscovitz, and third to Francis J. Creamer.



"IMP"

U. CRENIER, SCULPTOR

36th Annual Exhibition, Architectural League of New York



FOUNTAIN

CHARLES KECK, SCULPTOR

36th Annual Exhibition, Architectural League of New York

THE AMERICAN ARCHITECT

THE Year Book of the League, which is the catalog of the exhibition, is, like the exhibition, the best the League has ever produced. It is a record of the best development in architecture during the past two years. It has been very carefully prepared, and its mechanical excellence will make it a desirable book for every library. Copies may be had from the offices of the League, 215 W. 57th Street, New York.

In concluding a necessarily brief and sketchy reference to so important an undertaking, it is fitting that mention should be made of the unselfish dona-

tion of time and professional skill on the part of the League members. In assembling and placing so large an exhibition, probably the largest the League has ever held, the great amount of detail constituted a long and laborious undertaking. In doing this very large work, the various committees have placed not only the League but the entire profession of architecture under a very great debt, and they have accomplished what is a more important work—the upholding of every dignity that surrounds a dignified profession.



HOUSE OF MR. LAURENCE M. THOMPSON, MONTROSE, PA.

LEWIS E. WELSH, ARCHITECT

36th Annual Exhibition, Architectural League of New York



HOUSE OF MR. FERMAN YOUNKER, ELMSFORD, N. Y.

BUCHMAN & KAHN, ARCHITECTS

36th Annual Exhibition, Architectural League of New York

Architectural Quicksands

By CLINTON H. BLAKE, JR., of the *New York and Federal Bars*

THE STANDARD DOCUMENTS, CONTINUED.

ARTICLE 24 of the Standard Documents I have already referred to, in part, under the discussion of Article 5. The provisions of this article, whereby the various alternatives of estimate and costs, the unit price and the like are fixed, and the architect given authority to require an account of costs in such form as he may deem proper, are especially valuable and helpful and in line with a smooth working understanding between the parties. The clause seems to deal, however, with the situation where the change in the work has increased the cost, rather than effected a saving. While this is undoubtedly the ordinary effect of a change in plan, the contract should contain a proviso covering a credit to the owner for any saving due to changes. The opening sentence of Article 24 indicates that it is the intent that the Article shall cover deductions from the cost of the work as well as increases. This intent should be carried into proper effect in the body of the Article and the owner assured of a proper deduction, in cases where the change effects a saving, just as the contractor is assured of an increase where the change means an increase in cost.

The provision in Article 25, whereby the contractor must give notice of claims for extras is excellent. This Article, however, must be read in conjunction with the provision for arbitration to which I have already referred. In line with the feeling which I have expressed, regarding the arbitration clause of the Standard Form, I can not feel that it is advisable to leave claims for extras and changes so entirely to arbitration. Any savings effected by the changes in the plans the architect should certainly be able to certify accurately, and he should be equally able to pass intelligently and promptly on claims by the contractor for extras. I can see no good to be gained, and much harm to be done, by allowing an appeal to an arbitration board from his determinations, on items of this character.

Article 26 is directly in line with various suggestions which I have made in the earlier instalments of these writings and the provision requiring the contractor to submit the schedule of values of the various parts of the work and similar necessary information is directly in line with the idea of securing a proper statement covering the component parts of the job. If this data be intelligently and carefully made use of by the architect, it will enable him to conduct the work with a minimum of misunderstandings between the owner and the contractor, and a maximum of protection to the owner and to himself.

Article 29 I believe to be too narrow. The owner should be protected beyond any question against the filing of mechanics liens during the progress of the work. This article attempts to cover the point by holding up the final payment and the retained percentage until a release of the liens has been secured or the lien bonded. The article also provides for a refund to the owner by the contractor, on account of any lien remaining unsatisfied when the final payments to the contractor have been made. To give proper protection to the owner the article should be broadened, so as to enable the architect or owner to hold up the payment of any instalment, at any time, until any lien then existing has been properly satisfied or bonded. The owner should not be placed in a position where he is compelled to proceed with the work while there are liens on the property, and to depend merely upon his right to hold up the final payment, or the retained percentage. The lien might, indeed, exceed these amounts, so far as the wording of Article 29 is concerned, without giving to the owner any broader remedy than that specified therein.

Article 31 I believe to be too stringent as against the contractor. The question of patents is one which arose repeatedly, and was especially emphasized, in contracts between the government and various manufacturers and contractors during the World War. The general idea upon which Article 31 is based is good, viz.: that the contractor should protect the owner from suits based on infringements of patents, involved in the construction of the work in hand. The exception to this rule, which was quite carefully worked out in the case of the government contracts referred to is, nevertheless, I think, fundamentally fair and, in fairness to the contractor, necessary. This exception was carried into effect by the addition of a clause providing that the contractor should not be compelled to make good claims for royalties or license fees, in those cases where the particular patents, for the infringement of which such claims are made, are made part of the specifications on the insistence of the owner. If, for instance, a contract calls for certain construction in definite terms, without specifying a special process, the contractor should save the owner harmless, from claims by the owners of letters patent which he may infringe in working out this construction. If, on the other hand, the owner introduces into the contract the provision that certain work shall be done in accordance with a certain particular process specified, or that a certain type of concrete construction must be used, or a certain type of patented trim or the like, there is no

THE AMERICAN ARCHITECT

reason in equity why the contractor should be forced to make good, to the owner, claims made by holders of patents covering this special work. The suggested broader form of understanding on this point is fair to both sides. It protects the owner, where he should be protected, and it does not penalize the contractor on points which are not his fault.

In Article 38, a possible confusion may arise under the wording of the clause giving the contractor the right to stop work, if the owner shall fail to pay "any sum certified by the architect or awarded by arbitrators." Under the scheme adopted in the Standard Contract, the architect might certify certain sums and this certification might then be submitted, at the instance of the owner or at the instance of the contractor, to arbitrators. There should be a distinct interval of time intervening between the certification by the architect and the decision by the Board of Arbitrators. It is not clear, under the clause as worked, whether the owner would be compelled to make payment of the amount, within a certain time after the architect certified it, irrespective of the fact that an appeal from such certification had been made, or whether, where such an appeal is made, the obligation on the owner to make payment would not become effective until after the certification of the architect had been confirmed by the arbitrators, or a modified award on the item in question made by them.

In the last few pages, I have touched, necessarily briefly, on some of the points in the standard contract which seem to me to contain weaknesses and to require modification. Lest there be any misunderstanding of my feeling regarding the Standard Documents, however, I want, in closing the discussion regarding them, to emphasize again my feeling that their preparation and adoption has been of immense value to all of the trades involved, to the architect, and to the owner. The standardizing of the form of agreement, the careful work which has evidently entered into the preparation of all of these papers, the spirit of cooperation between the associations of the various trades, and the constructive work of American Institute, which have, together, made possible the adoption of the Standard Forms, are all deserving the warmest praise.

CONCLUSION.

In closing this series of rather informal discussions of the "Quicksands" which should be avoided by the careful architect, it may perhaps be helpful if I briefly recapitulate the more important points of caution which the architect should bear in mind, in the course of his dealings with his clients and others. The points which I would have the architect appreciate especially, are these:

The practice of architecture has a business side as well as an artistic side. Architecture is at once a fine art and a business. The architect owes it, not only to himself, but to his client, to appreciate the business side of his profession. He owes it to himself, because such an appreciation will cause him to arrive at a definite understanding with his client, which will save misunderstandings and expense. He owes it to the client, because the appreciation of it will enable him to handle matters, arising between the client and the contractor, on a business basis which will protect the interests of the client, and generally contribute to a satisfactory performance of the work involved.

The motto "Be definite," if lived up to by the practicing architect, will at once aid him in perfecting a smoothly working organization and, at the same time, prevent misunderstandings, disagreements and loss. Definiteness, so far as the relations with the client are concerned, means arriving at a proper and clear understanding with the client on all points, including the question of compensation and, preferably, the making of a definite contract of the character referred to in the earlier articles of this series. Definiteness, with respect to the contractor, means not only care in checking estimates and requisitions, and care in drafting and issuing certificates, but means also care in the dealings between the contractor and the architect.

By all means have in mind the fundamental rules at least of the law of agency. These rules are involved in the practice of every architect and are of material importance, at almost every point of contact, between the architect and the owner and the architect and the contractor. They are important, especially, on the questions of the authority of the architect to authorize extras, to make changes, to accept bids, to allow a departure from the terms of the written contract and all of the other and similar points which are involved, wherever the architect acts to any extent as the agent or as the spokesman of the owner.

Be diligent to arrange so that estimates submitted will be on a unit price component part basis, in such detail that you will be able to check up the costs and component parts of the work involved.

The architect is not simply the representative of the owner. He is called upon to act, time and again, in what is really a quasi-judicial capacity and he is under certain very definite obligations to the contractor. He must act with fairness to the latter, just as he must act with fairness to the client. He is much more the representative of the client than he is the representative of the contractor, but the fact that he is the representative of the client does not mean that he is not under certain obligations to the

THE AMERICAN ARCHITECT

contractor, in the exercise of the duties which his employment places upon him.

In dealing with business or municipal corporations or associations, remember that certain formalities are necessary to effect proper corporate or association action and, where the matter is of real importance, see to it that proper resolutions or other action is taken to make legal any authority conferred upon you by the corporation or association.

While I can not well overemphasize the importance which I attach to the recognition of the business side of architecture, I would again caution the architect against any mistaken development of this thought on his part, to a point which may place him in the position of being himself the contractor. I have not in mind, on this caution, the case of a firm deliberately entering a contracting business. In such a case, ordinary prudence would dictate the necessity of having some trained business man in charge of this phase of the firm's activities. What I have in mind is rather along the line of the cases which I have cited of architects involving themselves in situations where, with some show of truth, the claim can be advanced by the client, that they are contractors, where in reality they have never had the slightest intention of becoming contractors or of bearing any relation to the work in hand, other than the relation of architects in the ordinary sense.

The lien procedure in the various states is highly technical. The architect has a real and increasingly efficient remedy under the modern lien laws, but if he is to make proper and wise use of it, he should not endeavor to draft notices of liens himself, but should rather secure proper advice, so that he may be assured that his rights are adequately covered and protected.

I have endeavored, both in the present series and in my other writings, to bring home to the architect a sufficient realization of the more important legal pitfalls, involved in the practice of his profession, to enable him to sense the danger points as they arise. In a general way, with the more fundamental legal

principles affecting his rights and liabilities, in the practice of his profession, he will be able to appreciate, as situations arise, those points wherein a possible danger lies. An ability to do this will manifestly result in the heading off of disputes and other troubles, in the saving of future litigation and legal expense, and in the prevention of discord between the architect and his client and the client and the contractor.

While the purpose of what I have written is to lessen the possibility of difficulty and litigation, I would not have the architect endeavor to be his own lawyer. To make this attempt will unquestionably result in entirely unnecessary loss to him and in his becoming involved in difficulties which might easily have been avoided, by a very moderate dose of sound legal advice in the beginning. My hope rather is that, by an appreciation of the fundamentals involved the architect may, upon his sensing of a possible danger point, be thus forewarned and enabled to take up the point in question with his attorney and secure, in advance, and before it is too late, such advice as may be necessary to enable him to avoid the particular quicksand which lies ahead of him.

As was aptly said in the editorial comment in the July 28, 1920, issue of *THE AMERICAN ARCHITECT*, "The Mariner has his charts from which he may learn the location of rocks and shoals, of currents and trade winds. All these insure a safe and speedy voyage. But architects have available few of these helps and safeguards." The present articles will have served their very modest purpose, if they are instrumental in pointing out to the practising architect the more formidable of these rocks and shoals and currents and in indicating to him the course which he should take to avoid them and to secure the benefit of those favoring trade winds which will be induced by the practice of his profession on a basis of care, of definiteness, and of an understanding of the fundamental rights and obligations of architect, owner and contractor.



ENTRANCE DETAIL, GUARANTY TRUST CO., FIFTH AVENUE, NEW YORK
CROSS & CROSS, ARCHITECTS

36th Annual Exhibition, Architectural League of New York

*Pennsylvania Hospital,
Philadelphia, Pa.*

(See reproduction of original drawing by O. R. Eggers on opposite page)

The Pennsylvania Hospital, a detail of which is shown in the sketch by Mr. Eggers in this issue, is one of the most venerated and venerable structures in Philadelphia. Founded in 1751, largely through the efforts of Benjamin Franklin, it is maintained entirely by private subscription. It is the oldest institution of its kind in America.

In its architecture it follows closely the lines of the important buildings erected during our Colonial period.



WING OF PENNSYLVANIA HOSPITAL, PHILADELPHIA, PA.
THE AMERICAN ARCHITECT Series of Early American Architecture

488²

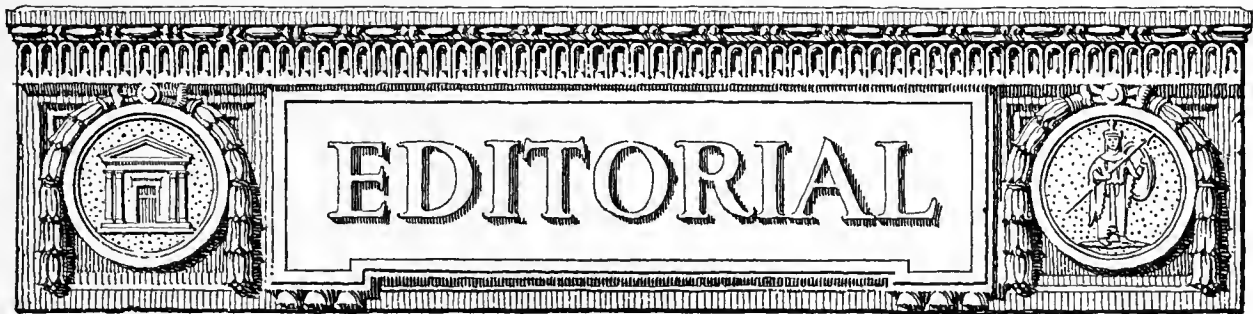

The League of New York Artists

STRANGE that the National Academy of Design, national as its name indicates, should leave it for a newly formed and local body of artists to undertake the work that might rightfully be considered that of the Academy.

The League of New York Artists has but recently come into existence. It numbers among its charter members men of national reputation in art, many of them Academicians. We learn from a circular announcing this organization that the object of the League is "to arouse the national government to the realization of the need of a Minister of Art with portfolio," and to give definite and concrete support to artists. Further, it is proposed to promote a more general and active interest in the creation of exhibitions. In short, the object of the League is the cultivation of the highest possible development of correct appreciation for art, and to place it under the control of the national government.

We have no charter of the National Academy at hand, but it is supposable that it was at the outset organized to promote, in the larger sense, just the things for which this newly formed League proposes to work. If the Academy were a less moribund organization, there would be no field for this newly organized League. If, on the other hand, the League faithfully carries forward the program it has outlined, what will be the status of the Academy?

The League of New York Artists further announces the purpose "to promote general and active interest in the creation of a large public exhibition building, which shall be worthy of the city and sufficient to house all the exhibitions of the various societies of art."

Why the League? Why not the Academy? For many years the Academy has been without an artistic home. The Vanderbilt galleries, never adequate, have been the only place wherein to house its exhibitions, and when last year these galleries were destroyed the Academy went to Brooklyn for wall space. Even this rude awakening, it seems, was but temporary, for an exhibition of the Academy has but recently closed in the rebuilt Vanderbilt gal-

leries. Meantime, the problem of the promotion of art appreciation in New York, which the Academy with its large fund might successfully solve by the erection of an adequate structure languishes. If the League with its membership of leading artists can create a fund for an adequate building, it will have established an art center in New York of far-reaching influence. The high standing and recognized ability of the men at the head of the League would seem to insure the best results.

Proposed Canadian Copyright Law

A COPYRIGHT bill, now passed to its second reading in the Canadian Parliament, appears to be class legislation in a most iniquitous form. If this bill becomes a law in Canada, it will result in the practical exclusion of every periodical published in the United States. It would permit Canadian printers, under a so-called licensing system, to appropriate and use without obligation of credit or acknowledgment, any matter published outside of Canada. It is a most adroitly drawn measure.

It is apparently intended to constitute a "retaliatory" measure, framed and put forward by organized Canadian printers, against the "manufacturing" clause in the United States copyright bill. Not content with the framing of a law so manifestly unjust and one which ignores the ruling of the Berne convention, there is, it appears, organized effort to make all second-class matter coming from the United States pay a postage of 15 cents per pound. Such a rate would practically act to exclude every publication in the United States.

There is neither sense nor reason in the enactment of the proposed legislation. It would be sure, in this country, to deprive Canadians of the bulk of their periodical and trade literature. Further than that it is not reasonable to suppose that this country would quietly submit to such action on the part of a country whose geographical boundaries are so closely interwoven with our own. Level-headed men in the Dominion and the United States should combat this proposed copyright legislation which is sure to be provocative of the most disastrous results.

Criticism and Comment

An Appreciative Letter from an Old Subscriber

Publishers, THE AMERICAN ARCHITECT:

Your request, of recent date, that as my relationship to THE AMERICAN ARCHITECT as a subscriber had now entered its thirty-fifth year, it would be of interest to the management to know what use and service the publication had been to me during these years, came to me as quite a shock for getting my copy of THE AMERICAN ARCHITECT has become as much a part of my life as partaking breakfast each morning, and I believe that I use them both, each in its own way, as a preparation for the work of the coming day.

While one may gain in a long life a great deal of valuable personal experience, that life cannot be so full of experience by itself, as that attained by contact with the experience of others through the means of a journal, such as THE AMERICAN ARCHITECT, for by that greater contact one's own personal experience is enriched and one's outlook and vision widened and broadened.

I may say that I have had most of the volumes bound, as I appreciate the value of the text as well as the illustrations, but to relate the illustrations in the several volumes to my books and other publications I have my own card index system, which is arranged in two groupings, general and ecclesiastical and these sub-divided practically into four main lines, personal, topical, geographical and constructional. References to text being along similar lines, but not carried out so thoroughly, except under the heading "legal," in which I have gathered all legal references, in the various publications to which I subscribe under their proper topical headings.

The "ecclesiastical" makes the greatest appeal to me, and to illustrate what is covered under "design and planning," under "personal" one firm's work is indexed beginning with Cram & Wentworth;

then, Cram, Wentworth & Goodhue; next, Cram, Goodhue & Ferguson; and at present Cram & Ferguson; and Bertram Goodhue separately, so one can find in the pages of THE AMERICAN ARCHITECT a veritable monograph of this firm's work, or of the once members of that firm.

Under "topical," arranged under abbeys, cathedrals, etc., or under Anglican, communion, Roman communion, Presbyterian, etc. Under "geographical": American, English, French, Irish, Italian and Scottish churches, each country's group alphabetically arranged.

Under general architecture: "Motifs and details," topically arranged. I have, for instance, cards for the "texture of materials," brick, rough cast plaster, thatched roofing, masonry, etc., which we usually find in what "Moviedom" calls "close-ups." To me a great deal of the charm of the Philadelphia School is the exquisite texture of the stonework, etc., and as that sense of texture of materials is not taught in the schools you will be rendering good service to the younger men by insisting that the illustrations of the work of that school shall have a "close-up," for the unforced and artistic handling of their materials lends a beauty to the work of that school which is unequalled elsewhere.

Another subject from which a monograph could be made from the pages of THE AMERICAN ARCHITECT is "rendering," which I have indexed personally under these very familiar names: Eldon Deane, D. A. Gregg, Haldane, Maginnis, and Goodhue, and so on, to the present day delightful sketches of O. R. Eggers.

I am not sure that this epistle will be of any material service to you, except to convey my appreciation for the pleasure and profit derived from THE AMERICAN ARCHITECT during these many years and to express my best wishes for the future of the publication.

Sewickley, Pa.

JAMES M. MACQUEEN.



CASS GILBERT, ARCHITECT
36th Annual Exhibition, Architectural League of New York

490'

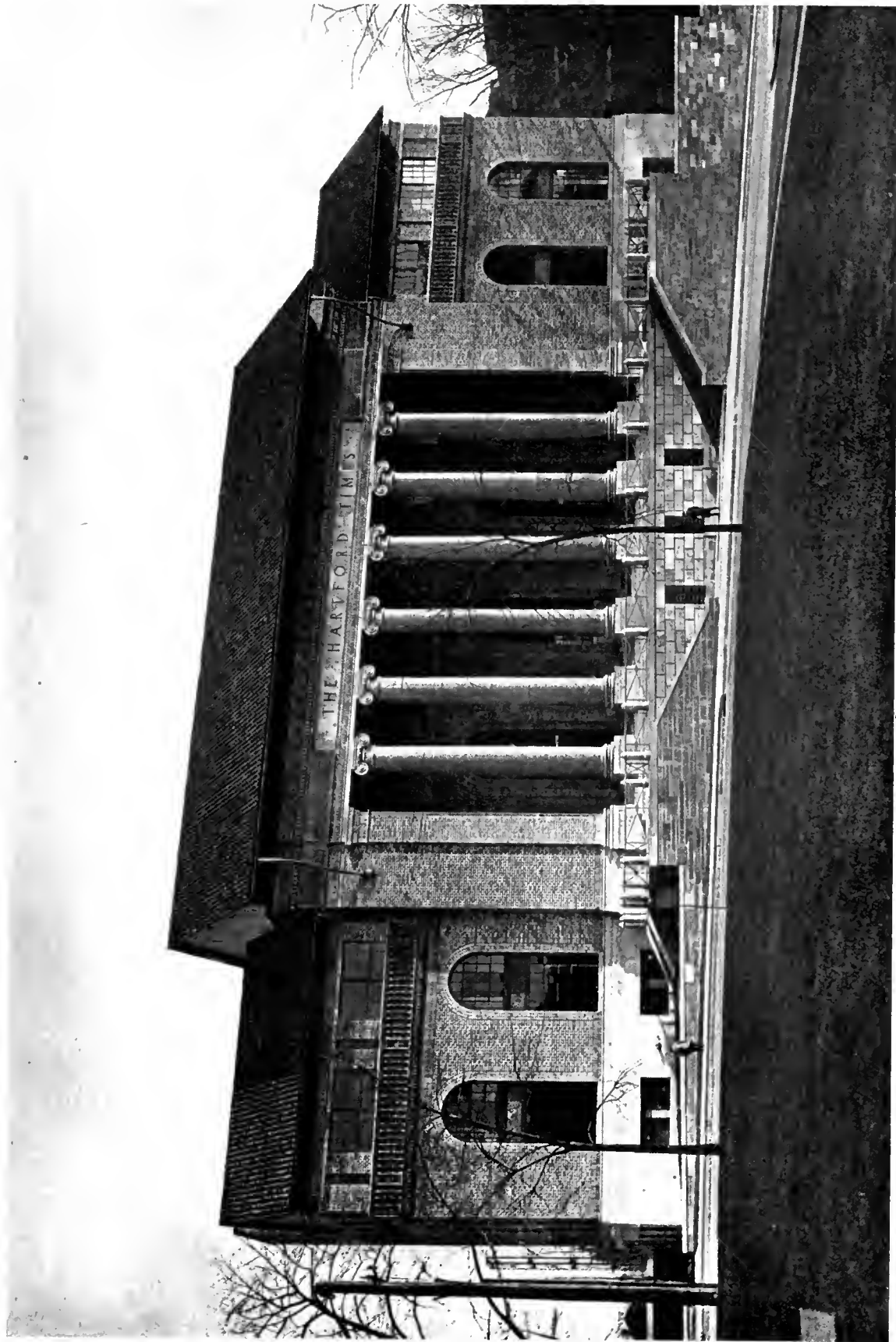

THE HARTFORD TIMES BUILDING, HARTFORD, CONN.

DONN BARBER, ARCHITECT

86th Annual Exhibition, *Architectural League of New York*

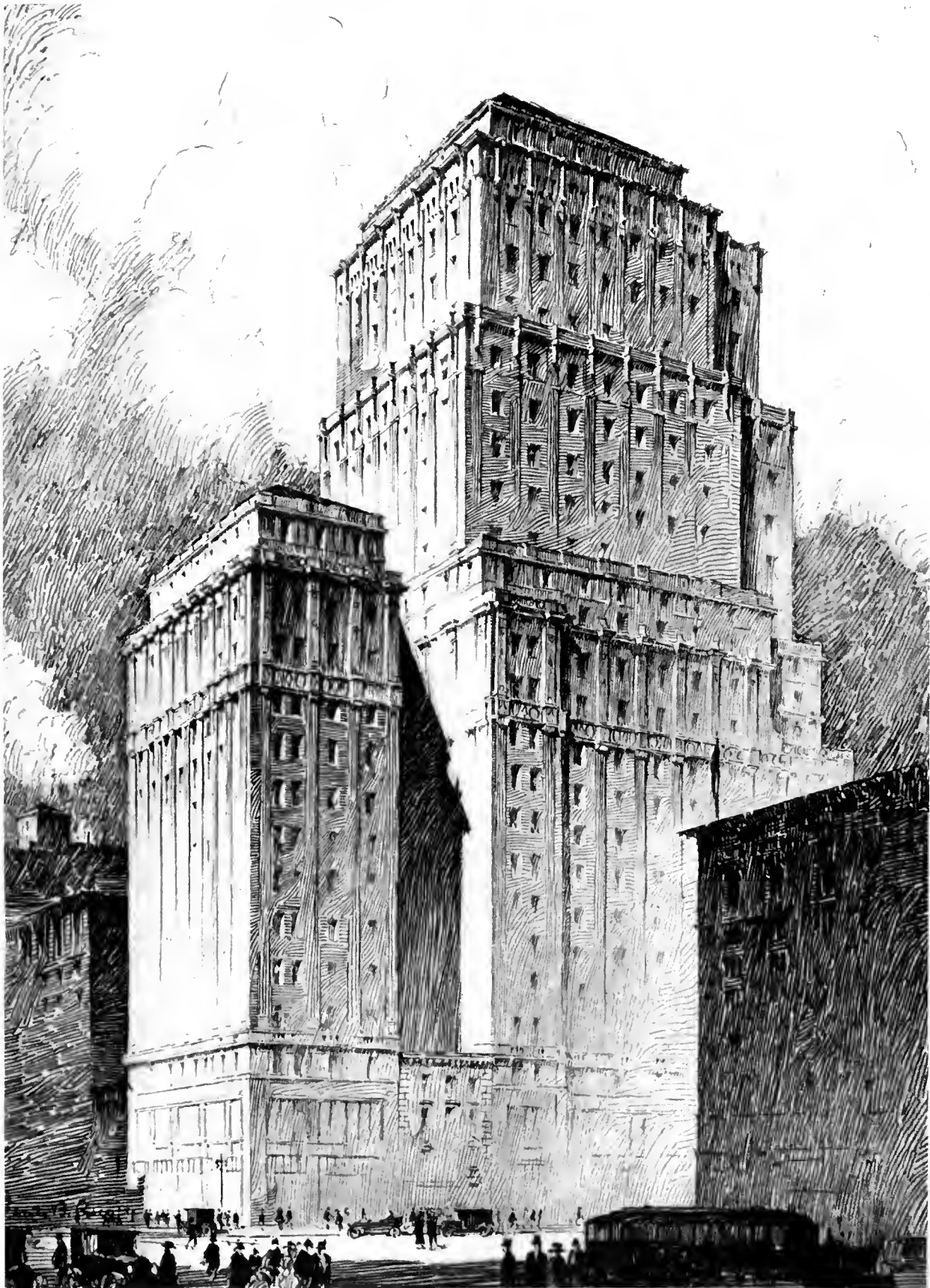

BORDEN BUILDING, NEW YORK

BUCHMAN & KAHN, ARCHITECTS

56th Annual Exhibition, Architectural League of New York

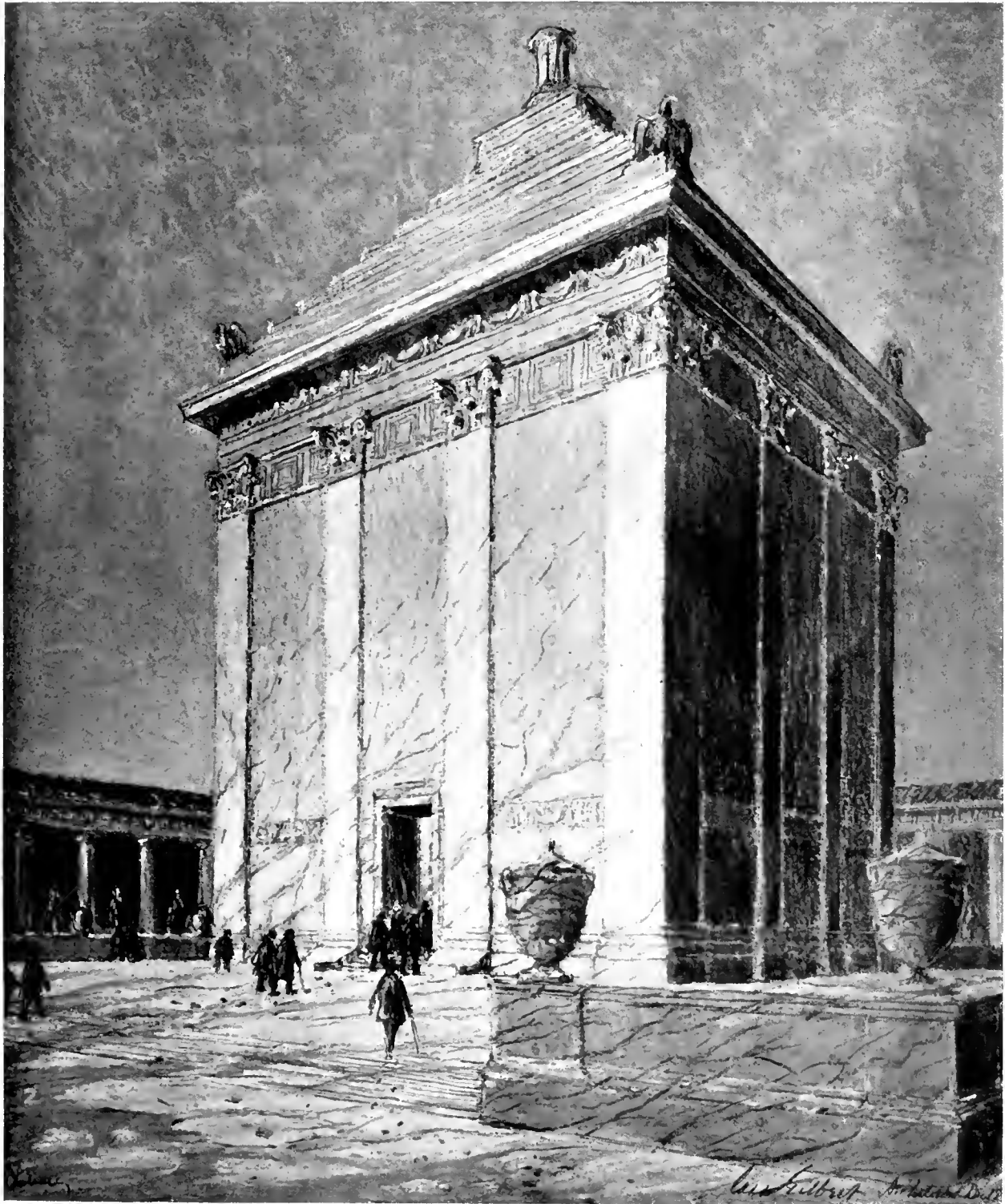

DESIGN FOR A MAUSOLEUM
CASS GILBERT, ARCHITECT

36th Annual Exhibition, Architectural League of New York



INDUSTRIAL SAVINGS BANK BUILDING, FLINT, MICH.
DAVIS, McGRATH & KIESLING, ARCHITECTS



PRIMELLES BUILDING, HAVANA, CUBA
KENNETH M. MURCHISON, ARCHITECT
36th Annual Exhibition, Architectural League of New York

496⁶



HOUSE OF MR. DUANE ARMSTRONG, GREENWICH, CONN.

JAMES C. GREEN, ARCHITECT

36th Annual Exhibition, Architectural League of New York





HOUSE OF MR. CHAPIN S. PRATT, LAWRENCE PARK, BRONXVILLE, N. Y.

BAYES & HOW, ARCHITECTS

36th Annual Exhibition, Architectural League of New York

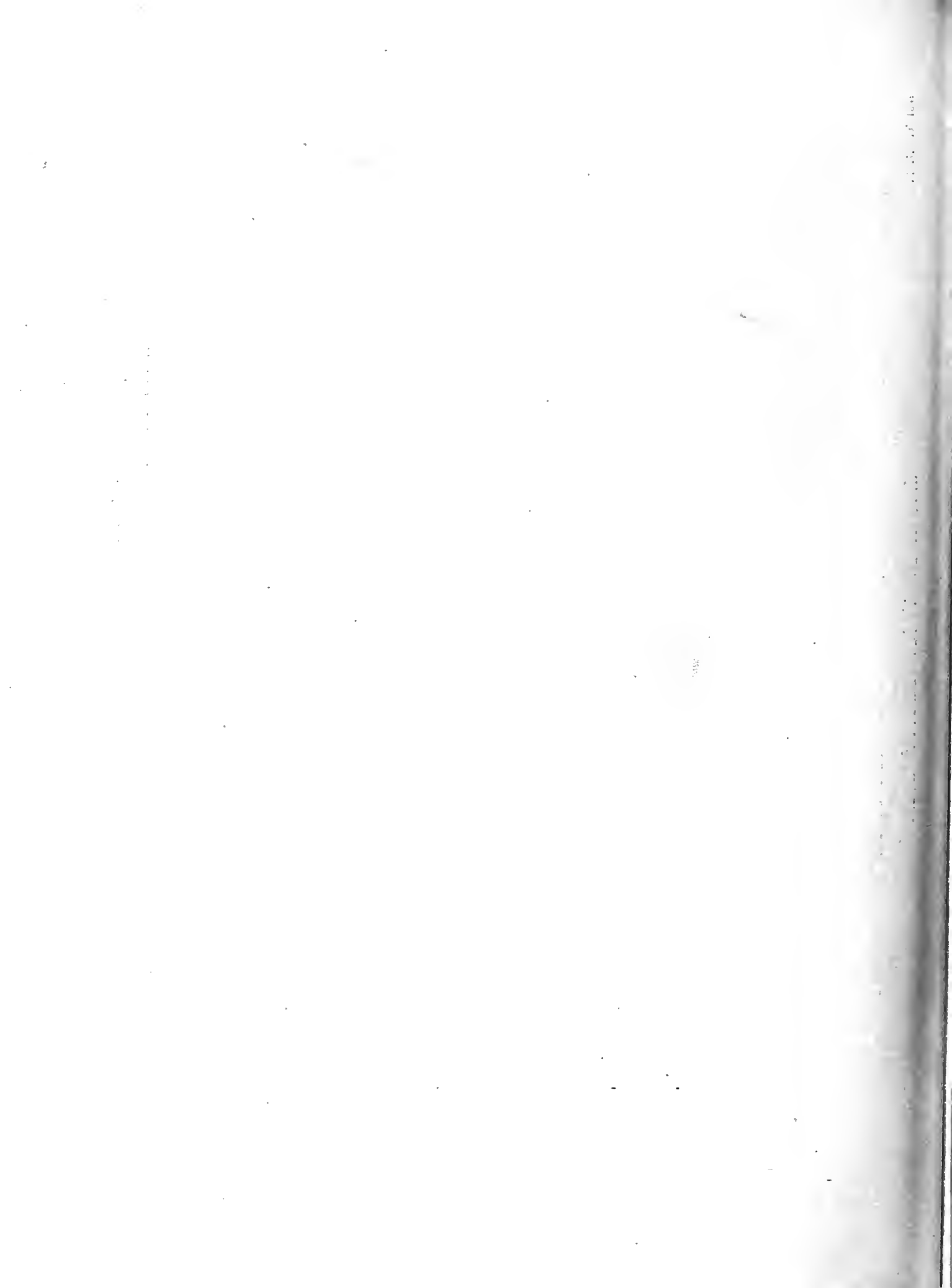

THE AMERICAN ARCHITECT



COMMUNITY BUILDING, FLINT, MICH.
DAVIS, McGRATH & KIESLING, ARCHITECTS



DOOR KNOCKER
GEORGE J. LOBER, SCULPTOR
36th Annual Exhibition, Architectural League of New York

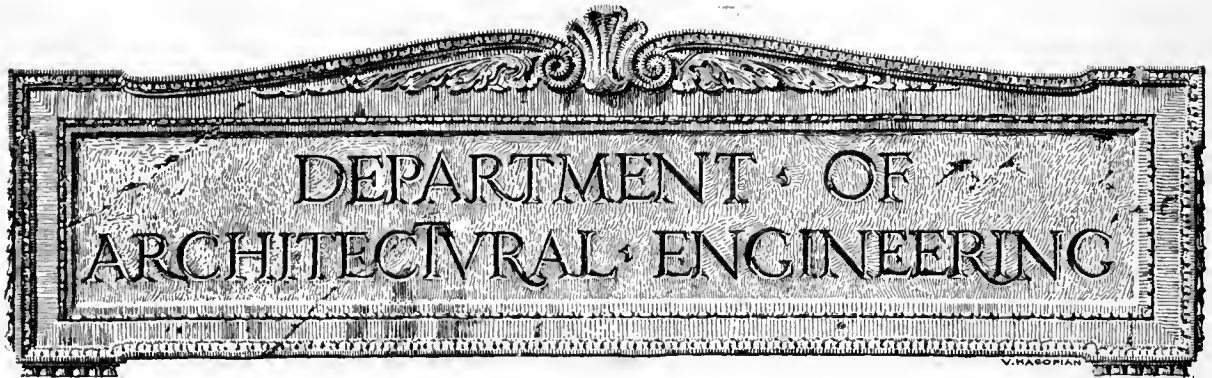

Warehouse for The National Tea Company, Chicago

JEAN B. ROHM & SON, *Architects*; L. J. MENSCH, *Engineer*

A VERY interesting feature of the office and warehouse building of the National Tea Company at Chicago is the foundations. The great improvement in the design and construction of foundations has been made possible by the use of reinforced concrete. The two things most favorable to its use are that it can be cast in any desired form and is mixed and placed by common labor. The old-time use of large footing stones and later steel grillage beams and heavy cantilever girders required the use of expensive derricks and the employment of skilled craftsmen. The materials used were of such a nature that their shape and form only could be altered at great cost. On the other hand, the forms for concrete foundations have a fairly uniform cost regardless of their shape.

At three places in this building the cantilever type of foundation was used on adjoining property lot lines. On the streets, the footings projected beyond the lot lines as is usual. In general, the cantilever footings consist of a 24 in. reinforced concrete mat. Where the more heavy column loads occur, the mat is thickened by square pads, either above or below the mat, for the purpose of affording sufficient thickness to resist the shear produced by the column loads. Such increases in thickness are shown in Sections AA, DD and EE. Attention is called to the unusual bending of the stub rods in the column bases.

Another feature of this type of footings is that the top of the mat is finished as a floor and at the basement floor level. This scheme makes a decided saving in cost over the usual methods used. The use of the foundation as a floor saves the cost of the usual 5 in. or 6 in. concrete floor with its cinder or

gravel bed. It also requires less excavation and back-filling, which is a considerable item of expense in some localities. If the soil is of such a nature that forms and shoring are required, the amount of this work is reduced also, owing to the less depth of excavation. At the time the footing at Section AA was designed the adjoining property to the south was not purchased for future extensions. This purchase was made at about the time the work was started. Rather than to re-design this footing to carry the future added load the foundation was built as designed. Provision was made for extension of the footing southward beyond the lot line by driving reinforcing bars into the adjoining earth through holes bored in the wood forms. These rods, of course, also extend into the foundation as built. When the addition is built this year, the rods will be found in place to reinforce the added foundation. The mat reinforcing is arranged similar to that of a two-way flat slab construction, which it is, in effect.

IN the driveway at Section DD, the mat is made level and below grade in order to keep these footings below the frost line, which is 4 ft. in Chicago. The elevator pits are incorporated in this type of footings, as shown in Sections AA, BB, CC and EE. The reinforcing extends under these pits similar to that in the other portions of the mat. The typical isolated footings consist of three layers of concrete, the top of the basement floor being 3 in. above the middle layer. The top layer also serves as a wheel guard for hand trucks in the basement and motor trucks in the driving-in space in the alley.

The basement walls on the streets and at the driving-in space at the alley are centered on a footing

THE AMERICAN ARCHITECT

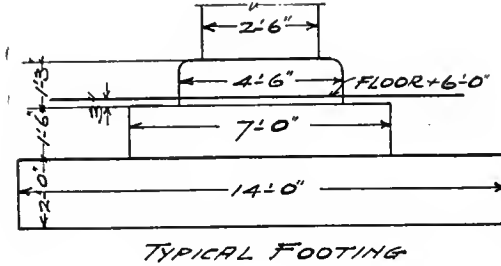
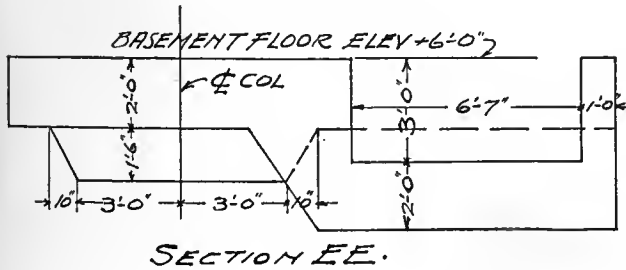
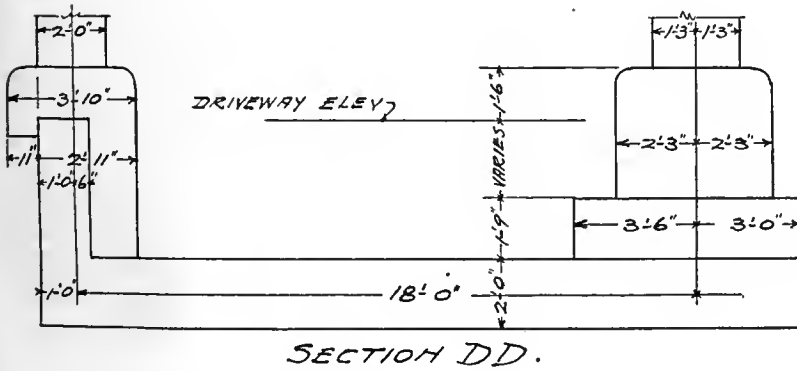
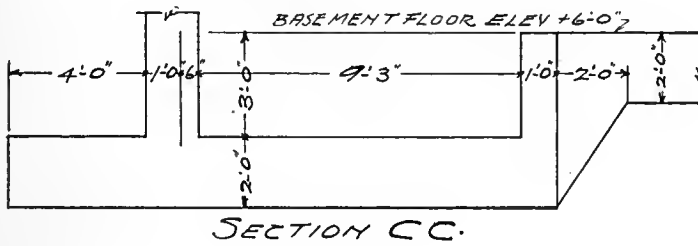
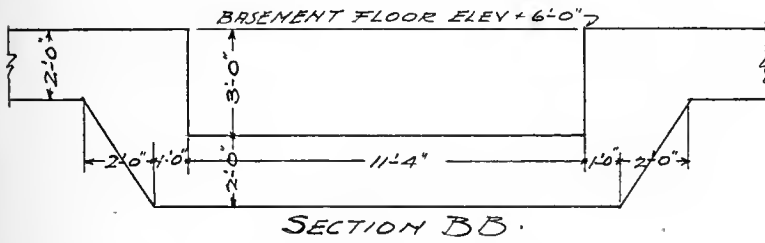
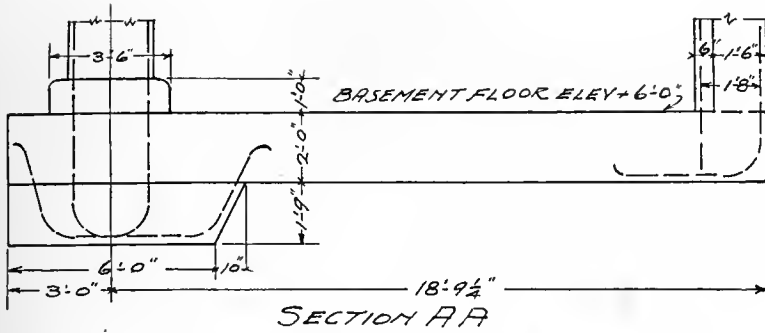

TYPES OF FOOTINGS

See preceding page for detailed descriptions

WAREHOUSE FOR NATIONAL
TEA CO., CHICAGO, ILL.

JEAN B. ROHM & SON,
ARCHITECTS

L. J. MENSCH,
ENGINEER

THE AMERICAN ARCHITECT

extending beyond the building line. This is, in effect, an inverted T-beam. This is shown in Section and Elevation FF. The wall is reinforced as a girder about 12 ft. deep and there is special reinforcing provided about the window openings as shown.

All of the floors are generally $8\frac{1}{2}$ in. thick. They are of a flat slab type with a $4\frac{1}{2}$ in. drop plate and two-way system of reinforcing. The coffee roasting department on the sixth floor is 36 ft. by 72 ft.

shown in the illustration. When the future building is erected north of the present alley, the space between the buildings will be covered by a skylight at the second floor level and a wall and doorway constructed at the street line, making an enclosed shipping court.

THE construction of this building was started September 22, 1919, and was completed, ready for use, April 15, 1920. There are over 2,000,000



WAREHOUSE OF THE NATIONAL TEA CO., CHICAGO, ILL.

in size and 18 ft. high. There are no columns in this space and the roof is supported by beams and girders; the remaining parts of the roof are of flat slab construction similar to the floors. The girders that support the north wall over the driving-in space are 36 ft. and 39 ft. long, center to center of columns. Above these, girders of the same length carry each of the upper floors and roof. This opening permits two large trucks to load in each bay and the position of the trucks is fixed by the irregular shaped curbs

cu. ft. of contents and the cost, with mechanical equipment, was \$650,000, not including the land. To this will be added two more six-story units and the present two-story portion will receive four added stories. The total contents will then exceed 5,500,000 cu. ft. The construction work was carried on during a very severe winter and concrete was placed with temperatures slightly above zero.

The floors are all designed for a live load of 250 lbs. per sq. ft. The floors were tested with a live

THE AMERICAN ARCHITECT

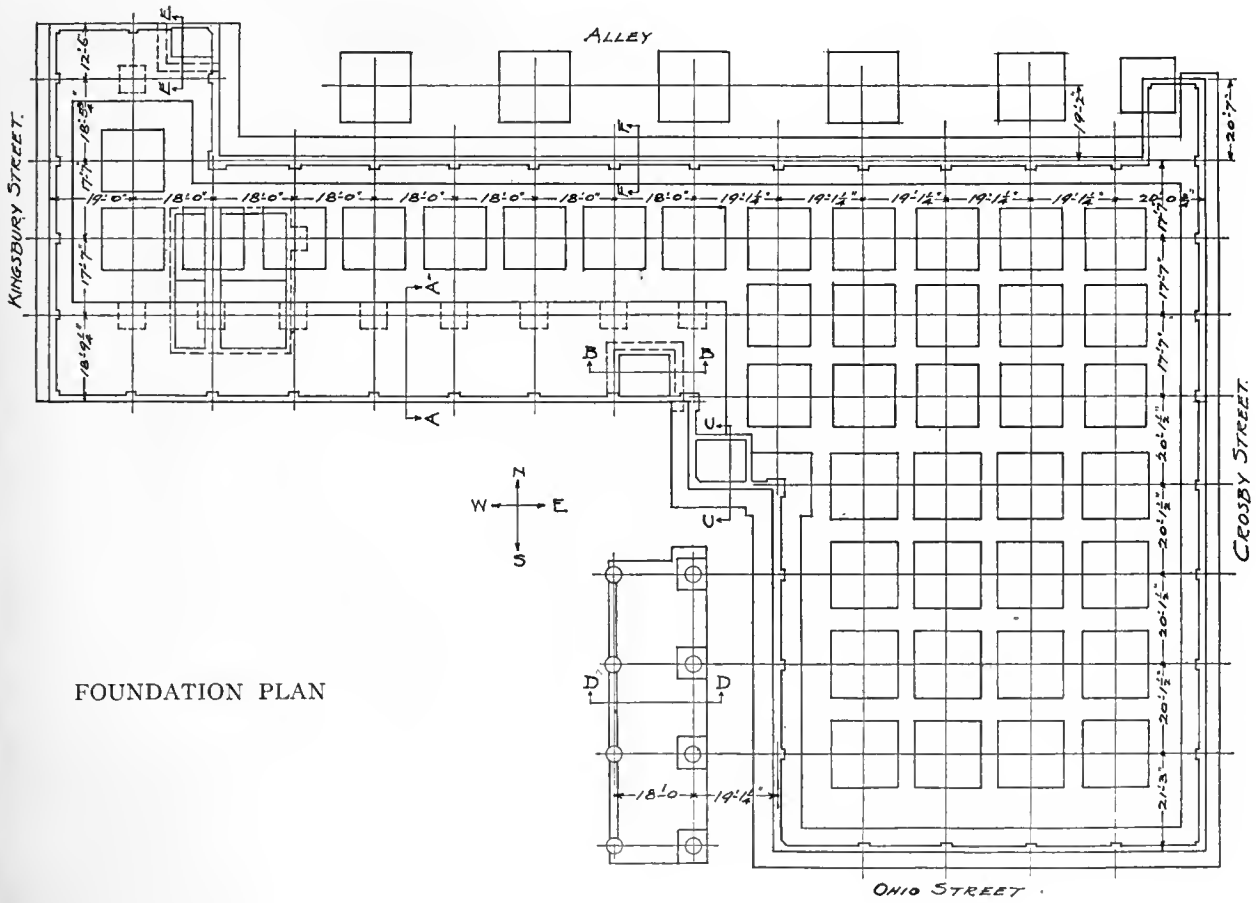

FOUNDATION PLAN

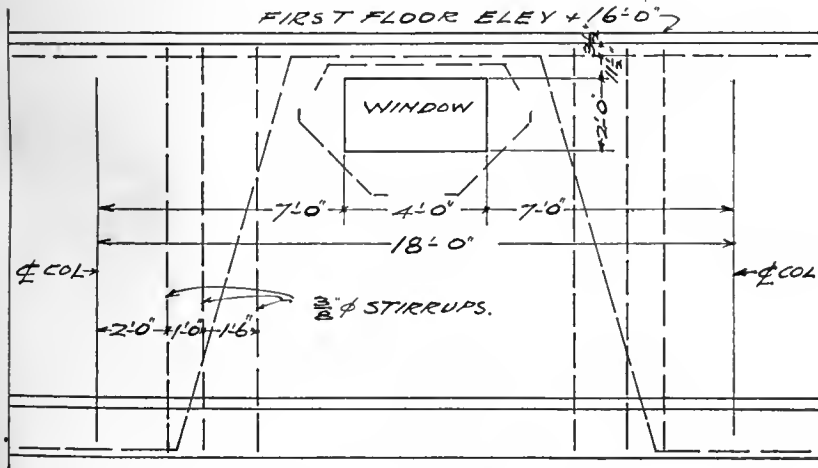

ELEVATION AT FF

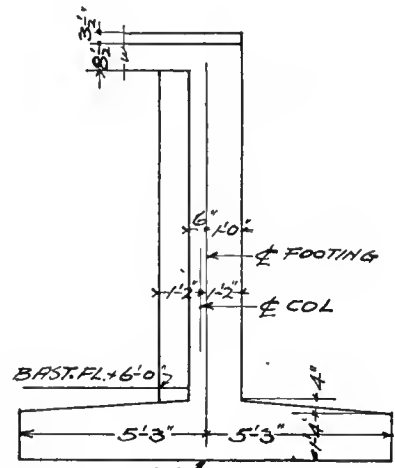

SECTION FF.

WAREHOUSE FOR NATIONAL TEA CO., CHICAGO, ILL.

JEAN B. ROHM & SON, ARCHITECTS

L. J. MENSCH, ENGINEER

THE AMERICAN ARCHITECT

load of 621 lbs. per sq. ft. with a deflection of 3/16 in. at center of the panel. The foundations were designed for a ground load of 4,000 lbs. per sq. ft. After the work was started, the owners decided on some changes in the second story which increased certain column loads. As the material was fabricated and ready for use cast iron "Emperger" columns were placed inside the spirals to carry the added loads.

The basement is used for general storage and has cooler rooms for butter and cheese, which, with the dried fruit cooler rooms on the third floor, are kept at a temperature of 35 degrees by a 15-ton refrigeration plant. The first floor is used exclusively for receiving and shipping and is elevated to the level of the freight cars which are placed on the Kingsbury Street side. About 10,000 sq. ft. on the second floor are devoted to offices, the balance to an egg candling department, kitchen and lunch rooms, large package department and a bakery with a present capacity of 10,000 loaves of bread per day. The third floor con-

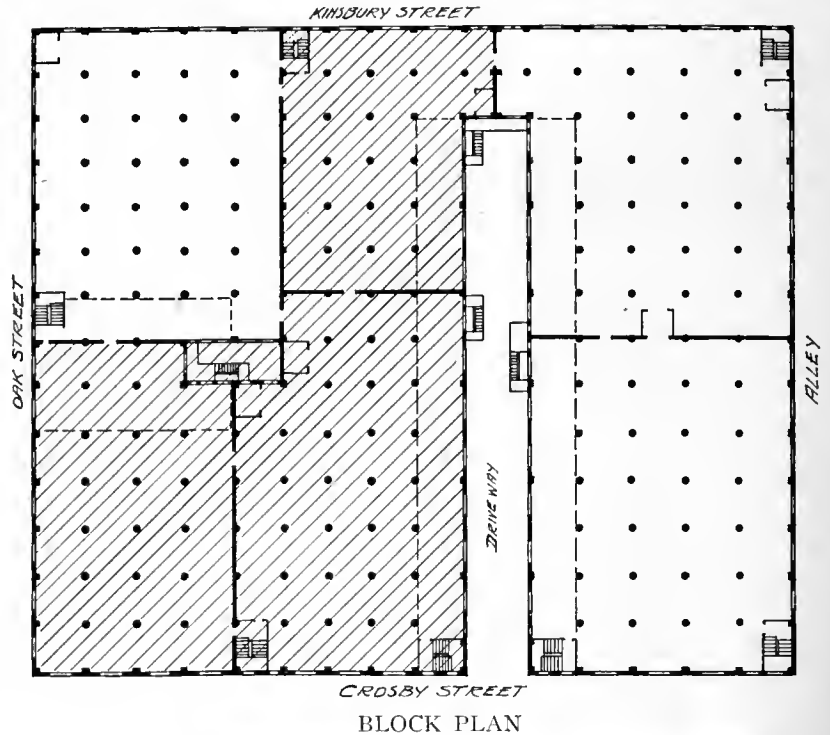

BLOCK PLAN



DRIVEWAY

tains the dried fruit cooling rooms and the extract and pickling departments. The fourth, fifth and sixth floors are used for general storage, with the coffee roasting department on the sixth floor. The first and second floors have 1 1/8 in. maple top floors laid on 3 by 4 in. beveled sleepers bedded in cinder concrete; the sleepers were attached to the concrete floors by heavy spikes when the slabs were still



VIEW OF GENERAL OFFICES LOCATED ON SECOND FLOOR

green. The balance of the floors are finished with cement. The driveways are made with a 10 in. con-



VIEW IN COFFEE-ROASTING ROOM ON SIXTH FLOOR



VIEW IN BAKERY DEPARTMENT ON
SECOND FLOOR

crete base, reinforced two ways with $\frac{1}{2}$ in. rods placed 24 in. on centers. The topping is of asphalt 2 in. thick on a $1\frac{1}{2}$ in. binder course.

The building is equipped with three electric high speed elevators of 7,500 lbs. capacity, two 8 ft. spiral package chutes, opening to all floors above the first, a vacuum system of steam heating and a two source combination wet and dry sprinkler system. The capacity of the building is such that ten carloads of merchandise are received daily, a total of 225 tons of foodstuffs is received and distributed each 24 hours, and the distribution to the 200 retail stores operated by the company is made by a fleet of 50 gasoline and electric motor trucks.

A House For \$3,000

A New York corporation is negotiating for the erection of fifty six-room houses to be erected on Staten Island at a cost of about \$3,000 each. The Housing Commission of Newark, N. J., is also considering the erection of a number of similar buildings to meet the housing demand.

A number of these houses have been erected at Phillipsburg, N. J. The houses are monoliths and are poured in forms. After the cellar excavation is completed, concrete footings and the concrete floor for the basement are poured.

On this base the forms are erected. As the form is fitted, electric light conduits, plumbing, roughing, chimney flue linings, window frames and door frames are set in position.

The reinforcing is placed for walls, floors and par-

titions and the concrete is then poured. The pouring is done by raising the concrete to a hopper on the roof of the building.

The concrete flows from this point through the walls and partitions from the base (already made) to the roof, at one pouring.

After the concrete has set and the forms have been removed one sees a building having its window and door frames embedded in concrete and finished; the chimney completed and the concrete floors, concrete stairway leading from the kitchen to the basement and concrete front steps and porch all there.

It requires eight hours to pour a four-room house and from eight to eleven hours to pour a six-room house after the forms are erected. The erection of forms to the pouring stage requires four days; one house per week being erected and poured with one form under normal working conditions and permitting time for the concrete to set before the forms are removed. It requires a crew of ten to twelve men and one working foreman to do this.

Book Note

"RED LEAD, AND HOW TO USE IT IN PAINT." By Alvah Horton Sabin, M. S. D. Sc. Third edition, revised and enlarged. Full cloth, 140 pp., size 5 x 7 $\frac{1}{2}$. New York, John Wiley & Sons, Inc. London, Chapman & Hall, Ltd.

The use of red lead as a preservative of metal surfaces is so general that the annual consumption has become enormous. The correct methods of application are, however, not so extensive. In many cases red lead is so ignorantly used as to negative the result desired. A book of this nature, therefore, becomes a valuable guide in the mixing of preservative compounds for application to metal surfaces. The success that attended an earlier edition gave proof of the fact that such a book was widely needed. The new and revised edition brings the subject of red lead up to an authoritative point. It will be a valuable addition to the working library of architects and engineers.

Relative Strength of Sheathing and Wall Board

A PRACTICAL TEST to determine the relative strength of sheathing and Bishopric Board as applied to construction was recently made by the department of building inspection at Hartford, Conn. A load of 300 pounds was used, deformation being measured at each loading.

The result of the test on $\frac{7}{8}$ " M and B sheathing, one side, with wood lath on opposite side, was as follows:

300 deformation	$7/32$ "	1200 deformation	$2\frac{3}{4}$ "
600	" $21/32$ "	1800	" $6\frac{7}{16}$ "
900	" $1\frac{1}{2}$ "	2100	" $8\frac{5}{16}$ "

When load was released deformation showed $5\frac{3}{16}$ ".

Result of test on Bishopric Board on one side, with wood lath on opposite side using same loading as on sheathing showed the following deformation:

300 deformation	$1/8$ "	1500 deformation	$1\frac{3}{4}$ "
600	" $1/4$ "	1800	" $1\frac{9}{16}$ "
900	" $9/16$ "	2100	" 2 "
1200	" $13/16$ "	2400	" $2\frac{7}{16}$ "
		2700	" $3\frac{1}{16}$ "

When the load was released deformation showed $15\frac{1}{8}$ ".

In his report to the Bishopric Mfg. Co., Frederick W. Barrett, supervisor of buildings, stated that the test showed very clearly that Bishopric Board properly put on was much stronger than sheathing, and that there was no reason why same should not be allowed to be used where $\frac{7}{8}$ " sheathing can be used.

Fire Tests

THE ASSOCIATED FACTORY Mutual Fire Insurance Companies, the National Board of Fire Underwriters, and the Bureau of Standards, Department of Commerce, Washington, D. C., have conducted jointly an experimental investigation of the resistance of columns, loaded and exposed to fire or to fire and water. The purpose of the investigation was to ascertain (1) the ultimate resistance against fire of protected and unprotected columns as used in the interior of buildings; (2) their resistance against impact and sudden cooling from hose streams when in a highly-heated state. The fire test series includes (1) tests and representative types of unprotected structural steel, cast iron, concrete-filled pipe, and timber columns; (2) tests wherein the metal was partly protected by filling the re-entrant portions or interior of columns with concrete; (3) tests wherein

the load-carrying elements of the columns were protected by a 2-in. or 4-in. thickness of concrete, hollow clay tile, clay brick, gypsum block, and also single or double layer of metal lath and plaster; (4) reinforced concrete columns with 2-in. integral concrete protection. Copies of this 389-page report may be had upon payment of \$2 to the Associated Factory Mutual Fire Insurance Companies, 31 Milk St., Boston, Mass., or to the Underwriters' Laboratories, 207 East Ohio St., Chicago, Ill.

Protection for Reinforced Concrete Against Electrolysis

A WATERPROOF SHELL protecting the concrete structure is the most plausible form of protection of reinforced concrete against electrolysis because the arrangement not only protects the reinforcing bars from moisture and later oxidation but also protects the concrete surrounding the rods from abrasion and, eventually, exposure of the iron. Last year it was suggested that the following methods be considered: (1) Use of copper plated reinforcing bars; (2) Introduction of reinforcing bars made of copper alloy; (3) Reinforcing bars surrounded by rough insulating enamel impervious to salt water and moisture; (4) Waterproof plastic layer of material with petroleum asphalt base, or some established waterproofing material free from electrolytes, surrounding base of concrete.

Further studies have led to the conclusion that the first three methods proposed are not practical because of high cost.

The fourth method is recommended, but attention is called to the necessity of using the proper waterproofing material on the inside of the protecting shell. The waterproofing pitch should remain flexible for an indefinite time; should have a melting point in the neighborhood of 200 deg. F., and be elastic in stretch at least $\frac{1}{2}$ in. at a temperature below freezing and have approximately an inch stretch at 60 deg. F. If the pull is gradually applied, the stretch should be approximately 6 to 7 in. at 60 deg. It is rather a surprising fact that such waterproofing material has been manufactured for twelve or fifteen years, but in general use only for roofing material and in pavements. It is made by distillation of an asphalt base and oxidized by blowing with air, the latter process giving the material the stretching quality.

Asphaltic petroleum pitch is soluble in gasoline, which is likely to be present in city sewerage, but recent experiments show an elastic waterproofing pitch may be made from coal tar that is insoluble in gasoline but retains all of the characteristics of the asphaltic petroleum pitch.

Current News

Happenings and Comments in the Field of Architecture and the Allied Arts

Philadelphia Architects Receive Gold Medal Award

Paul P. Cret and Zantzinger, Borie & Medary, associated architects in the designing of the Public Library, Indianapolis, Ind., have been awarded the gold medal in the architectural exhibition conducted in Philadelphia in connection with the Real Estate and Housing Exposition. This architectural exhibition was in fact the usual annual exhibition of the T Square Club and the Philadelphia Chapter of the American Institute of Architects. This year the annual exhibition of these architectural organizations was, in a movement for co-operation, combined with the Real Estate and Housing interests, whose exhibition has but recently been brought to a successful close.

Jamestown Architects Organize

C. O. Hultgren, of Rulifson & Hultgren, Is a Member of Executive Committee

Architects and engineers of Jamestown, N. Y., have organized the Jamestown Engineering Society. Meetings are held on the first and third Wednesdays of each month except July and August.

Officers have been elected for the coming year as follows: President, Walter F. Shaw, Assoc. M. Am. Soc. C. E.; Vice-President, E. C. Dollard, City Engineer; Secretary, H. Grover Garlock, Chief, Contract Department, Dahlstrom Metallic Door Co.; Treasurer, F. A. Irvine, former City Engineer.

C. O. Hultgren, of the architectural firm of Rulifson & Hultgren, is a member of the executive committee, and J. W. Rulifson is a member of the program committee.

Doctors' Co-operative Building

A new professional building for doctors and dentists, to be owned under the co-operative plan, is to be erected at 141 East Sixty-fourth Street, in New York, with an "L" to Lexington Avenue.

Herbert Lippmann, architect, prepared the plans for the project, which has several interesting features. A special entrance from East Sixty-fourth Street of Italian garden design, built of brick and stucco, with a varicolored slate roof, has been designed, and will provide parking space for automobiles. It will lead directly into a large reception

room, and to the quarters of the resident nurse in charge.

The building proper, which will have frontages of 50 feet on the private court and on Lexington Avenue, will thus have excellent light and air. It will be five stories and basement, occupying an area of 2,500 square feet. A large elevator and fireproof stairway will be located in the centre of the building, and while the floors will be arranged to suit the individual requirements of the groups of doctors, the typical floor has been laid out with a large waiting room for joint usage and five suites of offices. Each suite consists of a private office, treatment room and dressing room.

Building operations were proposed to have started April 1. The offices will be ready for occupancy before October 1, 1921.

\$600,000 in Leases

The demand for space in the Pennsylvania Station zone in New York is shown by the fact that the renting agents have closed forty leases in the twenty-two story Printing Crafts Building covering the block front in Eighth Avenue between Thirty-third and Thirty-fourth Streets since Jan. 1.

This is considered a record for the number of leases in any building in the City of New York during the same period, especially when it is borne in mind that these leases were negotiated at a time when business generally was at its lowest ebb.

These forty firms came from every industry and nearly every section of the city. The leases made aggregate about \$600,000 a year.

To Push Home Building by Advertising Campaign

A national newspaper advertising campaign to stimulate home building is to be undertaken by the lumbermen of the country after the third American Lumber Congress, held in Chicago from March 30 to April 1, the National Lumber Manufacturers' Association announced recently. Plans for the campaign have been worked out by a committee of the association for presentation to the Chicago meeting for action.

According to the association, 50 per cent. of the sawmill capacity of the country is now idle because of a lack of demand for lumber.

Artists Divide Auto Prize

Three well-known artists, James Cody Ewell, Jonas Lie and Maxfield Parrish, will divide the \$1,000 prize for the best painting portraying "The Spirit of Transportation." The announcement was made last week at the Detroit Athletic Club, where the paintings are on exhibition by Eugene B. Clarke, President of the Clarke Equipment Company, who arranged the contest as a tribute to the automotive industry.

The jury of award consisted of Judge Elbert E. Gary, Chairman, United States Steel Corporation; Robert W. de Forest, President, Metropolitan Museum of Art; Charles L. Hutchinson, President, Art Institute of Chicago; W. C. Durant, President, Durant Motors Corporation; Homer L. Ferguson, President, Newport News Shipbuilding and Dry Dock Company, and Frederick D. Underwood, President of the Erie Railroad Company.

Bill to Register Builders in New York City

A bill just introduced in both houses of the New York State Legislature provides for registering builders in New York City, and prohibits the issuance of building permits to or the conduct of building work by any persons not duly registered. The purpose is to be accomplished by amending the charter of the city by the addition of a registration clause. Under this clause a building permit can be issued only to an architect, engineer, builder, contractor or other person duly registered in the office of the Bureau of Buildings as a person fully qualified to undertake or supervise the work of construction or alteration covered by the permit.

Concerning the method of registration, the bill provides that the superintendent of buildings shall, within ten days after an application for registration, issue to the applicant a certificate of registration or furnish him a statement in writing setting forth the reasons for rejection.

Certificates of registration may, however, be issued to anyone who has received a permit for building work within the past three years and has not since been convicted of violation of a building regulation. The superintendent of buildings has power to cancel any certificate of registration for cause.

This bill was presented at the instance of the building authorities of New York City. According to Rudolph P. Miller, superintendent of buildings, Borough of Manhattan, its object is to place more definitely the responsibility for proper and safe construction and compliance with the building law. It is supported by a resolution of the Building Officials' Conference, advocating that building

operations be restricted to persons of proved ability.

Experience in the Borough of Manhattan, Mr. Miller states, has demonstrated the need for a law to fix responsibility on builders. "It has not been unusual for an applicant to submit to this bureau for approval a set of plans and then to pass on to the builder or owner a different set with the misleading information that they are approved; to work contrary to approved plans; to work without a permit; to make misstatements or misrepresentations in the application or on the plans as to surrounding conditions that vitally affect the validity of the permit; and to change the occupancy of a building after its completion contrary to the certificate of occupancy."

Builders Form New Organization

Prominent Men Perfect Chicago Expert Builders—
William M. Lawton Made President

An organization to be known as Chicago Expert Builders has been perfected in Chicago, the membership to include architects, engineers, contractors, building material men, real estate men, bankers and lawyers, who are necessary for either the building, purchase sale or financing of building operations. The slogan of the association is "Build Chicago Better," this being one of the purposes of the new organization.

An application for charter has been sent to the state capital at Springfield, Ill. The following objects of the incorporation were contained in the certificate:

1. To "build Chicago better."
2. To further and promote proper civic ideals for great public works and undertakings and to aid and assist in the planning, development and building of the same; to teach and develop scientific methods in municipal works and to encourage efficiency in public affairs.
3. To provide expert advice and to furnish practical, efficient and intelligent solutions for building, construction and engineering problems affecting the location, permanent well being or existence of all industries.
4. To promote co-operation between its members and to render mutual assistance in all their undertakings.

The officers selected include the following: President, William M. Lawton, former attorney for the Cook County Real Estate Board and now attorney for the Real Estate Association of Illinois; first vice-president, Robert Isham Randolph, head of the firm of Isham Randolph & Co., and president of the Chicago Chapter of American Association Engineers, and vice-president of the Illinois Society

THE AMERICAN ARCHITECT

of Engineers; second vice-president, Frank D. Chase, president of Frank D. Chase, Inc.; secretary, Ivan O. Ackley, of Ackley Brothers, real estate. All of the officers are located in Chicago. Temporary offices have been opened in the First National Bank building, that city, and permanent quarters will soon be established.

In discussing the new association, Mr. Lawton said that they had organized for the purpose of doing their part in bringing about a better building situation in that city and to take advantage of the new zoning law which will probably be passed July 1. He also stated that although the Chicago Expert Builders did not propose to interfere with the work of the Chicago Plan Commission or the local real estate boards, it did intend to carry out plans for private as well as public buildings on a scale that would be impossible for any building organization of limited capital to undertake.

Favors State Financing for Home Building

Mr. E. Osborne Smith, a New York real estate man, advocates a state plan for providing funds for home building.

"Homes must be built and built at once," said Mr. Smith. "The laws passed by the Legislature this year did nothing to encourage building, and the law exempting new buildings from taxation, which was devised to encourage building, has done nothing in providing homes.

"If an emergency exists, and if the state can exempt buildings from taxation, it can provide a fund whereby the state would guarantee lending institutions money invested on first mortgages, which first mortgages should be liberal building and permanent loans having a long period to run, and to be amortized at a high rate for the first five years, while building costs and rents are high, and decrease thereafter.

"Only the rich builder can build today, as loans made for new buildings are not liberal enough. There is too large a margin between the present cost of building and the amount of loans offered for any-

body but a rich builder to undertake to build. Give the builder with limited capital a chance and you will soon see a change in the housing problem.

"The idea is to get the small builder building again, which he cannot do under the inadequate loans offered by institutions at the present time. Make the mortgage liberal, and let the state guarantee or underwrite the mortgage under proper safeguards. This can be done without loss to the state, and it will start a new building boom."

Personals

J. H. Hetherington, architect, has moved his office from Room 751, 140 South Dearborn Street, Chicago, to Room 110, that same address.

Herbert E. Erickson, architect, has moved from 515 Broadway, Gary, Ind., to 34 West Fifth Avenue, that city. Mr. Erickson desires new catalogues and samples.

Kauzor Bros., architects, Dollar Savings & Trust Building, N. S., Pittsburgh, Pa., announce that this is their correct address and not Renshaw Building, where mail is frequently addressed to them.

C. Howard Crane of Detroit, Michigan, announces the opening of a New York office, at No. 562 Fifth Avenue, under the direction of Mr. E. M. Milnar, formerly with Thos. W. Lamb, of New York City. Samples and catalogues requested.

Stuart H. Edmonds, architect, is the name under which the architectural firm of Edmonds & Richards was operating at 32 Rouss Avenue, Winchester, Va. This partnership has dissolved, and Mr. Edmonds is located at 45 West Water Street, that city.

Eugene Waggaman, formerly connected with Clarke Waggaman, is now practising architecture with Harry Wardman, the Washington apartment house specialist and builder, under the firm name of Wardman & Waggaman, with offices at 1430 K Street, N. W., Washington, D. C. Catalogues and samples are requested.

International Situation

TWO things about Europe must be firmly fixed in the average American's mind before we can see any substantial improvement in the international situation.

Here are those facts:

1. There are a number of countries (and the United States is one of them) whose raw material markets are dependent, to a small or great degree, upon the European market.

2. Long-term credits for Europe must become second nature to American business men who intend to do any business whatsoever with Europe.

Now, these seem to be simple facts, and yet they are, curiously enough, rather vague and far-fetched things to not only the average, but to the keen-minded American.

The first is too obvious to necessitate elaboration. The second is very little understood by even American exporters, simply because they know practically nothing of European psychology.

The National Bank of Commerce in New York recently wrote us the following on this point:

"It is important in connection with the European situation that the effect of the establishment of an export business on a long-time credit basis should not be misunderstood. In the face of the present shortage of capital the sale of raw materials on any other terms than cash or an exchange of commodities does not alter the immediate situation. The sole result is the substitution of one kind of obligation for another. In other words, it will require years to make up not only the actual capital destruction which resulted from the war, but also the loss in capital accumulation and the disorganization of productive activity which resulted from it. American business should frankly recognize this condition. A reasonable export business can be done with due regard to established credit standards, and business on any other basis is undesirable. There is neither formula nor legerdemain by which poor credits become good, nor means whereby large business can be done with those whose credit does not permit or warrant such transactions."

Cabinet May Urge Wage Reductions

PRESIDENT HARDING'S Cabinet is considering the disturbing economic situation in the country, and giving particular attention to a full discussion of the railroad situation.

It is significant and encouraging that, according to press reports, the Cabinet went into detailed discussion of the railroad situation particularly. President Harding called the Chairmen of the Interstate

Commerce Commission and the United States Rail Labor Board into conference on the problem of a contemplated 10 per cent. reduction in wages, and the Senate Committee on Interstate Commerce is enlisted with President Harding in an effort to solve the transportation difficulties by a proposed revision of the Transportation Act.

All this speaks well for the immediate future, as a definite program will probably be worked out before the present extra session of Congress, during which the legislative part of the program will be submitted for action with a plea for speed.

The important part of this program will be the contemplated 10 per cent. reduction of wages. This will give the railroads \$360,000,000 annually. The annual deficit of the railroads at present being a trifle more than \$700,000,000, there will be left about \$340,000,000 to wipe off in the deficit, and this, it is expected, will be effected by reductions in the prices of the three most important items in railroad operations: lumber, coal and steel. Lumber is already cheaper. The coal bill will probably be reduced this year \$100,000,000. Steel will become cheaper if wages are reduced—so the steel men say.

Transportation is given prominence in any discussion of the economic situation because it is the biggest factor exclusive of labor, in costs of any manufactured article or raw product which requires shipment. It is argued, and argued correctly, that a reduction in wages will effect a reduction in working costs, and that this may be passed on to the consumer—the ultimate consumer—in a lowered cost for the product. This is sound economics. An article worth \$10 today represents a rough average of 60 per cent. for labor and 40 per cent. for the materials, overhead, etc. If it is generally known that a 10 per cent. reduction in wages has been effected, it would be impossible for a corporation or manufacturer to continue charging the same price for the article. Public opinion, adequately backed by proper publicity, would prevent such a thing.

Fundamentally, the whole problem must be met by one of two alternatives. Either the costs of living must be reduced first, or labor must be reduced. The first is too long and difficult a process. It is much more effective and feasible to reduce labor costs first. And it follows naturally that living costs would follow in short order, because the nation-wide excuse for exaggerated and excessive costs of food-stuffs and materials today is always "labor" and with that excuse removed, the manufacturer and the corporation will be forced (if they do not desire to do so now) to reduce the cost of the product to the ultimate consumer.

Take away the excuse for high costs, and there could be no possibility of their continuance.

Weekly Review of the Construction Field

With Reports of Special Correspondents in Regional Centers

PRESS reports throughout the entire country indicate that disputes in the matter of wage agreements are seriously retarding the resumption of the already too long delayed building activity. Notably is this true in Chicago where a proposition on the part of the builders to cut wages 25 per cent. has been discussed with considerable animation, and no definite conclusion has been reached.

A committee, appointed by the Boston Chamber of Commerce, to investigate conditions in the construction industry, has made its report. This is an interesting and very valuable document, and is probably the most remarkable of its kind that has been presented during the reconstruction period. Emphasis is laid on the fact that many of the grievances which building contractors hold against the labor unions were actually written into the working agreements by and with the consent of contractor and builder organizations. The committee reaches the conclusion that for the union restrictions on output and working conditions, responsibility may be equally divided between organized labor and the contracting organizations which signed the agreements into which these restrictive provisions were incorporated.

The Federal Reserve Board's review of general conditions during March shows little change from that noted for the preceding month. All the uncertainties, present and past, have continued during March, and, according to the report, there has not been a great progress made towards normal conditions. Certain industries that logically at this time of the year show increased activity have been busy. This activity is merely a seasonal one and does not indicate any pronounced advance over the preceding month. Consumption on the part of the public at large, in spite of the fact that employment is at a lower level than heretofore, continues strong. The reduction noted in wholesale prices is about 6 per cent. for the month of February, and a continuation of this reduction for the month of March is set down at approximately the same rate.

Unfortunately, it is not possible to report any pronounced movement towards a resumption of home building. The shortage continues to be acute, and the lack of proper housing and the present high rentals are working very serious hardships. In view of this housing shortage, and with reference to the enormous fire loss reported for January and February, it would seem that any loss or damage to dwellings of any kind, brought about through carelessness, should be summarily dealt with. The fire

loss in the United States, any way that it may be viewed, is unnecessarily large. It does not seem possible in this country to reduce it to the same comparatively low percentages that maintain in Europe. As the fire loss in the United States is so out of proportion, and as the housing shortage is so serious, it is worse than criminal to fail to take necessary steps to penalize in the strongest way any carelessness that will reduce housing accommodations.

Bring Living Costs Down First

Labor Leader Points to Injustice of Demands to "Bring Down Labor Costs"—The Two Big Questions of the Day

A labor leader some time ago made this answer to a proposal that wages be reduced about 18 per cent in certain industries:

"If you gentlemen who are proposing this cut in wages will see to it that the costs of living are brought down 18 per cent., we will then discuss a similar cut in wages."

Now, THE AMERICAN ARCHITECT is in no sense a spokesman for organized labor, but it does realize that this labor leader said something which has apparently not been grasped by a vast number of people in the United States.

There are two problems in the building industry today, as there are two problems in almost every industry of the United States. Those problems are wages and materials. The latter depends upon the former. And the former is—or should be—regulated by living costs.

As long as living costs remain where they are, there will be little hope of effecting either a satisfactory or an effective cut in the wages of labor.

And what is the chief item in holding living costs to their present levels? Rents. There one finds the keynote to present living costs. Clothing, food and other factors in living costs play their part, but none of them can be compared to rents in the sum total of those costs.

The big item is rents. All sorts of estimates have been made as to just what share of expenditures rents constitute at this time. Regardless of any imposing array of estimates or figures, plain common sense alone will furnish sufficient and conclusive evidence as to their unwarranted proportion in any budget. Rents are too high—far too high. That is the simple truth of the matter.

Bring them down enough to justify an adequate cut in that greatest factor in living expenses, and

you will then have a basis upon which to base suggestions for the reduction of wages. But it is not at all fair to talk of reducing wages without a corresponding reduction in rents, or in other factors in living costs.

So far as the construction industry is concerned, another factor must also be looked after. There must be availability of money, at 6 per cent. And by availability this journal does not mean that sort of availability which calls for "premiums" and other practices of the financial group. Simple, straightforward lending of money at 6 per cent., a willingness to lend it when asked for, and an adequate enough supply to meet all expected demands are what constitutes real availability. These are the big problems of the day. It is time to turn our attention to those persons still demanding unreasonable rents, and to the financial group which somehow makes it difficult to secure mortgage money.

The United States Supreme Court having upheld the constitutionality of the New York and District of Columbia anti-profiteering rent laws, the rights of tenants would seem to be safeguarded.

Financing the Home Builder

Recent editorial comment in the *Saturday Evening Post*, discussing the work of building and loan associations, endorses them, stating that the reasons for their success, notably in Ohio and Pennsylvania, are quite apparent. They are, according to this analysis, strictly co-operative societies. They are self-contained institutions. Members are not only in the position of saving-bank depositors, but they assume the functions of bank directors as well, and personally lend the accumulations of their own savings. Membership often consists largely of friends and neighbors, who have been acquainted from childhood. Their operations are in familiar neighborhoods, where present values and future trends are matters of common knowledge. Lenders and borrowers have a background of acquaintanceship. Still another advantage exists in regions where these associations have long been operating. Experience has perfected their organization, their rules, policies and methods. Procedure has become standardized until it is as nearly foolproof as human skill can make it.

The Building Situation in the Middle West

(By Special Correspondence to THE AMERICAN ARCHITECT)

CHICAGO.—Chicago is having a very difficult time in getting started on its proudly proclaimed \$150,000,000 building program. Six months ago it would have seemed a certainty that building would have been fully under way by this time; three months ago the certainty would have seemed less certain, and now it is getting to be more or less problematical.

The chief hitch continues to be the attitude of labor. A week or so ago, the contractors put it squarely up to union leaders in the building trades that labor must share part of the economy.

In spite of discouraging drawbacks and uncertainties, the building trade declines to be pessimistic, for leaders declare that the favorable signs outweigh the evil omens two to one. Instead of seeing trouble and delay in the decline in steel and brick, the builders profess to see an earlier resumption of activity and as to the complicated labor situation, they declare that union labor must either accept the 25% cut or wake up to find itself face the open shop on a very big scale.

One of the added signs of improvement is the better feeling in the money market toward building securities, real estate mortgages and other financial incidentals of building. S. W. Strauss & Company, a prominent local investment house, has co-operated in a plan which will make \$3,000,000 available for

the early construction of 300 two-flat buildings and work is just about to begin on this project, which is characterized by local real estate writers as the biggest housing project in Chicago since 1914.

Under the plan, the S. W. Strauss & Company aid will be extended to desirable applicants who can pay \$1,000 in cash and who are earning at least \$160 a month. The two-flat buildings are to be erected at a cost of \$10,000 each, of which the buyer will advance \$1,000, S. W. Strauss & Company \$6,000, and Mills & Sons, the builders, \$3,000.

The first 300 buildings are to be erected at North Avenue and Sixtieth Avenue, and this first important group will merely be the forerunner of an even greater two-flat project if the plan proves popular with the public. Local bankers say that practically unlimited funds are available on these terms or terms almost as reasonable.

S. W. Strauss & Company are also financing a 100-flat building. Work has been started at Drexel Boulevard and Forty-third Street. The building will cost \$425,000.

Another interesting building development of the week is the announcement of the award of contract for the new union station mail terminal. J. D'Esposito, chief engineer, announces that the contract has been given to R. C. Wieboldt & Company at an

THE AMERICAN ARCHITECT

approximate estimate of \$3,000,000. Figures on the labor involved in the building were based on the proposed new wage scale over which the contractors and union builders are now haggling. In other words, the station cannot be constructed at the estimate given unless labor decides to accept the 25% reduction from the present scale of \$1.25 per hour for carpenters and \$1.00 per hour for unskilled union labor.

In this connection it is interesting to observe that the unskilled union labor is very willing to accept the cut of 25%, but that the principal objection to the reduction is coming from the carpenters and other skilled divisions of building labor.

Labor is being prominently unveiled at the legislative inquiry into Chicago building conditions. More properly speaking, union leaders' machinations are being revealed. Witnesses appeared before the joint committee and have brought to light the so-called "maintenance graft," which is said to have been practiced on practically every large building erected in Chicago in recent years and more particularly during the rush building period of the last year or so. The maintenance idea, in effect, calls for the employment of "maintenance agents" at high salaries to see that work is carried forward with promptness and dispatch. In truth, these agents are on the pay-roll as a sort of insurance against jurisdictional strikes and other disputes which were calculated to call a halt on construction at a time when buildings were urgently needed. While the legislative hearing has not been open to the public, it is reported that most of the Loop buildings of recent construction have been victims of this "shakedown" system.

The legislative hearing is also revealing the iron-clad nature of the blockade maintained against out-of-town building materials, whether union made or not. For one thing, this alleged agreement between contractors, union leaders and material manufacturers, has been effective in preventing the construction in Chicago of any fabricated houses. A hundred or so witnesses have appeared before the committee and some very startling revelations are said to have been made.

Suburban building activity continues to be more interesting than building within the corporate limits of Chicago. The latest suburb to come to the bat with a big building project is Brookfield, a western suburb. Two hundred or more homes ranging from \$7,500 each are to be built in that suburb before October 1. Twenty-five of the houses are already under construction and are to be ready for occupancy by May 1.

Architects report an increasing interest in the cooperative apartment building idea. Such a plan has

been very successful in New York, it is reported here, and local builders are anxious to see how the plan works out here. In substance, the promoter of the plan gets a dozen or so investors interested in constructing an apartment building in which all will live and which will be erected under joint ownership. The idea appeals rather strongly to the over-taxed rent payers and it is likely that a number of such buildings will be erected during the approaching summer and fall. Building for immediate occupancy is not now being pressed, owing to the fact that May 1 moving day is too near at hand. October 1, the next important moving day in Chicago, will be anticipated, however, by extensive building of homes and small apartments.

Building materials hold at practically old levels. Lumber is also quiet, as to demand, that present prices would not hold if a sudden demand really came along to stimulate competitive bidding. Common building brick has suffered slight decline during the present week, dropping from \$16 to \$12 per thousand. Present prices in the lumber and materials market are:

Yellow Pine: B. & B. 1-in., \$95 to \$130, depending on thickness; 2 x 4, No. 1, 10 to 16 ft. length, \$51 to \$53; 2 x 6, \$48; 2 x 8, \$50; 2 x 10, \$53; 2 x 12, \$55; 13-16 x 3 1-4 z & b flat flooring, \$85 to \$90; 1 x 6, No. 2 common, \$48 to \$90. *Douglas Fir*: 2 4 S, in sizes up to 12 x 12, in length up to 32 ft., \$65 to \$70; 14 x 14, \$68 to \$73; 16 x 16, \$72 to \$75; 18 x 18, \$75 to \$80. *Hard Maple*: Four 1/4 No. 1 and 2, \$135; select, \$120; No. 1 common, \$100; No. 2 common, \$65; No. 3 common, \$32. *Birch*: Four 1/4 No. 1 and 2, \$160; select, \$133 to \$138; No. 1 common, \$95 to \$100; No. 2 common, \$60 to \$65; No. 3 common, \$40. *Red Gum*: Four 1/4 No. 1 and 2, \$150; No. 1 common, \$90 to \$92; No. 2 common, \$45.

Face Brick—Standard, vitrified red, \$32.00@34.00; Smooth, Indiana red, \$38.00@40.00; Smooth, Ohio red, \$38.00@40.00; Smooth, Pennsylvania red, \$46.00@48.00; Smooth, buff, \$45.00@47.00; Smooth, gray, \$47.00@49.00; Rough, buff, \$44.00@46.00; Rough, gray, \$47.00@49.00; Variegated, rough texture, \$34.00@49.00.

Common brick, \$13.00 to \$16.00 per M. Portland cement, \$2.25 per bbl. Torpedo—Lake and bank sand, \$3.50 per yd. Crushed stone, gravel screenings, \$3.50 per yd. Hydrated lime, Ohio, paper, \$21.00 per ton. Hydrated lime, Ohio, cloth, \$29.00 per ton. (Includes sacks at 30c each). Hydrated lime, Wisconsin, paper, \$19.00 per ton. Bulk lime, \$1.65 per ton.

Building Conditions on the Pacific Coast

(Special Correspondence to THE AMERICAN ARCHITECT)

SEATTLE.—There has been another reduction in sheet metals used in building construction of 50 cents per hundred pounds, and the tendency of nails and pipe is downward. Cement declined 15 cents, due exclusively to the fall in the price of cement bags, the material itself remaining firm. Roofing, lath, plaster and brick are plentiful on the Coast, but manufacturers seem inclined to hold prices steady. Fir lumber is steady to stronger, especially in common dimension.

Probably the most gratifying feature of the week was the increase in the demand for building essentials in the country. While building in the Coast cities is quiet, excepting in one or two cities of California, the small town and country business has been very heavy this spring, further corroborating the predictions of jobbers last winter that if healthy building engagements were undertaken this year it would first have to come from the country. From this fact strong hopes are being built on the present outlook.

Jobbers are now prepared to handle any demand that may arise during the next three months for sheets, pipe and nails. Stocks ordered earlier are about through arriving. Cement is stationary. The plants have no storage for reserve stocks, and the prospects for a heavy summer's road building program are keeping the market strong. Jobbers frankly say they expect no price recessions in cement this summer.

Efforts are being made by Puget Sound jobbing interests to hold the market on nails, but some of the Oregon jobbers, for purposes which have not been disclosed, are endeavoring to force quotations lower into mutual distributive territory.

There is to be no surplus of brick. All delivery is being made through a central agency, and regardless of what company sells, the order will funnel

into and out of the main channel. This brick delivery plan is the outgrowth of ruinous price cutting of a few years ago when reputable manufacturers were driven out of business because of inability to meet competitive quotations.

The fir lumber market is steady to strong. Average sales at the fir mills in all yard or building sizes have averaged \$48 to \$52 for 1 x 4 No. 2 and better vertical grain flooring and \$18 to \$25 for the No. 3, \$19 for slash grain in No. 2 and \$20.75 to \$24 for the No. 2 and better; 1 x 6, 1 x 8-10 in. finish was \$46; five-eighths by four No. 2 and better ceiling, \$16 to \$23; 1 x 6 No. 2 and better drop siding, \$20 to \$23; \$12.50 to \$13.50 for boards and shiplap; \$10.50 to \$13.50 for common dimension, and \$16.50 for plank and small timbers.

Fully 75 per cent. of the fir lumber mills will be in operation within ten days. Shingle mills up to 65 per cent. are now running. The log market is weak. Wholesalers have been selling short on futures, expecting the decline in logs to bring down lumber quotations.

There were 1,196 building permits issued in Seattle for March, of which 610 were for frame structures, three for ordinary masonry buildings, two for slow burning construction units, two for fire-proof structures, 42 for moving or demolishing and 566 for alterations. The total value of work to be performed, according to these permits, is \$923,180. No really large projects were started last month. Segregated, four were for warehouses and wholesale buildings, 14 for office and retail store buildings, two for churches and theatres, four for hotels and apartment houses, 225 for detached residences and 388 for outbuildings.

Architects of Seattle report that, according to the slow start made in the season's building, the summer will be well advanced before local permits overtake last year's construction totals.

506^u

Frontispiece to No 2066



ENTRANCE DETAIL.
ANDREW SAFFORD HOUSE, WASHINGTON SQUARE, SALEM, MASS.
SAMUEL MCINTIRE, ARCHITECT

THE AMERICAN ARCHITECT

VOL. CXIX

WEDNESDAY, APRIL 27, 1921

NUMBER 2366



THE OLD BAKERY, ERECTED 1683 ON WASHINGTON STREET AND IN 1911 MOVED TO THE REAR OF THE HOUSE OF SEVEN GABLES ON TURNER STREET AND RESTORED

Old Salem Houses

Supplementing a Preceding Article on Samuel McIntire and His Times

By W. H. HUNT, *Architect.*

IN a preceding article on the life and work of Samuel McIntire, architect-builder, it was stated that little was known as to the identity of the architects and builders of houses erected in Salem, Mass., prior to 1780. From that date on, however, it is more certainly known just to whom to attribute the work of Salem's old houses and it is possible for the critical observer to trace the influence of McIntire and his contemporary architect-builders on the many buildings that are yet extant.

An architectural pilgrimage through this quaint New England town is one that will repay the archi-

tect and student, and while Salem's old houses and their detailings have been very generally described it will not be without interest, perhaps, further to set down some account of these famous old structures and perhaps add to each some facts of interest not already put into print.

Few cities in the United States can boast of so many well preserved houses still occupied by the best families. It seems almost a miracle that its beauties have been so abundantly preserved. Much of the old woodwork on the exterior and interior of these old houses is in a remarkably perfect condition.

THE AMERICAN ARCHITECT

Many of the streets are lined with houses to which most of our old citizens point with pride, because of their well preserved beauty, their age, and the manner in which they have been maintained, in many instances for more than a century. To wander about the old streets and see the old houses and gardens is to see a vivid reflection of that age when Salem was

building became a fine art, and her sailing vessels were considered as good or better than anything on the seas. With great courage and foresight many of these shipowners entered into business relations with the East Indies and other ports of the old world never before reached by trading vessels, and Salem became our chief port of entry many years



FRONT ELEVATION

RICHARD-DERBY HOUSE, SALEM, MASS.

SAMUEL McINTIRE, ARCHITECT

(This is the oldest brick building now standing in Salem)

ERECTED 1761

counted among the principal centers of culture and wealth. Many leaders in art and science were familiar figures in the streets, and many prosperous merchants and prominent statesmen called Salem their home.

After its settlement Salem quickly attained a great commercial importance. The harbor at that time was one of the best on the New England coast. Ship-

before Boston, New York or Philadelphia were known to the merchants of the East. During thirty years prior to 1811 Salem merchants paid into the Custom House duties of more than eleven million dollars, which gives us some idea of the tremendous amount of their business. It seems that the shipping and the number of vessels sailing from this port had about reached its height at that time. During the

THE AMERICAN ARCHITECT

twenty-five years prior to 1807 the shipowners and captains of the vessels trading with foreign ports became very wealthy, and many of them built at that time some of our best old homes, which will be described later in this article. The refining influence of their extensive foreign travels created a natural desire for a better standard of living. Many of them had collected rare furniture, wall papers and objects of art, which called for appropriate home surroundings in which to display them. This provided a higher type of employment for housewrights, skilled joiners and wood carvers, who had had vast experience in the finishing of the finest cabins of the ships,

those days. Many of these houses were a simple gable-roof structure, and as additional room was needed for the growing families wings and gables were thrown out as occasion demanded.

Many of these houses were made famous by the writings of Nathaniel Hawthorne. Notable among those was the house at 54 Turner Street, which derived its name from the title of his book, "The House of Seven Gables," and for many years has been known and referred to under that name. Many of the other houses above referred to were drawn upon largely by Hawthorne in his writings. It has been said that the House of Seven Gables was so in-

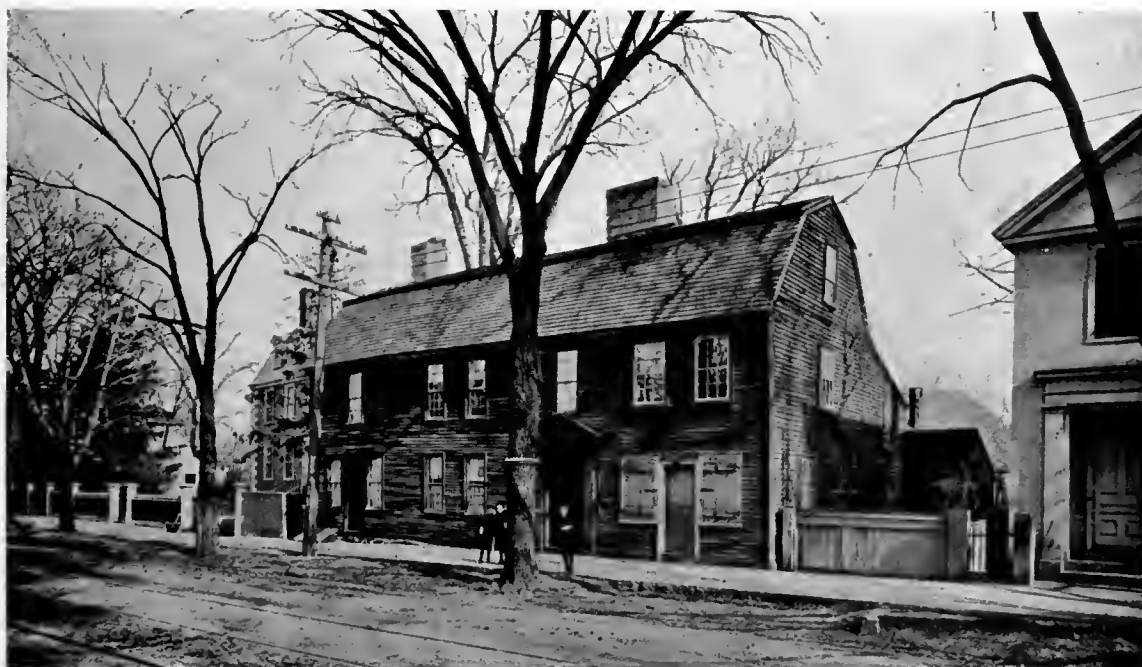

JEFFREY LANG HOUSE, ESSEX STREET, SALEM, MASS.

SAMUEL McINTIRE, ARCHITECT
ERECTED 1740—TAKEN DOWN 1900

and many of them found employment on the best homes built at that period.

The early architecture of Salem might be divided into three types developed in different periods. The first type of interest to students of architecture would date from the latter half of the seventeenth century and would comprise the gabled roof and the lean-to house. Prior to that time most of the houses were small gable-roof cottages; then came the larger peaked-roof house, or houses with many gables patterned after the English Elizabethan type. It seemed to be the custom, as larger houses were required, to add a lean-to across the back or along one side. The first houses in Salem of note were of the Elizabethan type, built entirely of wood, brick being little used in

timately associated with the story of that name, and in fact with his whole literary career, as to have justified the appellation. For many years this house was occupied by relatives of Hawthorne, and he was a frequent visitor there, and it is said that during his visits he received much of his literary inspiration. It appears that the house was enlarged from time to time, and several alterations to the interior were made; the woodwork of the parlor seems to be of later date than the house. Some time between 1885 and 1890 the big, old-fashioned chimney was removed, and on the fireback was found the date of 1669, which is thought to be the date that the house was erected.

Through the generosity and influence of Miss

THE AMERICAN ARCHITECT

Caroline O. Emmerton, in 1909 the house was restored throughout to practically its former character and made the center of a neighborhood settlement. The Seaman's Bethel, which for many years stood in front of it, has been removed to the rear and altered for settlement needs. This gives a view upon the harbor as it did in earlier days.

The Pickering house, at No. 18 Broad Street, erected about 1660 by John Pickering, is one of the oldest dwellings now remaining in Salem, and one of the few remaining examples of the many gabled

houses, we find large rooms. At the right is the library, which was probably a chamber before the room was enlarged. At the present time it has several bookcases filled with rare old books and has a fine old Colonial fireplace and mantel. Opposite is a large drawing-room filled with Chippendale and Colonial furniture. At the rear is the dining room.

This house is considered one of the most important landmarks in Salem, and has never been out of the Pickering family, and with one exception has descended to a John Pickering ever since it was erected.



PICKERING HOUSE, BROAD STREET, SALEM, MASS. ERECTED 1660

houses with steep roofs patterned after the half-timbered cottages of England.

This house is Gothic and built in the Elizabethan style of architecture, and resembles the famous Peacock Inn in Rouseley, England. The lean-to on the rear has a much flatter pitch than the main house, and appears to be an addition made within a few years after the original house was erected.

About 1841 extensive alterations and repairs were made. The exterior is practically unchanged; the interior shows beamed ceilings and many small windows. Several changes were made to the interior, such as lengthening the hall by removing one of the chimneys. On either side of the hall, as in many old

Few, if any, other historic homes can be found that have been in a direct line of a family for nine generations.

The type of house known as the lean-to is of considerable interest, as they came at a time with the waning of the Elizabethan houses. In some instances they continue certain features of their predecessors, such as the overhanging second story. Builders sought to enlarge the ground floor of some of the old pitch-roof houses by adding a one-story shed roof or single pitch-roof across the rear or at one end. Later, many of the new houses with the lean-to were built as one with the main house. A lean-to was joined to the house in several ways, but was usually

THE AMERICAN ARCHITECT

built with a continuation of the back side of the main roof at the same pitch, with the result that while the house was a two-story on the front, it was one-story on the rear. Rarely was a lean-to placed across the gable-end of the main building, except when built on as an addition. Many modern houses of recent date have been patterned after some of the old lean-to houses. Among houses of this type is the Hooper house, known as the "Old Bakery," formerly at No. 23 Washington Street, erected in 1683, a two-story house with the second story overhanging

reflect the simplicity of the life and the character of the early settlers. They show us that the necessities were supplied in the most direct way and that very little attempt was made for ornamentation, either on the exterior or interior. The exterior trim, including the corners, verge boards, entrances and windows, are severely plain. The interiors in most cases are very simple, and were a great contrast to the elaboration and decorative detail which we find accompanied the advent of the gambrel-roof house and the Colonial architecture which followed later.



CABOT-ENDICOTT-LOW HOUSE, ESSEX STREET, SALEM, MASS.
SAMUEL McINTIRE, ARCHITECT
ERECTED 1745

on the front and a lean-to on the back. The second story, or overhang, is supported by heavy oak girders with chamfered edges and ends carved, showing a simple form of ornamental brackets. The spaces between studding are filled with brick laid in clay. The laths were split from a log. Many features of this building stood in its original condition, and in 1911 it was moved to the rear of the House of Seven Gables on Turner Street and thoroughly restored.

In the John Ward house, originally at No. 38 St. Peter Street, built about 1684 by John Ward, the lean-to across the rear had a flatter pitch than the roof of the main house and was probably added after the original house was erected.

The dwellings before described, without exception,

GAMBREL-ROOF HOUSES

The type of dwelling that began to be erected in the latter part of the seventeenth century and the early part of the eighteenth century marked a decided difference from the peaked-roof and lean-to houses before described. During those years the gambrel-roof house was the prevailing style, at first small and very simple, but toward the middle of the eighteenth century it developed into some of the largest and most distinctive types of American residence.

The gambrel-roof represents an evolution of the seventeenth century Mansard roof, designed by the distinguished French architect, François Mansard, in 1598 to 1666, which was extensively adopted in France and other European countries. Quite a few-

THE AMERICAN ARCHITECT

Mansard-roof houses were built in Salem and vicinity, but did not seem to meet with much favor; therefore a popularity of the gambrel-roof house which came into favor at that time, and has been popular in this section as well as many other parts of the country ever since.

Many of the existing gable-roof and lean-to structures were remodeled into gambrel-roof houses. In most cases, at that period, they were without dormers and devoid of architectural embellishment, either of doorway or exterior trim. Toward the middle of the eighteenth century great improvement was made in the character of the residences. Many merchants and sea captains were accumulating fortunes, and they began to build much better residences than had been the custom hitherto. Their travels brought them in contact with the architecture of foreign countries, and about that period the influence of Georgian architecture began to be felt in this vicinity. New England builders had for ready reference little books of measured drawings of excellent details.

During the eighteenth century there were several gambrel lean-to houses with front showing a gambrel roof with a long, sloping roof on the rear. Among the most noteworthy was the Wheatland house at No. 374 Essex Street, erected about 1773; the Jeffrey Lang house at No. 371 Essex Street, erected in 1744.

One of the first brick houses in Salem was a gambrel-roof residence built by Richard Derby in 1761 at No. 168 Derby Street. This house is of Georgian type. It has a fine classic doorway built of wood worked out in imitation of marble. The feature of the brickwork is seen in the projecting band at the level of the second floor. There are two large chimneys at each end of the house, the brick gable being carried up between the chimneys, making the chimneys part of the structural walls, the outside being flush with the outside of the chimneys. This gable construction became a prominent feature in many of the brick houses of later date.

One of the best houses built in the eighteenth century of the gambrel-roof type is the fine old house at No. 365 Essex Street, known as the Cabot-Endicott-Low house. This dwelling was erected in 1745 by Joseph Cabot, from the design of an English architect, who was also the architect for several of the best residences built in New England about that period. This house is of the purest Colonial type, and for years has been a subject of great interest to architects all over the country.

The gambrel-roof is well proportioned; there are five closely spaced dormer windows on the roof, the center one having a segmental pediment, and the two at each side having gables. The gutter and verge boards are all molded, and the door and window trim throughout show Georgian type. The doorway is

elaborate and well proportioned. This house is noted for its interior woodwork. A large hall running through the center has one of the best stairways to be found in Salem, with its twisted newel post and balusters, and heavy molded mahogany rail. The box stairs with paneled ends show decorative brackets. Of special note is the fact that the twisted portion of the balusters at each tread differs, although the tops and bottoms are alike. The newel post and balusters, which are hand-carved and turned, represent a direct development of work found in ship cabins in their likeness to rope molding so much used in those days.

Of the gambrel-roof houses built in this section of New England it seems that no recognized rule was followed for the proportion or pitch, but the roof was adapted to the general size and character of the house.

THE THREE-STORY HOUSE

In the latter part of the eighteenth century, the square three-story wooden house became the prevailing style. The third-story windows in most cases were shortened. Several were built with a gable-roof with quite a flat pitch, similar to the Stearn's house at 384 Essex Street. Most of the houses of that period had plain clapboard walls, but occasionally we find them with quin corners to represent marble.

The houses of this period are usually referred to as square three-story structures, but we find many of them oblong; some with the short side fronting on the street, and others the long side on the street. Most of the houses of that type had an ell at the rear, providing kitchen and service rooms on first floor and servants' chambers on the second. In many of them the ell was two stories in height, and in many cases the stories were of lower stud in the ell than in the main house, the first floor being on the same level and the second floor two or three steps down from the floor of the main house.

Very few of those substantial three-story mansions are to be found outside of New England, and nowhere in such number and perfection as in Salem. They possess a certain architectural stateliness and as the town building sites were somewhat restricted in area they appear practical. We find that the remarkable craftsmanship of the time asserted itself upon the exterior, and we have many examples of the genuine distinction and rare beauty imparted on those square box-like structures, through the agency of fences, gateways, entrance porches, door and window heads, etc. Most of these mansions were built by sea captains and merchants who had become wealthy through their East India trade. Many of them felt the need of a look-out to watch for the return of their vessels, and therefore built a cupola on the roof. One of the best examples of the cupola popular in those days still exists. It was on the Pickman-

Derby-Brookhouse mansion at No. 70 Washington Street. The house was razed in 1915 to make room for the new Masonic Temple started that year, but the cupola was moved to the garden of the Essex Institute.

The Stearns house at No. 384 Essex Street, erected in 1776, is of the oblong shape, the broad side on the street with a rather flat gable. The house is notably

attractive for its handsome Doric porch, designed and added by Samuel McIntire in 1785. It will be noted from the illustration that this porch differs from many others in Salem by the addition of flat pilasters at each side, which give increased breadth and dignity. Although it seems well proportioned for this particular house, it would be better suited to public buildings than residential work.

National Council of Architectural Registration Boards

A general statement with special reference to examinations and qualifications of applicants to practice architecture has been prepared by the National Council of Architectural Registration Boards.

Applicants will be divided into two classes, Junior and Senior.

The Junior Class will include those having less than ten years' proved architectural practice as a principal or one of a group of principals in charge of an architect's office, and all falling under this group should be required to take a written and delineation test, supplemented by a verbal quiz at the discretion of the examining committee, which shall embrace the subjects and time requirements set forth in the Standard N. C. A. R. outline for such examination.

The Senior Class will be made up of those having ten or more years' proved architectural practice as a principal or one of a group of principals in charge of an architect's office engaged in the practice of architecture as a profession. The examination of the latter class is to be by exhibits of sketches, working drawings, details, and specifications prepared under the personal supervision of the applicant, supplemented by a verbal quiz as to the reasons for methods used, procedure shown, and evidence of authorship; these to be supplemented by proof of honorable practice, photographs of executed work, or any or all of these, which in the judgment of the examining committee are necessary to determine the applicant's qualifications as an

architect. These qualifications in the opinion of the examiners shall be equivalent to or superior in relative value to the requirements set forth for applicants having had less than ten years' experience.

This statement sets forth at considerable length, but very clearly, the essential qualifications and minimum of educational and practical experience as regarding proper preparation for entrance upon the independent practice of architecture as a profession. Natural ability is logically placed first among these essentials.

The details of the examinations in these two classes have been very carefully worked out and it is believed they would meet all of the minimum requirements of all States having laws regulating the practice of architecture. This part of the report has been covered in the most exhaustive and thorough way.

Circular of Advice No. 2, from which the foregoing information has been gleaned, is a voluminous document, but sufficiently important to warrant perusal by every member of the profession of architecture. It shows a most comprehensive grasp of the now all important matter of architectural registration. The work of this Council has from the outset been thorough and efficient. If its work is properly endorsed by the profession and its recommendations generally approved, it will secure results of lasting value to every member of the architectural profession. The address of the National Council is 3230 W. Monroe Street, Chicago.

Old Custom House, Philadelphia, Pa.*

(See reproduction of original drawing by O. R. Eggers on opposite page)

T*HIS fine old building was built in 1819 for the United States Bank. In 1845 it became the Custom House.*

Designed by William Strickland, it represents his work at the early period of his activities as an architect.

William Strickland and Robert Mills, contemporaneous, dominated the public buildings in this country. They dictated the public taste in architecture for a full generation.

The classic or Greek Revival was the dominating motive of all of their buildings and it is safe to assume that the structures erected by the government from about 1820 were either designed or largely influenced by either Strickland (1787-1854) or Mills (1781-1885).

*The correct title of the subject presented on the following page is as stated in the heading above. The error in title was discovered too late for correction on the accompanying drawing.

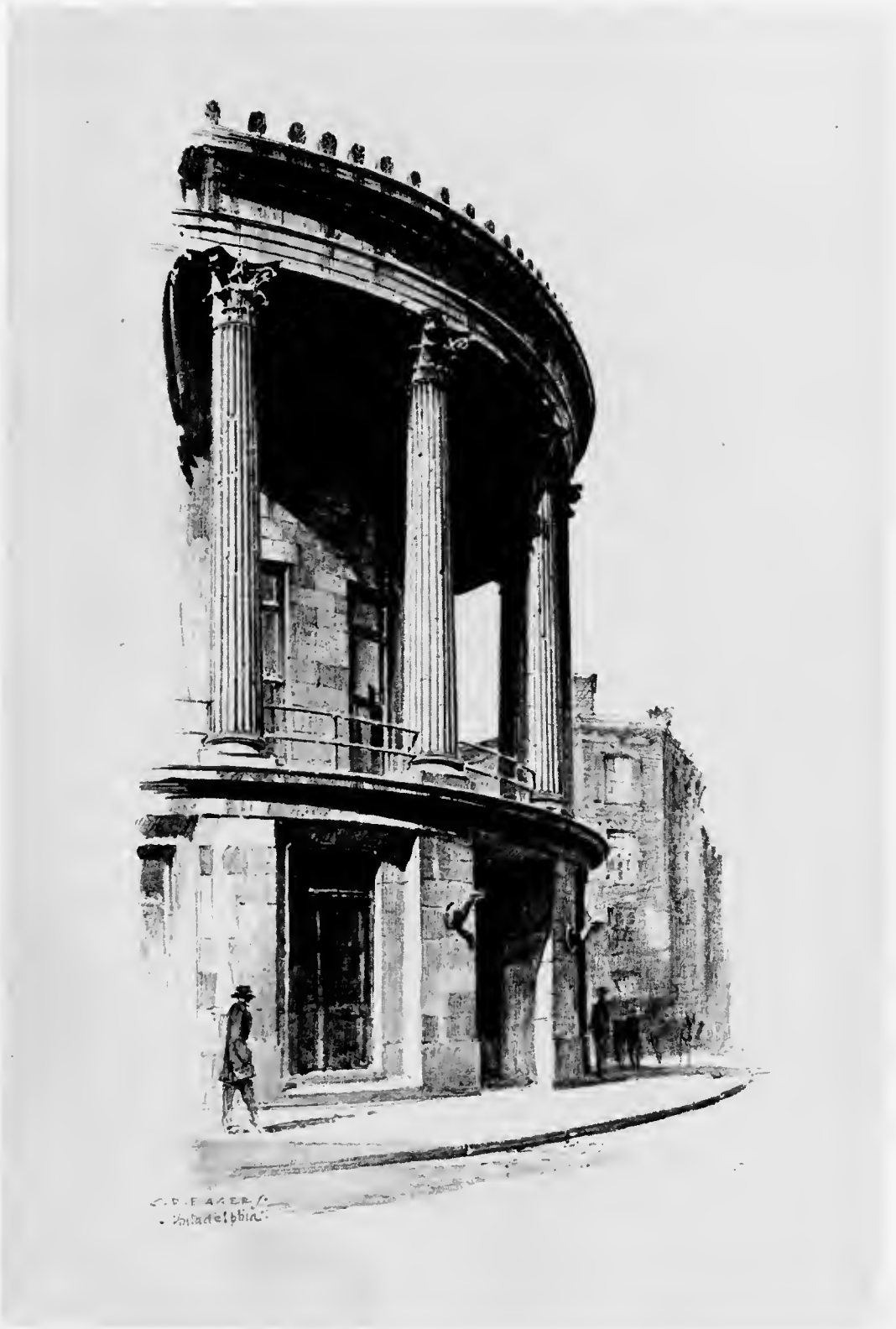

OLD CUSTOM HOUSE, PHILADELPHIA, PA.
THE AMERICAN ARCHITECT Series of Early American Architecture



Announcement

SINCE the close of the World War **THE AMERICAN ARCHITECT** has increased the number of its subscribers 68 per cent. In fact, there has never been a time from its foundation, in 1876, that this journal has shown greater progress than has marked it since the Armistice.

Nevertheless, its publishers have, during recent months, sensed changed conditions. It finally became quite apparent to them that new viewpoints have been developed, and new habits have been formed. In their constant effort to meet, as nearly as possible, the needs of their readers, they have conducted an extended investigation, and, as a result, have reached the conclusion that the requirements of the majority could now be more closely met by a bi-weekly publication than by one of either more or less frequent issue.

Accordingly, beginning in May (issue of May 11), **THE AMERICAN ARCHITECT** will be published every other Wednesday. The subscription price for delivery in the United States and possessions will be reduced to \$6.00 per year.

THE AMERICAN ARCHITECT has in the past been a practically indispensable aid in the larger architectural offices. Under the new plan, it is proposed to produce a magazine to which every office, no matter what its volume of work may be, can afford to subscribe. It is perhaps unnecessary to add that **THE AMERICAN ARCHITECT** as a bi-weekly will be a larger magazine, of better appearance and one the publishers believe will merit unqualified approval.

Publishers,

THE AMERICAN ARCHITECT.

Annual Convention of the A. I. A.

THE annual convention of the American Institute of Architects, to be held in Washington in May, will undoubtedly be one of the most important of recent years. The Illinois Chapter, with a view to securing the largest measure of constructive effort, has, by a series of resolutions, presented to the Board of Directors, sought to suggest a certain line of pro-

cedure that will secure that desirable result. The problems that now confront the profession are serious and practical ones. It is sufficiently guarded by canons of ethics, of circulars of advice. These at best are but academic matters and, as a fact, are sometimes more honored in the breach than in the observance.

The architectural profession may, as far as practical effort is concerned, seriously study what the engineering societies, the contractor-builder organizations have been doing and what, in doing those things, they have really accomplished.

We have always had reason to mention approvingly the very fine and thorough reports that are presented at Institute conventions each year, just as we have had reason to deplore their ultimate fate and the lack of continuation of effort along such well-planned lines. It would be better to take one large outstanding problem, and try for its solution, than to spend hours in the academic discussion of a lot of matters purely visionary.

The Illinois Chapter has suggested that the convention seriously concern itself with legislation now pending that directly affects the practice of architecture. The suggestion would seem to be a good one.

Sketching for Architects

VACATION time will soon be here. Perhaps, in view of the stagnation in building, most architects will not need a vacation. Also, perhaps the sort of a "vacation" they would most enjoy would be one of old-time, strenuous activity in the service of clients. But when the "Call of the Wild" is heard, and the lure of green fields is felt, most men will welcome and seek a change from the drab monotony of life in cities.

Architects need to have a good sense of form and color. Of course, they must know how to draw and be able to set down their impressions. No form of recreation brings with it larger compensation than sketching from nature. The man who will take a sketch box, go afield and spend a few hours each day in painting, will have found the most mind-resting thing there is.

Beaux-Arts Institute of Design

DIRECTOR OF THE INSTITUTE, LLOYD WARREN

ARCHITECTURE, RAYMOND M. HOOD
SCULPTURE, JOHN GREGORY

INTERIOR DECORATION, ERNEST F. TYLER
MURAL PAINTING, ERNEST C. PEIXOTTO

Official Notification of Awards—Judgment of March 8, 1921.

FIRST PRELIMINARY COMPETITION FOR THE
14TH PARIS PRIZE

of the
SOCIETY OF BEAUX-ARTS ARCHITECTS.
PROGRAM

The Annual Committee of the Paris Prize proposes as
subject of this Competition:
A MEMORIAL MUSEUM

GENERAL:

A wealthy patron of the Arts has bequeathed to the people of his city his collections of paintings, sculpture, furniture and ceramics with a provision that these collections

be permanently and suitably housed in a special building bearing his name. It is proposed to erect this Memorial Museum in the grounds where the City Museum of Art is already situated and to connect them by an enclosed arcade, colonnade, gallery, or loggia.

The Memorial Museum (like the City Museum) shall face a wide parkway and be entered across a spacious forecourt slightly higher than the level of the parkway and treated in such a manner as to give a proper setting for several of the larger marbles or bronzes forming part of the collections. The building shall be one story high and shall contain, in addition to the gallery or galleries for the collections, an entrance vestibule, check room, toilet facilities for both sexes, and a small room for the sale of photographs of the collections.

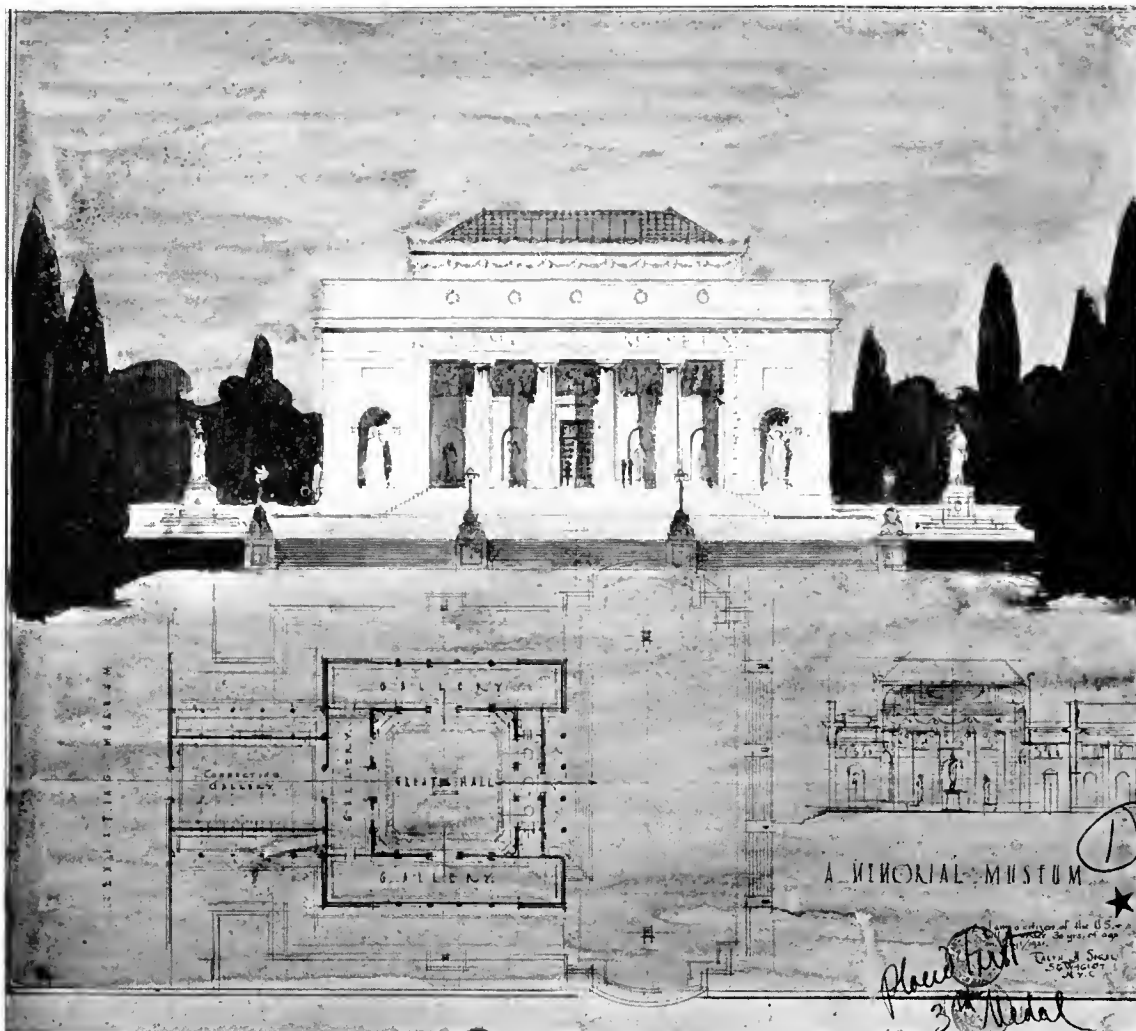

R. H. SEGAL

NEW YORK CITY

PLACED FIRST (3rd MEDAL)
FIRST PRELIMINARY COMPETITION, PARIS PRIZE

THE AMERICAN ARCHITECT

DIMENSIONS:

The plan of the building shall not exceed 100 in its greater dimension.

JURY OF AWARD:

L. Warren, R. M. Hood, J. M. Howell, J. G. Rogers, C. Gilbert, W. S. Wagner and H. O. Milliken, chairman.

NUMBER OF DRAWINGS SUBMITTED: 102.

AWARDS:

Placed First (3d Medal): R. H. Segal, 56 West 46th Street, New York City.

Placed Second (1st Mention): R. H. Douglas, Pittsburgh A. C., Pittsburgh.

Placed Third (3d Medal): H. S. Atkinson, "T" Square Club, Philadelphia.

Placed Fourth (3d Medal): S. P. Stewart, University of Illinois, Urbana.

Placed Fifth (3d Medal): R. W. Craton, 430 West 118th Street, New York City.

Placed Sixth (1st Mention): L. Simpson, Washington University, St. Louis.

Placed Seventh (3d Medal): L. H. Pries, University of Pennsylvania, Philadelphia.

Placed Eighth (3d Medal): O. M. O'sen, University of Pennsylvania, Philadelphia.

Placed Ninth—First Alternate (3d Medal): L. S. Lashmit, Carnegie Institute of Technology, Pittsburgh.

Placed Tenth—Second Alternate (3d Medal): S. F. Swales, 543 West 123d Street, New York City.

Third Medal: G. D. Conner, Chicago School of Architecture, Chicago; L. Rich, Atelier Corbett-Gugler, New York City; A. E. Anderson, Pittsburgh A. C., Pittsburgh.

First Mention: J. T. Cronin, care Coolidge and Shattuck, Boston.

Mention: H. T. Aspinwall, Carnegie Institute of Technology, Pittsburgh; G. Fraser, R. D. McPherson, H. G. Banse and F. H. Robinson, Cornell University, Ithaca; I. J. Loemb, Chicago School of Architecture, Chicago; H. W. Gill, Columbia University, New York City; R. L. Linder, Atelier Denver, Denver; L. A. Kruse, Harvard University, Cambridge; M. Jaeger, Jr., Atelier Hiron, New York City; W. F. Kussin, 110 State Street, Boston, Mass.; N. Larson, Post and Lintel Club, Minneapolis; W. S. Arrasmith, University of Illinois, Urbana; G. K. Geerlings and R. S. Potter, University of Pennsylvania, Philadelphia; O. Thorshov, University of Minnesota, Minneapolis; F. R. Hammond, Washington University, St. Louis.

Official Notification of Awards—Judgment of January 4, 1921.

PROGRAM

CLASS "A"—II PROJECT

The Committee on Architecture proposes as subject of this Competition:

"A STAIRCASE HALL"

The entrance floor of a city hall is connected with the main floor by a monumental staircase, which gives access at the upper level to the municipal council rooms and the mayor's offices. From this point on, secondary stairs lead to the upper floors.

The staircase should be designed to accord with the importance and sumptuous character of the rooms it serves, and the hall in which it is placed may be developed as a feature of the exterior composition of the building if desired. It is of great importance so to study the natural lighting of the staircase hall that it shall not only be

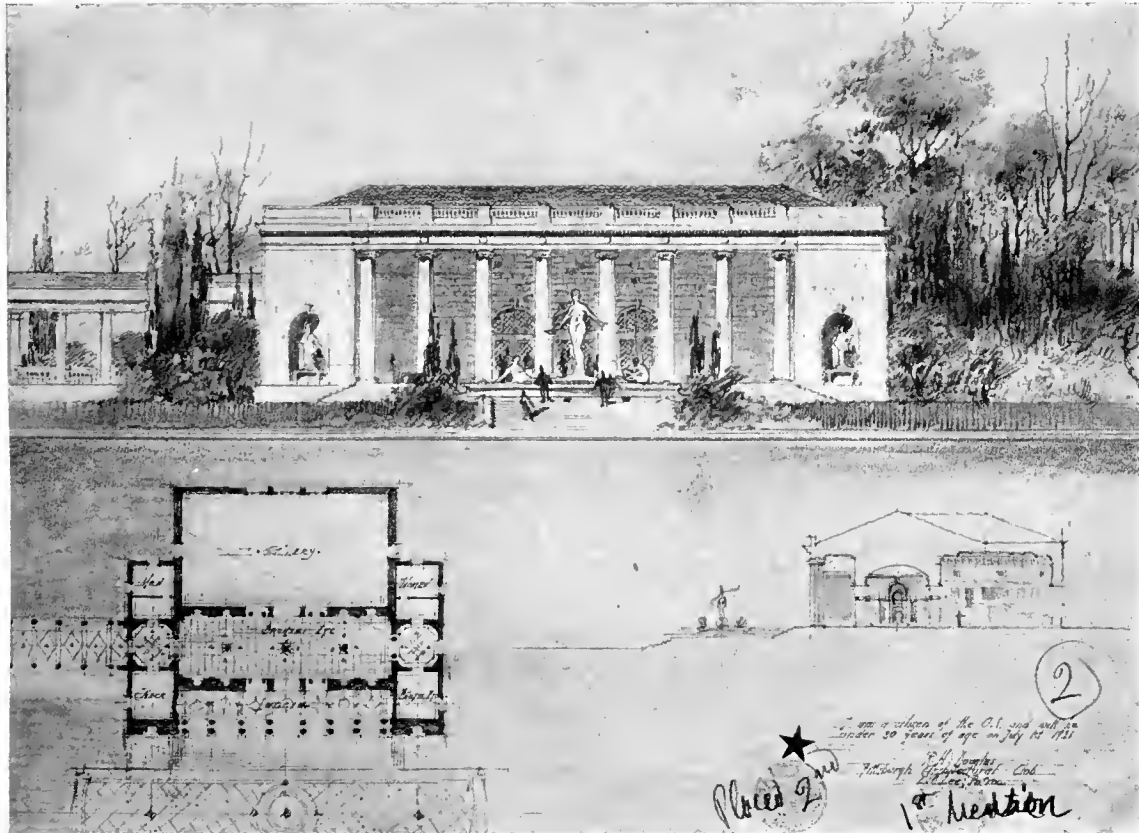

R. H. DOUGLAS

PITTSBURGH ARCHITECTURAL CLUB

PLACED SECOND (1st MENTION)
FIRST PRELIMINARY COMPETITION, PARIS PRIZE

THE AMERICAN ARCHITECT

ample and adequate, but also so arranged as to harmonize with and emphasize the architectural treatment of the interior. The disposition of the rooms and courts about the staircase hall is optional, save that on the first floor it should open directly out of the entrance vestibule. The distance from the first to the main floor level is 22'0". The entire height of the staircase hall is not limited, but its maximum floor area, measured within the walls of the surrounding rooms or courts, shall not exceed 9,000 square feet.

JURY OF AWARD:

R. M. Hood, F. A. Godley, F. C. Hiron, H. Hornbostel, H. W. Corbett, H. Davenport, H. Boehm, F. A. Nelson, W. Van Alen, P. P. Cret, L. P. Burnham, G. Howe, C. Mackenzie and H. B. Herts.

NUMBER OF DRAWINGS SUBMITTED: 71.
AWARDS:

First Medal: L. S. Lashmit and B. Dierks, Carnegie Institute of Technology, Pittsburgh; R. H. Bickel, Columbia University, New York City; G. K. Geerlings, University of Pennsylvania, Philadelphia.

Second Medal: M. Pohlmeier, L. J. Rockwell and P. F. Simpson, Carnegie Institute of Technology, Pittsburgh; K. Carver and E. K. Hunter, Cornell University, Ithaca; D.

R. Everson, Columbia University, New York City; R. DeGhetto, Atelier Hiron, New York City; A. Westover, Jr., "T" Square Club, Philadelphia; R. A. Fisher and G. W. Green, University of Pennsylvania, Philadelphia.

Mention: W. J. Perkins, H. A. Wieland, F. K. Draz, R. Schmertz, C. W. Hunt, H. T. Aspinwall and R. M. Crosby, Carnegie Institute of Technology, Pittsburgh; H. Nolan, E. B. Mason, R. D. McPherson, C. M. Stotz, G. Fraser, W. H. Harrison, T. Yokogawa and F. L. Abreu, Cornell University, Ithaca; H. J. R. Barrett, C. Contreras, C. H. Sherwood, E. W. Burkhardt and H. W. Gill, Columbia University, New York City; J. J. Loebel, S. C. Levi, H. L. Fassett, N. J. Schlossman and E. J. Manning, Chicago School of Architecture, Chicago; L. F. Fuller, Los Angeles A. C., Los Angeles; R. L. Goldberg, L. Z. Slawter and E. C. K. Schmidt, "T" Square Club, Philadelphia; G. K. Trautwein, G. A. Barry, K. A. McGrew, C. E. Jenkins, J. T. Briggs, E. O. John, L. H. Price and G. P. Turner, University of Pennsylvania, Philadelphia; W. M. Icenhower and L. F. Soxman, University of Kansas, Lawrence; T. F. Price, F. Elsasser and P. Jensen, Atelier Wynkoop, New York City; R. B. Thomas and L. Hamilton, Yale University, School of Fine Arts, New Haven.

H. C.: B. E. Irby and Mary L. Abbott, Columbia University, New York City; J. Lucchesi, Atelier Hiron, New

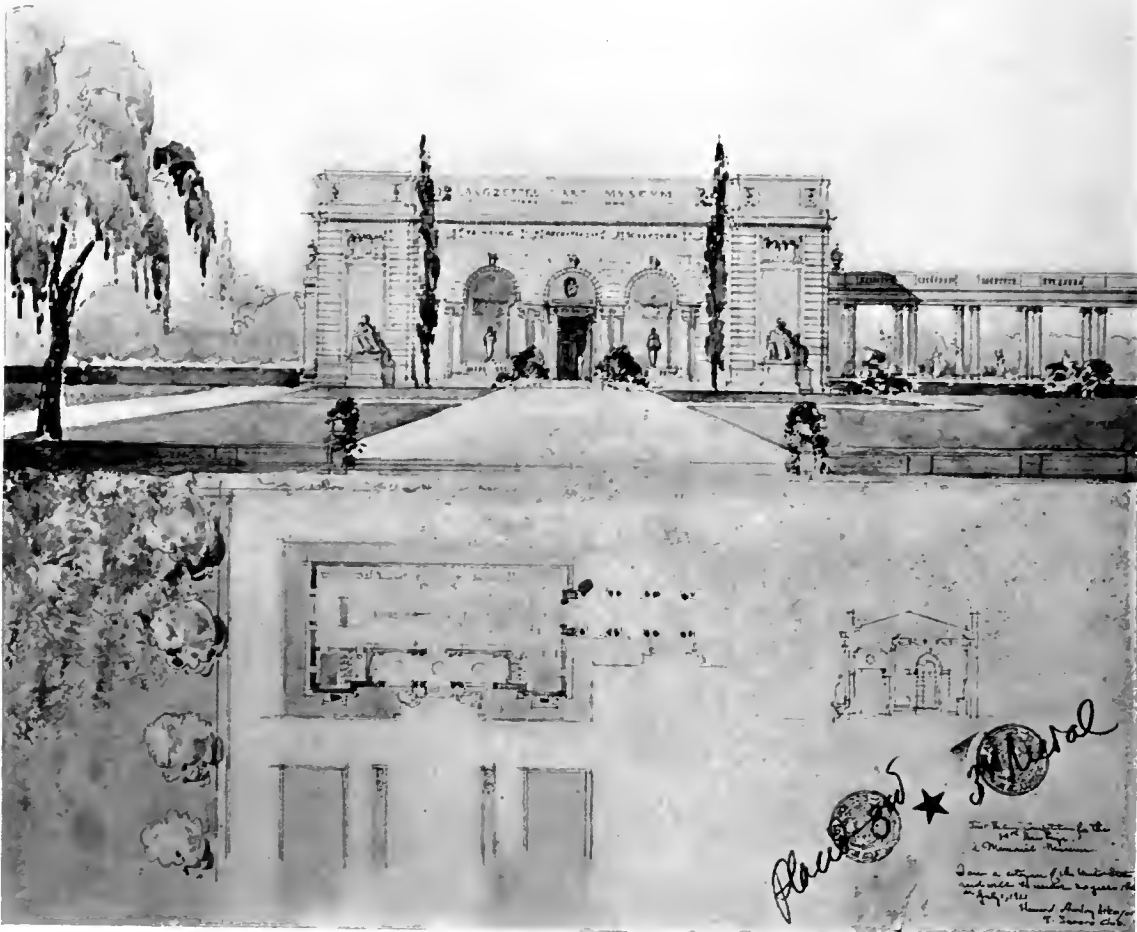

H. S. ATKINSON

"T" SQUARE CLUB, PHILADELPHIA

PLACED THIRD (3d MEDAL)

FIRST PRELIMINARY COMPETITION, PARIS PRIZE

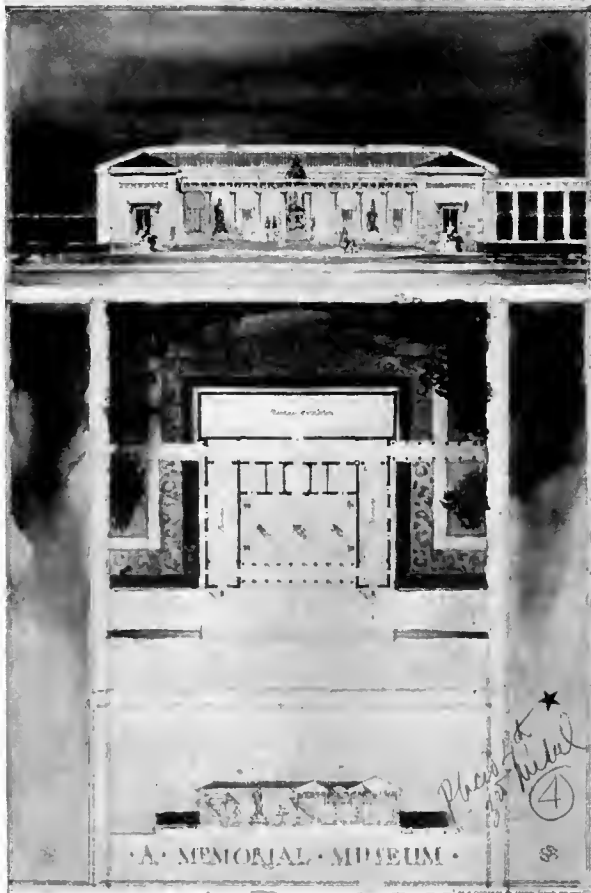

S. P. STEWART UNIVERSITY OF ILLINOIS
 PLACED FOURTH
 FIRST PRELIMINARY COMPETITION FOR
 THE 14TH PARIS PRIZE

York City; S. J. Laschenski, University of Pennsylvania, Philadelphia.

PROGRAM

CLASS "A"—II ESQUISSE-ESQUISSE.

The Committee on Architecture proposes as subject of this Competition:

"AN ENTRANCE TO A DANCE HALL"

As this establishment is only open at night, the appearance of the entrance by daylight is of minor consequence. The problem is essentially one of a night effect, produced either by an architecture of electric lights or an architecture artificially lighted by concealed or exposed lights.

The first requisite of the design of this entrance is that it should have "character," that is, it should express the use of the building to which it gives admittance. It should therefore be gay, festive and smart, with gracious curving lines and as it is to be a money-making venture it should also be arresting, inviting and if possible intriguing.

The problem is the composition and complete decoration of the entrance, which has a frontage of 25'0" on a sidewalk which is 10'0" wide. The owners are willing to give up an additional 10'0" to a recessed entrance motive, level with the sidewalk and extending to a height not to exceed 25'0". There should be an iron and glass marquee covering the entire sidewalk in front.

There will be no exterior ticket booth as in the movies,

but space should be definitely arranged for posters and illuminated signs.

JURY OF AWARD:

W. F. Lamb, J. W. Cross, Mr. Koyl, M. Prevot, H. R. Sedgwick, H. O. Milliken, T. Holden, H. P. Pennington and G. S. Parker.

NOTE: This Jury also served as Jury of Award for the Class "A" II Esquisse-Esquisse, Class "B" II Esquisse-Esquisse, and Class "A" & "B" Archaeology-II Project.

NUMBER OF DRAWINGS SUBMITTED: 26.

AWARDS:

Third Medal: G. Chittenden, Los Angeles A. C., Los Angeles; R. S. Potter, University of Pennsylvania, Philadelphia.

Mention: R. K. Galbraith, Architectural League of Indianapolis, Indianapolis; L. F. Fuller, Los Angeles A. C., Los Angeles; R. F. Larson, University of Pennsylvania, Philadelphia; F. A. Chapman, Atelier Wynkoop, New York City.

PROGRAM

CLASS "B"—II ESQUISSE-ESQUISSE

The Committee on Architecture proposes as subject of this Competition:

"THE DECORATION OF A CITY GARDEN"

The difficulty of obtaining suitable apartments and houses for rent that has been experienced in most of our cities for the past year or more, has been met in some degree by a person or a co-operative group buying a row of old houses and remodelling them to suit modern conditions. This

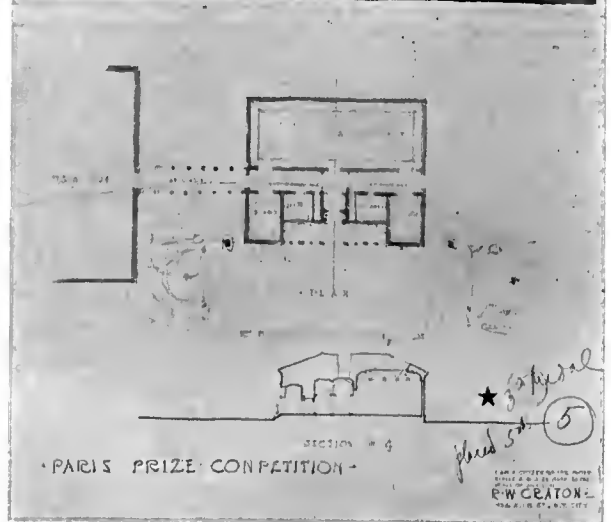

R. W. CRATON NEW YORK CITY
 PLACED FIFTH
 FIRST PRELIMINARY COMPETITION FOR
 THE 14TH PARIS PRIZE

THE AMERICAN ARCHITECT

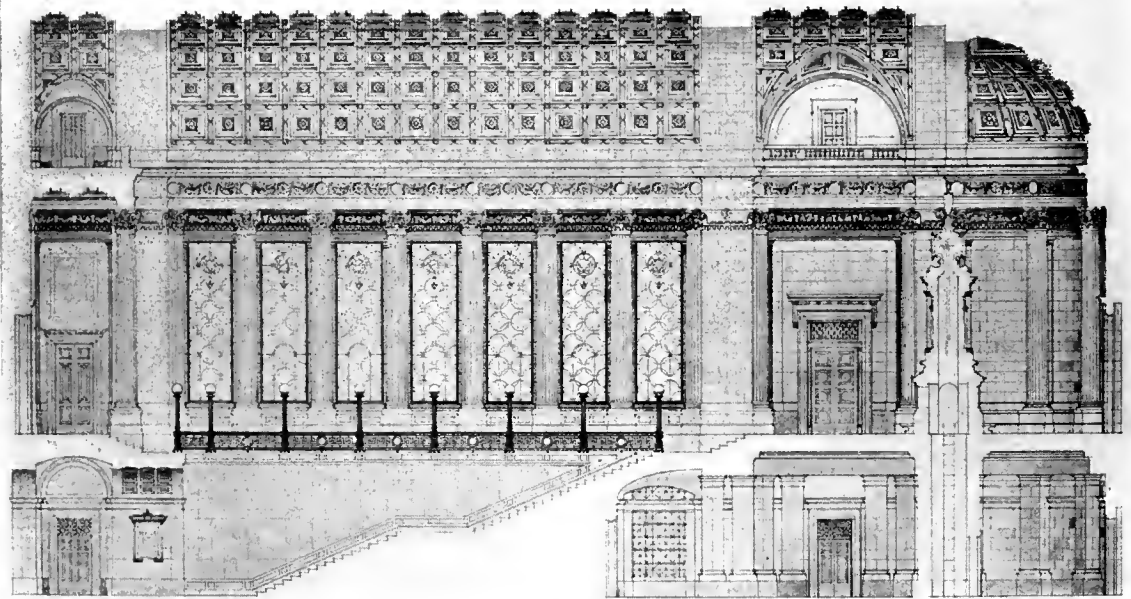
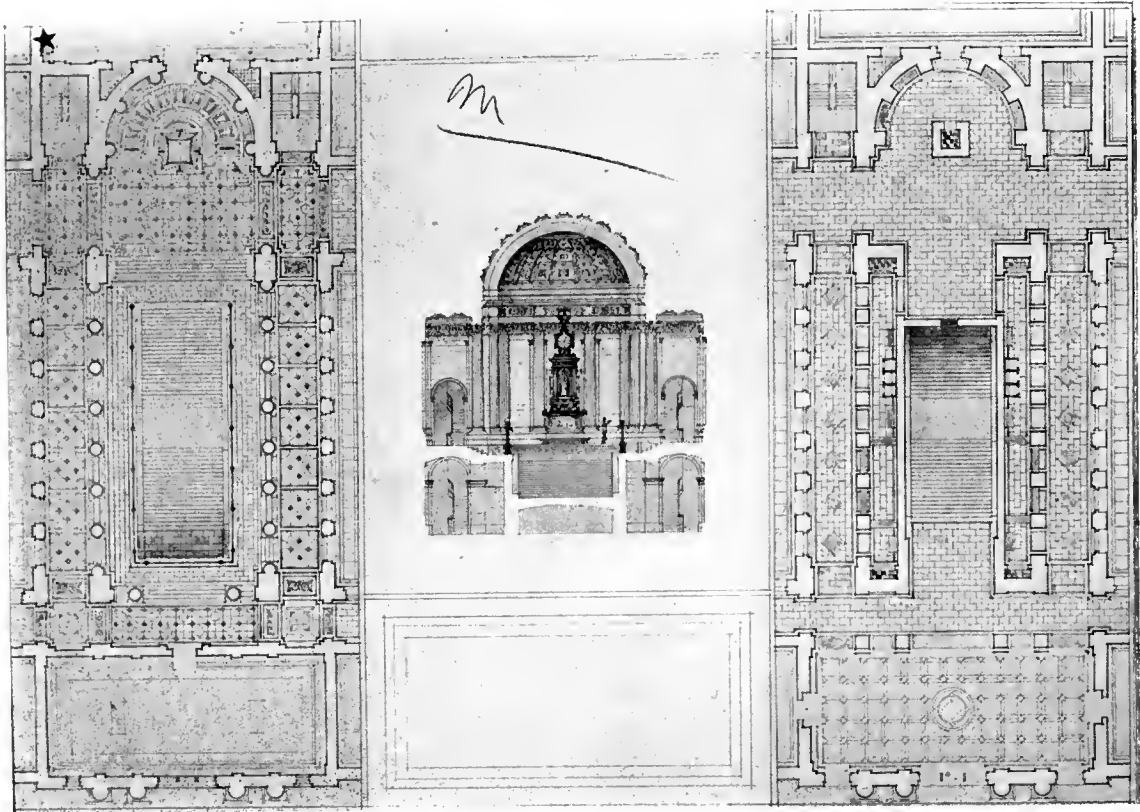

FIRST MEDAL

L. S. LASHMIT

CARNEGIE INSTITUTE OF TECHNOLOGY

CLASS A-II PROJECT. A STAIRCASE HALL

STUDENT WORK, BEAUX-ARTS INSTITUTE OF DESIGN

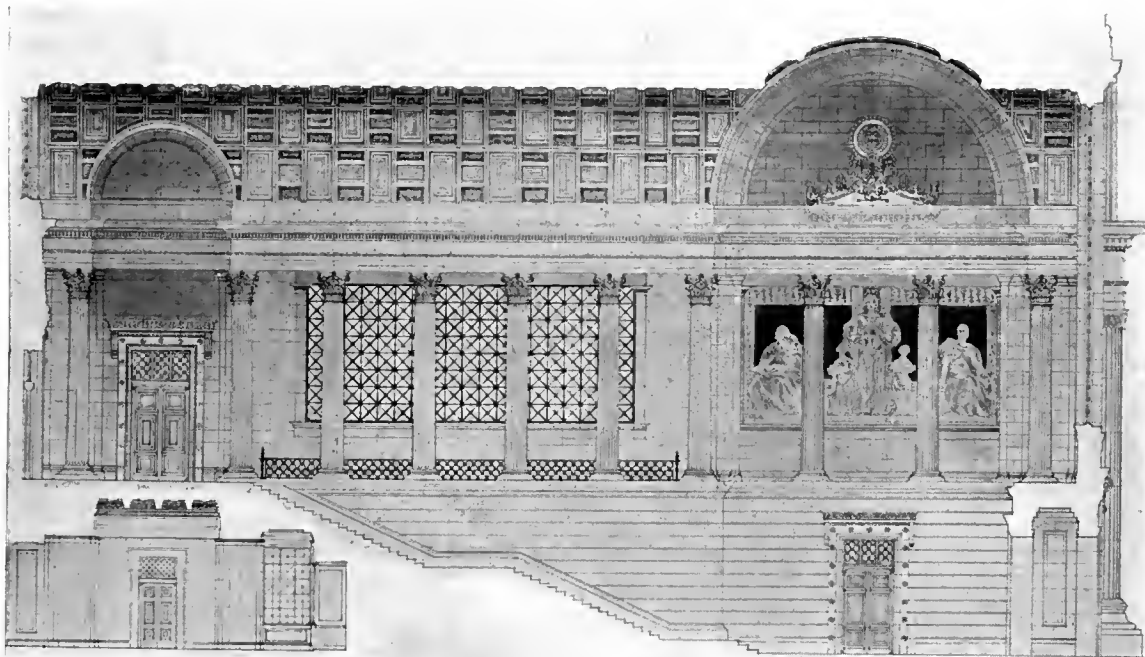
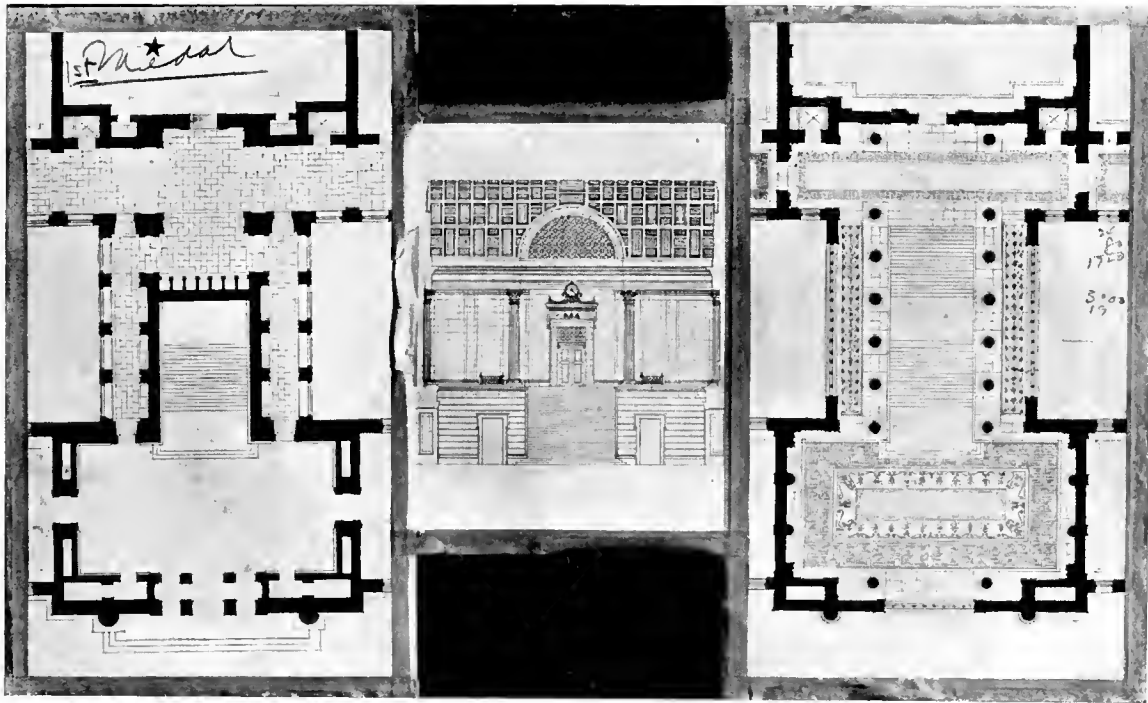

FIRST MEDAL

B. DIERKS

CARNEGIE INSTITUTE OF TECHNOLOGY

CLASS A-H PROJ. A STAIRCASE HALL

STUDENT WORK, BEAUX-ARTS INSTITUTE OF DESIGN



SECTION

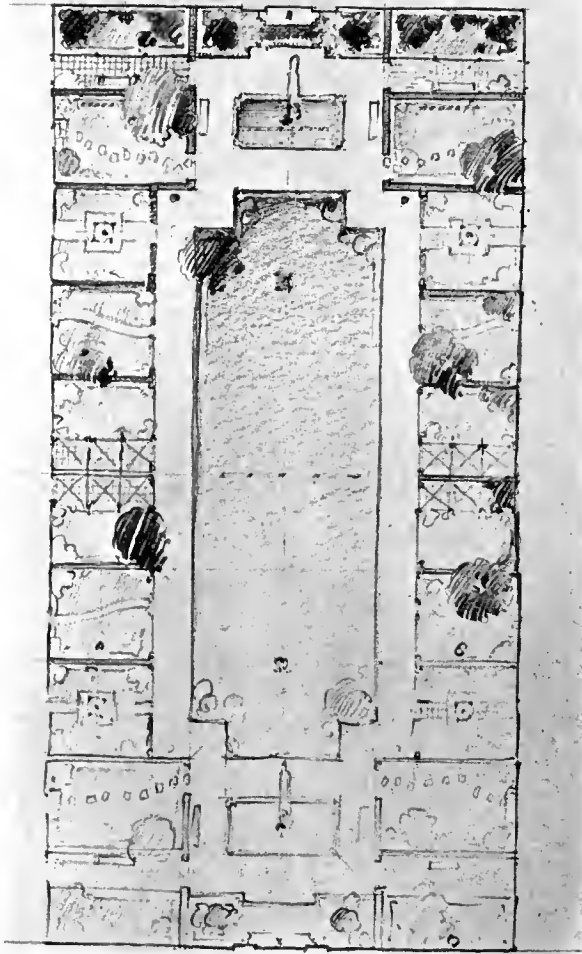

CLASS B-II. ESQUISSE-ESQUISSE
THE DECORATION OF A CITY GARDEN
FIRST MENTION—J. WESTON
Los Angeles Architectural Club

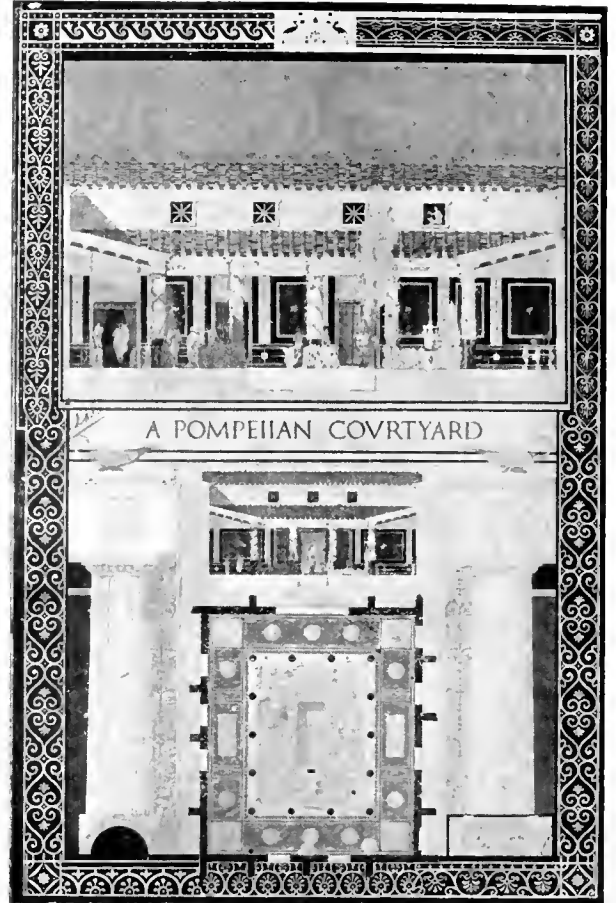

CLASS "A" & "B." ARCHAEOLOGY-II PROJCT
A POMPEIAN COURTYARD
THIRD MEDAL—W. E. VIRRICK
Columbia University

STUDENT WORK,
BEAUX-ARTS INSTITUTE OF DESIGN

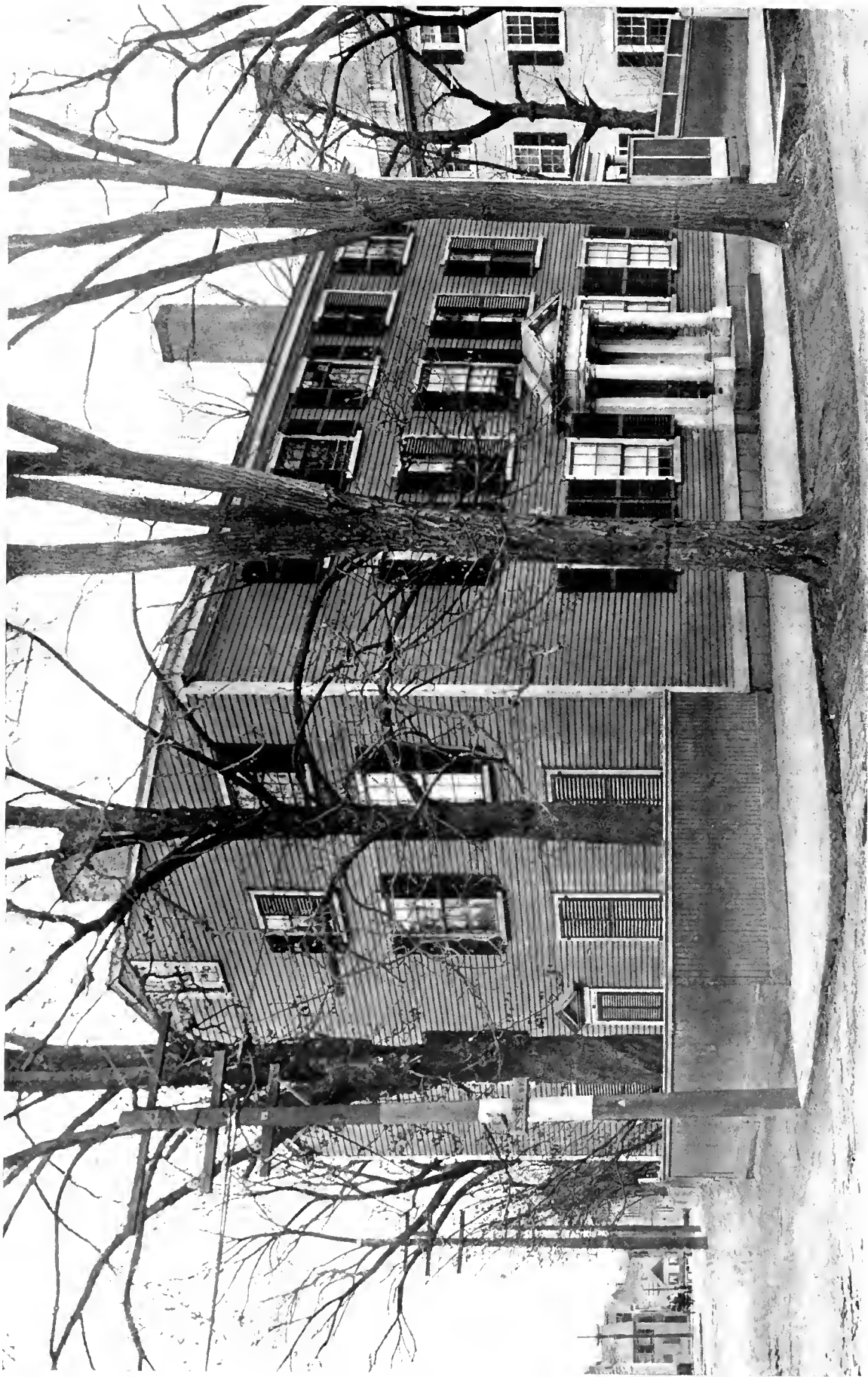

STEARNS HOUSE, ESSEX STREET, SALEM, MASS.
SAMUEL McINTIRE, ARCHITECT



BALDWIN-LYMAN HOUSE, WASHINGTON SQUARE, SALEM, MASS.
SAMUEL McINTIRE, ARCHITECT

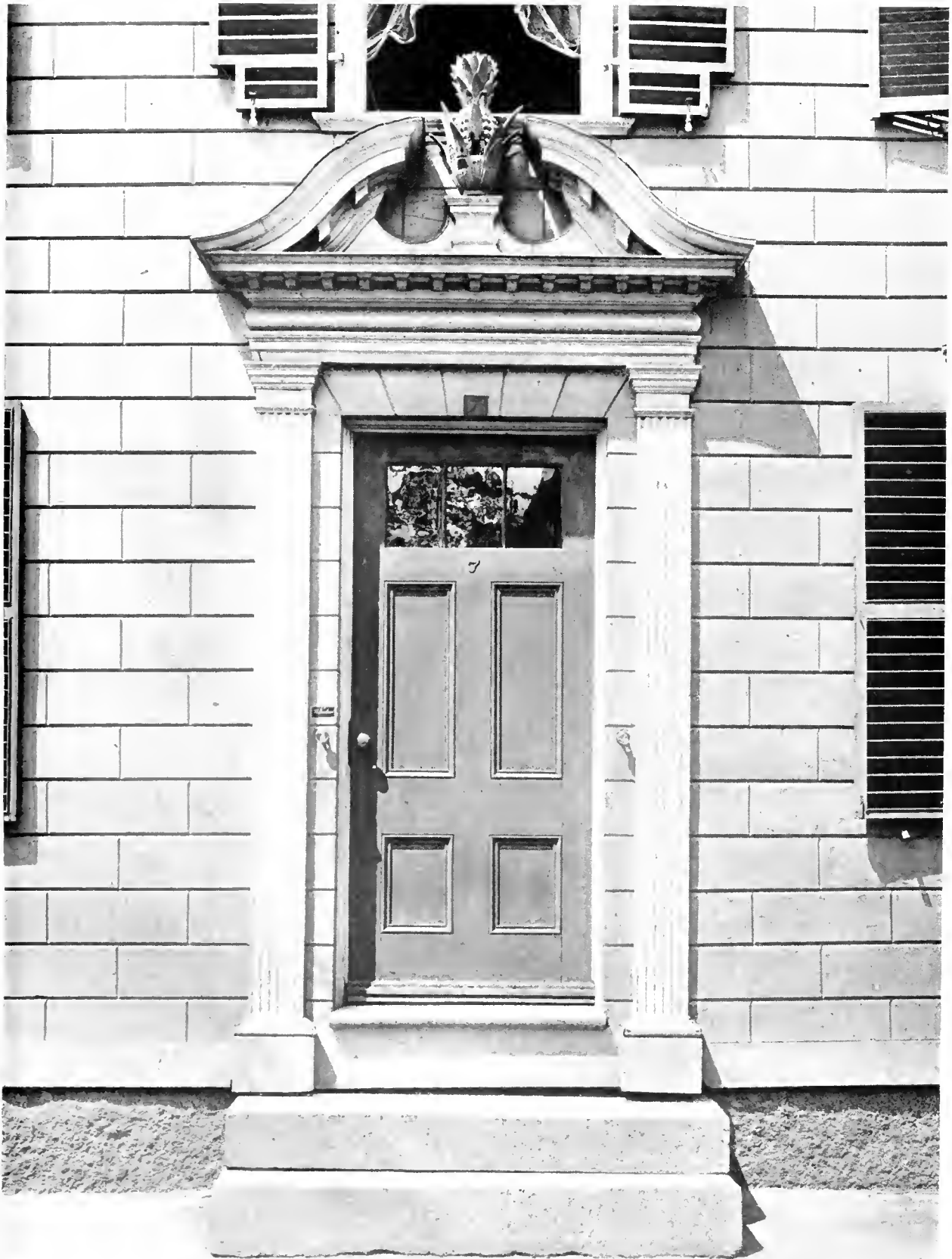

PINEAPPLE DOOR
BROWN STREET, SALEM, MASS.
SAMUEL McINTIRE, ARCHITECT





ENTRANCE DETAIL
FORRESTER-PEABODY-SALEM CLUB, SALEM, MASS.
SAMUEL McINTIRE, ARCHITECT



DOORWAY
CABOT-ENDICOTT-LOW HOUSE, ESSEX STREET, SALEM, MASS.
SAMUEL McINTIRE, ARCHITECT

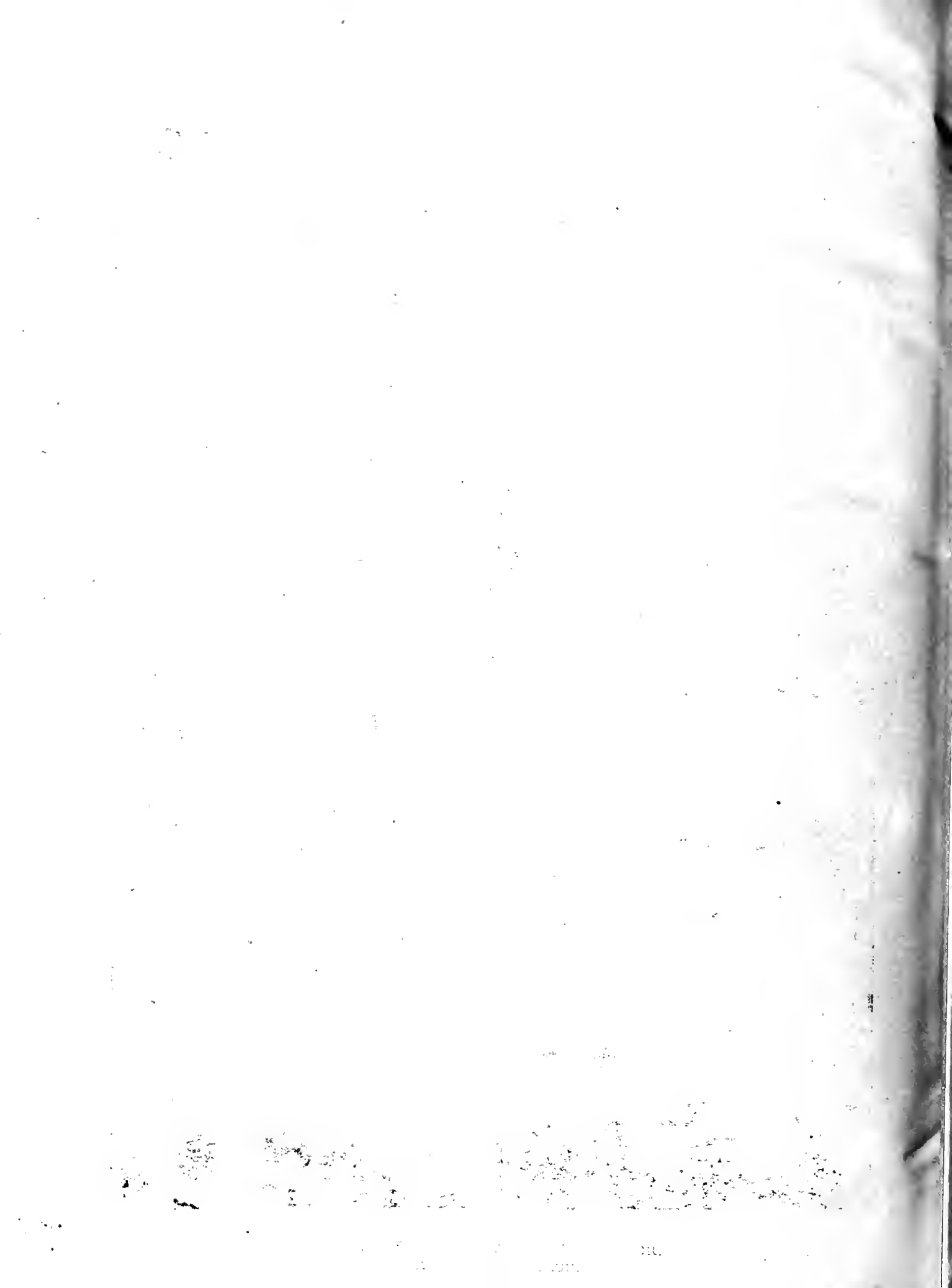

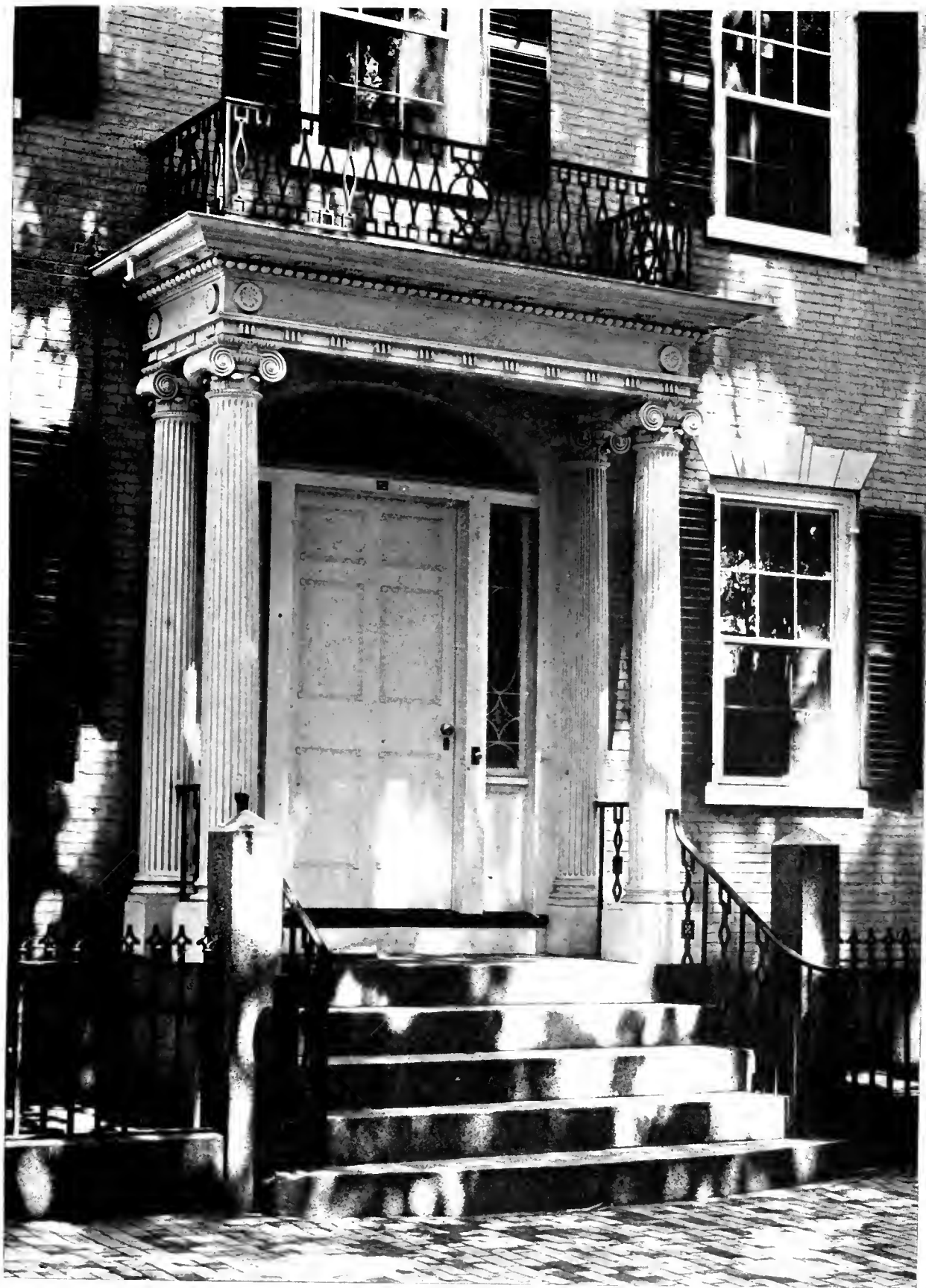

ENTRANCE DETAIL.
PEABODY-SILSBEE HOUSE, ESSEX STREET, SALEM, MASS.
SAMUEL MCINTIRE, ARCHITECT
ERECTED 1797

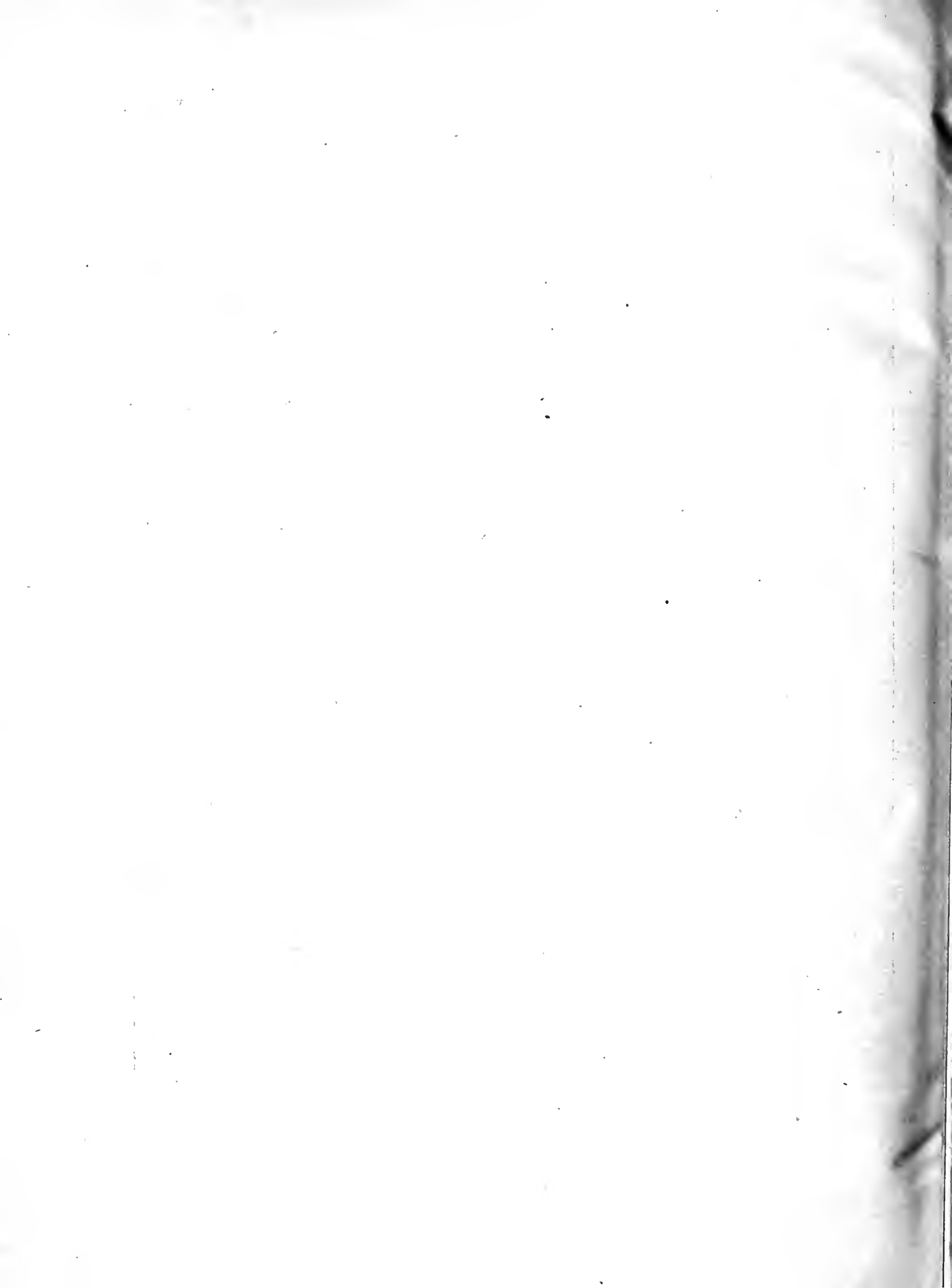

THE AMERICAN ARCHITECT

wholesale alteration reduces the cost of each unit and permits the establishment of a community upon which its surroundings have but little effect.

With this idea in view, a group of people have bought, on two of the side streets of a large city and in the middle of the block, two rows of houses of ten each, facing back to back, with the purpose of remodelling them and laying out the yards into a garden that will be common to all.

The problem is the study of this garden, which will extend the full length of the houses, i. e., 200 feet—and will be 100 feet wide between their rear walls. Individual gardens for each house should be developed within the scheme, care being taken, however, that they are not so emphasized as to destroy the general effect of the garden as a whole. Fountain, pools, loggias or any form of garden decoration may be used, and by some means the view of the neighboring houses on either side should be masked or screened. The houses in the group are three and four stories.

NUMBER OF DRAWINGS SUBMITTED: 38.

AWARDS:

First Mention: F. D. V. Martinelli, Atelier Corbett-Gugler, New York City; J. Weston and E. Weston, Los Angeles A. C., Los Angeles; A. L. Muller, Atelier Wynkoop, New York City.

Mention: C. J. Pellegrini, C. B. Marks and R. E. Dake, Carnegie Institute of Technology, Pittsburgh; W. Conley and A. M. Taylor, Columbia University, New York City; G. M. Musick, Atelier Denver, Denver; G. Chittenden and G. Verge, Los Angeles A. C., Los Angeles; R. E. Dando, Atelier Parsons-Chicago A. C., Chicago.

PROGRAM

CLASS "A" AND "B" ARCHAEOLOGY—II PROJET

The Committee on Architecture proposes as subject of this Competition:

"A POMPEIAN COURT YARD"

In A. D. 79 the flourishing town of Pompeii, one of the pleasure resorts of the Roman aristocracy was overwhelmed by the great eruption of Vesuvius. Buried under a shower of ashes and small stones, which can easily be removed by the archaeologist, it has been preserved as a most perfect relic of antiquity. The weight of the overlying material has destroyed the roofs and second stories of the buildings but the walls of the lower stories are standing and the plans are clearly outlined. We can still walk through the streets with their stone pavement deeply rutted by the chariot wheel, and the numerous private houses still afford an insight into the ordinary life and habits of the population of an ancient town. These houses show a variety of individual taste and imagination, always restrained, however, by the customary arrangement of vestibule, atrium and peristyle. This latter was an open court surrounded by a colonnade, from which were the entrances to the private rooms of the dwelling. These courts were ornamented with pools, fountains, statues and vases grouped in shrubbery and flowers as a miniature garden.

The subject of this program is the design of such a court. The opening to the sky shall not exceed 30 x 40 feet, exclusive of the surrounding colonnade.

NUMBER OF DRAWINGS SUBMITTED: 16.

AWARDS:

Third Medal: W. E. Virrick, L. J. Valker and M. L. Colean, Columbia University, New York City.

Mention: R. V. Murison, R. E. Dake and J. G. Todd, Carnegie Institute of Technology, Pittsburgh; R. L. Minikus, Chicago School of Architecture, Chicago; L. H. Scho-

field and G. S. Johnston, J. Huntington, Polytechnic Institute, Cleveland; W. B. Mylchrest, Syracuse University, Syracuse; R. Gleeson, University of Pennsylvania, Philadelphia; Essie Lipscomb and R. L. White, University of Texas, Austin.

The Southern Intercollegiate Competitions

THE increase in the facilities for architectural education is not generally known. With the rapid development of the country and increased wealth and resources, there must be an increased demand for architectural service. This demand is also made more insistent by the intricate and complex problems that are brought about by the important changes made in the methods of building construction. It is well that the sources of architectural training be distributed throughout the country for on that is based the hope and expectation of there being developed a truly representative American type of architecture.

The annual Southern Intercollegiate Competitions are contested by a group of southern architectural schools which are departments of the Alabama Polytechnic Institute, Tulane University, Agricultural and Mechanical College of Texas, Rice Institute of Texas, the Agricultural and Mechanical College of North Carolina (generally known as Clemson College) and The Georgia School of Technology. At least four of the six schools have entered into each annual competition. The entries have been limited to four or five designs from each school. The competitors are limited to members of the senior class and the problems are of six weeks' duration. The programs have been written and problems judged by the architectural faculties of the University of Pennsylvania, Massachusetts Institute of Technology, Cornell University, Columbia University and the Carnegie Institute of Technology.

These competitions have had a very fine effect on the spirit and mark of the students and have always brought out the best efforts of the men. After the awards are made the drawings are exhibited at the competing schools. The Georgia School of Technology seems to win with great regularity, which should be very pleasing to Mr. Francis P. Smith, Professor of Architecture.

The first prize designs for the years 1917-1920 are here illustrated and indicate the character of the work accomplished at these schools. They compare very favorably with the work done at schools located in other sections of the country.

THE AMERICAN ARCHITECT

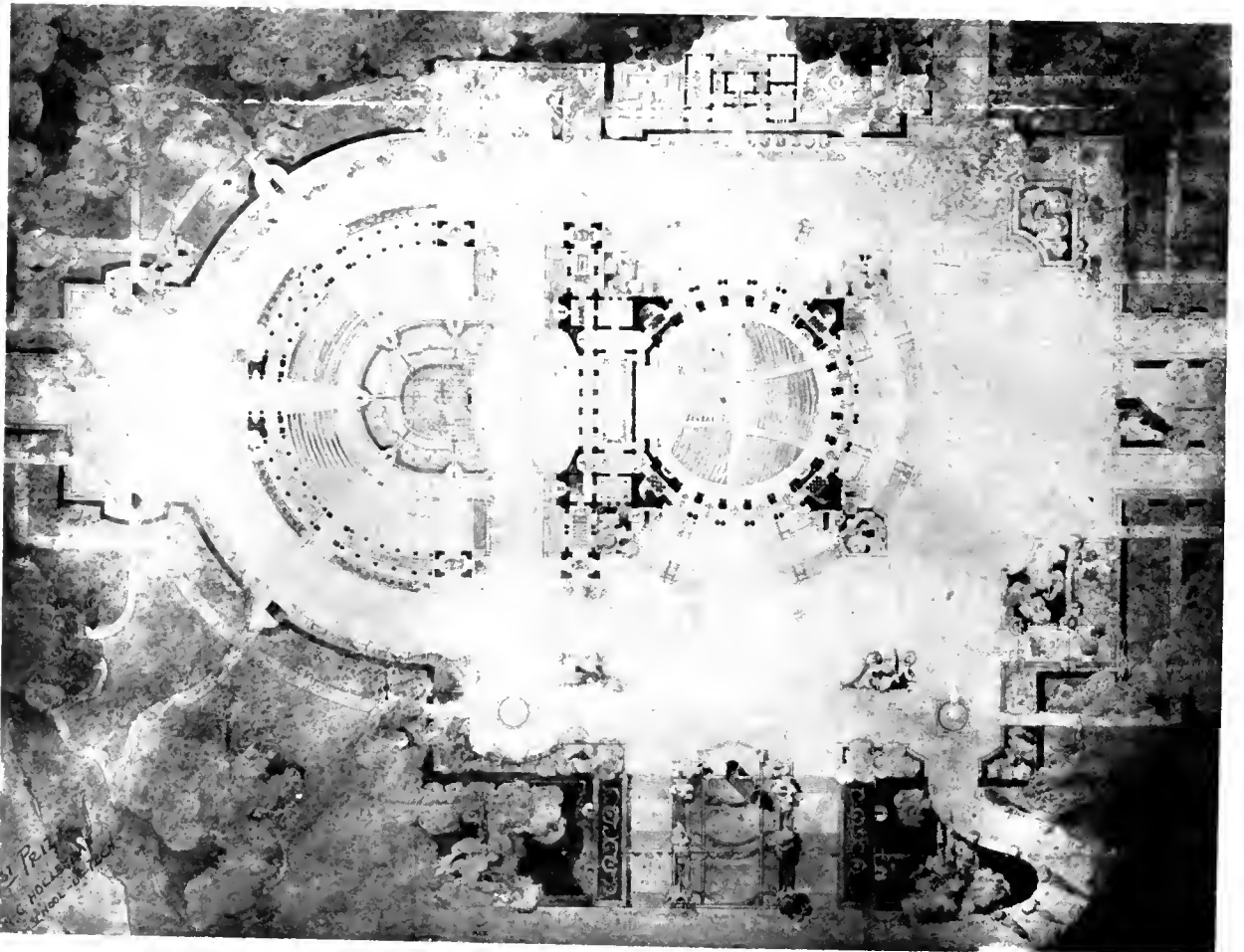
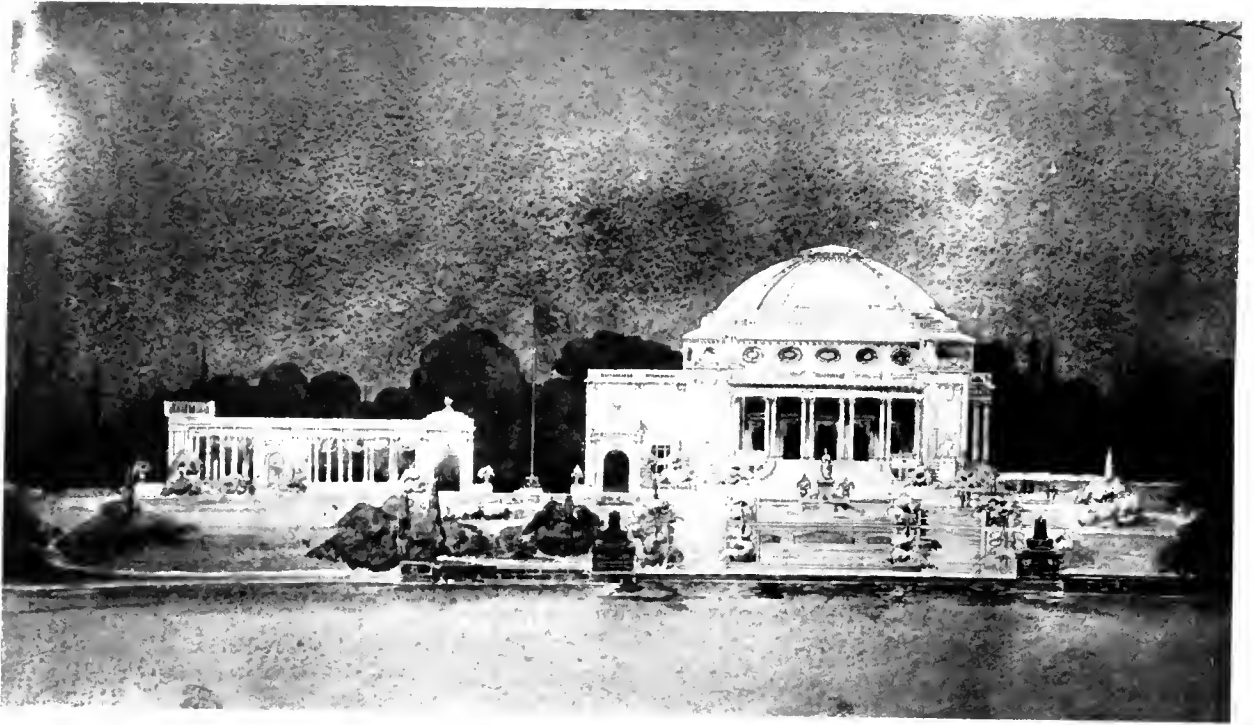

W. C. HOLLEYMAN

FIRST PRIZE

GEORGIA SCHOOL OF TECHNOLOGY

A NATIONAL FORUM OF MUSIC
SOUTHERN INTERCOLLEGIATE ARCHITECTURAL COMPETITION

THE AMERICAN ARCHITECT

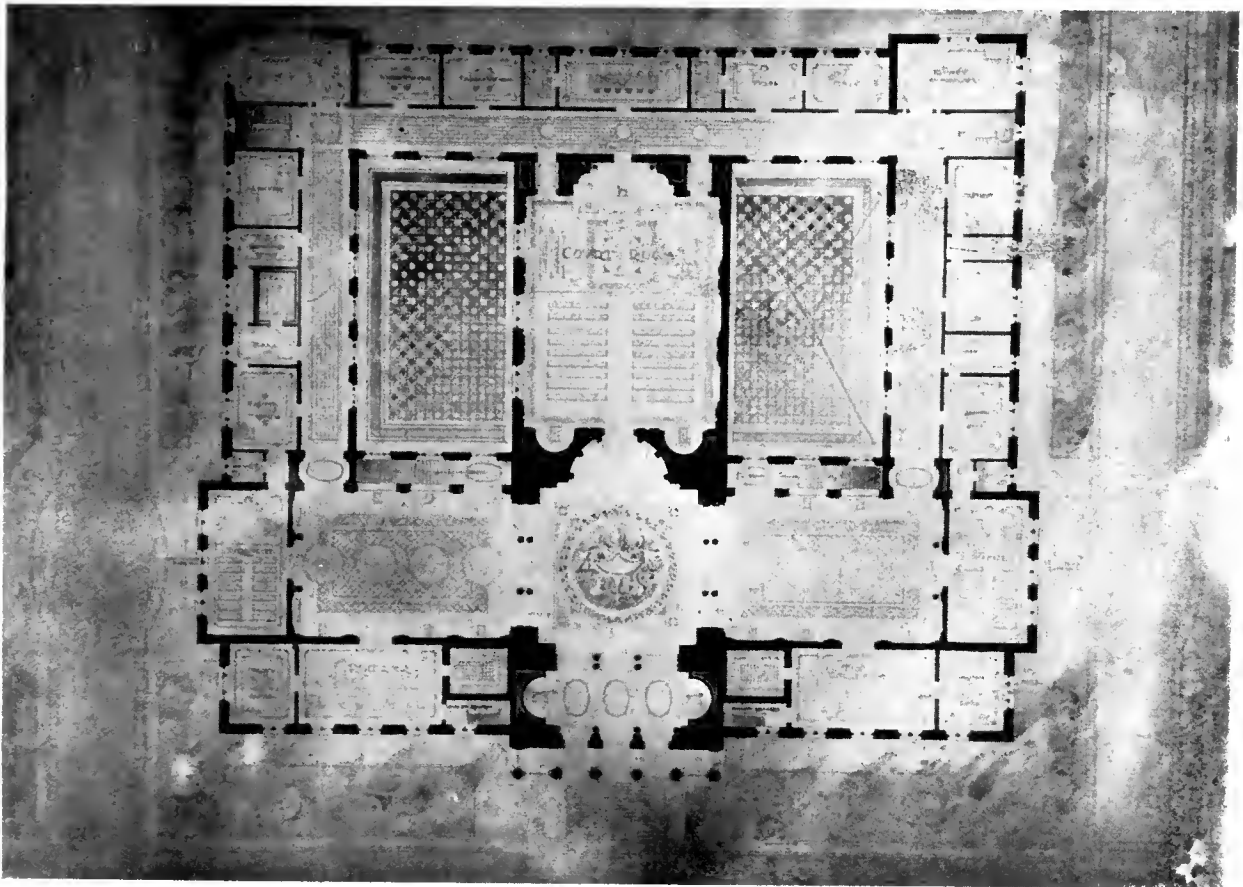
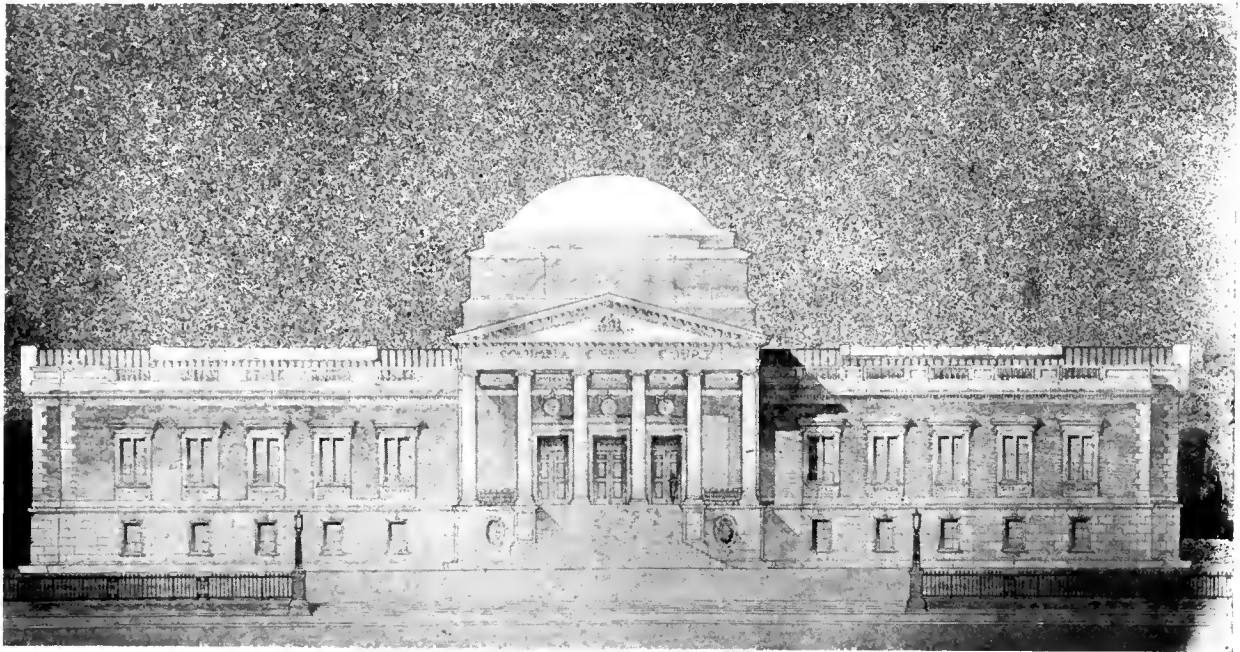

H. I. HIRSCH

FIRST PRIZE

GEORGIA SCHOOL OF TECHNOLOGY

A COUNTY COURT HOUSE

SOUTHERN INTERCOLLEGIATE ARCHITECTURAL COMPETITION

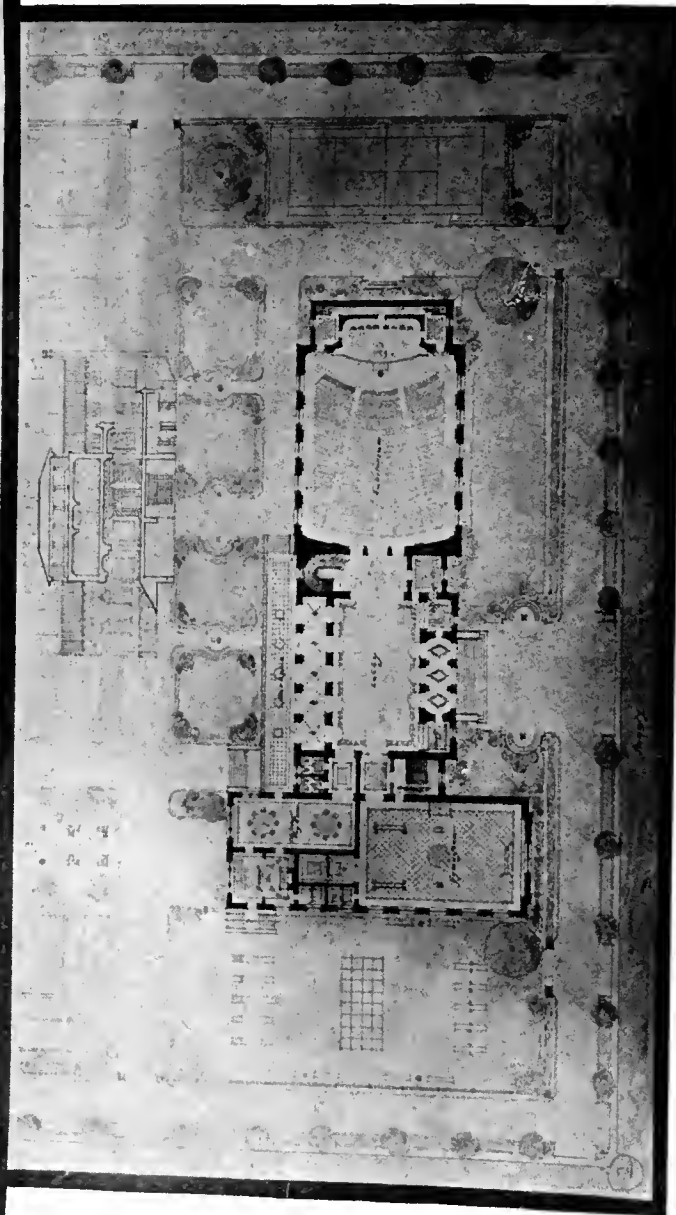
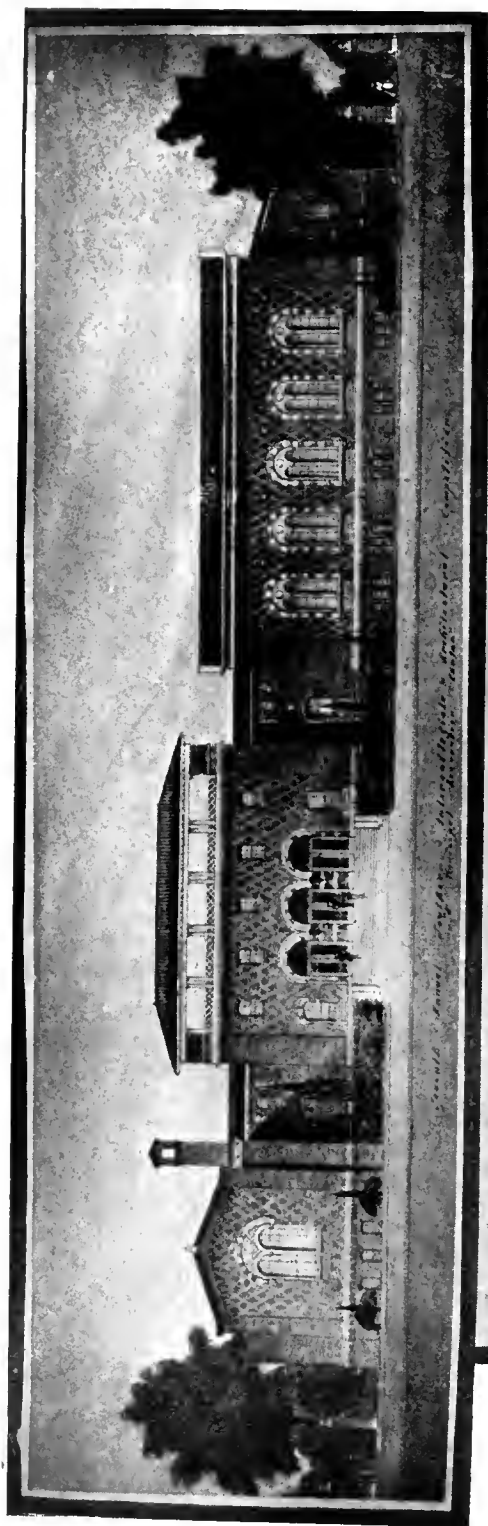

G. W. RAMEY

FIRST PRIZE
A COMMUNITY RECREATION CENTER
SOUTHERN INTERCOLLEGIATE ARCHITECTURAL COMPETITION
GEORGIA SCHOOL OF TECHNOLOGY

THE AMERICAN ARCHITECT

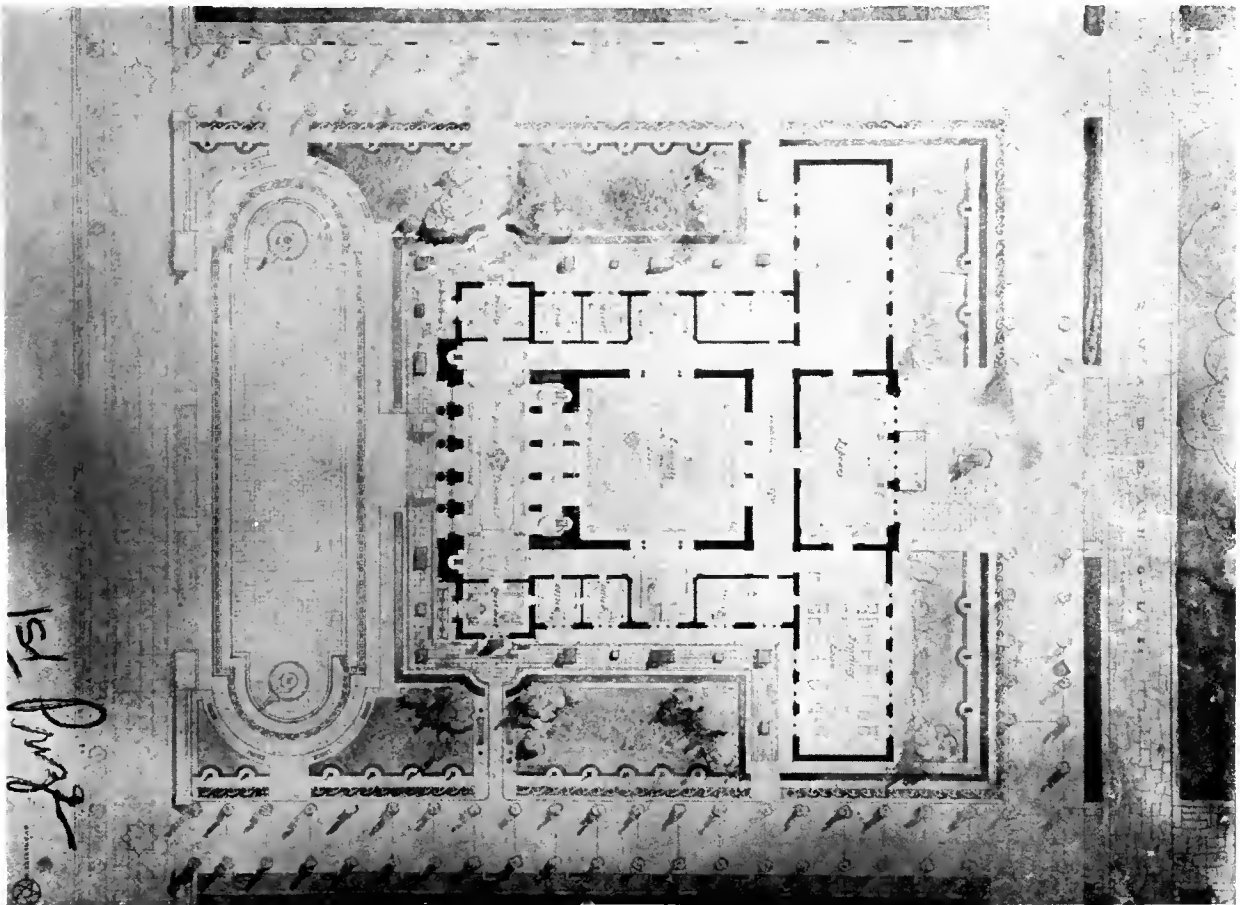
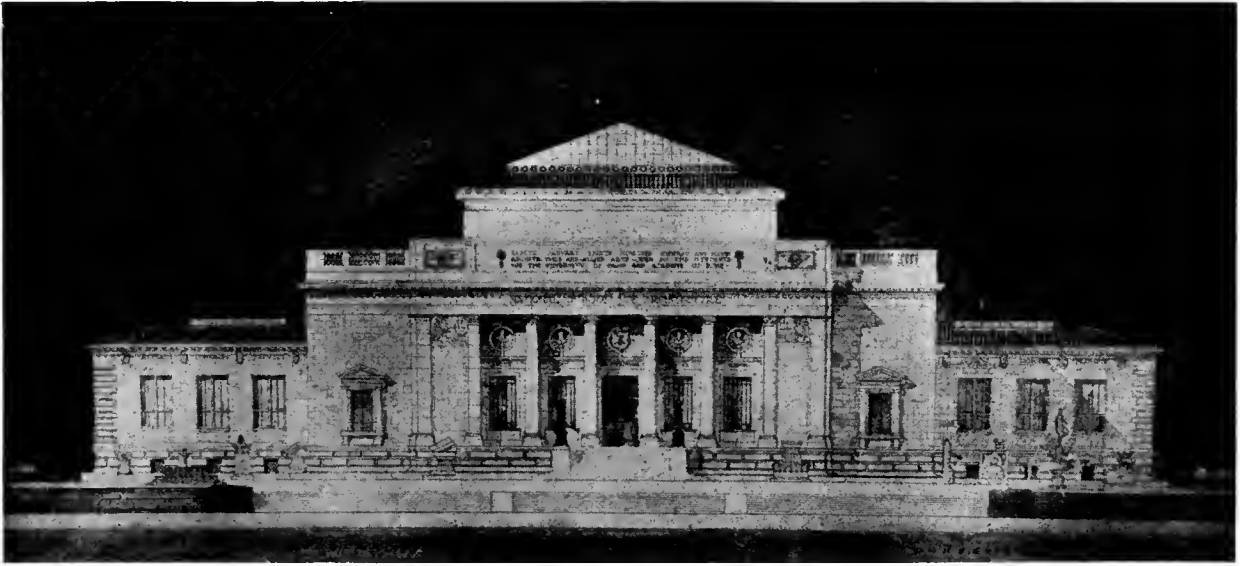

E. W. BEACHEM

FIRST PRIZE

GEORGIA SCHOOL OF TECHNOLOGY

A NATIONAL FORUM OF MUSIC
SOUTHERN INTERCOLLEGIATE ARCHITECTURAL COMPETITION

DEPARTMENT OF ARCHITECTURAL ENGINEERING

Refrigeration—Part I.

By CHARLES L. HUBBARD

THE extensive use of refrigeration in a great variety of industries makes it a matter of especial interest to architects. While the design and installation of refrigerating equipment for large cold storage warehouses, packing plants, etc., are usually carried out under the direction of an expert, the so-called "portable" plant is commonly taken care of by the architect himself.

Recent data covering a period of two or three years shows that nearly 80 per cent. of the refrigerating installations made during that time have been of small size, averaging about 10 tons' capacity each, and applied to miscellaneous purposes, such as apartment houses, bakeries, clubs, confectioner's shops, creameries and dairies, department stores, fish markets, grocery and general stores, hospitals, hotels, ice cream manufactories, meat markets, office buildings, railroad stations, restaurants, schools and residences. More than 150 different uses for refrigeration have been enumerated, which should give it much the same importance as heating, ventilating, lighting and plumbing in connection with certain classes of building construction. Complete machines are built in all sizes, ranging from those adapted to private residences up to units suitable for the largest hotels. Most of the smaller outfits are mounted, complete, upon a single base, ready for connection with the refrigerator. In case of the larger sizes the condensing and cooling pipes are frequently hung upon an adjacent wall or supported upon separate foundations. The general equipment for all capacities is comparatively simple, and varies only in size, so far as the essential parts are concerned. Details, of course, become more complicated with increase in size.

PRINCIPLES OF REFRIGERATION

The cooling effect of any system of refrigeration

depends upon the latent heat of vaporization of the refrigerant or medium employed. When a pound of water is vaporized or changed into steam at atmospheric pressure, 970 thermal units (T.U.) are withdrawn from the surrounding medium, which may be either air or water, depending upon existing conditions. As this action must take place at a temperature of 212 degrees, water is evidently not adapted to purposes of refrigeration, although it is made use of in one type of machine, under special conditions, as described later.

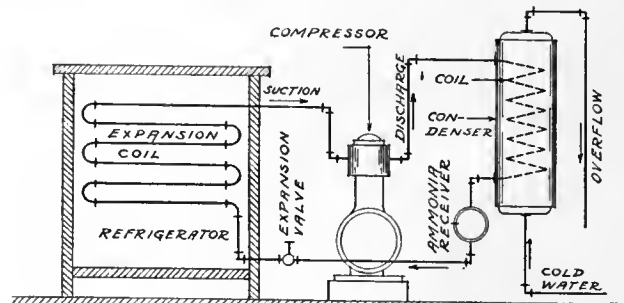

FIG. 1

Anhydrous ammonia, however, boils at a temperature of 29 degrees below zero, under atmospheric pressure, and absorbs 589 T.U. for each pound of liquid evaporated. This medium is more widely used than any other for general refrigerating work, although there are other volatile liquids which have similar properties. The principal objection to the use of ammonia for this purpose is the intensely irritating character of the gas, making a leak in an enclosed space extremely difficult, and in some cases, dangerous to deal with. Conditions of this kind are especially common on shipboard, where the space available for refrigerating machinery is usually cramped and poorly ventilated, and this has resulted

THE AMERICAN ARCHITECT

in the substitution of other refrigerating mediums for marine work, of which carbonic anhydride, or carbonic acid, is the most widely used. A machine employing a salt solution has been used to a considerable extent on naval vessels, and certain forms of this are especially adapted to air cooling, and drinking water outfits, where low temperatures are not necessary. Developments involving the use of dense or liquid air have been under way for some

are the "compression" and "absorption" systems, together with certain modifications and combinations of the same. Points to be considered in the selection of a system will best be understood after a brief description of these.

COMPRESSION SYSTEM

The essential parts of this system are shown in Fig. 1, and consist of a power-driven compressor, a

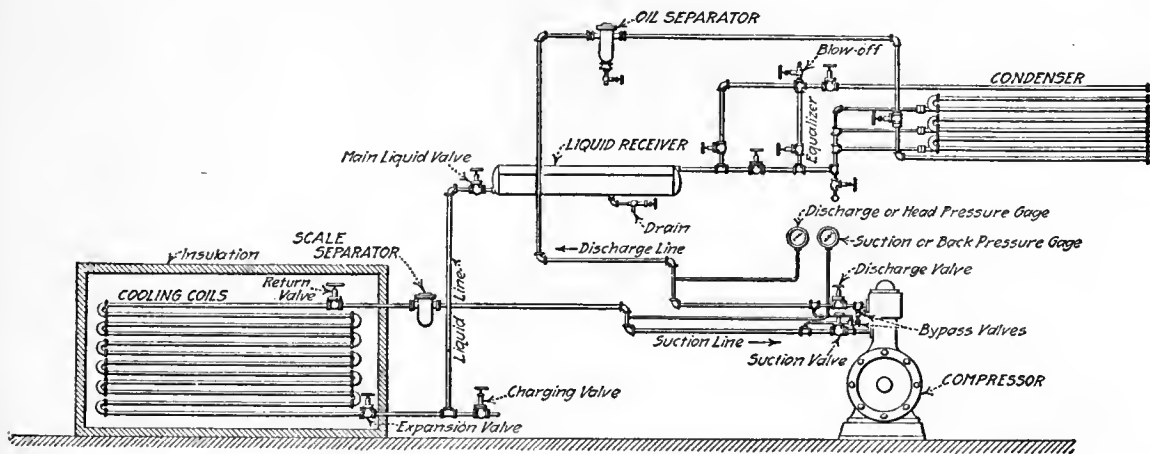

FIG. 2

time, and machines of this type were installed upon a few naval vessels during the war, but at the present time the expense of this equipment is too great for general refrigerating purposes. Ammonia machines are almost universally installed for ordinary private and commercial work, where there is ample ventilation in case of escaping gas.

SYSTEMS OF REFRIGERATION

The systems of refrigeration in most common use

submerged coil or condenser, an ammonia receiver, an expansion valve, and an expansion coil in the refrigerator or space to be cooled. For purposes of illustration let us start with liquid ammonia in the receiver under a high pressure. By opening the expansion valve slightly, a small amount of this liquid passes into the expansion coil, where it soon vaporizes, due to the lower existing pressure, and during this process extracts the necessary latent heat of

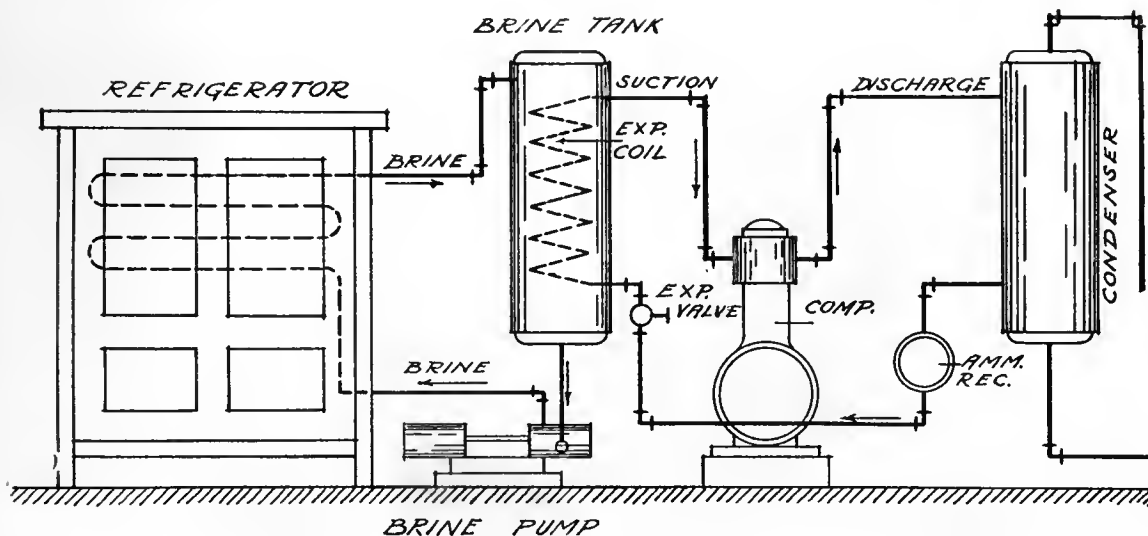

FIG. 3

vaporization from the air surrounding the coil, thus lowering its temperature.

The compressor, being in operation, draws the low-pressure gas from the expansion coil into the cylinder, where it is compressed to a high pressure and delivered as a gas to the condensing coil, which, being submerged in cold running water, absorbs the latent heat and again reduces the gas to a liquid, which flows into the receiver and thus completes the cycle. The pressure carried in the condensing and expansion coils (high-pressure and low-pressure sides of the machine) will vary somewhat, depending upon the size of plant and operating conditions, and

the most part, are clearly indicated by notes on the drawing, but attention should be called to the form of condenser, which is radically different from that shown in Fig. 1. Instead of submerging the expansion coil in a tank of water, a double tube is used, with water flowing through the inner one. This will be described in detail later.

In the arrangements thus far shown, the coil in which the vaporization of the ammonia takes place is located in the refrigerator, or space to be cooled, so that the latent heat is drawn directly from the surrounding air. Plants designed in this manner operate on what is known as the *direct* system. In

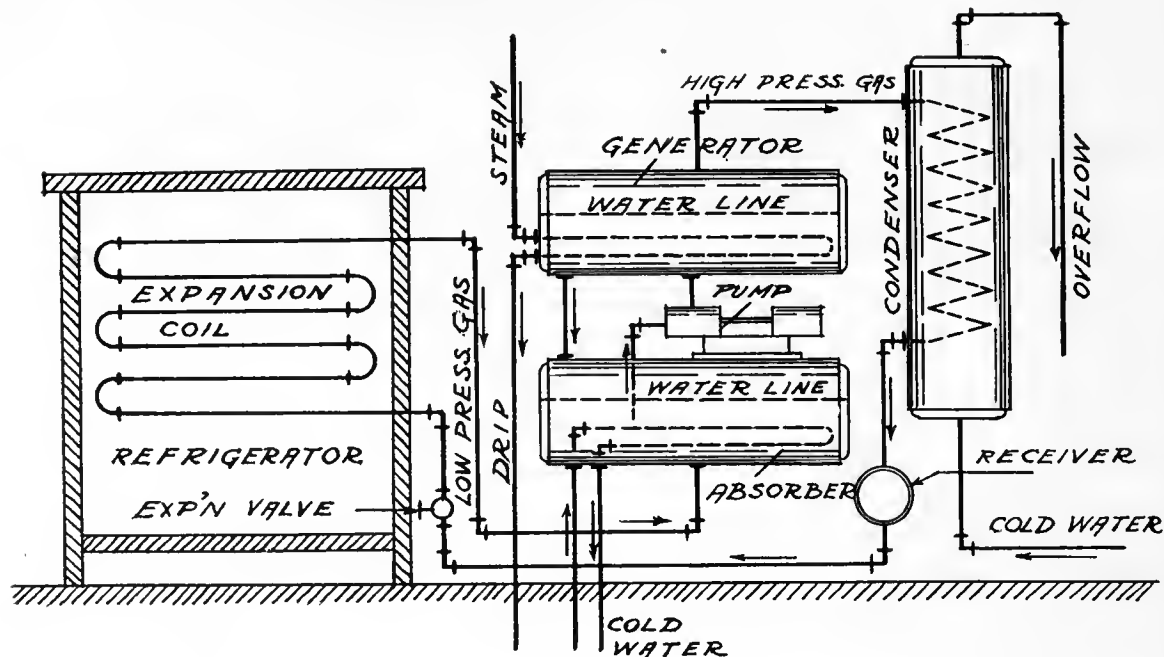

FIG. 4

may be taken as 125 to 250 and 15 to 30 pounds per square inch, respectively. The statement is sometimes made that under average conditions, with condensing water purchased at city rates, the most economical results will be secured with a suction pressure of about 25 pounds and a condenser pressure of 150 pounds. These, however, are matters of detail which are usually settled by the builders.

While the working range, with ammonia as a medium, may be taken as 15 to 250 pounds, carbonic anhydride requires much higher pressures on both the high and low pressure sides of the machine, and for average conditions a working range of 300 to 1,200 pounds per square inch may be taken. In some cases, as in marine work, pressures considerably higher are often employed. Fig. 2 shows a compression plant in more practical form, and introduces certain details not included in Fig. 1. These, for

the *brine* system, shown in Fig. 3, the expansion coil is placed in a tank of brine, and the latter, after being cooled to a low temperature, is pumped through a secondary coil in the refrigerator. This arrangement has its advantages under certain conditions and is used in connection with both the compression and absorption systems.

ABSORPTION SYSTEM

The principle upon which this system operates is illustrated in Fig. 4, and is identical with that shown in Fig. 1, except the compressor has been replaced by an *absorber*, a small *ammonia pump*, and a *generator*. In operation the low-pressure gas passes from the expansion coil to the absorber, where it is taken up by water cooled by a coil of pipe through which cold water, from an outside source, flows continuously. This solution of ammonia, which is formed

THE AMERICAN ARCHITECT

in the absorber, is called "strong liquor," and is pumped into the generator above, as indicated.

The generator contains a steam coil, which heats the liquor and drives off the ammonia gas under a high pressure to the condenser in the same manner

the residue is called "weak liquor," and being under a higher pressure than the absorber, flows back through a pipe connection shown at the left of the pump.

Absorption systems are constructed in a variety

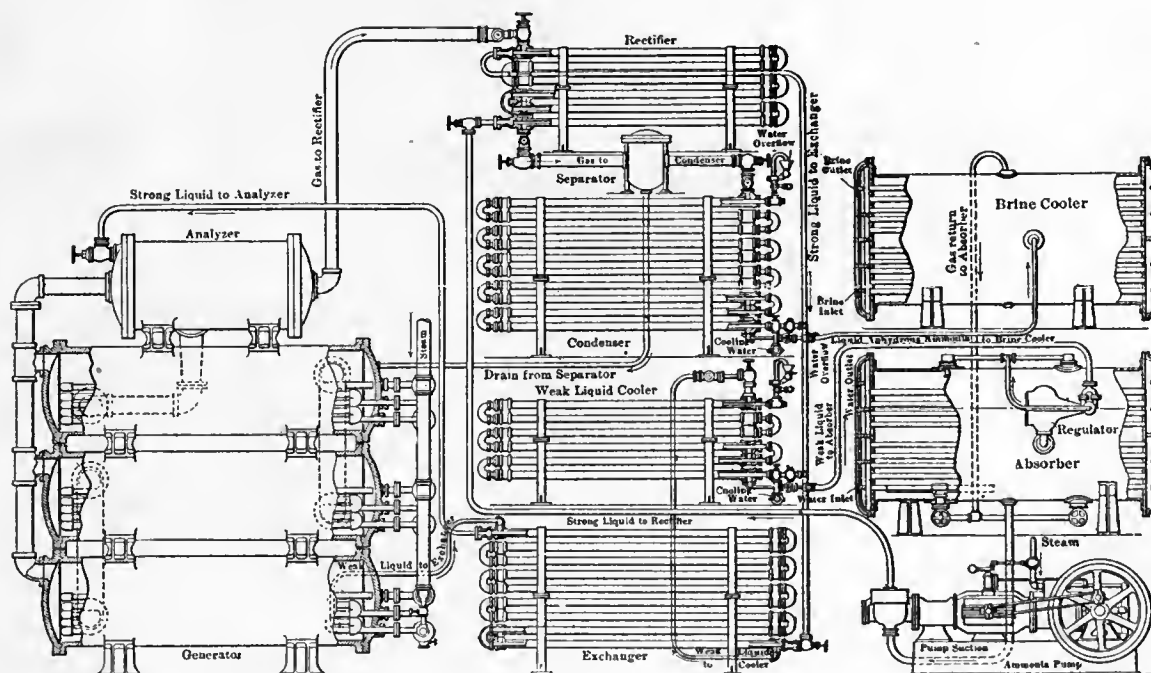

FIG. 5

as it is discharged by the compressor in a compression system. From here on, the process is identical with that shown in Fig. 1 until the low-pressure gas again passes into the absorber. After the ammonia has been driven off from the solution in the generator

of forms, and the practical application of this principle makes use of various auxiliary equipment, certain parts of which are shown in Fig. 5. The generator in this case consists of three units or sections, mounted one above the other in order to save floor

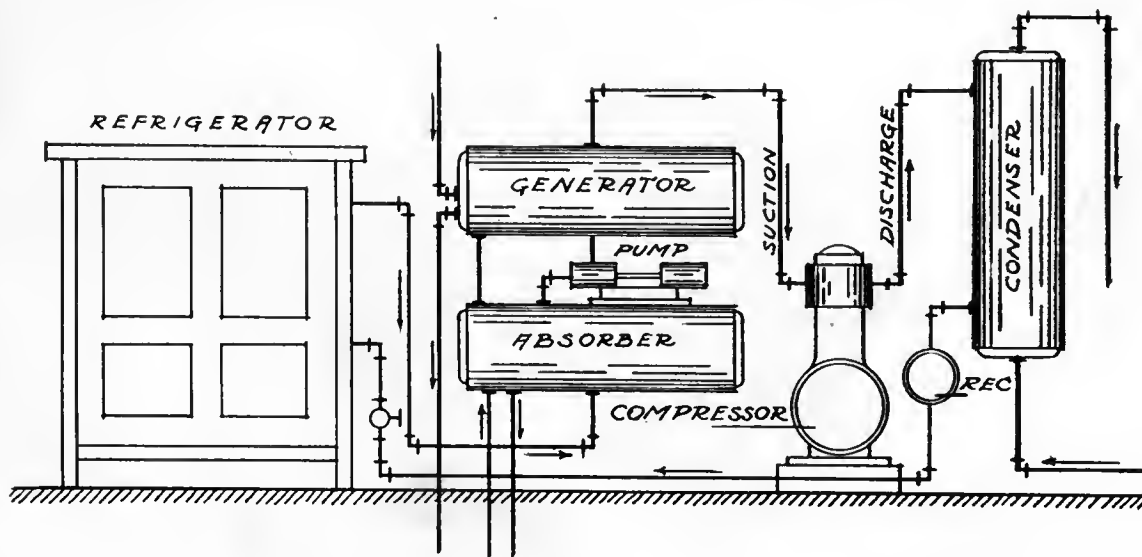

FIG. 6

THE AMERICAN ARCHITECT

space. The condenser is of the double-tube pattern, already mentioned.

The *rectifier*, *weak liquor cooler* and *exchanger* are similar in construction to the condenser, and their uses will be described later. The absorber and brine cooler are of the tubular form with outer shell, although the double-tube construction is often used for these in certain cases.

COMBINED COMPRESSION AND ABSORPTION SYSTEMS

The arrangement for this combination is shown in Fig. 6, and should be studied in connection with Figs. 1 and 4. It consists simply in introducing a compressor in the line between the generator and condenser, as indicated. Low-pressure gas from the expansion coil in the refrigerator enters the absorber, mixes with the cool weak liquor, forming strong

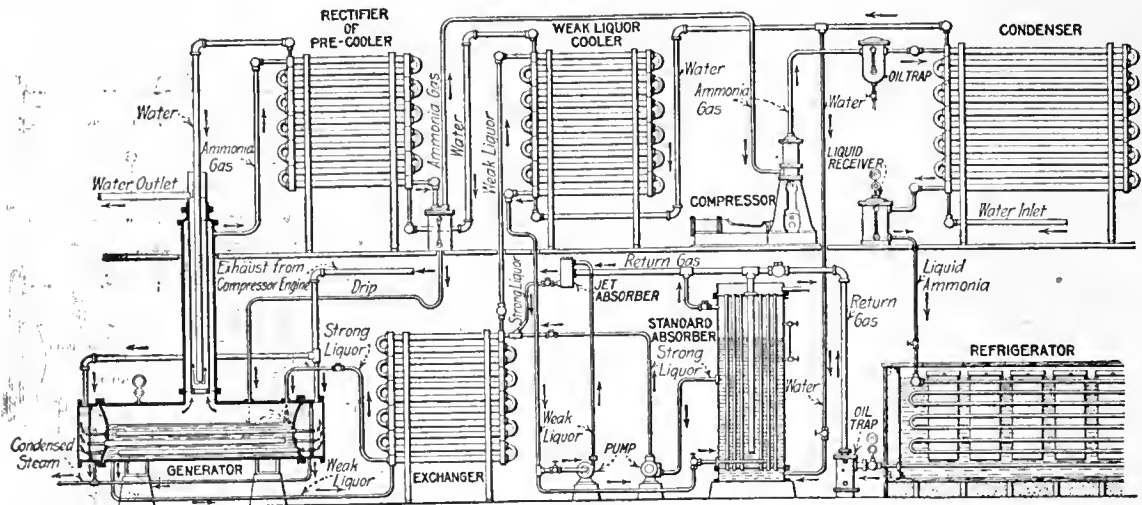

FIG. 7

Referring to Fig. 5, let us first trace the ammonia in both its gaseous and liquid form through the system, and then take up the use of the auxiliary equipment not shown in Fig. 4. Low-pressure gas from the expansion coil in the brine cooler flows into the absorber, as indicated, and mixes with the water, forming "strong liquor" which is at a fairly low temperature due to the circulation of cold water through the tubes. This is pumped in turn through the rectifier and exchanger to the generator by way of the analyzer. The gas liberated by the heat in the generator passes out through the analyzer to the rectifier, where any moisture which it contains is condensed by contact with the inner pipes through which the cool strong liquor is flowing. From here the dry gas passes into the condenser, where it is liquified, and then admitted to the expansion coil in the usual manner thus completing the cycle. The action of the rectifier has already been described. The exchanger brings the cold strong liquor and the hot weak liquor into contact, thus warming the former before it enters the generator and cooling the latter on its way to the absorber, conditions necessary to the efficient operation of the machine. The weak liquor is still further cooled before entering the absorber by passing it through the cooler located just above the exchanger, where it comes in contact with the cold water flowing through the outer pipes of the coil.

liquor, and is then pumped into the generator, where it is heated by a steam coil. The gas thus liberated is drawn into the compressor and discharged into the condenser under a high pressure. Condensation and

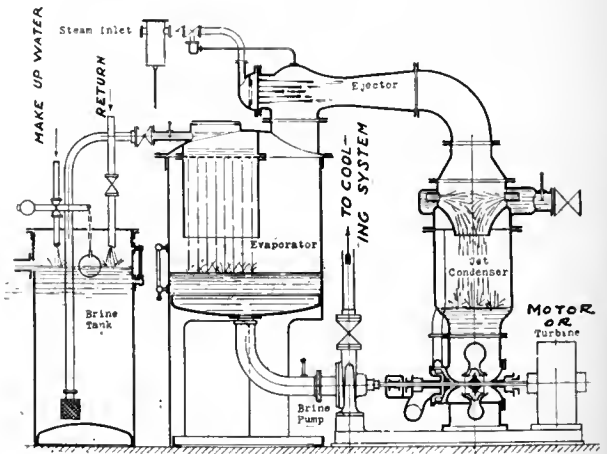

FIG. 8

the admission of liquor ammonia to the expansion coil are the same as in the compression and absorption systems already described. A practical application of the combination system is shown in Fig. 7, which may be examined in connection with Fig. 5. The principal change in this system, as compared with Fig. 5, is the introduction of a jet absorber in

addition to the standard tubular type. The former does the main part of the work, while any gas not absorbed passes automatically into the latter, where it is taken care of and the liquor pumped into the generator, as indicated.

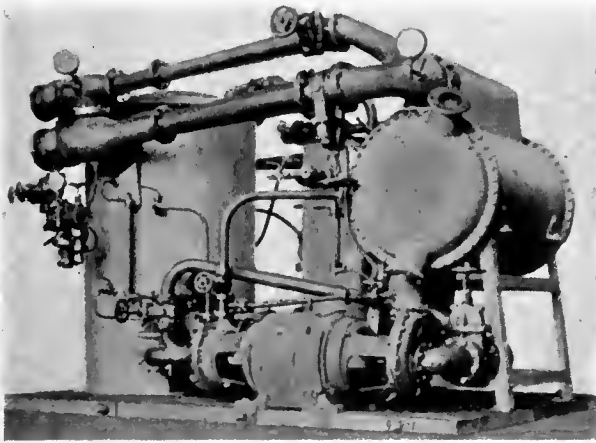

FIG. 9

OTHER SYSTEMS OF REFRIGERATION

The machine illustrated in Fig. 8 makes use of water as the working medium instead of ammonia or carbonic acid. For temperatures above 35 deg., as in air conditioning and the cooling of drinking water, water alone is used as the refrigerant, while for lower temperatures it is necessary to employ brine to prevent freezing. It has already been noted that water exposed to atmospheric pressure (14.7 pounds per square inch, absolute) will vaporize at a temperature of 212 deg. If the pressure is reduced to 0.147 pounds, vaporization will take place at 45 deg., and with 0.087 pounds, at 32 deg., and so on. As latent heat must be supplied to change water into vapor, it is evident that if this cannot be obtained from any other source it will be drawn from the water itself, thus lowering its temperature. Hence, in order to produce any given low temperature of water in an insulated vessel it is only necessary to maintain an absolute pressure corresponding to the vapor tension of the water at the desired temperature (0.087 pounds per square inch for 32 deg.) and remove the vapor as fast as formed.

This is the principle of the machine illustrated in Fig. 8, in which a high vacuum is maintained in the evaporator by means of a steam ejector supplemented by a jet condenser. The entering water or brine from the brine tank is broken into a fine spray which accelerates evaporation, and the vapor thus formed, and any inleaking air, are removed by the ejector and discharged into the condenser, which is equipped

with the usual air and circulating pumps. The cold water or brine which collects in the bottom of the evaporator is pumped through coils in the space or liquid to be cooled, the same as in other systems, and returned to the brine tank.

The machine illustrated in Fig. 8 is for temperatures above the freezing point. For cold storage and ice making the temperature of the brine needs to be considerably lower and a second ejector is added to reduce the pressure in the evaporator to a lower point; otherwise the construction is practically the same. Fig. 9 shows a machine of this type equipped with a surface condenser.

The outfit illustrated in Fig. 10, while operating on the compression principle, is so radically different in design from the ordinary type of machine that it is included under the present heading. This device consists of a revolving shaft carrying two drums, one of which contains a compressor while the other corresponds to an expansion coil. Before leaving the shop the air is exhausted from the first of these, and it is charged with the refrigerant, sulphur dioxide being used in this case; a pure neutral lubricating oil is then added, after which it is hermetically sealed. In operation the drum carrying the compressor revolves in a tank of flowing water, which acts as a condenser, while the drum in which expansion takes place is partially submerged in a brine tank. The small pump for circulating the cold brine through the coils in the refrigerator is shown at the extreme left in the cut. This machine is

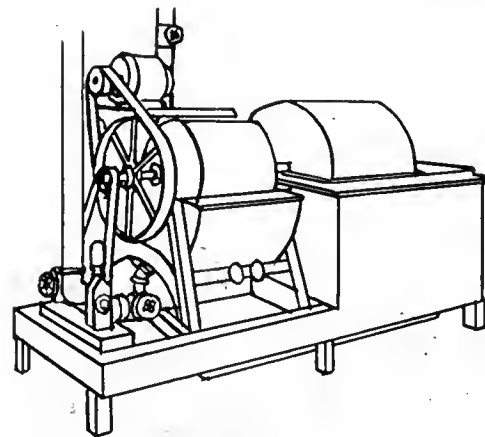

FIG. 10

made in capacities ranging from about 380 to 3,800 pounds of refrigeration in twenty-four hours under continuous operation. The "dense air" system has already been mentioned, and in its present state of development will not be further described.

(To be continued)

Single Doors for Entrances to School Buildings

A subscriber writes to us as follows:

I have noted with interest an article which appeared in THE AMERICAN ARCHITECT September 22, 1920, advocating the use of a battery of single doors for entrances to school buildings. The arrangement seems to me to embody about the maximum of usefulness when doors are likely to be in constant action, and is a treatment about which I have been enthusiastic for a long time.

It might be added, however, as in the entrance illustrated, where there are five doors, that where the greatest need is for egress, convenience would be further facilitated by omitting the handle, knob or pull from the doors at the extreme right and left, causing entrance to be made through three of the doors only and egress through all five. If this plan were adopted, and it were found to curtail entrance capacity too greatly, one or both of the end doors could be re-treated to afford entrance.

W. C. STEPHENS.

Chicago, Ill.

An Ingenious Method of Securing Weather-Tight Contact Between Swinging Doors

An original method used by a New England architect for securing weather-tight contact between two doors which swing in opposite directions has been brought to our attention by a correspondent.

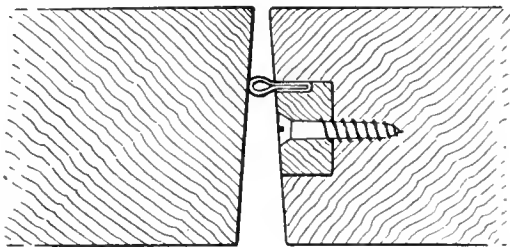

It will be seen from the accompanying drawing that a channel is routed in the edge of one of the doors. This channel, it is suggested, should be $\frac{3}{4}$ in. wide, to suit the ordinary routing plane. Fitted into this channel is a wooden strip, along one edge of which has been attached a piece of felt weather strip of the type shown. The strip can then be screwed to the edge of the door, and if at any time the weather strip becomes worn or torn a new piece may be easily fitted.

It has been found by experience that felt is much better than the rubber strip for this purpose and

that it lasts longer and does not break through constant use. Also, experience has demonstrated that the type shown with an "O" loop is better than the straight weather strip or piece of felt.

Our correspondent writes that for the last 20 years, he has seen doors trimmed in this way, and that the doors first equipped are doing as good service as at the day when they were put up.

Advantages of Bituminous Concrete Foundation

Bituminous concrete foundations for various types of pavements have proved so successful for a long period of time that considerable discussion has been given to their use at recent road building and engineering society conventions. It is interesting to note the summary of advantages of bituminous concrete foundations as given by Hugh W. Skidmore of the Chicago Paving Laboratory in a paper read before the Illinois Society of Engineers.

Mr. Skidmore summarizes the advantages of bituminous concrete foundations briefly as follows:

"(1) Provides homogeneity of mass and positive bond between foundation and wearing surface when bituminous top course are employed.

"(2) Provides uniform contact with the subgrade, thus insuring the benefit structurally of all of the beam strength possessed by the foundation slab and by the same token, makes certain uniform distribution of load to the subgrade.

"(3) Because of the inherent flexibility of the material, the foundation slab will at no time be called upon to act as an arch over weak subgrade areas, therefore the possibility of the foundation rupturing, as is frequently the case with Portland cement-concrete, will be reduced to a minimum.

"(4) Provides freedom from cracks and upheavals.

"(5) Insures against the presence of moisture in the foundation structure, thus prolonging the life of the pavement.

"(6) May be easily repaired at minimum cost; the surface patch method being applicable except in the case of very serious defects.

"(7) Provides decided economies in construction as it disposes with the equipment and organization necessary to lay cement-concrete, thus affording the contractor the advantage of exclusive use of that portion of his ordinary equipment and labor organization which in actual operation has heretofore proven to be the most economical, and thereby profitable.

"(8) Does away with the long period of time required for curing of the foundation, thus permitting

THE AMERICAN ARCHITECT

the opening of completed work to traffic immediately and providing a rapidity of turnover to the contractor not possible in the case of rigid foundations.

"(9) Permits the use of the same materials, except cement, as are employed in cement-concrete work.

"(10) Under similar conditions, using the same aggregate materials bituminous concrete of equal thickness will be found to be cheaper than cement-concrete at present prices."

Personnel Research Federation Is Organized

Under the auspices of the National Research Council and Engineering Foundation, in the building of the National Research Council, Washington, was effected March 15 the organization of the personnel research federation. This federation includes in its membership scientific, engineering, labor, management and educational bodies. The federation has been organized to bring about interchange of research information among the numerous organizations that are engaged in personnel research.

It is reported to the new federation by the bureau of labor statistics, of the Department of Labor, that there are 250 such organizations in the United States. The federation will collect research information, will encourage research through individuals and organizations and will co-ordinate research activities.

Temporary officers were elected as follows: Chairman, Robert M. Yerkes, National Research Council; vice-chairman, Samuel Gompers, American Federation of Labor; treasurer, Robert W. Bruere, Bureau of Industrial Research; secretary, Alfred D. Flinn, Engineering Foundation; acting director, Beardsley

Ruml, assistant to the president of the Carnegie Corporation of New York.

The aims of the new organization are increased efficiency of all the personnel elements of industry—employer, manager, worker—and improved safety, health, comfort and relationships.

Pittsburgh Changes Regulation on Wall Thickness

The new building code formulated by a special committee of the Pittsburgh Chamber of Commerce permits walls of a minimum thickness of 8 inches instead of 13 inches, provided the length of the house does not exceed 24 feet to the square or 35 feet to the gable point. Terra cotta block may be used in the construction. Permission is granted to omit cellar construction, provided 18 inches of air space are allowed under the first floor. The new code was drafted with the aim of making it easier for home builders.

New Administrative Engineering Course at Union College

Union College, Schenectady, N. Y., has added a new course in administrative engineering designed for training managers and superintendents of industrial plants. The course covers a period of four years, in which science comprises 26 per cent. of the total time; engineering, 39 per cent.; business administration, 10 per cent., and cultural studies, 25 per cent. The course includes studies in accounting, finance, banking, business law, contracts, and industrial management. It is designed for students more likely to be interested in manufacturing industries dependent upon engineering as a basis.

Current News

Happenings and Comments in the Field of Architecture and the Allied Arts

Where Land Costs Most

Wall street at Nassau street, and Fifth avenue at Forty-second street are rivals for the title of the highest-priced property in the world.

Roosevelt Memorial Site

Monument to Be Located in Front of Field Museum
in Chicago

Plans for a Roosevelt monument in front of the new Field Museum, at the foot of Roosevelt road, were announced by the Roosevelt Memorial Association of Greater Chicago in its annual report. The site has been agreed upon by members of the association and the south park commission as the most suitable available. Cyrus Thomas, architect, has been engaged by the commission to prepare the plans.

Meanwhile, the association is preparing to push plans for the extension of Roosevelt road from Wheaton to St. Louis, as planned in the original project.

Tower Made of Tree Trunk

Visitors Will Marvel at Adornment Set Up on
Grounds of the National Capital

Part of the trunk of a California redwood tree, 30 feet in diameter at the base, has been shipped to Washington and converted into a tower on the grounds of the Department of Agriculture. It is provided with a door and an interior stairway and is surmounted by a circular roof with dormer windows looking in four directions. The trunk is so heavy that it had to be cut into several sections for shipping.

Chinese Art

The applicability of Chinese art for interior decoration of any period is being strikingly illustrated in a recent gallery opening in New York. The idea that anything Chinese is gaudy is being gradually displaced. In the carving of gems, the working of metal and in tapestry designs the Chinese are without rivals. The owner of the new gallery has fitted up half a score of rooms in period designs—there is the old French and English, the American colonial, the early Italian and the Holland rooms. Fitting snugly into the general tone of the room are marvels of Chinese craftsmanship in the form of hangings,

carved woodwork, tapestry and lamps. It is a revelation to many and gives a new conception of Chinese craftsmanship.

Moving a City

The gigantic task of moving an entire city is slowly nearing completion in Minnesota. The city of Hibbing, 20,000 population, with substantial brick buildings and a street car line, is being moved to a new site to permit the mining of rich deposits of iron ore upon which it stood.

Georgia School of Technology

A copy of the Review for 1920, the annual publication of the Department of Architecture of the Georgia School of Technology, has been received.

The present issue consists of a number of plates which are reproductions of pen etchings and other designs and problems that have been worked out during the school year. This well conducted architectural school is contributing in a most dignified manner to the advancement of architectural education. The work illustrated is all of a nature to bring credit to the institution.

Peace Gardens for War Gardens

The war garden may be no longer necessary but the impetus given during war times to the raising of vegetables had other uses besides emergency service and it would greatly be regretted if the love of working the soil, which was thus aroused, were allowed to weaken and die out with the passing need. The practical knowledge and skill acquired by those who turned ugly back yards and vacant lots into fertile food supplies, even on a small scale, are too valuable to be suffered to lie idle and rust with disuse.

The architect can do a good service by encouraging the replanting and maintenance of these attractive additions to homes and backyards. The public should let the war garden continue to develop into the peace garden, where the love of beauty is stronger than the desire for utility, and let the flower garden supersede or at least accompany the vegetable plot.

Australian Artificial Veneers

A recent Australian invention of an artificial composition similar to veneer should be of interest to manufacturers in proximity to large supplies of waste material of vegetable origin, such as sawdust. As patent applications are pending in Australia and other countries, the inventor is at present reticent in furnishing details other than that the substance is worked up entirely from waste fibrous products and other vegetable matter, and that sawdust can be utilized in considerable quantities in the manufacture of the cheaper grades of the composition. The Canadian trade commissioner at Melbourne describes the product in the following terms:

The substance—named "Keltona"—can be used for a variety of purposes, such as chair backs and seats, furniture generally, veneers, and wall and other paneling, and can be produced to represent excellent marble effects. It is capable of being bent freely for a variety of commercial purposes, worked with tools, sawn, bored, planed, sandpapered, etc., and will take nails with ease.

A beginning has been made in manufacturing the composition in Melbourne.

Our Most Popular Building

Popular tastes in architecture vary from age to age. Greeks loved their columns, the Romans their arches. And the Americans their back yard garages!

It used to be said that the early colonial stood for American taste in building. Then the steel-framed skyscraper came and the Manhattan sky-line became a sort of national trade mark. Now comes the garage, lowly, useful, homely, ubiquitous shelter for the little old tin lizzie.

Permits for more than 4,000 private garages were issued in Cleveland in 1920. These were for the city proper; hundreds more would be added were the suburbs taken into consideration. More than 4,000 private garages and 1,824 dwellings, frame or brick. More than two garages to each dwelling.

Go back a year. In 1919 there were slightly more than 3,400 garage permits issued and 2,905 permits for dwellings, frame or brick. Taking 1919 and 1920 in comparison, garage permits increased more than 600, while dwelling permits decreased 1,081. In the same period there was a decided falling off in brick and frame apartments and tenements also, but garage building kept on its way.

These figures for Cleveland are not dissimilar to figures from other cities. Practically everywhere in America the unobtrusive little garage set in the corner of the back yard garden not only holds its

own but gains on every competitor. Material and labor costs may slow down construction when it comes to homes and business blocks, but the garage rises superior to all such considerations. It mocks economics and thrives on hardship.

South America Offers Inducements to Immigrants

The Director of Immigration of Brazil has issued a report covering admissions and nationalities from 1908 to 1919, inclusive, a period of 12 years. The total number is 1,015,813 and the high mark was reached in 1913, with admissions of 192,683. The check on immigration during the war was marked, and recovery is shown in the year 1919. The Latin group, including Portugal, Spain, Italy and France, furnished 775,523, or 76.3 per cent. of the total, though Russians, Germans and Turco-Arabs were well represented.

With the release of shipping since the war, immigration to South America has shown greater activity and various governments are making liberal inducements to settlers. Farmers are especially desired and are given land and transportation from the port of entry to their destination. Brazil, Argentine, Chile and Peru are offering concessions to immigrants who will develop the country.

Realistic Art Is Urged

George Gray Barnard Favors Idea to Win Over the Masses

Take the 4,000 or 5,000 young men and women painters and sculptors who annually graduate from the splendid art schools in America—the majority of whom go under in the struggle of life—and put them in the mines, the mills, the big industrial plants, writes George Gray Barnard. Let them depict on canvas and in marble the man who labors, and who now sneers and jeers at art. Place those canvases on the grimy walls of the factory and the sculpture groups beside the door where the workers punch the time clock. Thus reconcile the masses to art and the artist to the masses.

That is the dream of George Gray Barnard, of New York, noted American sculptor. He outlined it at a dinner given by the Art Alliance, Philadelphia. The affair marked the opening of a campaign to double the membership of the alliance from 1,100 to 2,200 and the beginning of a movement to broaden the scope and increase the activities of the organization. More than 400 men and women attended. Among the speakers, aside from Mr. Barnard, were John F. Braun, recently elected president of the alliance; David Bispham, Miss Violet Oakley, Mrs.

Harold E. Yarnall, Mrs. Ripley Hitchcock, president of the Art Center of New York, and Thornton Oakley.

Pullmans Used As Houses

Fifty Rail Employees, Unable to Obtain Homes,
Occupy Sleeping Cars

A striking demonstration of Pittsburgh's house famine is provided by the presence on a siding in the Allegheny station of the Pennsylvania Railroad of two sleeping cars, which are being used as rooming houses by about fifty employees of the railroad, who have been unable to find dwellings. The cars, which have been standing on the siding for more than a week, are costing the Pennsylvania Railroad the usual Pullman royalty, in addition to the heat, laundering of bedding and "chambermaid" service, the last being supplied by yard workmen, who could be employed more profitably in other ways.

Homes for laboring gangs in old cabooses and freight cars are not an uncommon sight on engineering and large construction jobs where there is no nearby town or settlement, but the housing of fifty men, employed in the higher grades of work, in berths for which travelers pay from \$2.50 a night up is believed to be something new.

Personalities of Cities

Cities have personalities much as human beings do. They have a spirit of their own and carry their own atmosphere. So analyzing this, the *Minneapolis Journal* notices that there is a perceptible difference felt, if not defined, when one goes from Minneapolis to St. Paul or vice versa. This difference sometimes eludes definition, but is comprehended in the term, spirit of a city.

Professor Edward A. Ross, professor of sociology in the University of Wisconsin, in his book on the "Principles of Sociology," suggests that this difference between cities is not imaginary. It is real, and it is due in part to the differences in make-up of the population.

There are "he" towns, where men predominate, and "she" towns, where women predominate. Washington, Richmond, Cambridge and Nashville have from one hundred and thirteen to one hundred and sixteen women for every one hundred men. Textile cities like Lowell, Fall River and Paterson draw more women than men, while manufacturing cities like Bridgeport, Birmingham and Detroit, draw more men than women.

But there are contrasting statements. The professor suggests that we have no means of knowing what traits a female community would develop, but we do

know that a male community has a character of its own, very pronounced in mining towns or border communities. A womanless town is in constant flux and migration. Women and homes give a community a stable character, and do much to soften the quest for gold. In a "he" town, respect for law is likely to be weak, and public opinion not very sensitive or assertive. Strenuousness is apt to characterize it, but respect for person and property limps.

Personals

William F. Wischnmeyer and W. Oscar Mullygardt have become associates with the firm of Mauran, Russell & Crowell, 1620 Chemical Bldg., St. Louis, Mo. They are both architects.

Mr. Robert O. Derrick, architect, formerly with Murphy & Dana, architects, New York City, has been admitted, as a partner, to the firm of Brown & Preston, architects and engineers of Detroit.

The present offices will be retained at 406-407-408 Empire Bldg., Washington Boulevard at Clifford street, Detroit, Michigan.

Murray Klein, architect, has moved his office from 116 Grove street, Brooklyn, to 37 Graham avenue.

Joseph A. McCarroll, architect, formerly at 32 Clinton street, Brooklyn, N. Y., is now located in the Shubert Building, that city.

J. B. Wahlquist, architect, who was formerly located at 24 East 43d street, New York City, is now practicing at 52 Beechwood Terrace, Yonkers, N. Y.

J. H. Gustave Steffens, architect, has removed his office from 870 Fourth avenue, Detroit, Mich., to 355 Collingwood avenue, that city.

B. A. Sellow, architect, has moved his offices from 223 Asylum street, Hartford, Conn., to 721 Main street, that city.

A. Sandegren, architect, 25 North Dearborn street, Chicago, Ill., will move May 1 to 116 East Oak street, that city.

William C. Presto, architect, has moved from 140 South Dearborn street, Chicago, to room 310, 179 West Washington street, that city.

Will H. Willson, architect, is now associated with Wood & Brent, realtors, 713 Lankershim Bldg., Los Angeles, Cal.

Tabulation of Building Costs

Fourth of THE AMERICAN ARCHITECT'S series of cost tables, figures for which were furnished by Architects throughout the United States, the first compilation appeared in the January 12 issue

Type of Building	Location	Type of Construction	Equipment	Foundations	Total cubic feet	Contract price or bid received	Cost per cubic foot	When figures were taken
Church	Chester, Pa.	Brick walls; reinforced concrete; wood floors; wood roof trusses; slate roof.	Steam heat; electric lights; usual plumbing.	Stone and concrete.	250,000	\$98,000	\$.392	Mar., 1921
Apartment Building	Long Beach, Cal.	Semi-fireproof; brick walls; floors, wood and cement.	Gas radiators for heat; electric lights; modern plumbing.	Concrete.	132,144	49,240	.373	July, 1920
Store	Long Beach, Cal.	Semi-fireproof; brick walls; wood roof trusses; composition roof. Floors, wood and cement.	Gas radiators for heat; electric lights; modern plumbing; freight elevator.	Concrete.	265,780	32,320	.121	July, 1920
Apartment Building	Savannah, Ga.	Fireproof; concrete; brick and tile walls; steel stud and plaster board partitions. Concrete and tile floors.	Vacuum vapor heat; refrigeration; circulating brine; electric lighting; modern plumbing; deep well water supply; emergency connection to city main; 2 electric elevators.	Reinforced concrete.	807,094	Cost plus fixed fee 473,652	.586	Sept., 1920 Jan., 1921
Store-Offices	Miami, Fla.	Fireproof; concrete and steel; interlocking tile walls; reinforced concrete flat slab floor construction.	Electric lights; no heating; 2 electric elevators.		1,314,000	479,680	.365	Feb., 1921
Boys' Dormitory	Tucson, Ariz.	Fireproof; concrete; brick walls; hollow tile partitions. Concrete joists with tile between.	Steam heat; central plant; electric lights; 13 showers; 13 water closets; 39 lavatories; 6 drinking fountains; 12 urinals; 1 bath; 3 slop sinks; stand-pipe; trunk lift.	Concrete.	404,916	180,366	.445	Oct., 1920
Suburban Hotel	New York Suburb	Fireproof; steel and concrete; walls and partitions, tile and plaster block. Floors, concrete, hardwood finish; tiled baths.	Steam heat; electric lights; street service; plumbing, high grade enamelled iron fixtures; 3 electric elevators.	Spread concrete.	1,551,000	1,100,000	.70	Mar., 1921
Grade School	Tucson, Ariz.	Semi-fireproof; brick walls and tile partitions; wood joists; metal ceilings; tile roof. Corridors and boiler room, concrete.	Direct steam heat; electric lights; usual plumbing.	Concrete.	254,916	69,508	.272	Jan., 1921
Consolidated School	Owensboro, Ky.	Non-fireproof; brick and concrete walls; limestone trimmings. Wood floors deadened. Gymnasium, lunchroom, kitchen.	Steam heat; electric lights with storage battery; usual plumbing.	Concrete.	373,598	74,000	.198	Mar., 1921
High School	Hillsdale, Ill.	Non-fireproof; brick walls; cement and maple floors.	Vapor steam heat; forced ventilation; electric lights; usual plumbing; deep well; electric pump; pressure tank.	Concrete.	284,000	73,000	.257	Mar., 1921
School	Morgan City, La.	Non-fireproof; brick walls; wood floors.	Direct low pressure steam heat; electric lights; usual plumbing.	Concrete and brick.	341,600	66,000	.193	Mar., 1921
Residence	Savannah Ga.	Non-fireproof; walls, brick veneer; wood construction and floors.	Open fireplaces; provision for gas radiators; electric wiring on "knob and tube"; 2 baths.	Concrete and brick.	30,568	12,953	.43	Feb., 1921
School	Baltimore Co., Ind.	Fireproof; reinforced concrete; brick walls; wood and composition floors.	Steam heat; direct and indirect; electric lights; usual plumbing.	Mass concrete.	350,000	168,000	.48	Oct., 1920
Residence	Portland, Maine	Non-fireproof; brick walls; slate roof; tar and gravel deck.	Vapor heat; electric lights; 4 baths; good fixtures.	Concrete to grade; brick to 1st floor.	38,688	5,000	.129	Sept., 1921
Residence	Birmingham, Ala.	Non-fireproof; frame; cement basement floor; others, wood.	Furnace heat; electric lights; knob and tube wiring; 1 bath room. Medium fixtures.	Rubble.	80,352	43,634	.543	Mar., 1921
Residence	Morgan Field, Ky.	Non-fireproof; brick walls; pressed brick face. Oak floors.	Vapor heat; electric lights; 2 baths; lavatory laundry; high grade fixtures.	Mass concrete.	72,000	27,500	.382	Mar., 1921

Reports of Special Correspondents in Regional Centers

Building Conditions as Viewed by Competent Observers, Gleaned from Sources of Undoubted Authority—Current Prices of Materials, and Statistics of Construction Work now in Progress or Contemplated

THE BUILDING SITUATION in the MIDDLE WEST

(Special Correspondence to THE AMERICAN ARCHITECT)

CHICAGO.—Building difficulties with special reference to the labor arguments will come to an acute focus here not later than May 1, according to present calculations. On that date, the contractors of the city propose to begin operating on a new wage scale. The building trades unions have not yet signified their acceptance of the proposed scale and the possibility of a strike is not particularly remote.

The labor issue, which is one of the things which are retarding building in this city, has become increasingly important during recent weeks until a stage has been reached where the resumption of building activity seems to hinge mainly on that point.

The building trades unions are holding out for a wage schedule of \$1.25 per hour for skilled labor and \$1.00 per hour for unskilled labor. The contention of the contractors' association is that the cost of living has decreased and that the proposed higher rate which was suggested because of increased living costs must also be foregone in view of the readjustment processes which have taken place since the rate was suggested.

The proposal of contractors for a reduction amounts to an ultimatum, and the Central Building Trades Council has submitted a counter-proposal that the entire wage discussion be submitted to a board of arbitration. Contractors object to this on the ground that there is nothing to arbitrate, and thus the matter stands. May 1 is the date on which the contractors propose to put the new rate into effect, and the assumption is that the union builders must accept the wage or face the possibility of an open shop. The matter of a reduced wage schedule has been submitted by referendum to members of the various affiliated unions, and in practically all cases the proposal has been rejected. In view of the fact, however, that a very large percentage of the building trades union members have been without employment for several months, the union leaders find themselves in a bad strategic position in which to

combat the offer of plenty of work at a slightly lower wage. Reductions of a similar nature have been accepted by union builders in nearby cities. Kenosha, Wisconsin, and Freeport, Illinois—to mention only two—have already secured a reduction of building labor costs and are now ready to go ahead with whatever building is in contemplation.

Aside from the building labor squabble, chief interest centers this week in the continuance of the joint legislative inquiry of the building tie-up in Chicago. State Senator Dailey, at the head of the committee, has been directing a very vigorous probe into various unhealthy building restrictions, and while the meetings of the committee are executive, the press has nevertheless been able to print rather a complete report of the proceedings.

The committee claims to have discovered a policy of national price fixing of building materials. The regulation is alleged to have been brought about by associations. To be definite, the Chicago Retail Lumber Dealers' Association is one of the organizations into whose methods and policies the committee has already inquired. Associations of brick, stone, gravel, sand and plumbing supply dealers have also earned the uncertain distinction of a survey by the committee.

The so-called "Kelly plan," which originated primarily, it is said, with the lumber dealers, and was named in recognition of its inventor, is said to be applied in whole or in part by other associations. The committee has been directing inquiry upon the assumption that through the use of this and similar plans of quasi-price fixing the associations have been able to exert an unhealthy influence on building materials prices in Chicago.

A Chicago newspaper, quoting Representative W. L. Pierce, one of the investigation committee, outlines the plans thus:

"These local organizations are tied up with the associations of the men from whom they buy their materials, and any one caught selling below stipulated figures has a hard time getting any material to sell after he has disposed of his stock at hand. Witnesses described their entire operations to us, and their stories are that when a dealer sells under

THE AMERICAN ARCHITECT

the market price he is warned. The second 'offense' finds him strangely discredited in not only his own community but all over the country.

"How does it happen? Easy. The local organization notifies the association of manufacturers, and when the dealer who has offended seeks additional materials the only reply, whether it comes from Chicago, Texas, or Maine, is that there are none on hand to send him. In the meantime the other dealers continue to get all the materials they want and are able to sell them. The man who sold more cheaply must either agree to obey the rules or get out of business."

Testimony of this nature was given against the Chicago Face Brick Association, some eight or ten members of which were called to testify.

Some very interesting and unusual instances of labor hold-ups on Chicago construction work have also been uncovered by the committee. That no important building in Chicago within the last few years has failed to pay tribute in the form of "graft" is the assertion that has been frequently made during the hearing.

Forty members of one of the building trades unions addressed a request to the committee asking its assistance in getting rid of their president and business agent. The workers asserted that the individual in question was "one of the biggest crooks in Chicago."

The legislative inquiry is covering the whole building situation, and some very big men will be called before the inquiry ends. One of the leading Chicago contractors is said to have left town because he had been tipped off that he was to be called to testify. Contractors and building owners have been rather timid about testifying in many instances, and particularly in reference to alleged "hush money" payments to union leaders.

The discussion between the architects and the Lumbermen's Association of Chicago, which began in a very heated way, has simmered down to nothing at all. F. E. Davidson, president of the Illinois Society of Architects, made the assertion that lumber is still 150 per cent. higher than the peak in 1914. N. A. Mather, president of the Lumbermen's Association, denied this charge vigorously and offered a reward, payable to charity, if Mr. Davidson and his associates could establish proof of a higher level than 64 per cent. above 1914 prices. The offer was seized upon by the architects, and a board of judges was summoned to weigh the respective arguments. At the preliminary hearing, it developed that a basis of comparison could not be agreed upon and the affair was dropped. New differences between certain groups of architects and the retail lumber dealers have since arisen.

The new trouble has arisen from a request by the architects—members of the Illinois Society of Architects—that the local lumber dealers adopt the grading rules of the Forest Products Laboratory in order that building ordinances might be adhered to more strictly. The reply of the lumbermen's committee to that proposal was as follows:

"We will have to be assured by the architects that they will only specify lumber to be furnished by the Chicago yards, no shipment to be made from the mills. You appreciate we would have to have this assurance, as otherwise we could not afford to carry these timbers in stock and then have the timbers shipped in from the mills direct."

Mr. Davidson, serving as chairman of the architects' committee, replied thus:

"If this is the attitude of the lumber interests, then we will forget the entire incident and let every architect do as he pleases. The architects are willing to co-operate, but certainly the lumber interests should meet the committee in the same spirit."

Stripped of its polite phraseology, the proposal and its rejection by the lumber interests indicate that the architects regard the attitude of the lumber interests as being designed to keep Chicago architects from buying no lumber except through local lumber manufacturing representatives.

Prices of lumber and materials have not changed substantially during the past week. There is a very slow downward trend in the lumber market, although there is no official verification of slumping quotations. Present prices are:

Yellow Pine: B. & B. 1-in., \$95 to \$130, depending on thickness; 2 x 4, No. 1, 10 to 16 ft. length, \$51 to \$53; 2 x 6, \$48; 2 x 8, \$50; 2 x 10, \$53; 2 x 12, \$55; 13-16 x 3 1-4 z & b flat flooring, \$85 to \$90; 1 x 6, No. 2 common, \$48 to \$90. *Douglas fir*: 2 4 S, in sizes up to 12 x 12, in length up to 32 ft., \$65 to \$70; 14 x 14, \$68 to \$73; 16 x 16, \$72 to \$75; 18 x 18, \$75 to \$90. *Hard Maple*: Four 1-4 No. 1 and 2, \$135; select, \$120; No. 1 common, \$100; No. 2 common, \$65; No. 3 common, \$32. *Birch*: Four 1-4 No. 1 and 2, \$160; select, \$133 to \$138; No. 1 common, \$95 to \$100; No. 2 common, \$60 to \$65; No. 3 common, \$40. *Red Gum*: Four 1/4 No. 1 and 2, \$150; No. 1 common, \$90 to \$92; No. 2 common, \$45.

Face Brick—Standard, vitrified red, \$32.00@34.00; Smooth, Indiana red, \$38.00@40.00; Smooth, Ohio red, \$38.00@40.00; Smooth, Pennsylvania red, \$46.00@48.00; Smooth, buff, \$45.00@47.00; Smooth, gray, \$47.00@49.00; Rough, buff, \$44.00@46.00; Rough, gray, \$47.00@49.00; Variegated, rough texture, \$34.00@49.00.

Common brick, \$12.00@14.00 per M. Portland cement, \$2.25 per bbl. Torpedo—Lake and bank

THE AMERICAN ARCHITECT

sand, \$3.50 per yd. Crushed stone, gravel, screenings, \$3.50 per yd. Hydrated lime, Ohio, paper, \$21.00 per ton. Hydrated lime, Ohio, cloth, \$20.00 per ton. (Includes sacks at 30c. each). Hydrated lime, Wisconsin, paper, \$18.00 per ton. Bulk lime, \$1.60 per ton.

John C. Christensen has been appointed architect

for the Chicago Board of Education, succeeding Arthur F. Hussander, who has recently resigned. Mr. Christensen was formerly Mr. Hussander's assistant. The Board of Education has a building program for the next three years entailing the expenditure of \$20,000,000 for new school buildings.

BUILDING CONDITIONS on the PACIFIC COAST

(Special Correspondence to THE AMERICAN ARCHITECT)

SEATTLE.—Due to the apparent compromise between corporation and outside mills on sheets of which official notification has been received on the coast, jobbers believe that the unsettlement in prices of these building essentials is over, and that the apparent purpose of checking the downward tendency and of stabilizing so that building investors can feel safe bids fair of accomplishment.

It was noted by jobbers through the past 60 days of sheet unsettlement that weaknesses were followed immediately by withdrawal of inquiries. It seemed difficult for jobbers to wean buyers of the idea that repeated recessions were not impending. On the new basis of settlement between the groups of eastern mills galvanized sheets are now \$6.85 out of the warehouses and blacks are \$5.75. Jobbers are convinced that a brisk buying movement will follow if present prices stand steady for 10 days.

Pipe is steady, but there are reports, so far unconfirmed from official sources, that outside mills have reduced prices \$10 per ton. Inasmuch as these reports seem to bear the more or less genuine stamp and stocks in warehouse are already fair, jobbers will wait for developments.

There is an abundance of brick, roofing and plaster units. Cement is being accumulated, but coast road building for the year will undoubtedly keep the supply light and prices firm.

Plank and small timbers and big sticks are weak at the fir mills. Railway purchasing agents have kept out of the market on instructions from headquarters in the east owing to the desire to get the lines of a revenue paying basis before authorizing further expenditures, even for maintenance. The heavier cuttings of fir are therefore accumulating. General retail yard or eastern building assortments are steady, with an increasing shortage in vertical grain flooring, finish and long dimension. There seems to be no thought in the West Coast fir producing territory today of any price recessions in fir. A group of wholesalers who two weeks ago sent price lists to eastern buyers showing reductions of \$3 per 1,000 feet under the actual cost today for May delivery booked a number of orders which the

mills are refusing to sell on the offers. Attempts to bear the market have, therefore, proved futile.

Average sales at the mill bear out the general strong undertone. Flooring sold at \$49 in 1 x 4 No. 2 and better with \$21 and \$23 for the No. 3 stock. Slash grain flooring moved at \$18 to \$27. Finish \$46 to \$53. Drop siding left the mills on an average of \$20 to \$26, boards and shiplap at \$12 to \$14.50, dimension at \$10 to \$11.50, plank and small timbers at \$15.50 to \$19.50 and timbers 32 feet and under at \$19 to \$22. About 60 per cent. of the fir mills are in operation. Production for the week was 39 per cent. below normal. Orders were firm for 1,385 carloads 30,000 feet to the car to move by rail into the eastern building trade and 1,385 cars were shipped, leaving an unfilled balance for eastern rail shipment of 3,700 cars.

The fir lumber movement into the Atlantic seaboard territory on the water rate of \$20 to New York has been heavy. New business for intercostal account for the week totalled 6,982,252 feet, with shipments for the same period of 11,674,000 feet and an unshipped balance of 56,325,000 feet.

President R. W. Vinnege, of the West Coast Lumbermen's Association on his return this week from an extensive eastern trip, says that millions of dollars' worth of building throughout the country is projected and awaiting lower construction costs, and that labor is the greatest item and holds a strategic position. He says that if labor generally will accept the reduction of 25 per cent. from peak wages a tremendous building activity will result.

Beezer Bros., architects, Seattle, have been commissioned and are working on plans for a hospital to be built at Marshfield, Ore., for the Sisters of Mercy. The initial units will cost \$200,000. It is to be five stories in height, of concrete and brick construction.

A central assembly building for all motor stages operating out of Seattle has been financed in the block between Western avenue and Post street and Marion and Madison street, Seattle. The building is not new. It will have accommodations for discharging and loading 5,000 passengers daily. The controlling corporation has executed a 20-year lease and will make alterations to cost \$20,000. Waiting rooms, ticket offices and rest rooms will be provided. A marquis 200 feet long will be erected for protection of passengers in inclement weather.

542²

front piece to No. 2567



DETAIL OF DOORWAY—RATHAUS, LUCERNE

543

THE AMERICAN ARCHITECT

VOL. CXIX

WEDNESDAY, MAY 11, 1921

NUMBER 2367



THE MAIN STREET, THRUMS

A motion picture town, built to film a dramatization of "Sentimental Tommy," by J. M. Barrie

ARCHITECTURE and the MOTION PICTURE

By CARL A. ZIEGLER

THROUGHOUT the ages humanity has struggled with the problem of self-expression, yet with all its accomplishments along that line man will probably never thoroughly understand man until some genius invents a means of reading thought. Then we shall understand each other.

Just when man learned to talk we do not know, but pantomime probably precedes voice. Man soon learned that voice alone did not adequately express his emotions, so he invented music and with the aid of music man has managed to express his emotions perfectly.

Man, however, was not satisfied that his thoughts or his deeds should perish with the song, so back

in the prehistoric days we find records of man's first efforts to tell a story by means of pictures. The cavemen of Europe may have had less brain capacity than men of today, but the pictures which they cut on the walls of the caves which formed their habitations have defied the ages and tell us today of deeds that occurred long before the pen of history started to record the acts of man.

When prehistoric man first made use of pictures to tell his story we do not know, but from the records which he has left we may infer that human nature has not changed very much through all the ages.

A man more intelligent or stronger than his fellows rescues a maiden of his tribe from a wild ani-



THE VILLAGE SMITHY, THIRUMIS

mal, which he kills. He suspends the skin before the door of his cave, but in time the skin is destroyed. To kill a wild beast is a brave deed, and the man desires that his children and his neighbors shall remember his strength and courage, so he cuts as well as he can, into the stone something that resembles the animal which he has killed. Wishing to have the sign attract as much attention as possible, he daubs his figure with red earth. He did not understand the art of writing "titles" to which our experts of today give so much attention, but nevertheless he has clearly told his fellow man that "here dwells the man who is courageous and strong enough to slay a beast."

From this crude beginning the art of picture writing developed until we have histories of nations told by pictures, some of which are extremely interesting, but unfortunately very little known to the layman of today.

Like the directors of the modern picture play, the artists of prehistoric days soon formed certain immutable rules, some of which may appear very queer to "picture lovers" now.

It was the custom of the primitive artist to make the hero huge and the beast which he slew very small. By this the artist wished to convey an im-

pression of the strength of the hero. The idea that a small man who killed a huge beast would be much more impressive was too complex an idea for the primitive artist.

In all the antique sculpture of India and Egypt the conqueror is represented as colossal, while his enemies are always very small. This idea would hardly suit the hero of the modern "picture play,"



THE VILLAGE SCHOOLHOUSE

THE AMERICAN ARCHITECT

who wants his enemies very large in order that they may fall the harder.

Another rule observed in the early pictures was that the conquered man or beast must not be shown fighting back, complete submission to the hero being always depicted. In the Egyptian pictures the spear of the conqueror was in the eyes of the pigmy slaves or his lash upon their backs. Not until the days of Assyrian and Greek sculpture did we see the beasts or the enemy offering more than half-hearted resistance to the conquerer.

With the invention of language a larger scale of expression was possible, but up until modern days a very large percentage of the people was illiterate and received their deeper impressions through painting, music, sculpture and architecture, by which means the great "masters" of the world have been able to convey to mediocre minds great visions which only the master mind could seize and present in concrete form to those less gifted. This is the gift which true Art has given to mankind.

Greek art is the concrete expression of an intellect never excelled in the world's history. The glory that was Rome's may be visualized in the architectural remains of that great nation. In Gaul and Britain the conquering legions erected massive Ro-



A TYPICAL VILLAGE HOUSE



DAVID GEMMEL'S HOUSE, THRUMS

THE AMERICAN ARCHITECT

man structures that conveyed to the conquered people very definite ideas of the power of the Roman Empire. The Master Painters have been able through the medium of pictures to convey to the lay mind wonders of nature that would not have been comprehended without the genius of the master. Beethoven and Wagner have caught and imprisoned in music the elusive spirit of the forest with the everlasting weaving of its shadows, so that the dullest mind may understand its majesty, although they might not themselves have observed this phenomena in the forest itself.

May it not be that in the future, when the art is further developed, a super-director of the "picture play" may succeed in impressing upon the great masses of the people a realization of the vital truths in Architecture and the kindred arts to which the sordid conditions of modern life have, it would appear, closed their eyes?

Despite very sincere efforts the architects, sculptors and painters of America have failed in this purpose; not entirely, perhaps, but the vision is vouchsafed to so very few of the toilers to whom a realization of the higher aspirations contained in the fine arts would mean so much.

In the fifth book of "Notre Dame" Victor Hugo states "that before the invention of the printing press, in the fifteenth century, architecture was the principal, the universal writing; that up to that period all human aspirations and endeavor were built into masonry and that every popular idea as well as every religious law had its monument."

With his marvelous genius at word painting he described how succeeding types of architecture took possession of the public mind and became the concrete expression of a people; until, through a transitional period influenced by some great intellectual change, it developed into another type which more fittingly expressed the new ideals.

He calls attention to the fact that in the fifteenth century architecture lost its function as the chief recorder of human advancement and "the stone letters of Orpheus gave way to the leaden type of Guttenberg." However abstract this expression may appear to the layman of today, the architectural student has no difficulty in interpreting

from the architectural remains of the past the characteristics of the people who formed the civilization which it records.

There is perhaps no other industry in the country that has been as successful as the motion picture industry in reaching the public and really securing their interest in what it has to present, and, obversely, there is perhaps no other profession that is less understood by the general public than the architectural profession.

The result of this condition is the fact that the motion picture industry in a very few years has become one of the largest industries in the country, whereas the public has only a very vague idea as to just what the architect is driving at in his periodic railings at the lack of appreciation on the part of the public.

The architects of this country have thus far failed in their efforts to instill into the minds of the American public a deep conviction as to the importance

of the part which architecture has played in the activities of mankind, and their failure to secure a proper place for their subject in the general educational courses of any of our larger colleges does not augur well for the future.

History has taught us, however, that any real truth, although held to be the

dream of an idealist today, is often the creed of the minority tomorrow, eventually to become the faith of a people, "*Vox populi, vox Dei.*"

"America" is simply an idea and hardly old enough to have been tried out, but from the day when the Pilgrims knelt in prayer on the shores of the New World to the day when America's sons went courageously back to the Old World to fight for liberty there has always been an element of truth and sincerity in her history and a complete avoidance of the desire for conquest. This element was adequately "registered" in our colonial architecture and it is not beyond hope that we may rise above the present turmoil of commercial enterprise and in a quieter mood register a truer architectural expression of our national ideals.

The producer of the motion picture play is primarily a keen business man; no captain of industry has studied his field more carefully. With



DR. McQUEEN'S HOUSE, THRUMS

THE AMERICAN ARCHITECT

him the unpardonable sin is to attempt to produce something that is over the heads of his audience. He is not in business primarily to educate people. What was it then that led the large producing concerns to add to their staffs the capable "art director" and still more recently the "architectural director"? This would not have been done had the public been satisfied with the crude settings that we remember in the early productions. Possibly very few recognized the anachronism in using arches in a period antedating the invention of the arch, or in the use of the Roman orders in a purely Greek composition. But the producer has found that his architectural settings do convey to the public very definite impressions that he wishes them to have in order to realize fully the character of the actors in the play, and he is willing to go to very great expense to secure even the slightest advantage in this respect.

As an illustration, I was inspecting a very cleverly designed "set" at one of the larger studios recently and was very much interested to have the "art director" call my attention to the fact that this charming interior had been entirely reconstructed after the first scenes were taken in order to emphasize the regeneration of the principal character in the play (the original decorations having been of a very gay and bizarre nature). The director might have been forgiven for using the same "set" throughout, but the true artist recognizes the fact that genius is the ability to take infinite pains to produce what to duller minds are none but very insignificant results.

The Famous Players-Lasky Corporation has recently built at Long Island City an extensive group of concrete buildings to be used exclusively for motion picture production. Here a large force of draftsmen under the very competent supervision of Mr. Robert M. Haas, the "architectural director," designs the "sets" as carefully as the architect designs the building for his client. In fact, I think the actors make much better subjects than the average client, as they usually permit the director to do the designing without introducing any pet hobbies of their own and are entirely willing to be fitted with the proper architectural surroundings to conform to their character.

Before any of the "sets" are designed, the architectural director must carefully study the scenario,

and after the director of the play has decided upon the salient characteristics to be emphasized, the sketch designs of the "sets" are submitted for his approval. One may imagine that the director is a very busy man, for from the moment he first reads the scenario until the last "shot" is taken, his mind is the depository for innumerable details, all to be properly catalogued and brought forth at the proper time, and any lapses upon his part are apt to stand out upon the screen much like the spots upon the hands of the ambitious spouse of "Cawdor's Thane" and to receive the same abjuration.

The photographs illustrating this article show a village built by the Famous Players-Lasky Corporation as a setting for a production of Barrie's "Sentimental Tommy," and give some idea of the length to which a producer will go to create a proper atmosphere for his play.

As an architect who has devoted considerable study to this class of work I must confess that I was amazed when I was driven from the studio in Long Island City to the site on which this village had been erected, and after much study of this and other architectural efforts on the part of the Lasky Corporation I venture to prophesy that the producer of the



A HOUSE IN THRUMS

motion picture play may yet succeed in doing what the architects of the country have failed to do, namely, the creation of a medium that will make architecture understandable to the general public.

A topographical survey was made of the site that had been leased for the purpose. A careful model of the ground was made and the general plan of the village was laid out thereon.

In an incredibly short time the drafting force had prepared sketches showing the character of the buildings to be erected and in ten days after the scheme had been approved a force of carpenters, etc., was busy erecting the framework of light studing on which the buildings were to be formed, the entire village being completed in three weeks.

It must be remembered that for the purposes of the modern picture play the ordinary stage setting will no longer suffice. With the exception of the church in the rear of the group (which was added to help the skyline), these buildings are in three dimensions, all being practicable buildings, excepting that some are finished only on the side toward

THE AMERICAN ARCHITECT

the camera, the rear showing the supporting framework only.

The walls and roofs are covered with burlap, compo-board, plaster, anything that will give the proper texture. In no case is stone used for the walls or tile for the roofs; even the roadside walls and bridges are modeled of plaster and painted. How Mr. Haas and his assistants were able in so short a time to give the necessary instruction to the army of workmen, to produce so successfully the old effects shown in the photographs, giving the im-

The story which the architect has told in this charming bit of craftsmanship will "get over the footlights" and be understood by any audience. The play could not create the same impression if enacted upon "Main Street" in one of our typical country towns.

All architectural students realize what a tremendous influence the great expositions have had upon architecture in this country. We date our revival from the World's Fair at Chicago. These expositions were naturally of a monumental character and



THE HOUSE OF THE PAINTED LADY

pression of centuries of use, may well be a matter of amazement to the architect, for we all know the difficulty of attempting to produce that feeling of simple craftsmanship in the materials which we use in similar types of buildings.

It will be noted that not a single human being or an inscription of any kind is shown in these photographs and yet by the use of architecture alone an atmosphere has been created which needs no architectural interpreter. The labor of generations of simple craftsmen is obvious in the village, and of course this atmosphere must necessarily have its influence upon "Tommy and Grisel" when the fate shall set them down in its midst.

all who saw them must involuntarily have felt the spirit of grandeur, which architecture can so well depict. Thereafter the inartistic buildings foisted upon the public as examples of classical design, and formerly much admired, were regarded as solecisms no longer to be tolerated. Many millions of dollars were spent on these expositions which were demolished in a few years, but the educational value of the spirit which they generated is incalculable.

The patrons of the "picture play" far outnumber those who attend expositions, and the thousands of letters of criticism or commendation received by the producers indicate the interest taken by the public in all that is shown upon the screen. The possibility

THE AMERICAN ARCHITECT

of visualizing the true spirit of the fine arts, so that it may become to the general public something more than the exotic bauble of the dilettante who patronizes art merely as an accomplishment, is limited only by the intelligence and the imagination of the director.

He is not limited to the classical or monumental, but may depict the spirit contained in the humbler forms of art, which after all is what is needed most in America to-day; the art which has a message for the masses is indeed a true art.

Let the skeptic climb to the top gallery of the theatre and watch the swarthy sons of Italy glory in the triumph of "our Verdi" or stand before the Magdalen in the Baptistry at Florence as I have done, while a kindly laborer with a loaf of bread tucked in the front of his blouse explains that the statue was done by "our Donatello" and doubt the capacity of the masses to appreciate art.

Unlike the architect, the director of the picture play has the opportunity of explaining his archi-

ture through the action of the play. Many have looked through "A Window in Thrums" without seeing what Barrie saw, but when he had set down the vision in his inimitable way the little Scotch village found a very warm spot in the hearts of book-lovers throughout the world.

Nothing is to be gained by placing the fine arts in a position where they become the subject of smug pedantic discussions of the "high brow" variety, and the architects of this country should assist in every way possible the movement to secure for American audiences the very valuable inspiration which comes from seeing with comprehending minds great architectural conceptions.

The most matter-of-fact business man receives such an impression on his first trip abroad (although it does seem to wear off). But what is to prevent the much maligned picture play from doing what our great colleges have failed to do, namely, the teaching of architecture as a matter of general education?



A STREET IN THE VILLAGE OF THRUMS

CALCULATION of ENTASIS

By J. T. TUBBY

THE customary method of finding the entasis on the profile of a column is a long process. It consists in projecting the upper diameter of the column upon a quadrant with a radius equal to the lower diameter, finding the point of intersection, dividing the remaining sector into five or ten parts and transferring the points thus found back to the profile of the column in elevation. See Figure No. 1.

There appears to be no reason why this process should not be simplified and greater accuracy obtained, as well, by the use of the following expression (See Figure 2):

Rule: "A" equals the difference between one-half the lower diameter and one-half the upper diameter of the column. Then

"B" equals .647 x "A"
 "C" " .367 x "A"
 "D" " .164 x "A"
 "E" " .041 x "A"

The rule applies equally well whether the column is Tuscan, Doric, Ionic, Composite or Corinthian. Moreover, the rule has a wide range of application; if the upper diameter is $4.2 \div 6$ or $7/10$ of the lower diameter instead of the usual $5/6$, the difference due

to this change is negligible. Conversely, if there is very little difference between the upper and lower diameters, say, the upper diameter is $11/12$ of the lower diameter, the rule still holds good to within a very small error.

The method shown will eliminate errors due to mechanical instruments and save the graphic plotting indicated in Vignola.

For a closer calculation, using $5/6$ of the lower diameter for the upper diameter and carrying the rule to ten parts in place of the five shown above, we obtain the following (See Figure 3):

Rule: *"A" equals the difference between one-half the lower diameter and one-half the upper diameter of the column. Then

"B" equals .8144 x "A"
 "C" " .6467 x "A"
 "D" " .4972 x "A"
 "E" " .3667 x "A"
 "F" " .2555 x "A"
 "G" " .1639 x "A"
 "H" " .0928 x "A"
 "I" " .0411 x "A"
 "J" " .0103 x "A"

*The suggestion is made that a rule so short can be filed in the back of "Kidder" for reference.



A VIEW IN FIELDSTON, N. Y., SHOWING THE GARDEN EFFECT OF THE NEIGHBORHOOD, WITH THE HOUSE OF MR. JOHN W. GRIFFIN IN THE DISTANCE

DWIGHT JAMES BAUM, ARCHITECT

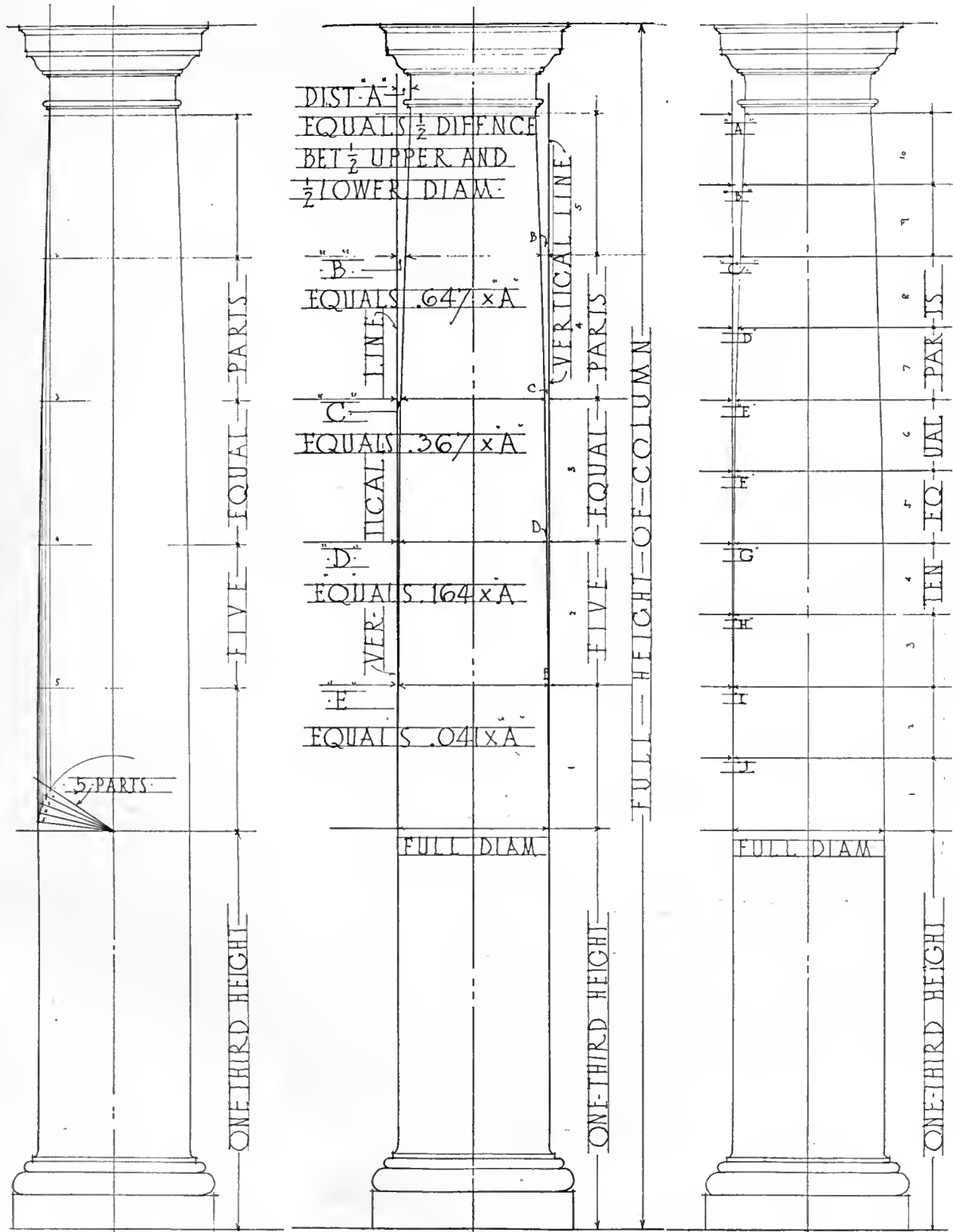

FIG. 1

FIG. 2

FIG. 3

THE CALCULATION OF ENTASIS ON THE PROFILE OF A COLUMN

(See article by J. T. Tubby, Architect, on preceding page)



SCULPTURAL TREATMENT OF FOUR MICHIGAN AVE. BRIDGE
HOUSES COMMEMORATING FORT DEARBORN AND THE FIRST
WHITE MAN'S HOUSE IN CHICAGO - DONATION OF
WILLIAM WRIGLEY JR AND FERGUSON FUND TRUSTEES.

WITH the completion of the great double-deck bascule bridge at Michigan Avenue, in Chicago, come other improvements which promise that the reconstructed street will surpass any business thoroughfare in the world.

After an educational campaign instituted in 1909 by the Chicago Plan Commission visible signs are apparent which demonstrate the wisdom of the planners. The campaign has so imbued the voters of that city with the desirability of the entire scheme that bond issues have been voted to carry on the work.

NEW GATEWAY OF THE
GREATER CHICAGO



ONE HUNDRED THOUSAND DOLLARS GIVEN JOINTLY BY
WILLIAM WRIGLEY JR AND FERGUSON FUND TRUSTEES
TO EMBELLISH FOUR MICHIGAN AVE. BRIDGE HOUSES, MARKS FIRST STEP
IN MAKING THIS GATEWAY AS FAMOUS AS THE PLACE DE LA CONCORDE IN PARIS.

THE Michigan Avenue improvement, while of great importance, is only one of the many elements of the general plan, some of which are completed and several under way. Through the generosity of William Wrigley, Jr., whose new office building is shown at the right of the illustration, and the Ferguson Fund Trustees, the sum of \$100,000 is made available for the embellishment of the four bridge houses. The Ferguson Fund was instituted several years ago for the purpose of purchasing works of sculpture to be placed in various parts of Chicago. As soon as condemnation proceedings are completed the reconstruction of South Water Street will begin.

Old State House, Philadelphia, Pa.

(See reproduction of original drawing by O. R. Eggers on opposite page)

THE Old State House in Philadelphia, the birthplace of our national life, was begun in 1729. Its progress toward completion was slow, and when the Assembly met for the first time in this building in 1735 it was far from finished. The great and historic chamber, known as Independence Hall, was not completed until 1742.

The graceful lines of this historic structure present a fine example of our Colonial architecture. The building is one of dignity and has a fine sense of fitness and proportion.

In its original setting it was embowered by tall trees and formed a part of the mighty woods that gained for Pennsylvania its sylvan name.

5-54^a



CREAKLY
Philadelphia

OLD STATE HOUSE, PHILADELPHIA, PA.
THE AMERICAN ARCHITECT Series of Early American Architecture



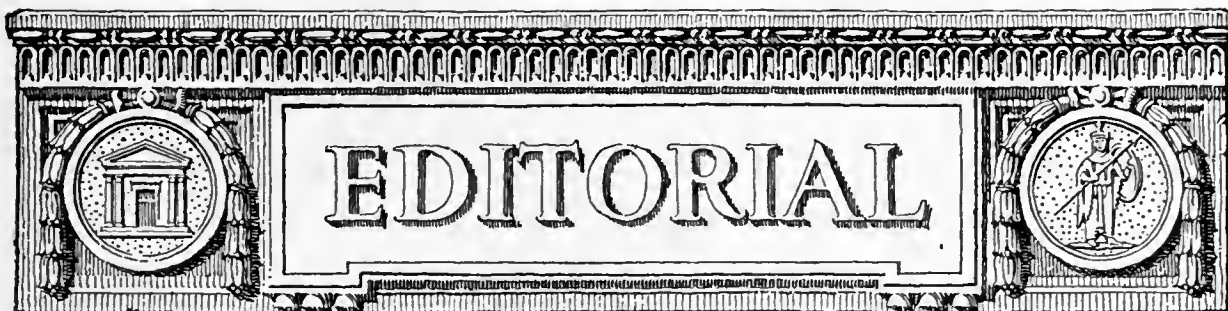

EDITORIAL

Elimination of Waste in Building Industry

WE are beginning to look hopefully to Philadelphia as the one important city in the East where constructive effort in solving the intricacies of our building problems is made. A meeting held in that city late in April was called by the allied building interests to discuss the vital subject of the elimination of waste in the building industry. The meeting took place in a prominent church, and everyone discussed the matter of wasted effort, expense and time.

Undoubtedly a large part of our building costs consists of waste. We have been and are today, in spite of the lessons taught by the war, prodigal in these directions. There exists little, if any, effort to conserve. We waste and add this waste to costs.

Now, while we are marking time in building, there can be no better opportunity to discuss these vital things, and the Philadelphia meeting is a movement in exactly the right direction. Why not other similar meetings in all of our larger cities? Why look further for a topic when here is one ready to hand?

Albert Kelsey addressed the Philadelphia meeting at some length. As a practical man, he naturally had studied this matter of waste. What he said was worth saying. He stated in part:

The great waste today is half-heartedness. Half-hearted architects and builders and tens of thousands of half-hearted members of the building trades are wasting their lives worrying about their rights while neglecting their duties. But I do not refer to moral obligations, but rather to the selfish interests of such architects, contractors and members of the building trades themselves, many of whom are losing the joy of working as well as their self-respect. The plan-factory is replacing the architect; the building-broker is replacing the master-builder, and the unskilled loafer, the honest artisan.

Now, half-hearted architects, builders and members of the building trade can be easily singled out by the disorderliness and lack of care with which they conduct their building operations, while conversely it is undeniable that the happy, orderly, successful architects, builders and workmen are those who eliminate this element of waste. It is not, however, solely because they make money that they are happier, but rather because of a consciousness that they are superior men taking a genuine delight in doing things in a clean, whole-hearted manner, and thereby have learned some-

thing of the beauty and dignity of rearing buildings that satisfy.

Referring to waste in the building industry, Sanford E. Thompson, an industrial engineer of Boston, in an address in Philadelphia before the associated building trades, stated that certain waste stands out sharply in the building industry. This waste, he stated, was, in the order of its importance, loss of working time throughout the year, poor planning and lack of knowledge of the day's work.

The first of these is directly the result of the other two, and all three indicate errors of building organization. Such inefficient organization promotes waste.

"If the waste in industry could be eliminated," said Mr. Thompson, "the wages and salaries of every man could be increased."

It is generally conceded that the key to the problem of the resumption of building is the reduction of costs. The careful study of the matter of waste and how it may be reduced, if not altogether avoided, will be a long step toward the reduction of costs and early building activity.

New Jersey Abolishes State Architect

THE office of State Architect of New Jersey, held by Francis H. Bent for a number of years past, has by legislative action been abolished, and the duties of the department under this act are transferred to the Department of Institutions and Agencies.

It is regrettable that a department of a State government, so very important as one of architecture, should have been abolished, and it is further regrettable to be able to detect the influence of politics in this action.

Architects have only to consider carefully the very satisfactory results that have been secured in the State of New York by the efficient management of the State Department of Architecture, to be assured of the value of such a bureau in every State throughout the country. It is, therefore, with regret that we learn that progress in this matter should have been halted as it is by the action of the New Jersey State Legislature.

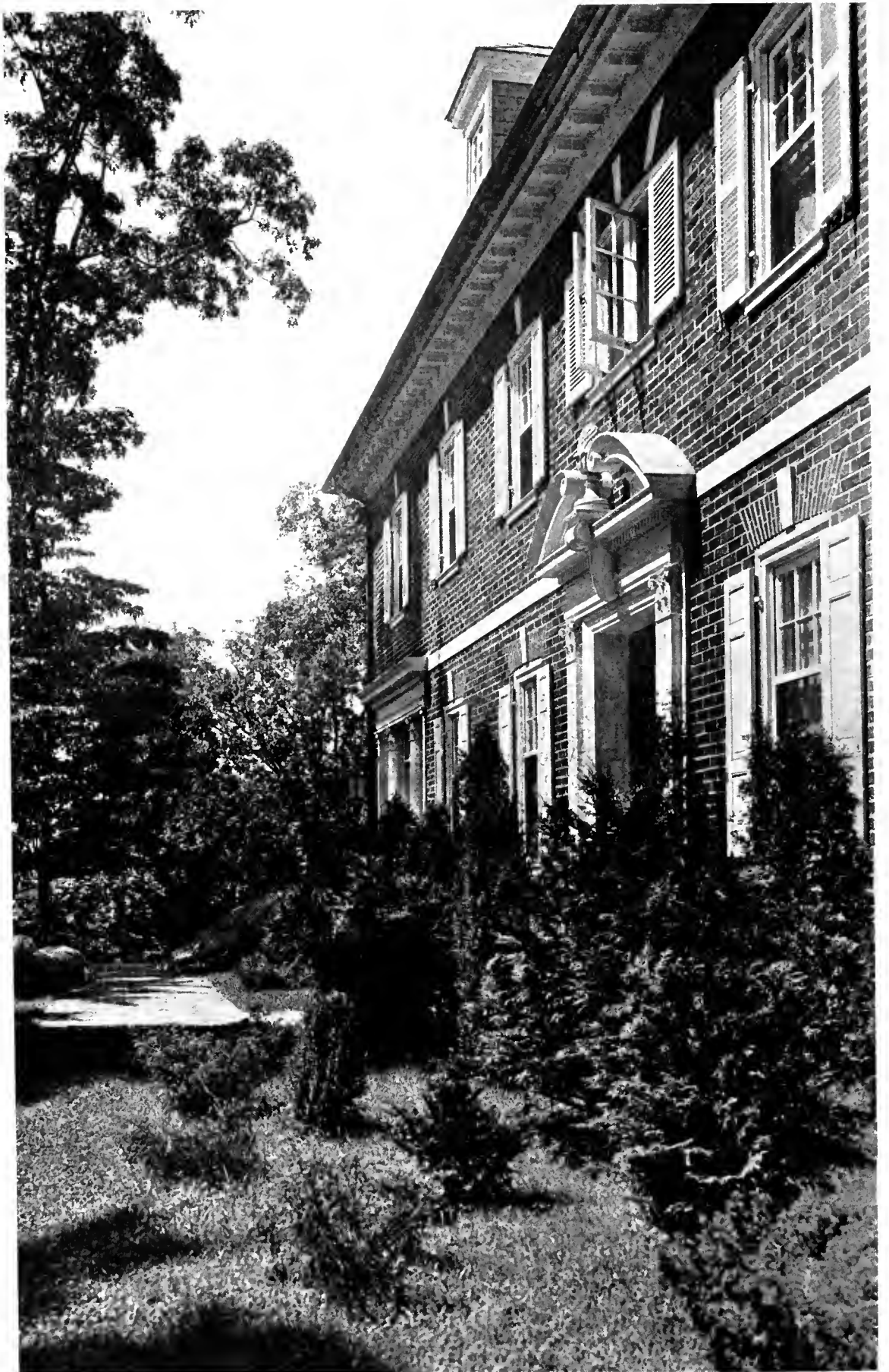

DETAIL OF MAIN ENTRANCE FRONT
HOUSE OF MR. M. A. SHEA, FIELDSTON, N. Y.
DWIGHT JAMES BAUM, ARCHITECT



HOUSE OF MR. R. E. LEWIS, HARTSDALE, N. Y.
DAWIGHT JAMES BAUM, ARCHITECT



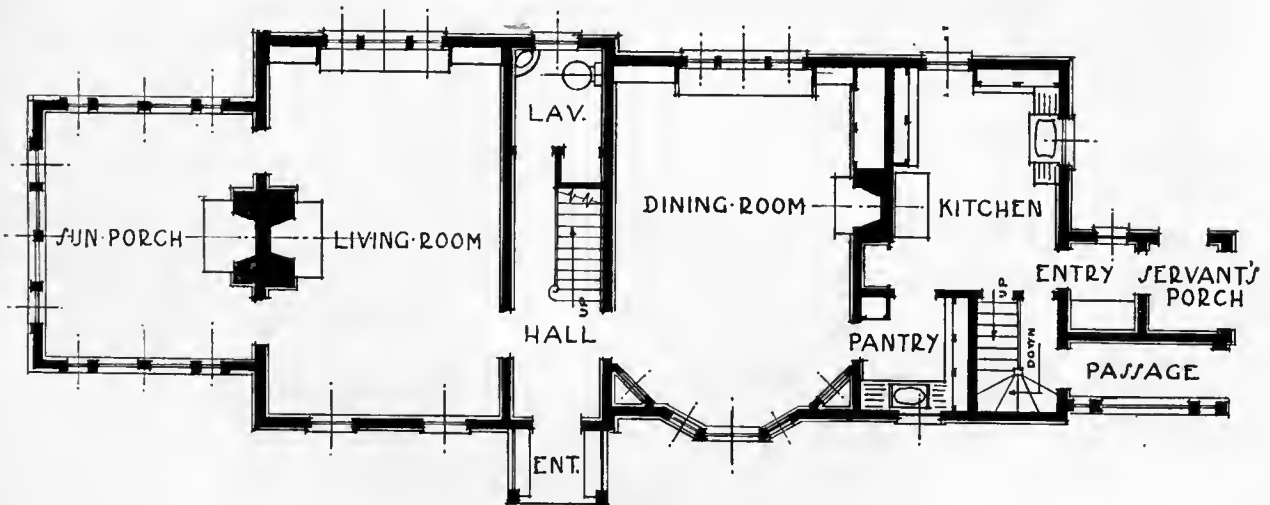
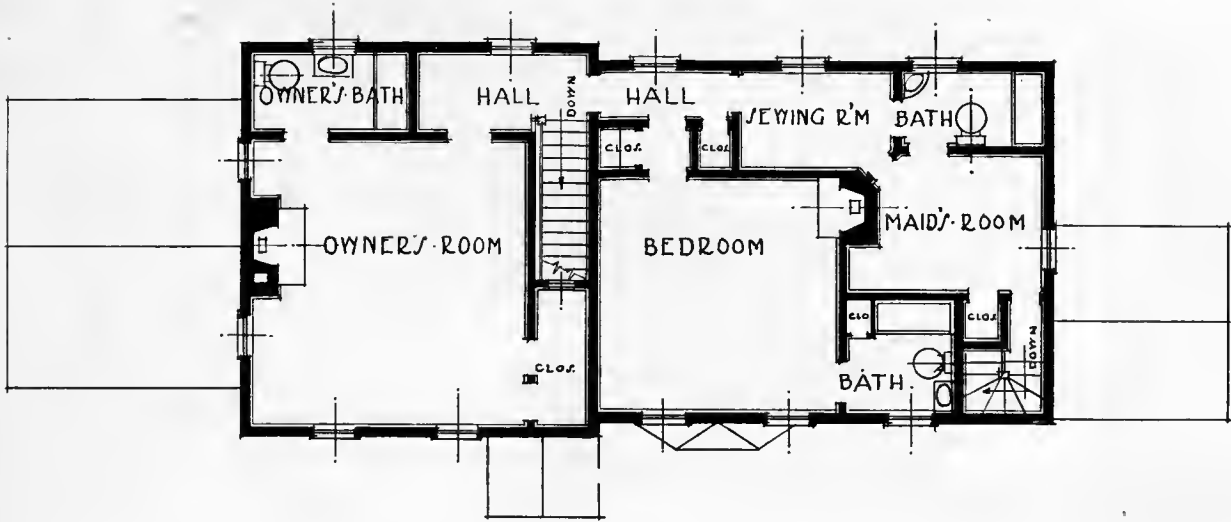

FIRST AND SECOND FLOOR PLANS

HOUSE OF MR. R. E. LEWIS, HARTSDALE, N. Y.

DWIGHT JAMES BAUM, ARCHITECT

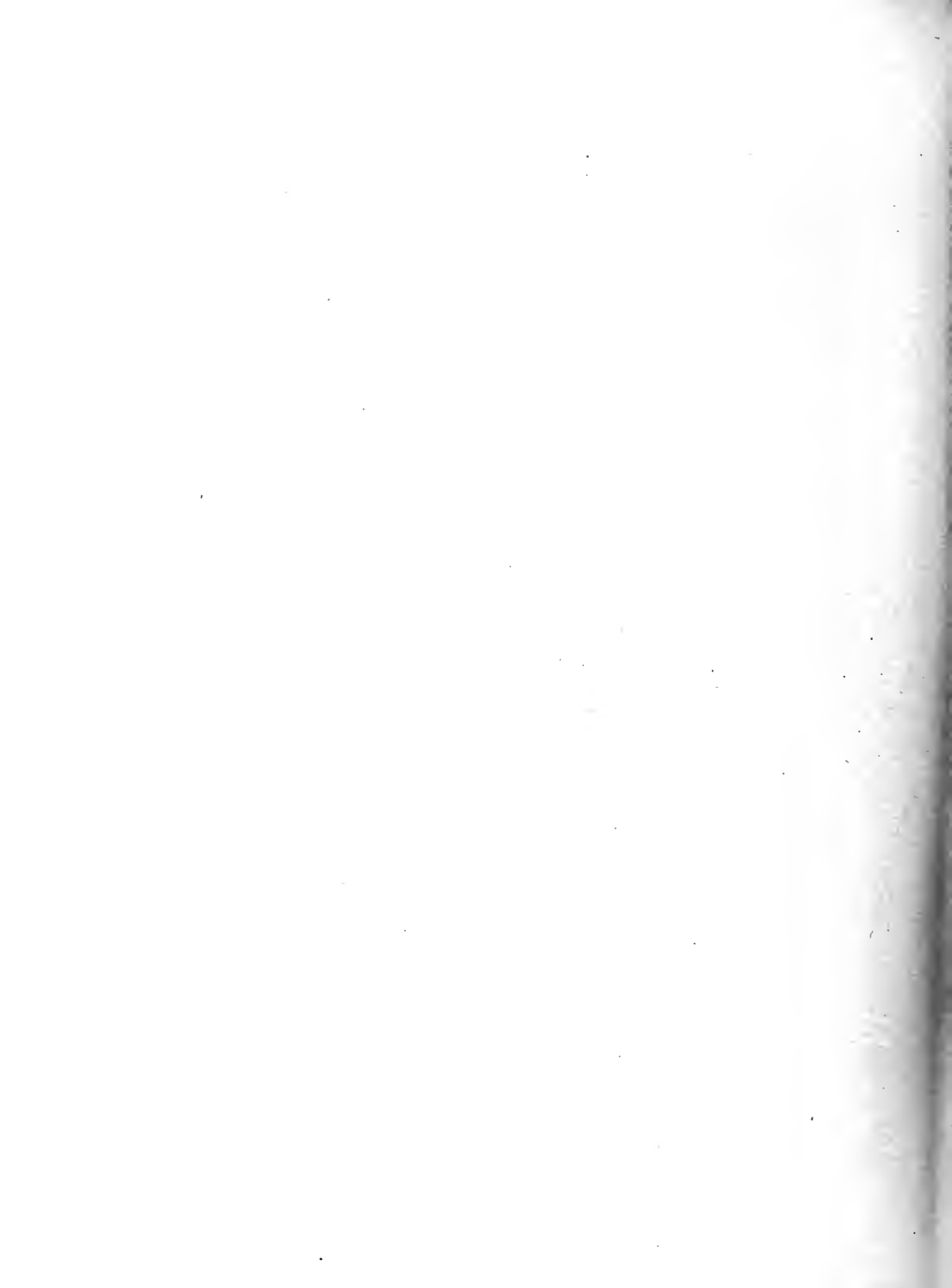



MAIN ENTRANCE

HOUSE OF MR. R. E. LEWIS, HARTSDALE, N. Y.
DWIGHT JAMES BAUM, ARCHITECT

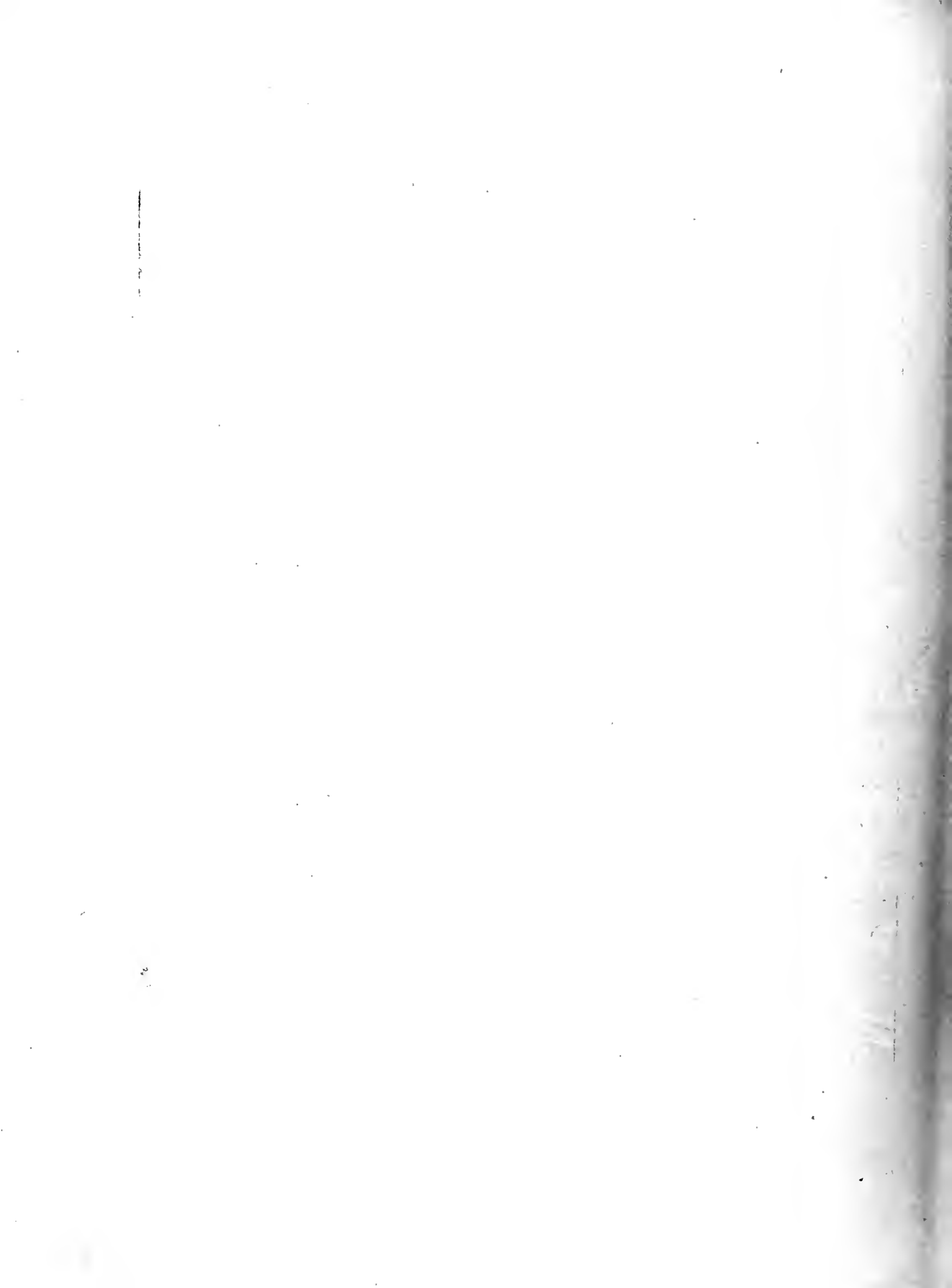



LIVING ROOM

HOUSE OF MR. R. E. LEWIS, HARTSDALE, N. Y.

DWIGHT JAMES BAUM, ARCHITECT

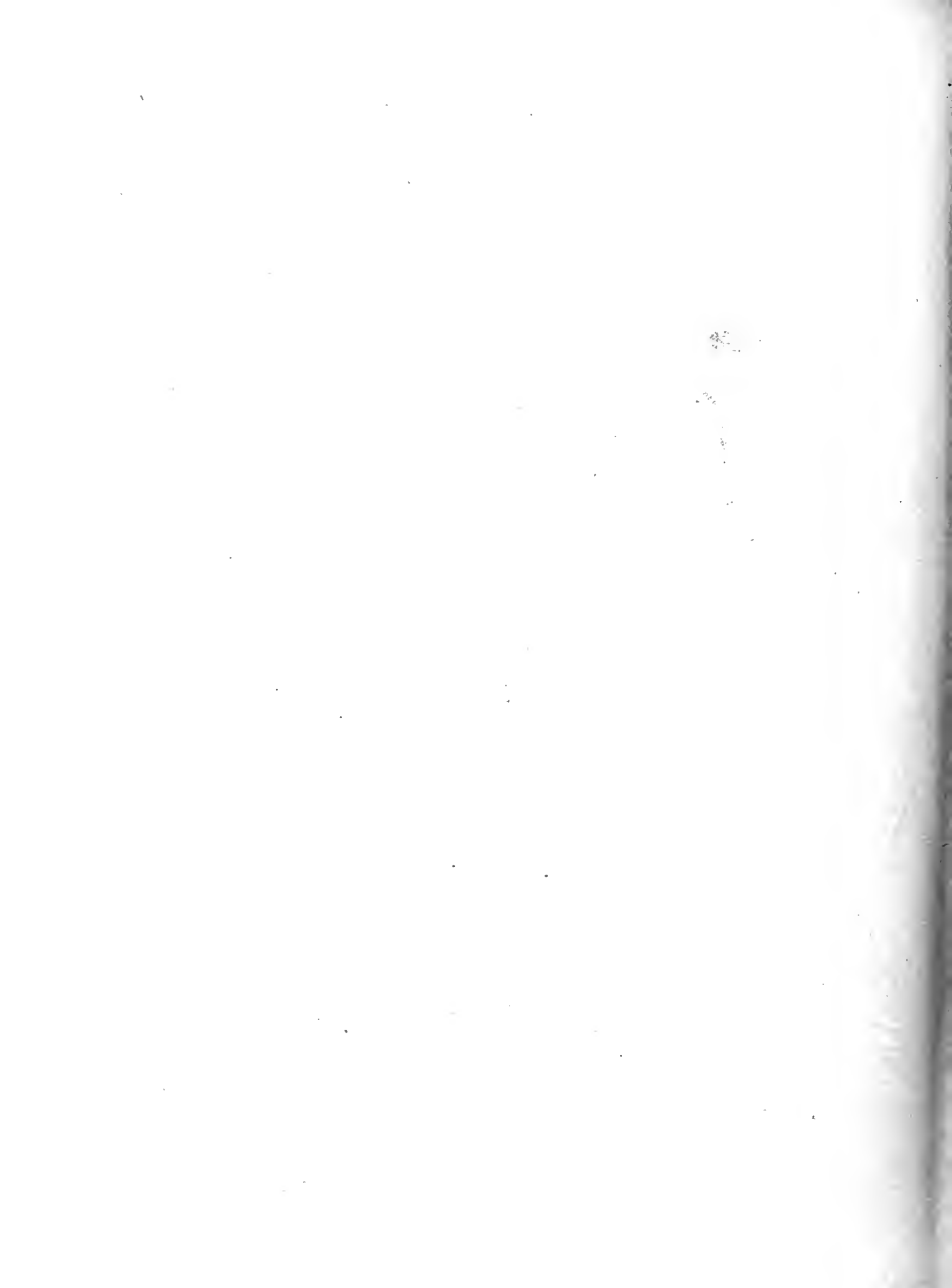



DINING ROOM
HOUSE OF MR. R. E. LEWIS, HARTSDALE, N. Y.
DWIGHT JAMES BAUM, ARCHITECT

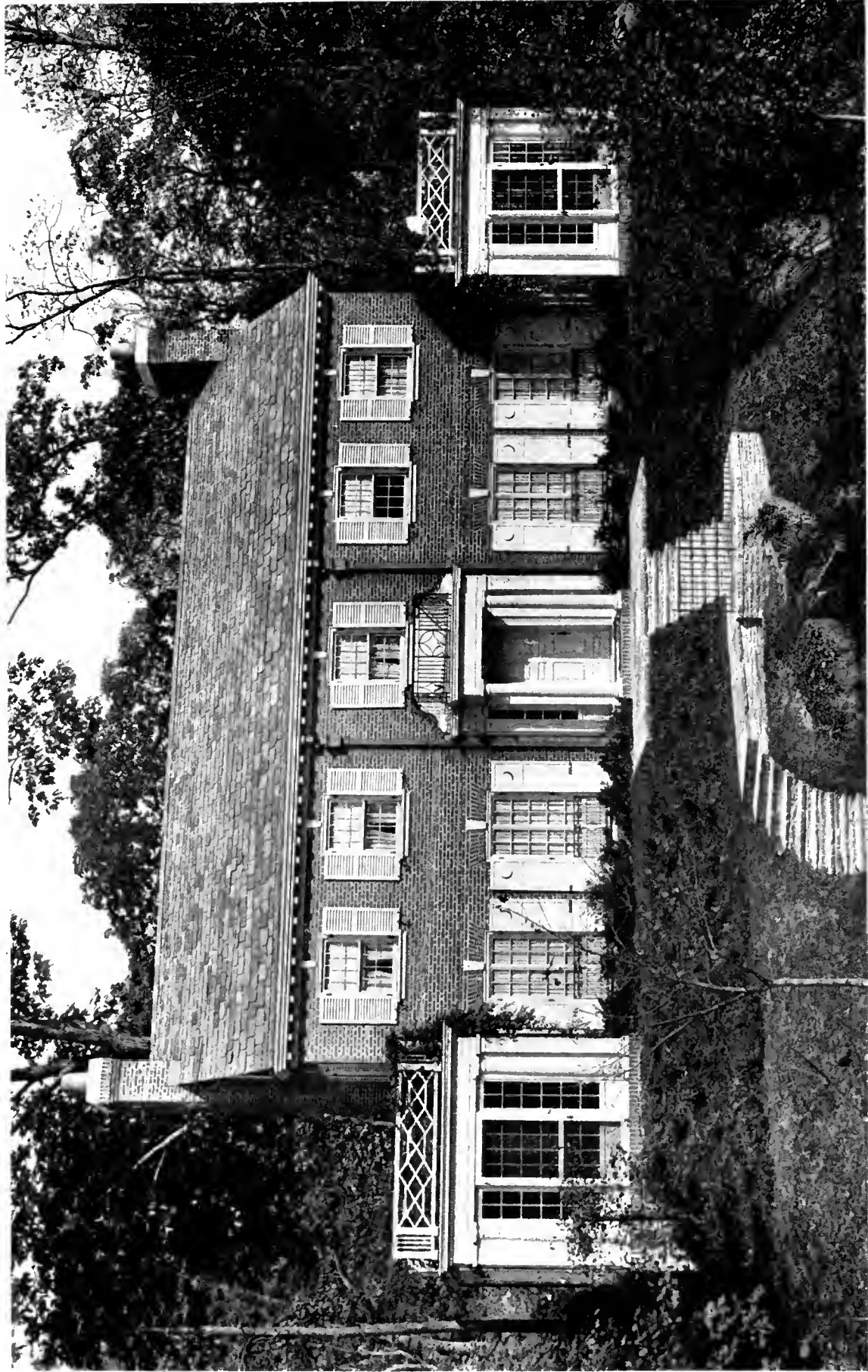

HOUSE OF MR. JOHN W. GRIFFIN, FIELDSTON, N. Y.
Dwight James Baum, Architect

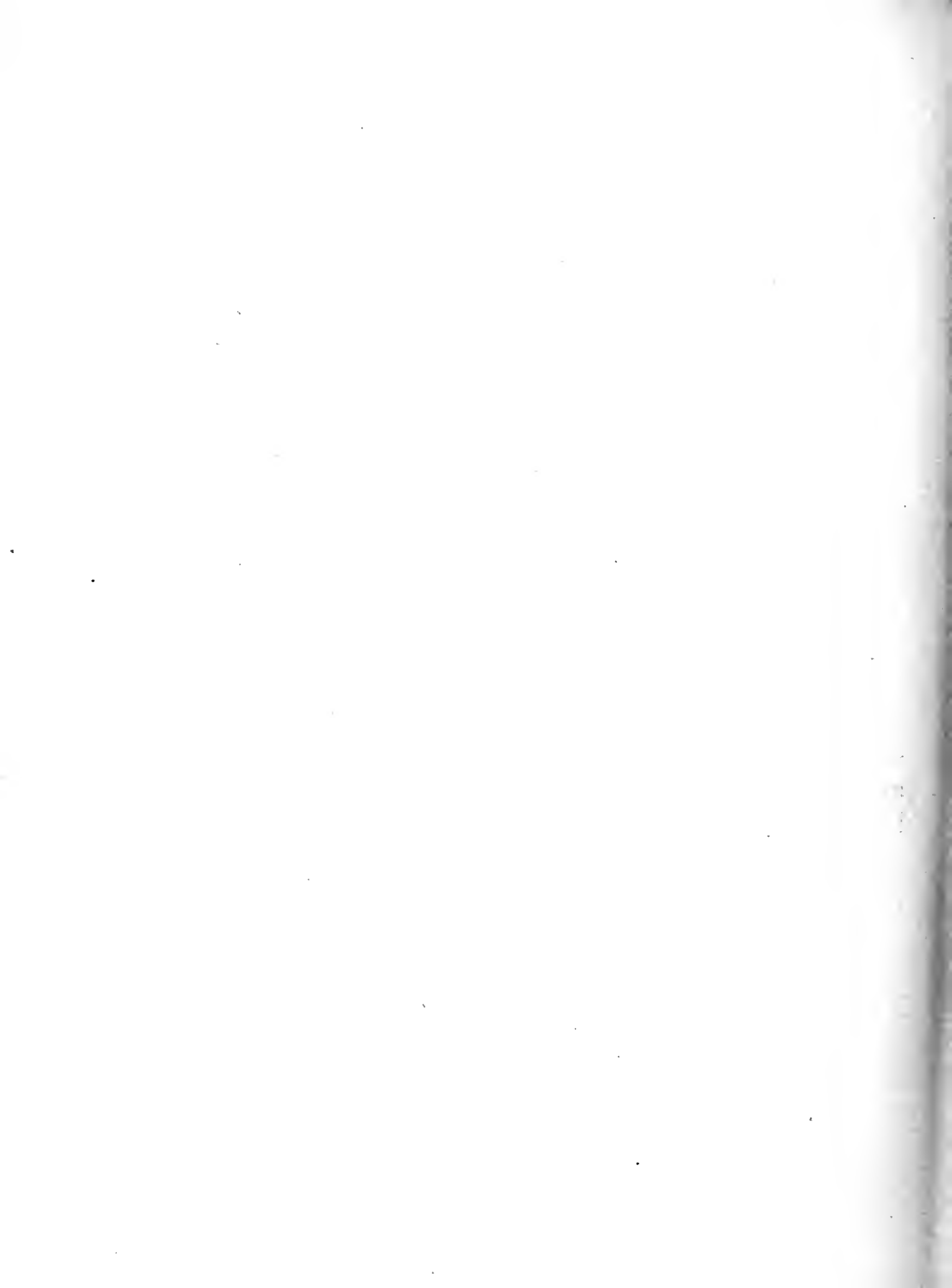

THE AMERICAN ARCHITECT

MAY 11, 1921

VOL. CXIX, No. 2367

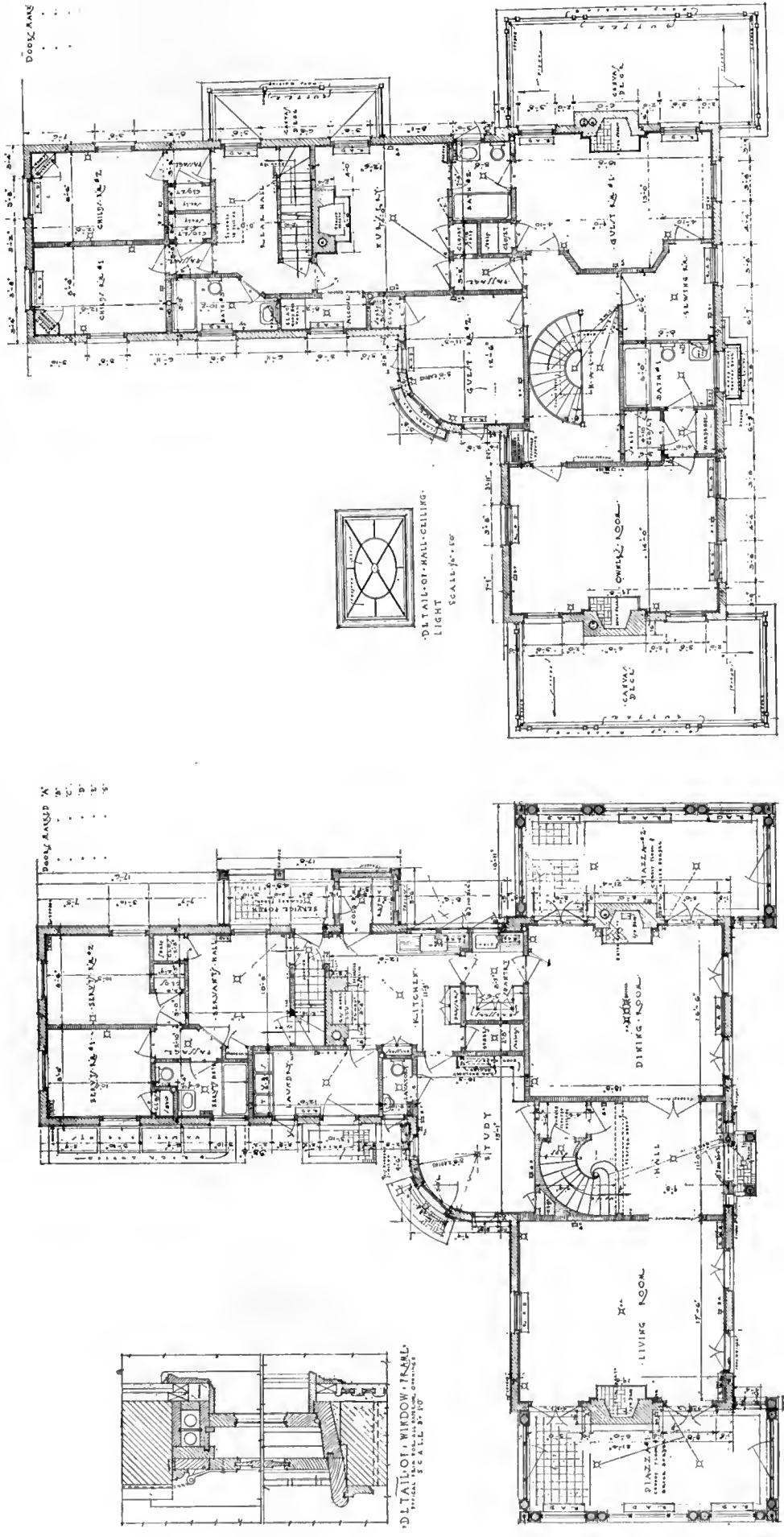

HOUSE OF MR. JOHN W. GRIFFIN, FIELDSTON, N. Y.
 DWIGHT JAMES BAUM, ARCHITECT



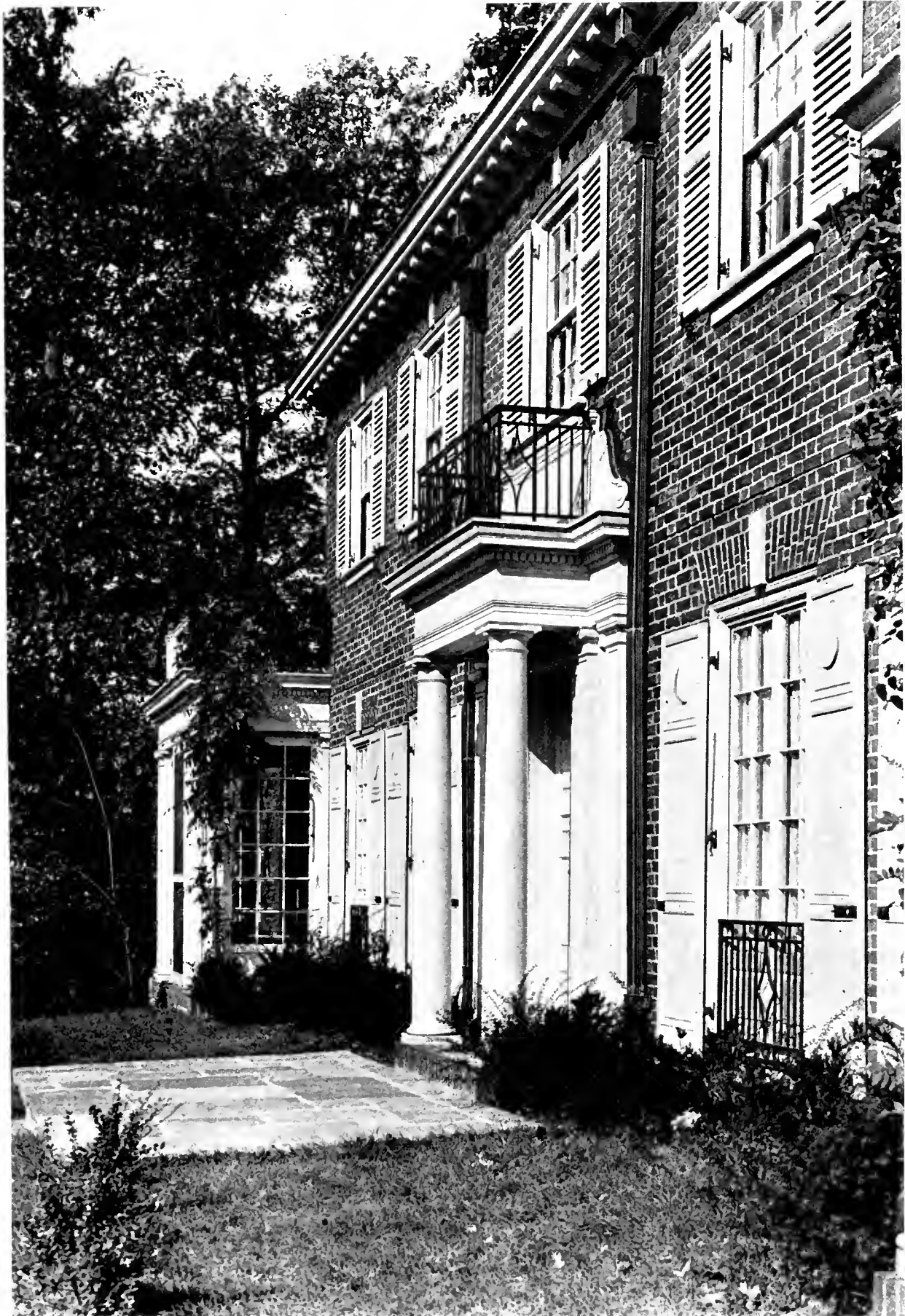

MAIN ENTRANCE
HOUSE OF MR. JOHN W. GRIFFIN, FIELDSTON, N. Y.

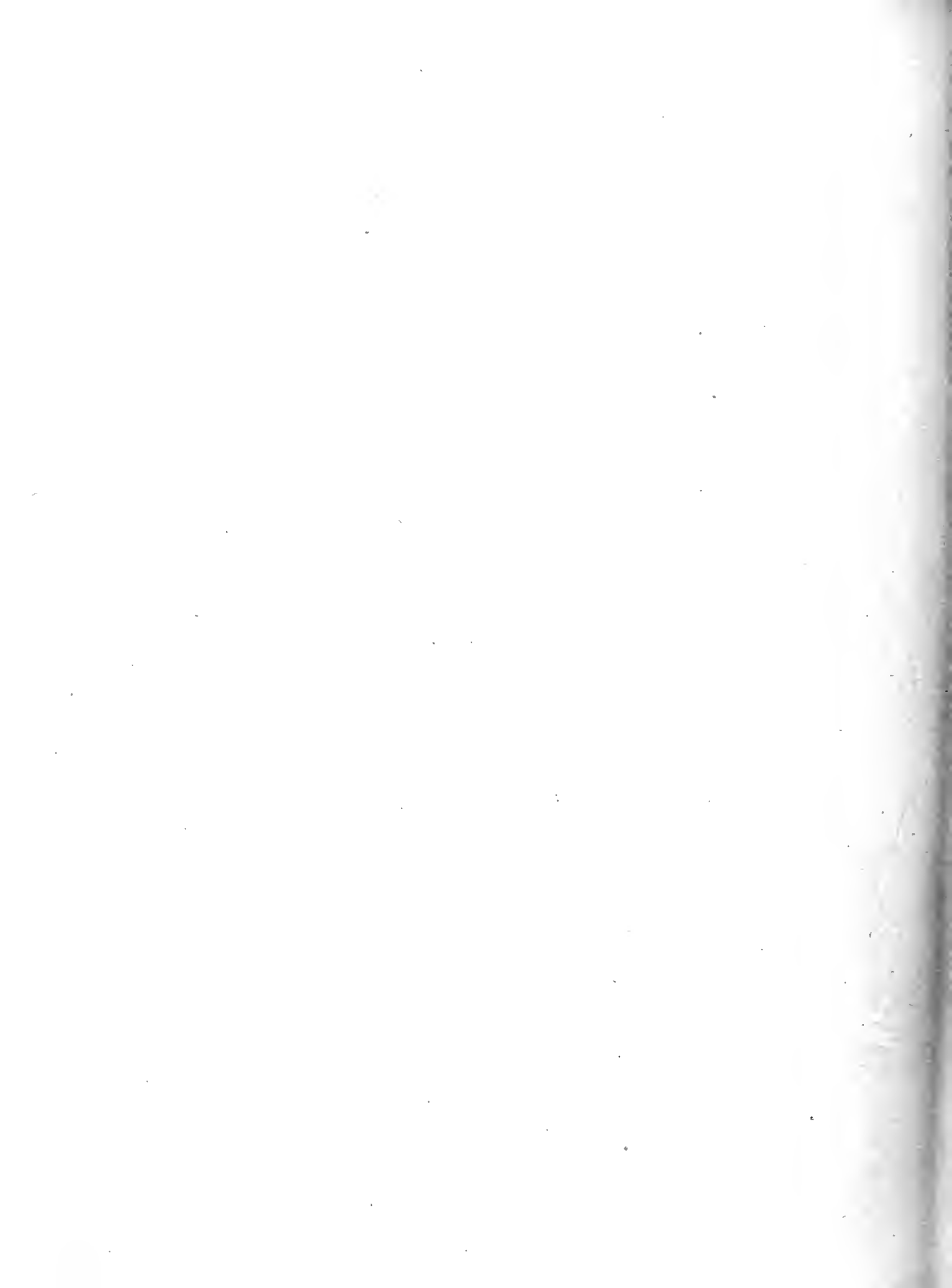



STAIRWAY
HOUSE OF MR. JOHN W. GRIFFIN, FIELDSTON, N. Y.



DINING ROOM
HOUSE OF MR. JOHN W. GRIFFIN, FIELDSTON, N. Y.
DWIGHT JAMES BAUM, ARCHITECT

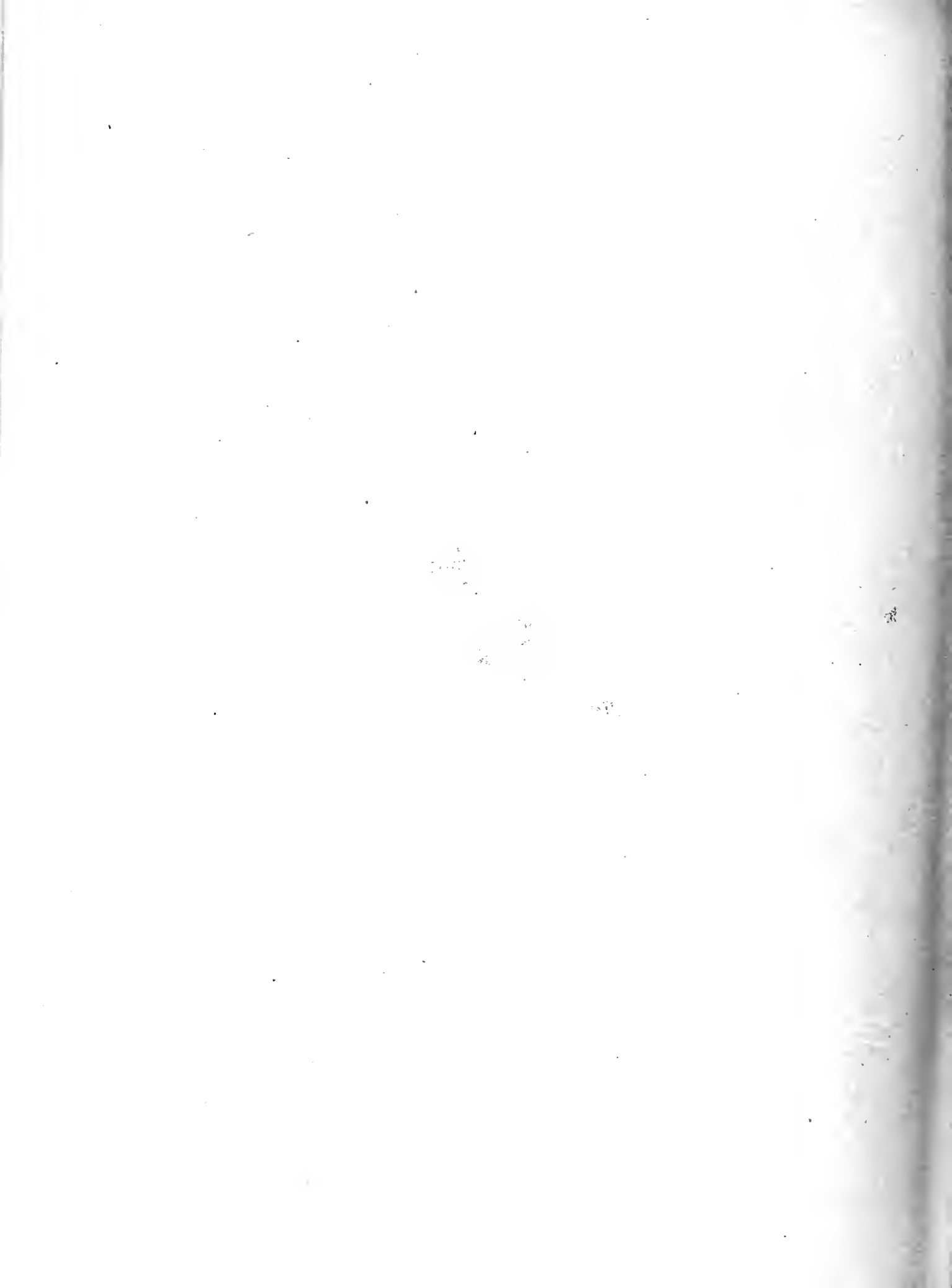



LIVING ROOM
HOUSE OF MR. JOHN W. GRIFFIN, FIELDSTON, N. Y.
DWIGHT JAMES BAUM, ARCHITECT

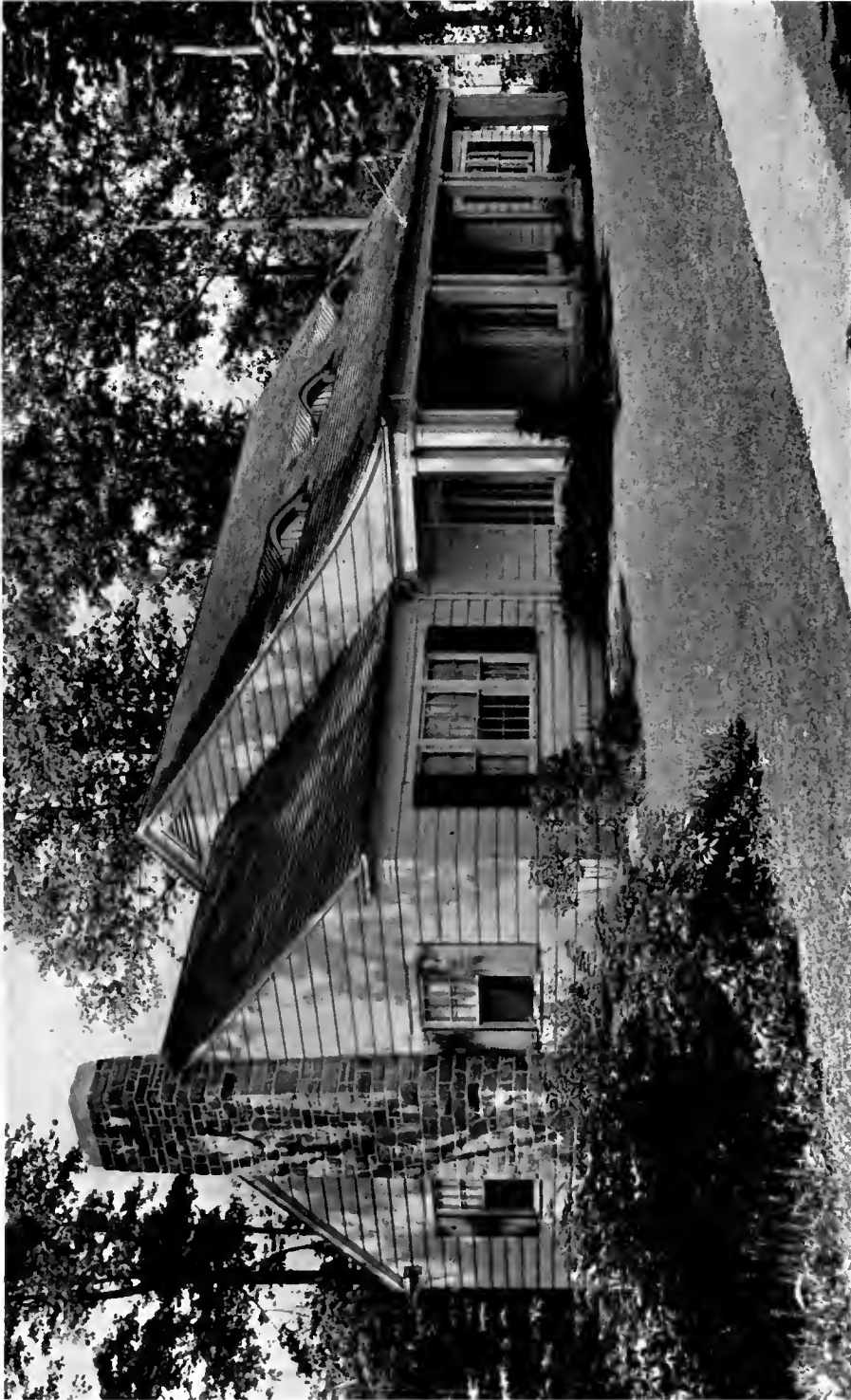

STREET VIEW
RIVERDALE COUNTRY CLUB, RIVERDALE, N. Y.
DWIGHT JAMES BAUM, ARCHITECT

b r ✓





RIVERDALE COUNTRY CLUB, RIVERDALE, N. Y.
DWIGHT JAMES BAUM, ARCHITECT



VIEW ON PORCH
RIVERDALE COUNTRY CLUB, RIVERDALE, N. Y.
DWIGHT JAMES BAUM, ARCHITECT



GREAT HALL, LOOKING TOWARD MUSIC BALCONY

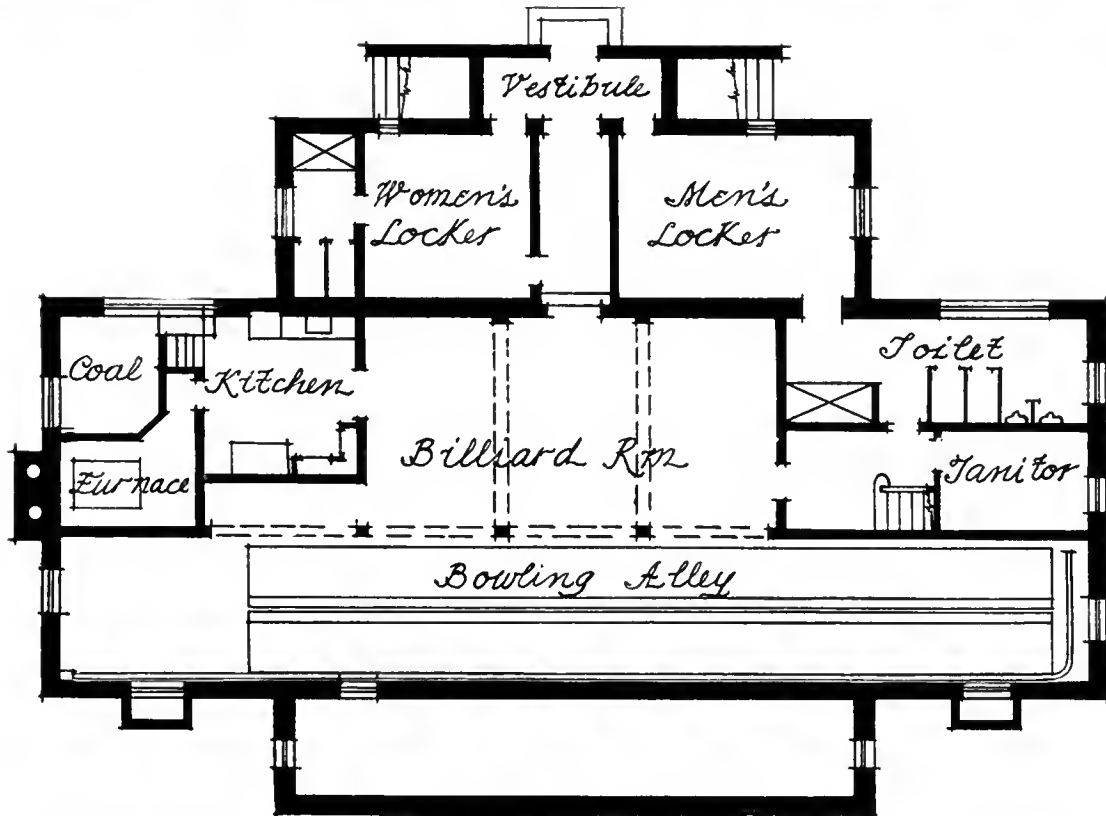

Basement Floor Plan

RIVERDALE COUNTRY CLUB, RIVERDALE, N. Y.

DWIGHT JAMES BAUM, ARCHITECT



FIREPLACE ALCOVE IN GREAT HALL

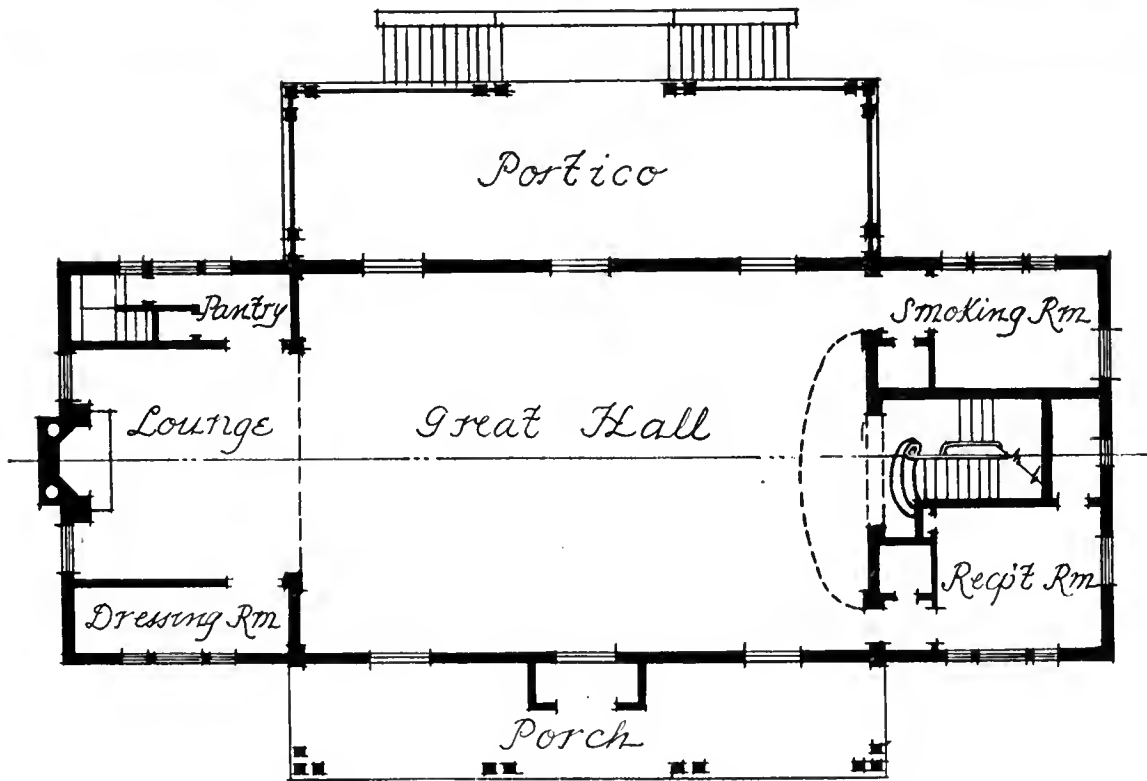

First Floor Plan



NOTES on the ILLUSTRATIONS of the WORK of DWIGHT JAMES BAUM, ARCHITECT

Riverdale Country Club

THE Riverdale Country Club was organized as a community center for a small district. Riverdale embraces a section between Van Cortlandt Park and the River in upper New York City.

The men and their wives who are interested in the various forms of charitable enterprises around New York needed a community for an organization where their various interests can be pulled together and utilized for the common good.

This site selected is in the center of the district and the building as illustrated was designed, superintended and furnished throughout under the sole direction of the architect, who was put in full charge and given no restrictions, except the hard one of keeping the entire cost at a low limit.

The building consists of a large main hall approximately 30 x 60 ft. with an entrance porch on one side and a large two-story porch on the other, facing the tennis court. One end of this great hall is an alcove approximately 20 square feet which serves as a sitting room with a large fireplace. This alcove is vaulted lower than the vaulting of the main room and forms a proscenium arch, making a stage of this unit.

On one side is a storage room for scenery, while on the other is a pantry with serving arrangements including a dumbwaiter and stairs to the kitchen below. During entertainments these two rooms also serve as dressing rooms. At the other end of the hall on the right there is a ladies' reception room and toilets, in the center is a Colonial staircase leading to the various rooms in the basement and also to the musicians' balcony. On the left end side is the men's smoking or card room.

The walls of these rooms are done in a natural gray and finish plaster. The woodwork is painted a similar tone of gray except slightly warmer. The furniture is all in the same paint, while the cushions and hangings of gray cretonnes have black figures and birds with bright plumage. The rugs are old fashioned gray rag rugs and the long tables are snapped out a little in color by the parchment shades on the lamps. The small tables, ash holders, lamps, etc., are all carried out along the same designs at very little expense, making an effective scheme.

The basement has a pair of regulation bowling alleys, a pool and billiard room for two tables, a completely equipped kitchen. There is also a janitor's room, two locker rooms and two complete toilets with showers in connection. It is arranged so that there is direct entrance from the locker rooms to the tennis courts which are practically on the same level.

House of Mr. John W. Griffin

LOCATED on West 246th Street at Fieldston in upper New York City. It is a combination of New England and Southern Georgian details done in Harvard brick with white trim and a graduated slate roof. The land was rocky and very high, making it necessary to terrace the front. Interest was added to the design by the white shutters and blinds, and the iron work was used to give some interest to an otherwise exceedingly simple design.

The house is of the central type as one enters, but it immediately departs to another type plan, has a circular staircase in the hall with an unusual arrangement on the second floor, where it comes up in the center of a square hall where a quaint appearance is obtained by the oval balustrade in this room.

There are two glass enclosed porches, one on either end and a study in the rear of the main hall which forms on the exterior, at that point, a curved bay treatment.

The Harvard brick was laid with a slightly raked out white joist in the flemish bond and the roof is of green, gray and a small percentage of a dark brown slate. This material is one (1") inch in thickness at the eaves and recedes in both size and thickness at the ridge.

The house is finished throughout in flat enamels. The floors are of oak and the bathrooms are of tile with built-in plumbing fixtures, hot water heat, etc.

Lewis House

THIS house is at Hartsdale and is built on the site of an original old farm house.

Part of the living room section was retained and the rest of the house designed to carry out the quaint Colonial character of some of the farm houses which were added to from time to time as the needs of the families called for, or as the farmers who kept them prospered. Only the simplest of materials were used and wherever any moulding or cornice remained, this was taken as a model for the new material.

The ceilings were kept very low to carry out the old farm house character and the dining room was designed to show off the many examples of Colonial glassware and china in the possession of the family.

The building was given a modern heating and plumbing system, but outside of that quaint old time characteristics were carried out. It was necessary to have an outside cellar entrance, so this was concealed behind lattice work similar to the old woodsheds throughout New England.

Shingles were used as siding as one wall of the old portion still retains the original ones. The interior mantels were studied for quaint effects and in the dining room old tiles were used.



DINING ROOM MANTEL.
HOUSE OF MR. R. E. LEWIS, HARTSDALE, N. Y.
DWIGHT JAMES BAUM, ARCHITECT
(For other illustrations of this house see plate section)

DEPARTMENT OF ARCHITECTURAL ENGINEERING



BUILDING FOR FEDERAL ELECTRIC CO., CHICAGO, ILL.
GEORGE C. NIMMONS & CO., ARCHITECTS

The FEDERAL ELECTRIC and WALKER VEHICLE PLANTS, CHICAGO

GEORGE C. NIMMONS & Co., Architects

THE new plants of the Federal Electric Company and the Walker Vehicle Company are built on a forty-acre tract of land located at 87th and South State Streets, Chicago. They were both built at the same time and designed by the same architect and they were designed as an architectural unit. There is enough variation, however, in the details of design to show that they are two distinct plants designed in the same style.

The office portions of the plants are two stories high and the factory portions are one story high. The factory portions have saw-tooth roofs, in the design of which there are some radical departures from the usual custom. The bays in the Federal Electric plant are 16 ft. by 28 ft. and in the Walker Vehicle plant 20 ft. by 30 ft., the distance between the saw-tooths being 28 ft. and 30 ft. respectively.

This spacing was especially desirable in the latter building in order to permit the assembling and driving of the electric trucks through some portions of the buildings. It is also a spacing which allows very advantageous placing of the machine tools.

In order to place the skylights this distance apart, the pitched roofs are supported by combination wood and iron trusses. The height and pitch of the glass are such that a uniform distribution and satisfactory intensity of light are secured at the working plane. Direct artificial illumination is furnished by clusters suspended from the roof and local lights in some cases, as required. The skylight glass is stationary and ventilation is secured by means of round metal ventilators placed near the high points of the roof. Line shafting is suspended from two heavy timbers attached to the lower chords of the trusses.



ENTRANCE DETAIL
BUILDING FOR WALKER VEHICLE CO., CHICAGO, ILL.
GEORGE C. NIMMONS & CO., ARCHITECTS



ENTRANCE DETAIL
BUILDING FOR FEDERAL ELECTRIC CO., CHICAGO, ILL.
GEORGE C. NIMMONS & CO., ARCHITECTS



INTERIOR VIEW

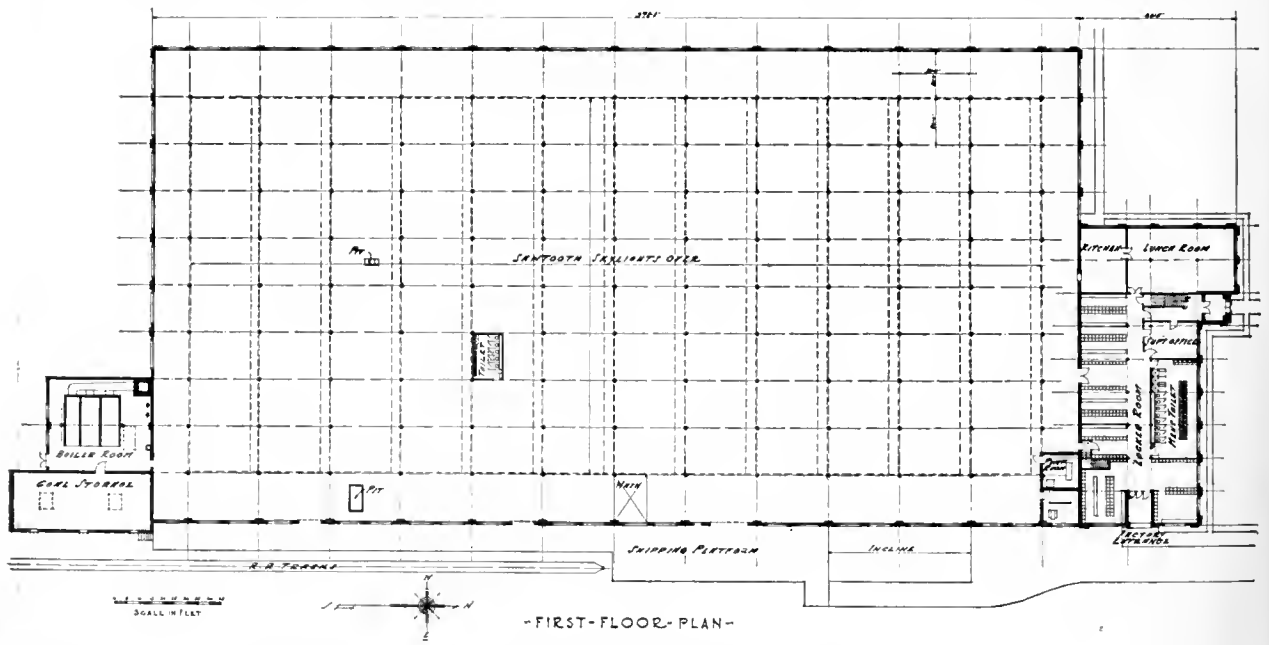

-FIRST-FLOOR-PLAN-

BUILDING FOR WALKER VEHICLE CO., CHICAGO, ILL.
GEORGE C. NIMMONS & CO., ARCHITECTS.

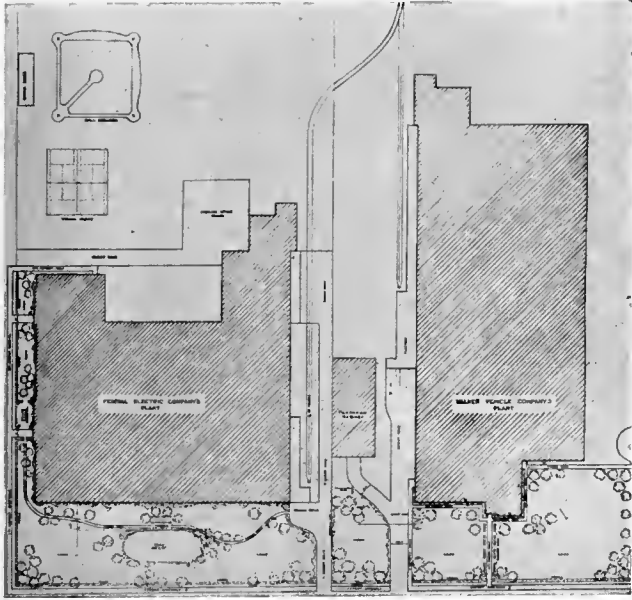

PLAN OF GROUNDS OF BUILDINGS FOR WALKER VEHICLE CO. AND FEDERAL ELECTRIC CO.

The buildings are heated throughout by direct cast iron wall radiation and the same type of radi-

ators are placed at the bottom of the saw-tooth skylights. The steam is circulated by an automatic vacuum system of heating. An automatic sprinkler system covers the entire plant and offices. The floors of the receiving, shipping, forge and assembling departments are of cement, and maple floors are used where the machines are placed and in the offices.

The buildings are placed quite a distance from 87th Street and a well-designed parking scheme is in development, a much narrower parking space is provided on the State Street frontage. When the trees have attained a considerable growth the setting will be most attractive. Baseball diamonds and tennis courts are to be provided for the employees.

The street fronts and the returns are faced with a dark red shale paving brick laid in dark mortar and sunk joints. The offsets in the buttresses are generally made with stone, but in some instances the intermediate offset is capped with brick on edge. The terra cotta panels are glazed, cream colored with light green spots and deep blue background. The sills and copings are of stone. By placing the pilasters which support the ends of the roof girders on the outside, a very pleasing effect is secured and the usual monotony of a long low wall is overcome. Such a treatment also gives an unbroken wall line on the interior and simplifies the steam pipe work. One who is interested in the designing of good

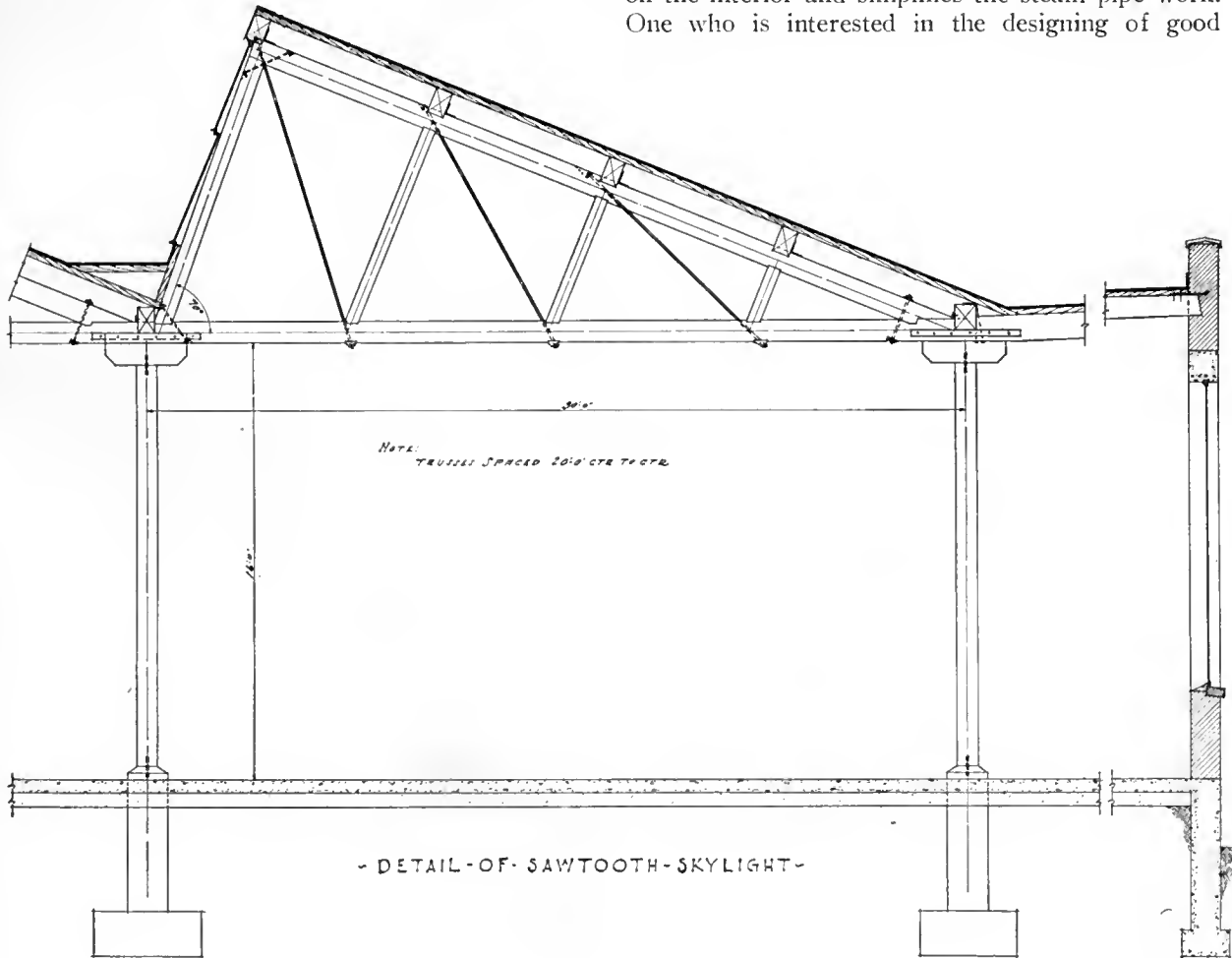

- DETAIL OF SAWTOOTH-SKYLIGHT -

THE AMERICAN ARCHITECT

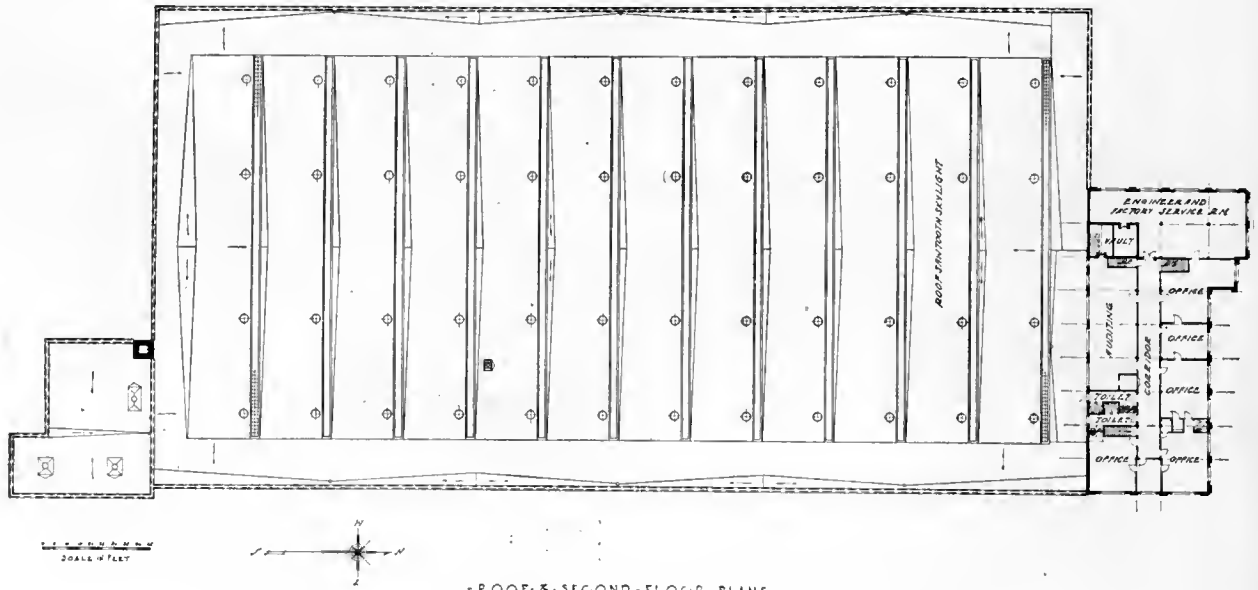

- ROOF & SECOND-FLOOR PLANS -

BUILDING FOR WALKER VEHICLE CO., CHICAGO, ILL.

brickwork will find these very valuable examples.

Mr. Nimmons was one of the pioneers in the application of good architectural designing to industrial buildings and one of the first architects who made such buildings appear to be other than what has aptly been described as "a square box shot full of holes." His work has individual characteristics de-

veloped to a high degree and is never sensational or bizarre. In addition to this, all of the structural and mechanical features of the buildings are designed within the organization. The production of the proposed output is carefully studied and the planning and arrangements developed so that efficient and economical production is assured.



VIEW FROM NORTHEAST

BUILDING FOR WALKER VEHICLE CO., CHICAGO, ILL.

GEORGE C. NIMMONS & CO., ARCHITECTS



GROUP OF HOUSES AT LANCASTER, PA., IN WHICH LINOLEUM IS USED FOR ALL FINISHED FLOORS THROUGHOUT EACH HOUSE

LINOLEUM and Its PROPER APPLICATION

IT is proposed in this article to acquaint architects with the use and adaptability of linoleum as a structural element. The use of linoleum as a flooring is, of course, widely known, but it is believed that it is not so well understood just to what considerable extent linoleum may, owing to the great advances made in its manufacture, be regarded as a floor finishing material where permanency, sanitation and the ability to withstand hard usage are essential.

Linoleum takes its name from one of its principal ingredients, linseed oil (*linum, flax and oleum, oil*). The oil is oxidized by exposure to the air until it hardens into a tough, rubber-like substance, and it is then thoroughly mixed with powdered cork, wood flour, various gums and suitable color pigments. The resulting plastic mass is pressed on burlap by means of heavy calenders. This "green" linoleum is then cured and seasoned.

There are today five principal kinds of linoleum made. They are:

(a) Plain linoleum—of solid color without pattern—the heavier grades of which are used for covering the decks of battleships, and hence are known as Battleship Linoleum.

(b) Inlaid linoleum, in which the colors of the pattern go through to the burlap. There are two kinds of inlaid—straight line inlaid and granulated inlaid.

(c) Jaspé linoleum, which may be considered a species of inlaid linoleum, since the colors run clear through the fabric. It presents an appearance somewhat like moire silk.

(d) Granite linoleum, which is also a variety of

inlaid. It has a mottled appearance, resembling terrazzo.

(e) Printed linoleum, which is simply plain linoleum with a design printed on the surface with oil paint.

Cork carpet resembles plain linoleum, but the cork used is not so finely ground, the oxidized linseed oil is softer, and the "mix" is not calendered so hard.

Linoleum, like any other product is only good when it is properly handled. And, perhaps the main retardant to the use of the heavier grades is the fact that it has been so often unskillfully employed. One



APPLYING CEMENT TO THE FELT

After the paste has set the edges of the linoleum are lifted and waterproof cement is applied to the felt as far back as the paste will permit. This insures water-tight joints.

THE AMERICAN ARCHITECT

correct manner of laying linoleum over rough wood or concrete bases is to paste it down over a layer of heavy felt paper and seal the joints with waterproof cement. It is in improper jointing that linoleum has at times not been satisfactory. The same skill of practice or knowledge that a man must have in laying a wood floor is necessary when linoleum is used, and no more. It is a grave mistake to suppose that because linoleum is laid in broad areas and with few joints that the accuracy of this jointing may be slurred. Moisture beneath a wood floor will create



CUTTING JOINTS AND MATCHING SEAMS

Both overlapping seams are cut through at the same time. A perfect joint results. Seams fitted in this way are almost invisible.

the same bad effects as it will beneath the linoleum floor. Good craftsmanship and a proper knowledge of how to handle linoleum is every bit, and no more necessary than in other materials.

The advantages of the felt underlayer are strongly urged by the manufacturers. The use of felt, it has been found, increases the life of the linoleum, makes an elastic floor surface and, therefore, easy to walk on. It serves as a deadener of sound and it makes a much warmer floor in winter and cooler in summer. It prevents bulging due to expansion, and when the felt is thoroughly pasted to the linoleum, also prevents contraction. Further, in case of repairs beneath the floor, the linoleum can be readily removed without damaging it.

The preliminary condition of the under floor where linoleum is to be laid is of the utmost importance. If laid on a wood base, it should be well dried and seasoned, the surface smooth, all cracks filled and any protruding knots or nails smoothed down. Similar precautions must be taken when laying on a concrete base. New concrete floors are never sufficiently dry in less than three or four months from time of

laying, depending on seasons and the state of weather. Moisture on the underfloor neutralizes the cement, and sets up mildew. It is particularly recommended when linoleum is laid in basements, which are seldom sufficiently dry to avoid moisture, that the floor be waterproofed.

It naturally follows that it is necessary to have the felt foundation for the linoleum perfectly dry. It should be allowed to stand a sufficient length of time to accomplish this, which will be in normal conditions from eight to twelve hours. It is essential that the felt undersurface should be as carefully laid and fitted as the linoleum itself. The edges should be carefully "butted," else ridges will occur. Seams should fit closely and neatly, particularly around any built-in furniture, radiator feet, pipes, etc., thus insuring a good job.

Briefly described, the proper way to lay linoleum is to begin at the wall. The material is pressed closely to the wall and cut with a special knife to fit every contour. In fitting around pipes or other projections, the linoleum should be cut neatly from the nearest edge of the piece, along a straight line, and just enough material should be removed to insure a snug and perfect fit. It is in this cutting and accurate fitting, which should receive careful attention, that the long life of the linoleum is assured.

The correct method of applying the paste and of



ROLLING THE LINOLEUM

The use of the roller secures good adhesion and makes the seams practically invisible.

THE AMERICAN ARCHITECT

cutting and fitting the linoleum is shown in the accompanying illustrations and captions.

Undoubtedly prejudice against the use of linoleum, if any well formed prejudice exists, is due to ignorance of the great advance made in its manufacture. The earlier form of light weight, surface printed linoleum has given place to a heavier sort, and one where the colors go clear through and are thus permanent and brilliant during the entire life of the floor. Further, there has been brought to the production of linoleum all the resources of good art, with the consequent appreciation of good color, until today one may have linoleum floors that vie in attractiveness of good surface and fine color with the early type of hardwood floors covered with Eastern rugs, and give a most pleasing effect.

That this is no exaggerated statement can be proven in a most unusual manner. Seldom will manufacturers have opportunity to place their product in actual use, at all times under their observation.

One of the largest of the companies now producing linoleum has its plant at Lancaster, Pa. This plant covers a large area and provides the most excellent modern housing facilities for officers and their families.

In this section where reside the officers of this company, a group of modern houses has been erected. Every one of these houses in all of their rooms, has rough underfloors on which linoleum is laid as a finished flooring material. These floors receive all the hard usage in the rooms devoted to the domestic routine and in the more formal rooms of the

house, the floors are laid in colors and patterns which very effectively carry forward a certain well considered decorative scheme.

There is to be found an undoubtedly practical demonstration as to the use of linoleum. Its adaptability of laying on all sorts and intricacies of floor planning, its durability and what is so often ignored when linoleum is considered, its artistic possibilities.

And it is the subject of artistic adaptability that may be considered before closing this article. The wide range of colors and sizes of patterns permits the use of linoleum in every room in the house. The sense of scale or size of a room may be preserved and even accented by the choice of the size of the pattern. The color scheme can, in the same consistent manner, be carried forward. In fact, if the home dweller will cast aside prejudice where any exists and cover his floors with linoleum, he may find, no matter how highly developed is his artistic taste, that it will not be affronted. He will have floors that are warm and airtight. Floors that are resilient, over which small children may play and fall with safety. And, with this non-absorbent surface he will have a floor as sanitary, as easily cleanable as any that can be laid. Furthermore they will not require refinishing from year to year.

Of course, these advantages in the home are equally desirable in any structure, whether it be the unstable platform of a battleship, driven head-on into the teeth of a gale, or in the aisle of a church where the belated worshipper may noiselessly find his pew without disturbing the entire congregation.



DINING ROOM FLOOR IN HOUSE IN LANCASTER, PA., LAID WITH LINOLEUM. NOTE THE RUGS, SPREAD IN USUAL WAY AS ON WOOD FLOORS

THE AMERICAN ARCHITECT

Comfort, particularly on a floor used for business or where workers have to be on their feet for long periods, is essential. Because of its resiliency, linoleum insures this desirable condition.

Durability, the essential feature of economy in any floor, is served by linoleum. As the material has no grain, it cannot splinter, and since it is elastic, it is not liable to crack, crumble or "sand" as do other types of floors.

The also important feature of a sanitary floor-covering is absolutely provided by linoleum. Being seamless and non-absorbent, it is perfectly sanitary.

Ease in cleaning is naturally better served because of the large area of the floor free from cracks.

While linoleum is not fireproof it will be easily

understood, that used in place of wood floors, it largely decreases the volume of combustible material required for flooring purposes, especially since wooden sleepers, which must be imbedded in the concrete slabs where wood floors are to be laid, are not required to hold linoleum in place.

That linoleum is easy to install has been clearly shown by the foregoing description of method and the accompanying illustrations.

It would, therefore, appear in view of all the facts that there is economy in the use of linoleum as a floorcovering and that with this desirable feature are combined many others that are considered essential to floors in whatever location or under any of the varying conditions that may be present.

CURRENT NEWS

Happenings and Comments in the Field of Architecture and the Allied Arts

A Fine Exchange of Unselfish Recognition

AS an aftermath of the celebration of the thirtieth anniversary of the founding of the University School of Architecture recently held in the handsome new Alfred C. Harrison Hall amid most appropriate ceremonies, I am told by a friend who was present that there was a very charming incident, much to the credit of all concerned, states a correspondent to the Philadelphia *Ledger*.

When the French delegate from the "Société des Architectes Diplomes" handed to the Provost of the University, with the usual flattering remarks, the medal which had been awarded by the French architects to the school the Provost handed it to Prof. Warren P. Laird, who has been its soul, as well as its head, and has brought it to the point when it has been made worthy of the distinction from a foreign nation.

Prof. Laird, with perhaps exaggerated modesty but with what the French would describe as a *beau geste*, turned to Prof. Paul Cret and handed the medal to him.

It is not often that heads of institutions are so ready to recognize the men who, in less conspicuous positions than their own, have borne the burden of the day; but while fully recognizing all that Dr. Cret has meant to the School of Architecture of the University of Pennsylvania, one likes to feel that all appreciate the splendid work done by Prof. Laird, whose monument is the school itself and who has surrounded himself with such men as Dr. Cret, who have cast luster upon the work.

Summer Classes in Architecture

University of Michigan College of Architecture Announces Summer Session

BEGINNING July 5 and extending through to August 26, the University of Michigan will conduct classes in architectural design, freehand and instrumental drawing, painting and also an art teachers' course. This work will be under the direction of the College of Architecture and will afford an opportunity for those whose work or circumstances prevent taking the regular courses, to obtain instruction that should prove of great value to them.

The fall semester begins September 27.

A Correction

IN our issue of April 27, page 539, an error of tabulation occurs. In the second and third items from the bottom of the page, the entries in the three right-hand columns were interchanged. The residence at Portland, Me., contained 80,352 cubic feet and cost \$43,634, or .543 per cubic foot. The residence at Birmingham, Ala., contained 38,688 cubic feet and cost \$5,000, or .129 per cubic foot.

New York Society of Architects

MANY matters of City and State wide importance were discussed at the April meeting. A keen interest marked the proceedings throughout.

The eleventh issue of the Society's Year Book was reported in process of circulation among the architects of the City and State. Each member of the profession receives gratis a copy of this valuable

THE AMERICAN ARCHITECT

handbook which is recognized as a standard work of reference for practising architects.

Among the matters discussed were the Post Office Regulations controlling the installation of mail chutes in business buildings. It was urged that these regulations be modified to meet the requirements of various types and sizes of buildings.

Strong comment was aroused by the practice which still obtains of employing inexperienced men lacking essential qualifications as architects of important buildings. One such instance was mentioned in which a public schoolhouse in an outlying town not far from New York City was recently entrusted to a mere tyro in the profession. Moreover, cases are reported in which men in the employ of the City are surreptitiously and in violation of the law practising as architects.

The Committee of City Departments reported progress on the bill of Supt. Miller for the restraint of unauthorized practitioners which the Committee is taking up with Mr. Miller.

Architects Elect New Officers

THE Reading (Pa.) Architectural Society elected the following officers at a recent meeting: President, Charles H. Muhlenberg; vice-president, Claude B. Mengel; secretary-treasurer, Harry Maurer; directors, Miles M. Dechant and Raymond J. Richardson.

Head of Armour Institute of Technology

HOWARD M. RAYMOND has been appointed acting president of the Armour Institute of Technology, Chicago, to fill temporarily the vacancy caused by the recent death of Dr. F. W. Gunsaulus. Acting President Raymond has been connected with the institute for the past twenty-six years, serving as Dean of Engineering since 1903.

Kansas City Architects Announce New Service Bureau

Designs and Supervision for Houses Costing \$6,000 and Less Will Be Available at Nominal Cost

KANSAS CITY, Mo., architects are organizing to aid the small home builder in the solution of the problem of the family that has less than \$6,000 for a house.

These architects will seek to design compact, economical, but architecturally attractive houses of six rooms and less.

The Architect's Small House Service Bureau of Kansas City will consist of members of the Kansas City chapter of the American Institute of Architects, but will be open to any recognized architect of this section. The tentative officers are Ernest O. Brostrom, chairman; A. S. Keene, vice-chairman; A. W. Archer, secretary, and W. W. Rose, treasurer.

The organization is expected to be complete in the very near future.

The bureau will be self-supporting, deriving its income from a nominal fee, to vary from \$18 to \$32 a house. The patron of the bureau will receive complete plans and specifications of the design chosen, a quantity survey on which to figure costs, advice as to contractors and supervision. Architects probably will contribute about \$100 each to finance the bureau, receiving on this an 8 per cent. annual return. Any earning above that will be spent in research in the interests of better and more economical design and construction.

Many prominent architectural firms of Kansas City and vicinity have already definitely affiliated themselves with the bureau.

National Memorials Committee Issues Warning

THE National Committee of Memorials does a public service, states the *detroit Free Press* editorially, when it suggests to the American Legion and to all others interested in the subject that they beware of memorial projects fostered by commercial interests, and asks that posts and departments of the legion withhold their approval of any memorial project until all the plans, financial and otherwise, are submitted to national headquarters. Memorials of the Civil War were erected all over the country; usually in the form of small monuments. There are still evidences of sincere patriotism, but, unfortunately, the evidences of bad taste which many bear sometimes speak also with loud voice. There has been no tendency since the Great War to follow the Civil War example in the erection of innumerable small commercial monuments, but the fact that so many mistakes were made half a century ago is indication that mistakes may still be made. Careful deliberation and expert advice are needed upon every memorial project, because such work is done for the centuries and must stand severe tests of time and criticism.

Information Bureau for New York State Contractors

IN order to supply complete information to contractors for all New York state departments, the American Surety Company of New York has opened a State Surety Bond Bureau at 148 State street, Albany. The service of this bureau will be to furnish, without cost to its clients, accurate contract news from every department as soon as the information is made available to the public.

The State Surety Bond Bureau will be under the direction of Farrington Smith. The work will be comprehensive, covering not only construction work but also supplies of every kind. Some of the services of the bureau will be daily bulletins containing notices of all state calls for bids on purchases, sales and construction work; the furnishing of bidding blanks and specifications to all contractors interested; telegraphic notice of bid openings and awards; filing

THE AMERICAN ARCHITECT

of bid papers; reporting of bid openings, with prices.

The office of the bureau will be entirely distinct from the Albany branch of the American Surety Company, which is located at 100 State street.

Historic St. Paul's, in Washington, D. C., Destroyed by Fire

OLDER than the District of Columbia, and a relic of the revolutionary days, St. Paul's parish church, in Rock Creek cemetery, was recently destroyed by fire with priceless records of early Washington history. All that remains of the historic edifice are the four walls, erected in 1776. The cause of the fire is unknown.

St. Paul's church was preceded in 1719 by a frame chapel, of which the Rev. John Frazier was rector. The Rev. George Murdock, who was inducted by Charles Calvert, governor of Maryland, in 1727, was the first incumbent. He served 34 years and died in 1761.

"A National Landmark"

THE New Technology, the home of the Massachusetts Institute of Technology, is well named by Stone & Webster, the builders, the National Landmark. Located on the Cambridge embankment of the Charles River, this splendid group has through the efforts of its architects and builders, slowly

grown until it today stands a well completed work. When one scans the pages of a monograph, issued by Stone & Webster, the mechanical excellence of which is beyond criticism, it will be seen how pardonable is the builders' pride in their work, and how modestly they express that pride in the illustrated book they have so very cleverly prepared.

It is in such complete accord between architects and builders that we may hope for the further continuance of our architectural development. It is not alone in the perfection of detail of a builder's organization that such excellence of performance is achieved. It is because the builder is becoming more and more a higher and better craftsman and because he is bringing to his tasks all the elements of good art that architects bring to theirs. When all builders in this country realize how essential it is to develop this fine spirit of co-operation and efficiency, we shall have further "National Landmarks" that by the splendid lessons which their forms inspire will hasten the attainment of a better Americanization.

We infer that this excellent monograph on the New Technology will be available to architects and we believe they will find its possession a valuable addition to their working library. Stone & Webster of Boston are to be congratulated on having made a fine contribution to the literature of our architectural progress, in this finely prepared illustration of a well-executed group of buildings.

PERSONALS

Franklin J. Carlisle, architect, 452 West Federal Street, Youngstown, Ohio, desires manufacturers' latest catalogs and specifications to complete his files.

Kemper Nomland, architect, has moved his offices from 312 to 317 Southwest National Bank Building, Oklahoma City, Oklahoma.

Ross Love Henderson, architect, announces the opening of an office for the practice of architecture at 740-742 David Whitney Building Detroit, Michigan.

George Bain Cummings, architect, formerly of Lacey, Schenck & Cummings, will continue the practice of architecture under his name, with offices at 602-604 Security Mutual Building, Binghamton, N. Y.

William Alciphron Boring, architect; Edward Lippincott Tilton, architect; Ernest Greene, architect, and Boring & Tilton, architects, announce the removal of their offices from 52 Vanderbilt Avenue to their new building at 141 East Forty-fifth Street, New York City.

Wm. H. McKay begs to announce the opening of a new office and studio at 179 West Rock Avenue, New Haven, Conn., for the practice of architecture. Manufacturers' catalogues and samples are requested.

Charles H. Alden, architect, announces the removal of his offices to 358 Empire Building, Seattle, Wash.

Announcement is made that John F. Jackson, architect, has moved his office to 1819 Broadway, New York City.

Elmer E. Green, architect, has resumed his practice and has reopened offices in the Arcade Building, Seattle, Wash., for the general practice of architecture.

The office of John Russell Pope, architect, has been removed to 17 West Forty-sixth street, New York City.

Roy Seldon C. Price, architect, has moved from 1705-1707 Arcade Building, St. Louis, Mo., to 2622 San Marino street, Los Angeles, Cal.

THE AMERICAN ARCHITECT

THE BUILDING SITUATION in the MIDDLE WEST

(Special Correspondence to THE AMERICAN ARCHITECT)

CHICAGO.—The long-expected showdown between building contractors and union building labor has arrived. The dispute over the proposed wage reduction has been brought to a focus by an announcement on the part of the contractors that all building now in progress will be brought to a standstill. It is possible that the matter may be adjusted by mutual concession before this review reaches print, but such an early settlement of the dispute is not expected by contractors, unions or the general public. Rather a long-drawn-out contest is the expected course of the difficulty.

As previously reported in these columns, the present impasse results from a determination on the part of building contractors that the public should not be asked to pay as much for union labor as during the war period. Acting upon this assumption, a wage reduction was proposed which would cut the pay of skilled labor in the building trades from \$1.25 per hour to \$1.00 and the pay of unskilled workmen from \$1.00 per hour to 70 cts. per hour. The suggestion at first indignantly rejected by the business agents and officials of the unions was later submitted by referendum vote to the union members and in the case of practically every union in the Building Trades Council was rejected by a very large majority. Counter proposals of arbitration were rejected by the associations of contractors and the lockout order followed.

If the firmness of the respective sides continues, the present small volume of building in Chicago will be virtually paralyzed. One of the large items of construction upon which work will be stopped is the Federal Reserve Bank Building on which steel construction is now in progress.

On the other hand, if the present dispute leads to a satisfactory adjustment of wages, equal in reduction to the amount suggested by the contractors, the crisis will have been justified because it will loosen a very large volume of building all over the city which has been held up pending a readjustment of building costs, both in materials and labors.

The announcement of a suspension of building activities has been sent out to the fifteen hundred members of two principal contractors' associations—the Associated Builders and the Building Construction Employers' Association.

ALMOST equalling in interest the dispute between the contractors and union builders, are the revelations which are coming forth as the result of the activities of the joint legislative building inquiry in progress in Chicago under the supervision of State Senator Dailey. A very unsavory state of affairs apparently has been uncovered by this legislative probe. Two general lines of investigation have been followed and each line was productive of results.

It has been very clearly shown, according to announcements of the members of the committee, that there has been a great deal of high-handed extortion on the part of union agents on building projects, and it has been almost as clearly revealed that there is an iron ring around Chicago that effectually precludes the use of mill-work made in other cities, whether by union or non-union shops. It has also been intimated that it is extremely difficult to buy lumber or other building supplies, unless the material is bought through Chicago representatives of the various lines who are members of local associations governing the various trades.

The exclusion of outside mill-work has been made the previous basis for Federal investigation here and large numbers of indictments are pending against local manufacturers, contractors and union agents, but the legislative probe is likely to result in a more general purification of the building atmosphere. State and Federal grand juries are to be impaneled for immediate action, and it is announced that sufficient evidence is already at hand to warrant, perhaps, thirty additional indictments.

THE Dailey Investigating Committee is not the only legislative force now affecting Chicago building. Tenant-favoring legislation has been making progress in the state legislature and many of the leasing provisions formerly in vogue here seem to have been swept by the board. This legislation, while heartily hailed by the tenantry of the city, is having a very dampening effect upon the ardor of those who formerly planned to erect apartment buildings as a matter of investment. It is estimated that the tenant measures—chief of which is the so-called Kessinger bill—will have the effect of modifying somewhat the extensive building program which was in contemplation before the legislation became so certain of enactment.

The record building permit of the season has just been granted to the Illinois Merchants' Bank for the erection of a skyscraper bank building at 223-241 South LaSalle Street, which is immediately opposite the Federal Reserve Bank Building, already under construction. It is estimated that the new bank, for which the permit has just been issued, will cost \$9,000,000. It is announced, however, that construction on this new building will not begin until next year, the builders having the hope that labor and supplies will be somewhat lower at that time.

The permit granted the bank is of interest, because it is the largest issued under a comparatively recent ruling which makes the fee 40c. per thousand feet of cubic space, as compared with the old rate of 10c. per thousand. The fee under the 40c. rate amounted to \$8,628.50. Graham, Anderson, Probst & White are the architects.

Building permits for April will break records, particularly in view of this large permit so recently issued. Mainly, however, the permits for the month

are for smaller structures, including at least a fair number of apartment permits.

ARCHITECTS were interested in the meeting here this week of the Millwork Cost Information Bureau, which has about 400 members, who are manufacturers of millwork in various parts of the country. The millwork manufacturers discussed the possibility and the expediency of adopting a uniform standard for all millwork, such as has been proposed by the standardization committee of the National Lumber Manufacturers' Association. Closer co-operation on the part of the architect in preparing detail of millwork to simplify quantity estimates by manufacturers was also bespoken by the manufacturers.

BUILDING CONDITIONS on the PACIFIC COAST

(Special Correspondence to THE AMERICAN ARCHITECT)

SEATTLE.—Adjustment between the various mill groups of sheet metals has steadied the market here, producing a well-defined increase in the movement. Stocks are heavy, however, and there may be little more buying on the new prices. Similar conditions prevail as to pipe, which has taken a reduction of about 5 per cent. in the basic price. This reduction has come too late to have any appreciable effect upon the season's building.

It is the general opinion here of jobbers in sheets and pipe that the market has now hit bottom. This will serve to quiet apprehensions in several commodities, as lumber is known to have reached the maximum at which it can be produced. Cement will show no recessions, according to statements of jobbers here, as the road-building program will consume all that can be produced during the coming six months without any recourse to the influence of the construction market. Sufficient legislation was put through during the past two years to represent several hundred miles of hard surfaced road, and three plants in Washington, and one at San Francisco, will be called upon to take care of these requirements. Road building on the coast has become almost a mania, and no one can foresee where it will stop. Long, hard-surfaced longitudinal tourist routes are planned, with laterals across each of the three states. Jobbers declare there can be little hope for recessions in cement prices, so long as this mania is on.

The nail market is stronger, although coast jobbers have not begun to quote on the replacement basis. Some of the mills in advancing from \$3 to \$3.25 base have projected a little strength into the market. There is already much complaint against the cost of nails, and it is seriously interfering with wood construction.

Construction activity in Alaska will be the heaviest this season since the beginning of the world war, according to contractors and builders, as a result of the Government railroad work and actual oil discoveries following a series of experimental drillings. In excess of 2,500 people have passed through this port on their way to the north within the past 60 days.

Interest in downtown real estate at Seattle was intensified this week through the leasing of a modern two-story building site on a retail basis of \$607,500. Wooden construction now in the property will be razed, and a modern two-story row at an expense of \$100,000 will take its place. It will have 20-foot stores and lofts 80 x 108 feet, suitable only for high-class mercantile purposes.

Charles H. Frye, the leading meat packer of the North Pacific coast, will erect a factory and warehouse costing \$250,000 at Connecticut and Charles streets, in what is known as the tide-flats or southern industrial section of the city. It will be two stories, of heavily constructed mill and reinforced concrete, 660 feet long and 163 feet deep with a frontage of 660 feet on Sixth avenue south. Loading and delivery platforms for handling meats will be built.

A new modern business block, to cost \$150,000, is to be built in the University district, the suburb that comprises the University of Washington. It will be three stories in height, with an ornamental front, including a theatre to seat 1,000, without steps of any kind. The structure will be 103 by 111 feet. Six stores are planned for the ground floor, 16 offices for the second floor, and seven apartments for the third floor. Automatic elevator service will be provided. A first mortgage bond, issued in the sum of \$55,000, covering the property and improvements, has been purchased by the Seattle Title Trust Company, and will be offered for subscription on a basis to net the investors 7 per cent.

The fir lumber market is steady for the week with some softening in special cuttings. Vertical grain flooring, finish and long dimension are nearly cleaned out. Eastern buyers have placed standing orders with some of the fir mills for long dimension. Average prices taken by the mills at the mill were \$52 for vertical grain flooring, \$16 for slash grain flooring, \$45 to \$53 for stepping, \$23 for ceiling, \$18.50 to \$23 for drop siding, \$12.50 to \$15 for boards and ship-lap and \$11.50 for dimension. While inquiries from the middle western and eastern territory served by the railways are light, there has been a brisk increase in water shipments to the Atlantic seaboard. Production at the mills is 36 per cent. below normal at 53,900,930 feet, and new business of 1,600 cars for rail delivery and loading of 1,454 cars.

572^a

For this piece to No. 2368



CHURCH OF S. STEPHEN, FLORENCE, ITALY

THE AMERICAN ARCHITECT

VOL. CXIX

WEDNESDAY, MAY 25, 1921

NUMBER 2368

FIFTY-FOURTH ANNUAL CONVENTION, AMERICAN INSTITUTE of ARCHITECTS, WASHINGTON, D. C., MAY 11, 12 and 13

VETERAN delegates to conventions of the American Institute of Architects are quite positive that there never was, and some express the hope that there never will be, a convention just like the present one. To those whose interest in conventions is centered on the social features, this convention, they declare, has not been a success. First, and to many decidedly the most depressing feature, was the "No smoking" rule, rigidly enforced. In no part of the National Museum building is smoking allowed. One may not slip out of the convention room for a quiet smoke. One must leave the building. The thin blue haze of smoke that floated over previous conventions, which while clouding the air seemed to clear the brains of delegates, was not present here. Then, the amphitheatre was too large, too roomy for the convention's size. There was a tendency to sit in detached groups. This did not promote intimacy. Further, the amphitheatre was naturally planned to give the best acoustic results when the speaker stood on the platform. Delegates speaking from their seats could not be clearly heard, and it was found necessary to ask those who spoke at length to speak from the platform. These things all had a tendency to retard the easy progress of the meeting.

A great many new faces were to be seen, and many were of the younger men of the profession. The older and better known men were not here in force. This had a tendency to promote detachment and a lack of that professional intercourse that forms so large and pleasant a part of convention hours apart from the sessions. One member made the good suggestion that there should be a social intercourse committee at conventions, whose duty it would be to frequent the hotel headquarters and see to it that men got acquainted with one another.

And the weather. A steady downpour for two days. Delegates who were visiting Washington for the first time and had planned some sightseeing trips were shut in by the rain which at times was torrential.

But the man who did not smoke, the man who came to Washington for the convention alone, and the men who are trying constructively to promote

the high ideals of the profession and were willing to submit to personal discomfort to accomplish them, did not adversely criticize everything. While it would not be true to claim that the present meeting was the most successful of any held, it is quite sure that it accomplished a very large measure of good result. It was purely a convention, as it should have been. The academic elements were missing, but in their places there was good hard-headed common sense, and a desire to turn the practice of architecture into those paths along which it has so successfully traveled in the past.

It was a dignified, hard working convention. It labored at all times for the best interests of the profession, and it cast aside impossible theoretical ideals, substituting the practical and constructive elements. And what more could be asked?

PRESIDENT KENDALL called the convention to order at ten o'clock. His address was received with much approval. It will be found in full on another page in this issue.

Reports of the various standing and special committees were presented. These will also be found, summarized in this issue.

A pleasing feature of the morning session and one that brought out the finest expressions of professional relations, was the presentation of charters to newly organized chapters. These were Arkansas, Florida, Kansas, Montana and Utah.

The interesting features of the afternoon session were an address by Harvey W. Corbett on Planning High Buildings for Narrow Streets, illustrated by a carefully prepared series of lantern slides, and a paper by Mr. John I. Bright on The Fundamentals of Town Planning. The open discussion following these features were valuable in the greatest degree. This meeting was very much worth while.

In the evening there was a Conference on Education, presided over by Mr. C. C. Zantlinger. The details of this important meeting are too many to find space in this brief account. No subject discussed during the convention was of larger importance than this on education. The committee has exhaustively considered the subject of education as

THE AMERICAN ARCHITECT

relating to the study of architecture, and it seems important that the research made should be carried to some actual accomplishment. It should not share the fate of previous well prepared reports. It is vital to the future of the profession of architecture that special effort be made along the lines of the excellent suggestions made in this document.

The president announced that the Fine-Arts medal of the Institute had been awarded to Paul Manship.

ROUTINE business absorbed the morning hours of the second day's meeting. A feature of the afternoon session was the "Parallel Sessions." While the convention remained in session until its scheduled time of closing, there was an adjournment at 3.15, to permit those who desired, to withdraw to attend the presentation in the lecture room near the auditorium of specially prepared papers. These papers, illustrated by lantern slides, were The Minor Architecture of France, by George S. Howe, and Recent American Collegiate Architecture by Charles Z. Klauder.

While a certain group of members was attending the lectures in the nearby lecture room, the work of the convention in the auditorium was proceeding in order. During this session, Mr. Robert D. Kohn presented the report on the Congress of the Building and Construction Industries, and Mr. Ernest J. Russell presented the report on the National Board for Jurisdictional Awards. Following this there was a spirited discussion on the economic problems of the building industry. A well prepared paper was presented by Charles H. Hammond of Chicago.

The evening session was crowded with many important events. In addition to the interesting ceremonies incident to the opening of the national exhibition of architecture, the Honorable Herbert Hoover, Secretary of Commerce, made a long and very full address, outlining the proposed policy on the part of the Government in the reconstruction of the building industry. A summary of Mr. Hoover's address will be found in this issue.

THE morning session of Friday, the last day of the convention, was, as is usual at Institute conventions, devoted to the conclusion of unfinished business, the report of the tellers of the election for officers, and a very spirited discussion on the report of the committee on state societies. The action of the convention in this matter is so important, and the results so far-reaching, that it is proposed to present in a later issue a very full summary.

The convention closed with an informal dinner at the Chevy Chase Club, and was a brilliant gathering of delegates to the convention, many of whom were accompanied by ladies.

National Architectural Exhibition

IN view of the "lean years" that have marked the practice of architecture during the past, it is remarkable that the Institute should have been able to gather so large and very dignified an exhibition as was hung on the walls in the National Museum. At all times throughout the convention, this fine showing of work by members of the Institute was thronged by studious observers. The committee in charge had worked most successfully, and the various chapters given splendid co-operation.

It was unfortunate that convention days were rainy days, for there can be no doubt that if the weather had been pleasant, there would have been a large attendance.

Probably there never has been shown in Washington a larger collection of architectural work and possibly there has never been opened to exhibition in any city a more dignified representation of our architectural development. The first exhibition, held in the Corcoran Galleries last year, while hastily assembled, was a good one, but the present showing, more leisurely undertaken, is far and away better. These exhibitions are very much to be encouraged. Their educational value is unlimited, and they afford a social center for delightful gatherings during the convention.

THE PRESIDENT'S ADDRESS

Fifty-Fourth Annual Convention of the American Institute of Architects

IN addressing you this morning I desire to allude, very briefly, to some of the ideals we hold and to some of the opportunities which it seems to me are open to us as architects in the immediate future.

The report of the board of directors will recite to you the work of the past year and reveal something of what is planned for the year to come. With all that there is of achievement in this record, I am sure you will be pleased. Where we have failed to accomplish, I beg you to be lenient and condone our shortcomings, for you will know that we have meant well.

I cannot, however, refrain from a few words of personal acknowledgment. It has meant much to me to have the cordial sympathy and support of the board of directors and its ready response to all calls for service has only been equaled by the response which has come from committees and chapters whenever a call came to them.

Individuals have undertaken strenuous tasks and carried them to completion. Committees have responded to the duties imposed upon them. Some, to whom we felt we had given the joy of leading forlorn hopes, have led on to victory and achievement beyond our hopes.

For all these things and for the steady and continued friendliness and confidence you have given me, I return you thanks and cherish a grateful memory.

I have been privileged to visit many of you in your home cities and to know your chapters, yourselves, and your work at first hand and face to face. To me it has been a great stimulus and inspiration and I believe every year the president may profitably carry out a plan of personal visitation.

I record with pride and appreciation that the topics we discussed and the things that interested you were the dignity and worth of our profession and the opportunities for public service which are offering themselves to us in this present time.

I saw architects spending their money and their time, using their abilities to the utmost, that the man with little money may have a well planned, thoroughly built home within his means.

I have seen competitive designs by hundreds sent in for nominal or no compensation, to the same ends.

Men of eminent ability have gone into public service in their cities and towns, have assumed professorships in our colleges that meant living upon a tithe of what their skill, exercised in architectural practice, would have earned for them.

Our boards have been officered by architects who gave not only their splendid abilities, but their time and paid their own expenses, amounting to many

hundred dollars, for what?—for their own gain or reputation? No, but in order that a great service to the working man, to the employees, or to the public might be done—and done well—and fair play and good faith between men and men might prevail.

In one Western city some of the architects are seeking hiding places and planning ruses, lest an appreciative public force them into the mayor's offices.

These conditions I find, in greater or less measure, from Atlantic to Pacific and it is, I believe, a sign of an appreciation which, although tardy and long delayed, is coming, and which we, as trained and efficient men, may receive, if we will but show ourselves worthy and willing to make the necessary sacrifices.

These things, however, are not to be attained simply by the practice of architecture. There must be joined thereto a sense of our responsibility to our communities and to the people among whom we live. To some of us it will mean the nation, to others our state, to many only our city or our town. According to our ability and our opportunity will the requirement be and the responsibility.

WE are facing a future for the profession, whose opportunities are almost unlimited. The country faces a need for buildings, unprecedented in amount. Housing and business make demands such as we have never known before and will not see again, unless, which God prevent, another World War shall again paralyze all beneficial enterprise.

Grateful communities all over the land desire to honor their dead and commemorate the service of those who dared all and returned. All that art can command, that skill can combine, that good design and inspiration can produce, is demanded for these symbols of gratitude. Who shall produce them if we do not?

I know of a combination of stone cutters, such as years ago would have been ready to furnish volunteers, carved at parade rest, full life size, in unlimited numbers, which in these days turns to the Institute and organizes a well conducted, properly paid competition (if any competition can be called well paid) in order to set up in their city a dignified and artistic monument to the soldiers of that place.

Commissions charged with erecting great memorials, costing millions, write to ask the Institute to advise them how to select suitably qualified men to design and supervise their buildings.

Who, today, plans to produce a home, a worthy business building, a public building of almost any grade, without the advice and assistance of an archi-

THE AMERICAN ARCHITECT

tect. We can hardly realize that a different state of affairs once prevailed, when, to quote one of the elders of our profession, Mr. George C. Mason, who has written most interestingly of the early days of the profession in this country, "the prospective employer applied to a builder for advice as to who was the best architect for him to employ," or ignoring the architect altogether, commissioned the builder to proceed without an architect.

When the fire (will Californians please note my accuracy) devastated San Francisco, the Governor of the State wired the Mayor of Philadelphia, "How many architects can Philadelphia furnish us and how soon can they leave for San Francisco?" From what I saw there, I question if such an appeal would now be thought necessary.

WE have heard much in late days of the encroachments of the engineer upon the fields of the architect, and we also hear much of the strangling effect of efficiency upon true art. I recently saw efficiency represented in a pageant as seated upon the shoulders of architecture with a stranglehold like an old man of the sea; the whole staggering upon limbs scarcely able to bear the load.

I am, personally, perhaps, more inclined to the practical than to the artistic; but I have all my life cherished an ardent admiration for the men who can see visions and dream dreams; whose finds conceive beauty and whose nerves tingle at discords; to whose feelings proportion and symmetry are essential. To them I pay all homage. Without their vision and courage, our art would be tame and commonplace indeed; but today we are learning that inspiration alone is not enough to insure a satisfactory result. The conception must have foundations; its airy pinnacles must be firmly fixed to the main mass; its vaulted halls and panelled walls must be conveniently and economically arranged. Our friends, the engineers, have given the bulk of their study to practical affairs, to convenience and utility, to accurate calculations of cost and construction. Sometimes, alas! we have ignored these items in our study of domes and spires. When we do we must expect the engineer to win against us: for the business man prefers a homely thing, which he can use, to a beautiful one, which cannot serve its purpose.

If we do our duty and avail ourselves of our opportunities, I do not fear the competition of the engineer, or of any other man; contractor or promoter, and I do not think you need do so.

You will perhaps say, "What has this to do with the ideals and brilliant possibilities you spoke of a few minutes ago?" This: (and I here wish to acknowledge my indebtedness to Mr. George C. Mason's record of early American architects as a professional body). The Association of American Architects had its beginnings in a gathering of a few architects, under the title of the "American Institute of Architects," which held its first convention

in Philadelphia, in 1837, the year in which, it may be remembered, the Institute of British Architects was founded.

The Institution numbered some twenty-five practicing architects only. It was difficult for so few men, scattered all over the country, to maintain an efficient organization and the Institution was dormant for nearly twenty years, coming to life in 1857.

It reorganized as the American Institute of Architects and was chartered in New York. Many of the founders became eminent in the history of the profession. From that day to this, the objects of the Institute have been as stated in the charter.

"To organize and unite in fellowship the architects of the United States of America and to combine their efforts so as to promote the artistic, scientific, and practical efficiency of the profession."

Our friend Efficiency was alive even then you see.

Has it done so? I maintain that it has. The ethical standards of the profession, I almost said "moral," have been steadily held before us, almost too steadily we have sometimes thought, until today, whether we practice them or not, and I believe we almost always do, we know the right thing and generally we do it and I am certain that if we do occasionally err, the feeling of shame takes the satisfaction out of any profit we may gain.

The Institute has steadily held that the good of the whole was far greater than the gain of any one individual and has consistently urged that we relate our actions to that high principle.

Its interest in the men of the future has never wavered. Its earliest officers were men of vision and they opened their offices for the training of students, when there was no other door open to the would-be architect than that through this experience in the office of a qualified chief.

In such an office was trained Wm. R. Ware, the founder of the first Architectural School in America at Technology, in Boston, and later that at Columbia. Since his day many of his students have been teachers and organizers in other schools of architecture. These men and their successors have been active and honored members of the Institute and we today join hands with them in their work of training the architects of the future. We discuss with them their courses of study, and they even allow us, occasionally, to speak to their students. Our co-operation is hearty and appreciative.

Our interest is vital and efficient in our chapters and in our individual membership. Our men of high scholastic training have organized ateliers, taught classes, given free service, advice, and criticism, to students and draftsmen, and aided in developing a trained, artistic and efficient body of draftsmen, embryo architects, many of whom are today practicing their profession with honor and success.

In this connection I again avail myself of Mr. Mason's research and quote from Horman. Who he is I know not, but from his spelling he must be a

THE AMERICAN ARCHITECT

contemporary of Chaucer. "He is not worthy to be called mayster of his craft that is not cunynge in drawings and picturyng."

WE have, by showing our good work, by upholding high standards of design, by the examples presented to the public of worthy art, and by timely criticism of poor work, raised the public appreciation of good things and quickened the ability to detect and reject the bad.

We claim a large part in this; not all is due to the Institute. All honor to the worthy men who by themselves or in other groups have striven for high ideals, have worked to elevate public taste, and correct immoral conditions. We envy them, we desire their fellowship and their help in our own problems and to help them in theirs. We therefore again, as in the past, extend to them an invitation to membership in the Institute and to the fellowship which such membership will bring.

We believe that in the future such association will strengthen every man's hand for his task and that many who practically live up to the standards of the Institute, would help our work and strengthen their own standing, if they joined our ranks.

Believing this, an active campaign has been carried on this year, under the direction of a National Chairman, Mr. A. P. Clark, assisted by our efficient Octagon staff, and handled as to its local work by splendid committees from the chapters, to increase our membership and extend our influence. Nearly seven hundred names have been added, an addition of more than 33 per cent. to our membership.

We welcome these new members, we are proud and gratified to have them with us, and we hope for a still further increase in the future. With from ten to fifteen thousand persons claiming to be architects

in the country, we must have a larger membership if we are to be a truly representative body.

It is fitting that I acknowledge here the splendid service of our membership committees in the several chapters and the efficient prosecution of the work by the Executive Secretary.

But what of these new men? Their good impressions of us wane and fade if we rest content with having placed their names on our roll of membership. So strong a body of men should command recognition and I hope that chapters will be at pains to recognize their ability and qualifications, to give them place and privilege as opportunity may offer, and to imbue them thoroughly with loyalty and affection for the chapter and the Institute.

We shall hope early to become acquainted and to recognize in our national committees the added strength which has come to the Institute. A degree of rotation in our committee appointees seems desirable, in order to use new men, and will be considered in new appointments.

May I here lay emphasis upon the vital fact that the chapters are the Institute; that *there* is exhibited the Institute spirit, that *there* most of us become acquainted with the ideals and realities of what a member of the Institute is and that as we act and are, so will the conception, true, or false, be formed.

Let us not hear again the query, "Why can a member older than I, more prominent in the Institute, do with impunity, things which mean discipline if done by me?" It ought not to be possible for such a statement to be made.

Gentlemen, I started to set before you high ideals. I begin to realize how futile is such an endeavor. You already have them. You are doubtless living up to them more perfectly than I. I can only say, inadequately and imperfectly, I believe in them, I try to practice them, I pray you go and do likewise.



THE COMMITTEE REPORTS

A Summary of the Reports of Certain Committees, As Presented to the Fifty-Fourth Annual Convention of the American Institute of Architects

Fire Prevention

The Committee on Fire Prevention urges upon architects to interest themselves generally in the securing of needed amendments to existing building codes. Further, the report states:

We believe that now is the proper time to revise building codes generally, and remove from them all unnecessary restrictive requirements. For example, the building codes of most large cities at present do not permit of the use of the newly developed hollow brick wall, the scientific use of hollow tile, the proper use of the concrete building block and other types of construction which have been recently developed and which, if permitted, will result in quite materially reducing the cost of construction of the so urgently needed housing.

Your Committee wishes to announce that the report of "Fire Tests of Building Columns" made by The Associated Factory Mutual Fire Insurance Companies, The National Board of Fire Underwriters and the Bureau of Standards, Department of Commerce, jointly conducted at the Underwriters' Laboratories, Chicago, has now been published and issued. Every architect should secure a copy of this report. The report is conclusive as to the fire-resisting qualities of the different types of fireproofing, etc.

Building

The Committee reported that the Octagon, the headquarters of the Institute in Washington, is in good condition structurally, but that there are various things which could with advantage be done if funds were provided.

Public Works

Due to lack of interest in Congress to bring about the reorganization of the Executive Department of the Government, this Committee reports its activities have been limited during the past year.

The report states:

As individual citizens, and as an organization realizing the present inefficient operation of the Executive Departments, we should now, more than ever, employ every influence to bring about their reorganization, exerting our greatest effort on the Department of Public Works, because of our intimate knowledge of its requirements.

To this end your Committee offers the following Resolution:

Resolved, that the American Institute of Architects, in convention assembled, realizes the imperative need of early reorganization of the Executive Departments of our Government, and endorses any reorganization looking to more economic and efficient administration.

That this organization is particularly impressed with the creation of a Department of Public Works, and offers its best efforts to any Committee of Congress whose duty it may be to recommend the proper functioning of such a department.

Foreign Building Co-operation

The report states in part, as follows:

The work of the Committee on Foreign Building Co-operation during the past year has been confined to the

gathering together and shipping to France for exhibition of a collection of drawings and photographs of American Architecture.

The exhibition held last year in the Corcoran Art Gallery roused the enthusiasm of two visiting French architects, with the result that an offer was made by the President of the Société des Artistes Français, colloquially known as the "Old Salon" to set aside a section in this year's exhibition, if the Institute would gather together the material. The invitation was accepted by the Board of Directors and the work of arranging for the exhibition and selecting the drawings and photographs was turned over to this Committee.

The Committee serving as a jury, held four formal sessions to examine the work submitted and the drawings selected came from a total of 477 submitted. As there were no Institute funds available for the expenses of the exhibition, it became necessary to assess the exhibitors on the amount of space covered by their exhibits.

The Committee was fortunate, in that its Secretary, Mr. Julian C. Levi, has found it possible to accompany the drawings to France and to supervise the hangings of the Exhibit and the preparation of the catalog.

The Salon Exhibition closes about July 1st, and it is hoped to get the exhibits back within two or three months at most.

It has been suggested that this work be exhibited on its return to America in the Fall.

War Memorials

The Committee on War Memorials submits the following report:

Acting within the scope of the instructions of the Board of Directors, as well as within the resources at the command of your Committee, it has throughout the past year rendered such advisory service to promoters of memorial projects as occasion offered. In the majority of instances the inquiries that have come to your Committee have included requests for designs or illustrations suggesting typical solutions of memorial problems and in response your Committee has forwarded the literature issued by other organizations as directed by the Board of Directors in the absence of similar publications on the part of the Institute.

The conditions which have held in abeyance many building operations have in like manner prevented the development and realization of memorial projects besides which your Committee has had occasion to note an abatement of popular interest on the subject. This apparent recession of the wave of enthusiasm that followed the armistice and the unfavorable building conditions have had the advantage at least of diminishing the number of hastily considered memorial structures and at the same time have extended the opportunity for more careful study of the many memorials that are still under serious consideration.

Small Houses

The report of this Committee covers sixteen pages of type matter and illustration. It treats in the most thorough manner the subject of the designing and planning of the low cost house, and offers for approval by the Institute a proposed Certificate of Incorporation for Architects' Small House Service Bureaus. The working of the Minnesota Bureau is set forth in detail. This report is a valuable document and its discussion during the convention one of the most important features. Architects

THE AMERICAN ARCHITECT

everywhere in this country should interest themselves in this important movement, and familiarize themselves with this valuable report.

Registration Laws

The report of this Committee takes up and discusses the matter of registration laws in the United States. It states:

We would particularly urge that all states scan their laws with care and that when conditions are favorable, amendments be secured which will eliminate undesirable features, particularly those highly detailed provisions which create difficulties as between one state and others. Indeed reasonable agreement is desirable between all the states having registration laws if architects are to conduct interstate practice.

Your Committee is of the opinion that the form of recommended uniform law for registration of Architects, Engineers and Land Surveyors as revised by the Joint Committee of representatives of the American Institute of Architects and Engineering Council is a valuable document and an earnest and painstaking effort at co-operation of the professions, but that the Institute should reaffirm its opposition to the passage of such joint laws.

The Committee is thoroughly convinced that Engineers and Architects should co-operate to the utmost with respect to legislation, but that the legislation for the two professions should be distinct.

State Societies

This report discusses at some length the result of a survey on the part of the Committee on the Status of State Societies. The report concludes:

Suggestions have been many and varied and have ranged from "paternalism" on the part of the Institute toward State Societies, to full recognition of State Societies as affiliated members of the Institute, with a delegate voting power on the floor of the Convention, in a much smaller ratio to their membership than that accorded to Chapters. The carrying out of this latter suggestion would require that the Constitution and By-Laws of the Institute be amended and would create an anomalous situation that would be pregnant of con-

fusion and misunderstanding, and in the last analysis be seriously detrimental to the independent growth and action of both organizations. The relationship of the State Society toward the Institute would, it seems to your Committee, be less dignified were they to be given only partial representation, than it would be were they recognized as independent organizations and offered full opportunity for co-operation on an even footing.

Because of the varying conditions surrounding the practice of architecture in different parts of the country and the lack of uniformity in the organization and administration of various State Societies, it seems inexpedient at this time to commit the Institute to any countrywide policy, but rather to set a point of contact between the Institute and the State Societies that will be flexible and possible of easy expansion.

Your committee, therefore, makes the following recommendations:

(a) That as a general policy State Societies shall be invited to send delegates to the Convention of the Institute. These delegates to have the right of the floor on all subjects except those affecting Institute policy, but not to have the right to vote.

(b) That the Institute shall create a Standing Conference Board on State Societies, charged with the following duties:

1. To keep informed as to the officers and membership of State Societies.

2. To request parliamentary action by State Societies on questions of importance (not of Institute policy) submitted to the Chapters, and to receive and file with the Secretary the result of such action.

3. To meet with delegates from State Societies either at the convention or at specially arranged conferences at which delegates shall have full parliamentary privilege, and to report to the Convention for action any resolutions, recommendations, or motions adopted at such meetings.

4. To receive communications from State Societies where they may wish to secure co-operative action by the Institute, and to present recommendations to the Board or Executive Committee of the Institute for action, or reference to Chapters.

5. To solicit the support of State Societies where they can be helpful to the Institute.

6. To assist newly formed societies in the preparation of their Constitution and By-Laws.

7. To assist Societies in their efforts to secure the passage of Registration Laws.

This Country's Oldest House

THE oldest house in the United States is now standing at St. Augustine, Fla. Not only is this venerable piece of architecture of sufficient age to attract lovers of antiquity and students of history, but it is of sufficient mysticism to allure the less serious minded for it romantically offers the visitor of today the use of its wishing well and its magic bell.

An interesting account in the *New York Post* was prepared by Frances Arnold and ran in part as follows:

When Pedro Menendez came to the New World in 1566 to found a settlement in the Ponce de Leon famed Land of Flowers, he brought with him from Spain more than two thousand people, among whom were twenty-seven monks.

This house was built for the monks and was their worshipping place and living quarters for twenty-five years. Their sleeping spaces were cells in the rooms on the second floor, the ceilings of which—and the visitor is told they are the original—are inlaid with little blocks of wood, so cut and arranged

as to form a coffin-shaped design. It is said the good monks slept nightly in coffins, so as to keep thoughts of death always before them. Death alone, they reasoned, is free from sin.

Victoriously it has withstood 350 years of exposure to the weather, seven English attacks, conducted by the best known methods of their time, and five Indian massacres. Moreover, to its credit, it is recorded that when that bold explorer Sir Francis Drake attacked the city of St. Augustine in 1572 this little old house, then quite new, was the only building not destroyed. It was the only one built of coquina.

About two years ago the oldest house was purchased by the Historical Society of St. Augustine and every room is now filled with a collection of curiosities and historical antiques, gathered not only from America and the familiar haunts of travel-worn Europe, but also from out of the way secluded corners of Asia and Africa.

It stands today a silent witness to a country's history and a fascinating connecting link between the present and the past.

NATIONAL COUNCIL of ARCHITECTURAL REGISTRATION BOARDS

THE National Council of Architectural Registration Boards met on the evening of May 10 and the morning of May 14 in the National Museum at Washington. The Council was formally organized at a special meeting held in St. Louis last November, since which time the details of organization and operation have been worked out and given effect. Detailed reports were read on the work of the Council showing that it is functioning as a clearing house for registration boards; on the part of architects desiring to do interstate practice that it is collecting information greatly facilitating the work of the various registration boards with respect to reciprocity. In order to make possible reciprocity, it is also studying the standards of examination, with a view to leaving the various boards considerable freedom in their interpretation. Messrs. Sylvain Schnaittacher of the California Board and Arthur Peabody of the Wisconsin Board read papers on examinations. Mr. Richard E. Schmidt, Chairman of the Committee on Registration Laws of the Institute, discussed registration laws which are either under consideration or which have been recently given effect.

The organization reaffirmed the vote taken by it at the St. Louis meeting against joint laws for archi-

tecs and engineers, while recommending the fullest possible co-operation between engineers and architects in the securing of mutually acceptable laws.

In addition to registration boards, a number of Institute chapters and state architectural associations have joined the Council as associate members. More such members are needed to enable the Council to do its work effectively and to cover its cost of operation, its services being rendered at cost. The office of the Council is at 3230 West Monroe Street, Chicago, Ill. Full information will gladly be furnished by Emery Stanford Hall, secretary-treasurer, who has given an extraordinary amount of energy to the work of the Council.

One meeting of the Executive Board was held in Chicago in March. The convention gave hearty approval to the work of its officers. The executive board was extended by the addition of two vice-presidents—Messrs. Sylvain Schnaittacher, of the California registration board, and W. H. Lord, of the North Carolina board.

The following officers were re-elected: President, Emil Lorch, Ann Arbor, Mich.; vice-president, Arthur Peabody, Madison, Wis.; secretary-treasurer, Emery Stanford Hall, Chicago, Ill.

NOTES of the CONVENTION

The ballot for the election of officers and directors for the coming year resulted as follows:

For president, Henry H. Kendall; first vice-president, William B. Faville; second vice-president, Robert D. Kohn; secretary, William Stanley Parker; treasurer, D. Everett Waid. The directors were L. P. Wheat, Jr., of Washington, D. C., Chas. A. Favrot of New Orleans, and George E. Bergstrom of Los Angeles, Cal.

The report of the committee on credentials stated that there were 223 regularly accredited delegates, 14 ex-officio, 13 proxies, 31 non-delegate Institute members and 2 ex-presidents, Messrs. Irving K. Pond and Thomas C. Kimball, a total of 283 members present.

The present membership of the Institute as set forth in a report of the Board of Directors, as on May 9, 1921, was 2,256, being a gain since the last report of 726 members, or a net gain in active membership of 683.

A feature that was availed of by the visiting delegates and guests of the convention was the magnificent exhibition of American art, hung on the walls of the National Museum galleries on the floor above the auditorium. This splendid collection of paintings, the gift of numerous generous donors, forms the nucleus of what will undoubtedly some day be the finest collection to be found in this country, and one that will give a very great stimulus to the advancement of the painter's art in America.

Many members were quick to approve the suggestion that there should be a special committee of the Institute appointed in order to promote a more intimate association between visiting delegates during convention days.

The details of the business conduct of the convention, the reception of guests and the attention to the needs of the visiting members were admirably worked out by Mr. Kemper, executive secretary, who is to be highly commended for many successful features of the convention.

URBAN CONGESTION—A STUDY of ITS CAUSES and SUGGESTIONS For ITS ERADICATION

By JOHN IRWIN BRIGHT

An Address Delivered Before the Fifty-fourth Annual Convention of the A. I. A.

THE following remarks deal with those special problems of congestion characteristic of a metropolitan center. Large cities differ fundamentally from small cities. The relations of New York to London or to San Francisco are somewhat different from the relations of small cities to each other. In the larger agglomeration there must be located what is loosely termed "big business"; there must be great banks, large commercial units serving the needs of international trade and concentration. It is a phenomenon that creates special problems of its own.

Preliminary to any study of urban congestion it is important to search for and define the clauses separating and qualifying them in order of their importance. While concentration of wealth is without doubt a major cause under our *laissez faire* yet congestion could be eliminated by some physical change in the plan without affecting present control of credit. Large scale industry requires that its facilities be concentrated; its factories, offices and banks must occupy a relatively restricted area, but it is entirely conceivable that the present economic system could exist under conditions where there would be no crowding. Although superficially modern business enterprise seems to create congestion it is to my mind a contributory but not a major cause.

The control of land value is of a deeper significance. Private control of site value insists upon a constant increase in price, obtainable only by increased intensity of use. Its uniform demand is more crowding. It is the one great economic cause of congestion.

It is the capitalization of location or site value that determines the price of land and the interest on this capitalization is rent. Rent rises and falls according to the demand. The land owner never furnishes in any minute degree any service for rent received. He has created no wealth, he has performed no work. He lives entirely by the labor of others. As population increases the use value of land rises and is capitalized by the land owner. The rent is raised. The money so paid out is a drag upon production and production can never hope to recoup itself for in the measure as it prospers the land owner is ready to absorb practically all of the increment. The money earned by productive effort becomes the unearned increment of the land owner.

That which is spent upon the land is in a different category. The cost of buildings is practically the

same in any locality and the tenant pays to its owner a sum representing interest on capital invested and maintenance, repairs, depreciation and obsolescence. It is essentially the sale and purchase of a manufactured product. In the language of an economist it is a return on an investment as differentiated from rent.

Rent, properly speaking, is always based on the capacity to pay and aims at the absorption of the difference between the cost of production and the selling price. Ever increasing concentration is forced by it, and as long as private speculation in land exists our cities will be more and more hampered for sufficient space.

I am absolutely convinced that as architects and city planners we are powerless to carry out our ideals until the speculative control of land values, the main incentive to congestion, is rendered harmless to the community.

Together with this reform municipalities must have the power to determine the intensity of use of a given unit of ground. It is one of the principles of zoning. It is a provision solely for traffic convenience in order that street and rail facilities may be proportioned to the load they are to bear. It is quite hopeless to expect a street designed for a certain intensity of traffic to serve efficiently any future increases no matter how large they may be. A limit must be set upon the number of usable square feet of floor on any given area. The number of human beings using a given ground area must be kept within bounds if cities are to be made workable.

It is now in order to consider the street design and to inquire into the causes of congestion from an engineering point of view.

The diagram of a typical city shows one or more highly congested areas and a street system as a means for their maintenance and growth. When conditions become uncomfortable the almost universal practice is to construct by-passes as a means by which traffic may be diverted. This and the widening of streets are the generally accepted methods of dealing with the evil. But experience teaches with disconcerting uniformity that while for a time the conditions are bettered by these measures, yet no lasting improvement is effected. The technique is predicated upon the assumption that enough of the traffic flow will use the by-pass to relieve the central jam. But as the business necessary for the crowded area accounts for more

THE AMERICAN ARCHITECT

than enough traffic to create the condition it is desired to eliminate, the pressure remains unrelieved. From ten to fifteen per cent. of the entire number of vehicles might seek the perimeter and the remainder would not be affected. It is important to insist that traffic conditions in general are not benefited by a system of by-passes.

Street widening is largely ineffective because traffic is congested only to a minor degree by the inadequate width of the roadbed. The principal cause is the interruption of traffic streams at street intersections. It is a point which can be illustrated by a four-way plumbing connection to which are attached pipes of equal diameters. It would be quite useless to attempt to pump water through the system if pressure were applied at each of the four pipes simultaneously. To obtain any circulation two pipes must be cut off by valves, a check valve of the desired direction placed in the third pipe and then pressure applied at the end of the fourth pipe will force water freely through the central four-way connection. This illustrates traffic control at street intersections. The valves represent policemen and the water represents flow of traffic. It is evident that the situation would not be improved if one or more two-inch pipes be substituted for those of smaller dimensions. It would allow more water, or in the case of the streets, more vehicles to accumulate at the point of opposition, but the time lost by each vehicle by the arresting of movement would be substantially the same.

The design of street intersection in such a way as to avoid traffic interruption is the one way to cure congestion.

In order fully to illustrate the point, I have redesigned the central two square miles of Philadelphia, conceiving it as a purely commercial center in the metropolitan sense of the word. On such a basis there must be excluded all buildings devoted to residential or amusement purposes. These classes of structures, such as hotels, apartment houses and theatres, should be grouped around the main inter-city passenger transportation unit or units. There would be left only those buildings devoted in the main to large mercantile establishments, wholesale and retail, banks, offices and the larger public buildings. Having determined the character of occupation there is assumed as a necessary factor for the street design the maximum extent of usable floor space in each block to be served by the transportation facilities. As the floor space must be evenly distributed over the district, an arbitrary height of five stories has been adopted. It is an arrangement that in no way precludes a variety of facade nor does it even prevent the erection of very high towers provided that the volume of the building does not exceed a certain limit. Height has no bearing upon the problem of transportation, to which for the moment the field of inquiry is restricted.

The comparison between the old and the new plans is extremely interesting. The area studied is 1,228 acres, of which 28 acres are devoted to parks and 1,200 acres to buildings of all kinds and the street system. The street system is 385 acres, or almost one-third of the entire area. The usable floor space of all kinds is in excess of 975 acres. The new system would show that 795 acres are covered by buildings and streets, of which about 21.3 per cent. is devoted to streets, while the park area is increased to 434 acres, compared to 28 acres as at present. The total new floor space, planned with due regard to comfort and efficiency, is about 1,500 acres, more than one and one-half times the present figure. The park system has nothing to do with the transportation problem, and it is very possibly in excess of a reasonable requirement, but as represented on this plan it becomes the by-product of a well considered arrangement.

Having determined the volume of the buildings and the space they are to occupy the street system can next be studied.

The plan represents in principle an office building covering an entire square and having in the center an open court. There would be but one main traffic loop serving directly the buildings on its either side, again comparable to the corridor of an office building. The loop would serve the three main divisions of traffic, pedestrian, vehicular and rail, separated on super-imposed levels. Pedestrians using the upper tier would be able to walk from one part of the district to another without at any time being forced to descend to the vehicular level. Vehicular traffic would be on the next level and the street intersections would be so designed that at no time and at no place would traffic streams cross at right angles. The typical intersection would be designed on the familiar plan of a turning monument, while the more important intersections could have two vehicular levels in order to expedite movement. This latter detail obviates the necessity of constructing an enormously expensive by-pass to be used by but 10 per cent. of the entire volume of traffic.

Rail transportation would enter the district by the loop and would be accommodated in open cuts, not subway. Suburban trains would stop at the main passenger distribution center outside of the district only for the purpose of making connections with trains of the inter-city system.

The commuting passengers without descending at the main station would then be transported directly to their destination in any part of the district. The concentration caused by main passenger stations surrounded of necessity under the present system by hotels, department stores and so forth would be entirely obviated under this plan. The rapid transit system would occupy the same open cuts and the local service cars entering the district would also follow the same route. In Philadelphia 90 per cent.

of the entire business of the street railway company is conducted in the central area, and most of the fares are collected during one hour in the morning and three-quarters of an hour in the afternoon. The present street system affords no means by which these huge numbers of people can be properly accommodated. The design here advocated would permit of an elasticity of operation hitherto undreamed of. The traffic loop could be worked quite independently of the rest of the street railway system, while at any time and at any point it could be instantly united to the general system.

The principle of the transportation system as here laid down both for rail and vehicular traffic is the avoidance of the interruption of traffic systems. It is the next great step in the planning of our metropolitan areas. No mention is here made of the economics to be affected by the proper planning of buildings and streets, nor is there any attempt to

compute the cost of the installation of such a system. The thought uppermost in my mind is to present the idea in diagrammatic form applicable in its broad lines to any city, and therefore any definite estimates of cost would be beside the point. It is impossible, however, to examine this scheme without realizing its bearing upon the conservation of human energy and life. Its capital cost would no doubt be great, but its enormously lessened cost of operation is a still more important factor to be considered.

As I see it, the main question is not one of finance, formidable as that may be. We are approaching a situation where a radical change in street planning is imperative. When the necessity is realized by a sufficient number of people the enterprise will be embarked upon and methods of financing it will be discovered. Our cities must solve the problems which they themselves created or our civilization cannot maintain itself.

A LEGACY TO POSTERITY

The manager of the Bush Company's proposed building at Kingsway would revive a quaint old custom, states *The Architects' and Builders' Journal* of London. He would bury in the foundations of his buildings a collection of objects that are characteristic of the time in which those foundations are made. He had been struck, it seems, by the difficulty Mr. Wells had encountered in writing ancient history—so few material survivals of three thousand years ago have come down to us. Now, the foundations of the Bush building, being constructed of reinforced concrete, will (unless they are deliberately destroyed) last three thousand years or more. Sympathizing with Mr. Wells's deprivation, and wishful of providing the historian of three thousand years hence with greater abundance of contemporary detail, the Bush manager thinks of embedding in the concrete foundations a casket containing objects typical of our times. What should they be? Happy thought—why not secure the cooperation (and incidentally the autograph, to say nothing of the potentialities of advertisement implied in a name of such renown) of Mr. H. G. Wells? The catalogue of common objects that Mr. Wells suggested in his very obliging reply is too long to quote here. It includes "samples of patent medicines and what they profess to cure," a "current book on 'How to Behave,' and town maps and plans." These things and the others to be inurned with them should be carefully described and explained, lest the vastly more civilized persons of three thousand years ahead should be perplexed as to whether, for instance, the book on "How to Be-

have" should be taken quite seriously; for surely such a book will reveal the primitive barbarians of 1921 as incredibly ridiculous creatures; while the "town maps and plans" will confirm the impression of twentieth-century ineptitude. All this, however, is based on the sanguine but utterly unsound assumption that these ghastly relics will not be disclosed until the lapse of three thousand years. Modern buildings have no such length of days, and the Bush building will have disappeared, foundations and all, leaving not a wreck behind, about two thousand nine hundred or more years before the time scheduled for the revelation of the relics. It will have disappeared not because of any sort of instability, but because love of change, fickleness of fashion and fancy, will ordain that some different building shall take its place. So the ingenuity of the manager and the genial compliance of Mr. H. G. Wells are entirely wasted? Not at all. Remote posterity may have no reason to bless them; but, in their own day and generation, what a splendid advertisement they get out of the manager's brilliant idea. Not that this was at all the intention: it has simply cropped up incidentally, and spontaneously, as so many happy unpremeditated effects are apt to do. Foundations—or, rather, foundation-stones—seem inseparable from advertisement. The mayor, the alderman, and the pious founder, often find in the inscription the sole means of going down to posterity. Even the architect has been known to have his name thus immortalized by accompanying the names of the civic magnates, usually cut in rather smaller letters on an obscure corner of the stone.

*Doorway to Fairfax House,
Alexandria, Va.*

(See reproduction of original drawing by O. R. Eggers on opposite page)

*A*T the opening of the Revolutionary War, the "Virginia Fairfaxes" were the best known of the American Colonial pioneers of English birth. Thomas, sixth Baron Fairfax, had acquired an immense estate in Virginia, which comprised about one-quarter of the entire colony. Though ardent loyalist during the Revolution, the Fairfaxes were permitted to dwell in peace in their manor house near Winchester.

The sketch presented by Mr. Eggers in this issue shows the Fairfax house in Alexandria, Va. It is typical of the best work of this period, and undoubtedly was the product of one of those now unknown carpenter-architects who so efficiently built along our Eastern seaboard during the close of the eighteenth century. This house stands today but little changed from its original design, and the porch selected by Mr. Eggers as the subject of the present sketch is one of the many that have given inspiration to architects as among the best details of our Colonial period. These carpenter-architects unquestionably worked, as did our great modern painters, to achieve simplicity with fullness. It is the outstanding characteristic of all of our best early Colonial work, and the result is a purity of classic beauty that is unsurpassed.



DOORWAY TO FAIRFAX HOUSE, ALEXANDRIA, VA.
THE AMERICAN ARCHITECT Series of Early American Architecture



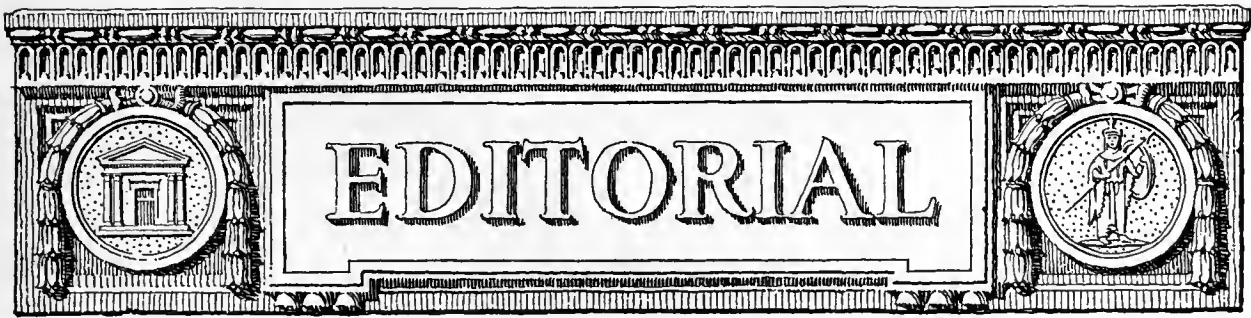

Editorial Announcement

THE publishers of THE AMERICAN ARCHITECT take pleasure in announcing that Ernest McCullough, C. E., Ph. D., is now associate editor.

Colonel McCullough is widely known in the professions of architecture and engineering through his many books and contributed articles to leading technical publications. He assumes his present connection after long and efficient service in the U. S. Army. He is now returned to civil life, retiring from the army with rank of Lt. Colonel, Chemical Warfare Service, U. S. R. C. It is believed that Colonel McCullough's wide experience and highly trained ability as an architect and engineer will create for THE AMERICAN ARCHITECT, and particularly its Department of Architectural Engineering, features that will be found of great importance.

For What Is a Public Library Maintained?

FOR what purpose is a public library built and maintained? In view of the many attitudes of officialdom in New York City towards our Public Library, it is reasonable to ask this question. The taxpayers of New York have acquired by purchase and generous donation many volumes, and erected a costly and dignified building, where this vast treasure might be safely housed and where it might be, with reasonable restriction, readily accessible.

The official ideas of the purpose to be served by a library are apparently much at variance with established custom. Studious people use a library for purposes of study and research. Quietness and order are essentials of a library's working spaces. Perhaps it was a mistake at the outset to place our Public Library on the principal thoroughfare and also on its very corner of most congested traffic. But, having made the error, if it was one, it does not seem necessary to have turned the approach of the Library into a reviewing stand or to have located all the many "drives" on its steps.

For days before some contemplated review the Library front is marred by unsightly structures of rough boarding, a lurking place for litter and rubbish. During the hours of parades, the Library is the point where the blare of bands and the shouts of an applauding public, make it impossible for

frequenters of the Library to pursue their studies in that quiet which is undoubtedly necessary. While these things are, of course, no disrespect to the cause of learning, they show a lack of knowledge of essential characteristics of a library's environment.

SILENT, but equally disrespectful features of Library surroundings are the blatant signs which disfigure the corner of Forty-second Street and Fifth Avenue. Decency and public pride demand the removal of these nuisances, erected for private greed in direct violation of the public rights. Bad enough by day light, they are worse at night. The alternating and flickering lights cast dark shadows or bright flares into the rooms of the Library to the positive discomfort of those who use them. Is it possible that there is no legal redress for this sort of thing? The City has spent many millions in creating a beautiful civic center. Does the City have to submit while sordid individuals use this fine building as a background for the exploitation of their wares? It is bad enough to have this pest of sign boards on Riverside Drive, or along the pleasure roads bordering our rivers, but it is more than a disgrace to permit them in such close proximity to our Public Library.

A National Duty

THERE was universal surprise, and in many cases actual resentment shown, when the delegates to a Masonic convention held in Washington, visited Mount Vernon, and were each compelled to pay an admission fee of 25 cents.

Mount Vernon, the most sacred shrine of patriotism in this country, is not under the control of the Government, but is in private hands. A number of years ago, a number of patriotic women, alarmed at the possibility of Mount Vernon crumbling to decay, owing to its then neglected condition, acquired the property and zealously set about its restoration.

This result they have splendidly accomplished. The small fee of 25 cents, charged for admission, barely pays the expenses of upkeep.

Undoubtedly Mount Vernon should become the property of the nation. But, it should also be left in control of the woman's organization which now so efficiently guards it.

A LOUIS XV PANELED ROOM

THE Metropolitan Museum of Art, New York, through the further generosity of J. Pierpont Morgan, has recently acquired the woodwork of a room of the period of Louis XV. The paneling has been installed on the second floor of the Morgan Wing. In its original position the woodwork probably made the four walls of a room, but the exigencies of installation have necessitated a three-sided arrangement of the four walls of a room, but the exigencies of which is on exhibition close by. It is impossible to say just what the original arrangement was, but the presence of an alcove, about ten feet in width, would suggest that it was a bedroom. At the period, even among the lesser society, the latter was used largely for reception purposes, which would explain a treatment somewhat over-elaborate according to modern ideas, as may be seen by glancing at any of the numerous engravings of domestic interiors published during the eighteenth century.

The woodwork comes from a house in the Rue Thorigny, Paris, which is said once to have been in the possession of Madame de Pompadour. Thus

it comes from the quarter of the Marais, occupied in general during the period by the lesser nobility and the richer bourgeoisie, or upper middle class, and it was probably for a family of the latter class that the room was made, somewhere between the years 1740 and 1750. We cannot, of course, judge such a room by the ultimate standard of the princely work at Versailles carried out by Verberckt and the brothers Rousseau, or even by the gorgeous decoration of the Hôtels de Rohan and Soubise in the same quarter. Too often, however, we are blinded by the superlative qualities of creations of this type, which are of course few in number, and fail to see and appreciate the quality of the work done to supply the needs of a slenderer purse and humbler taste. The new room is a good example of this latter type and shows to what a degree of excellence the better class of popular work had attained at this date, following in its own way the tradition and developing standard of the court.

The architects of the day furnished for the smaller

(Continued on page 595)



WOODWORK FROM A ROOM OF THE LOUIS XV PERIOD, FORMERLY IN A HOUSE IN THE RUE THORIGNY, PARIS, SAID ONCE TO HAVE BEEN IN THE POSSESSION OF MADAME DE POMPADOUR

Gift of J. Pierpont Morgan to Metropolitan Museum of Art



HOUSE OF MR. ANDREW V. STOUT, REDBANK, N. J.
JOHN RUSSELL POPE, ARCHITECT

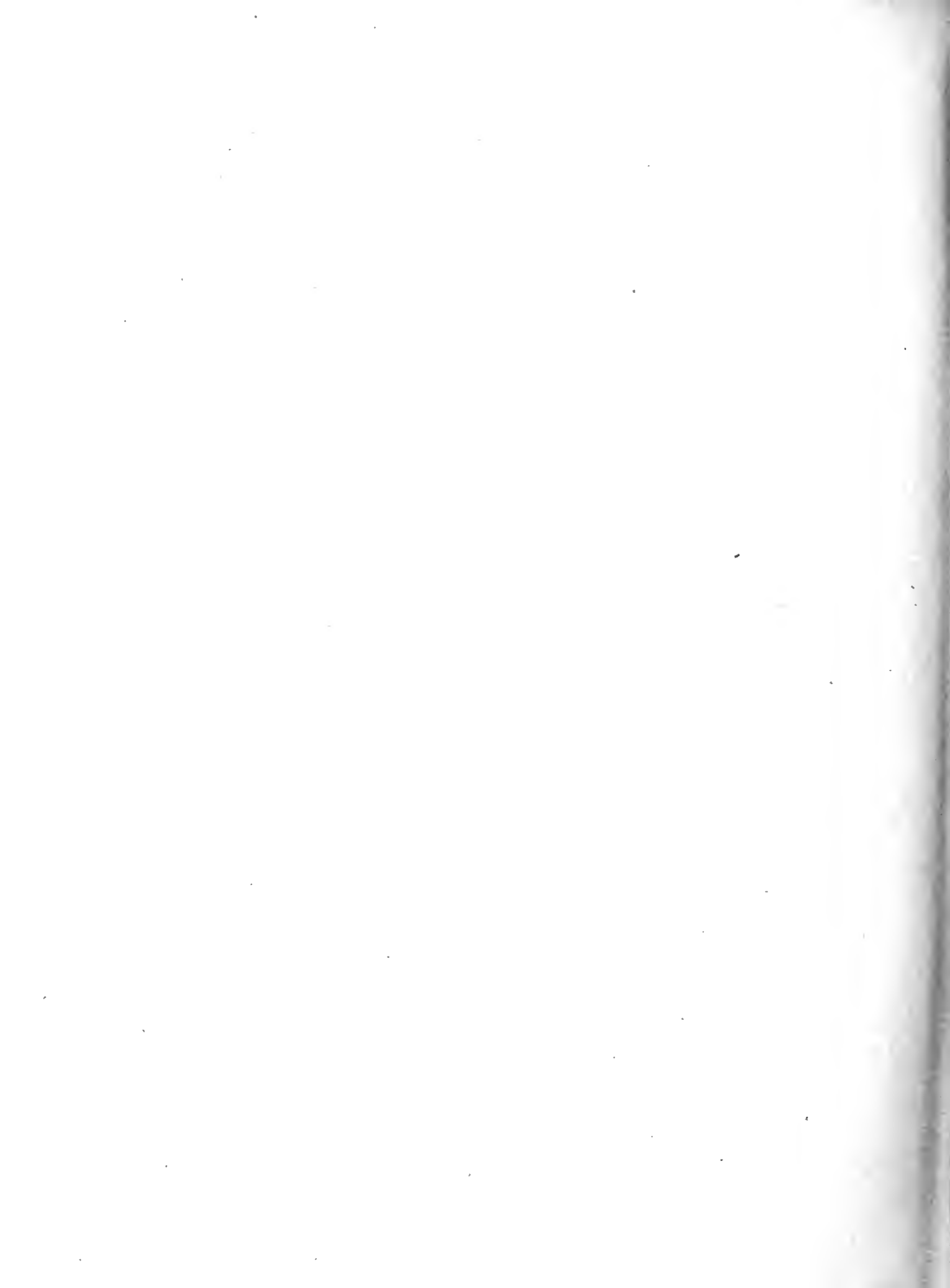

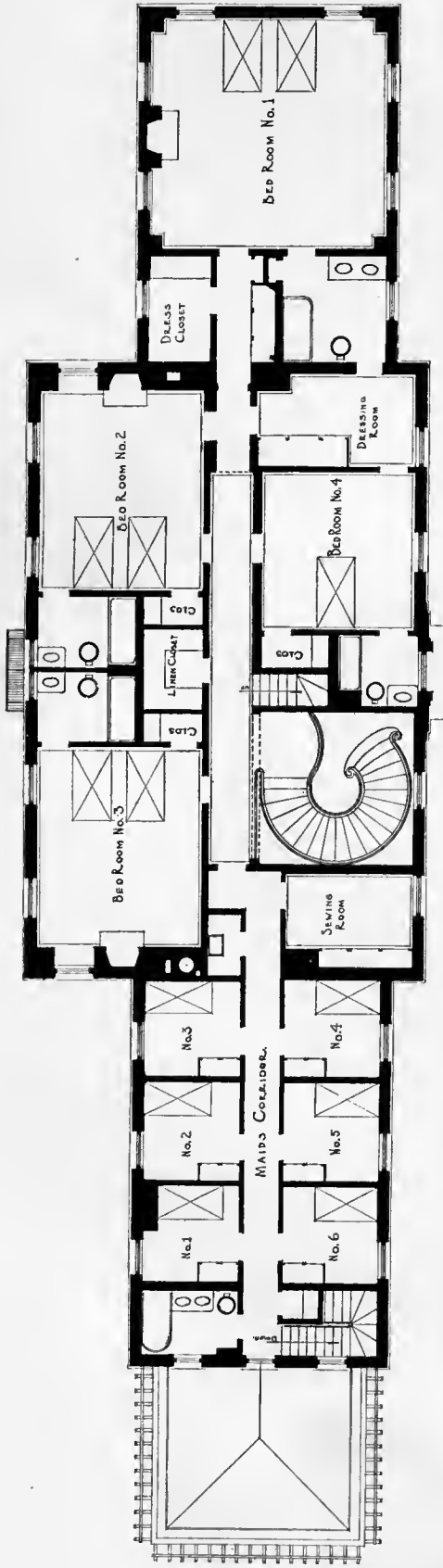

SECOND FLOOR PLAN

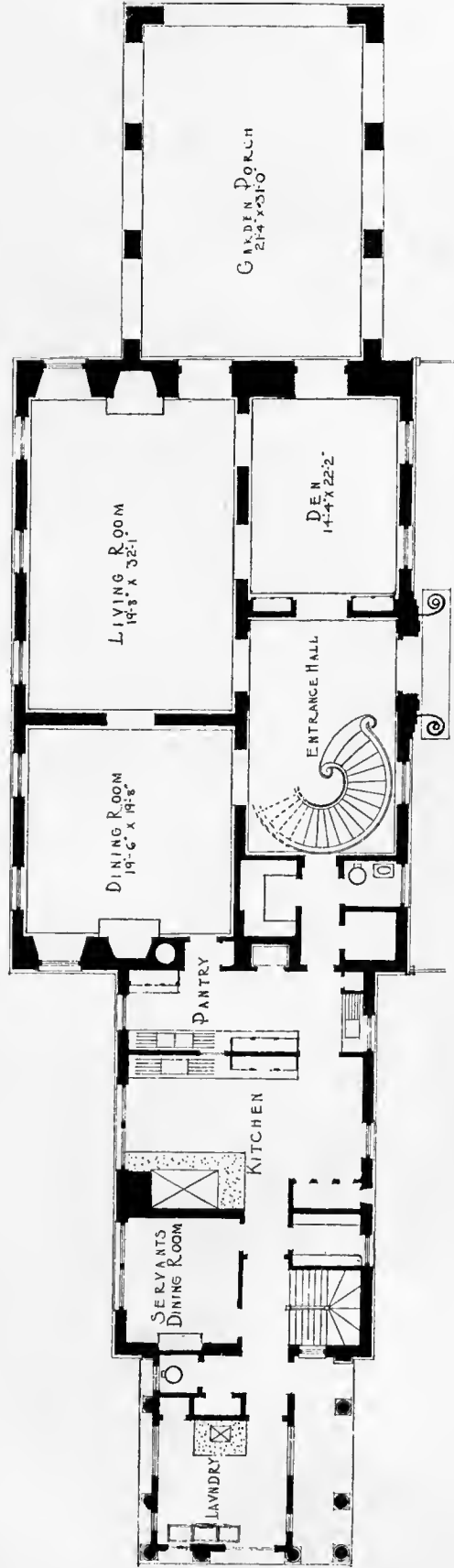

FIRST FLOOR PLAN

HOUSE OF MR. ANDREW V. STOUT, REDBANK, N. J.
JOHN RUSSELL POPE, ARCHITECT

586 2



REAR VIEW

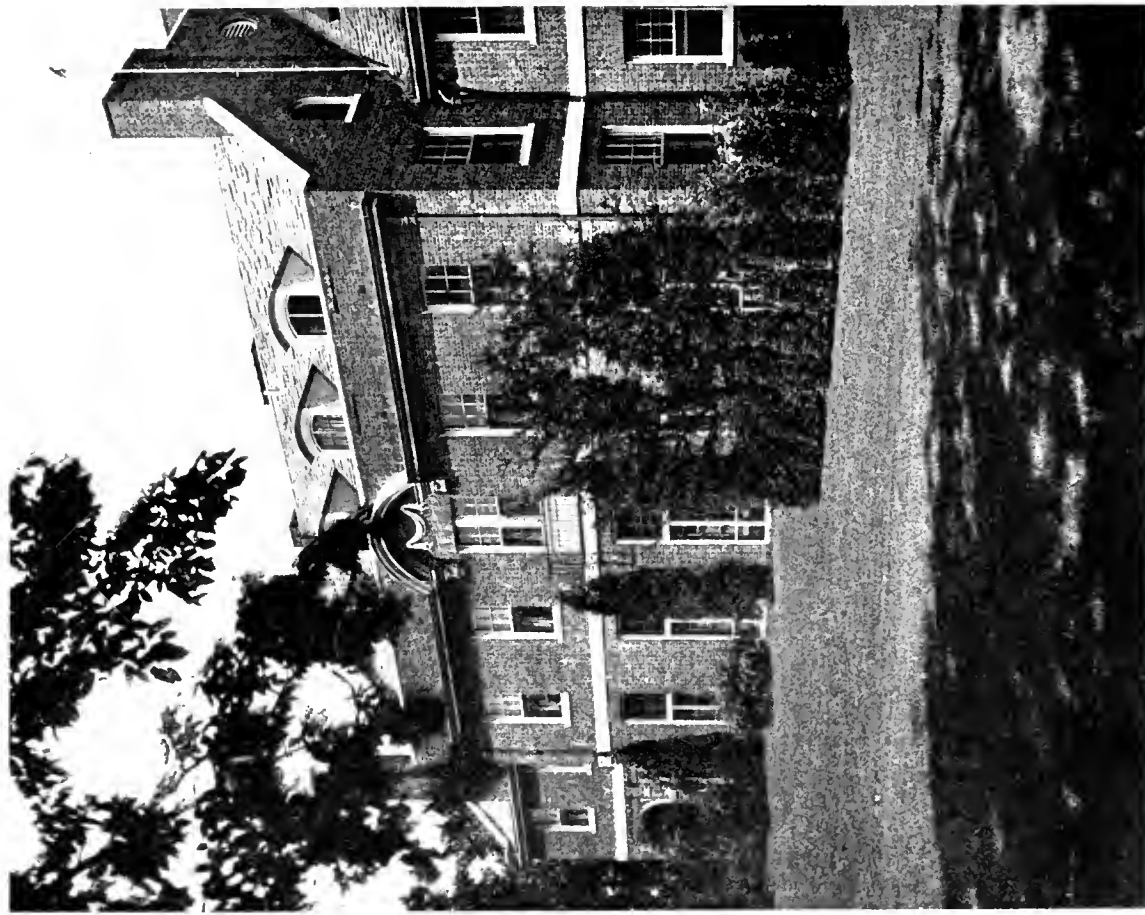

GARDEN FRONT

HOUSE OF MR. ANDREW V. STOUT, REDBANK, N. J.
JOHN RUSSELL POPE, ARCHITECT

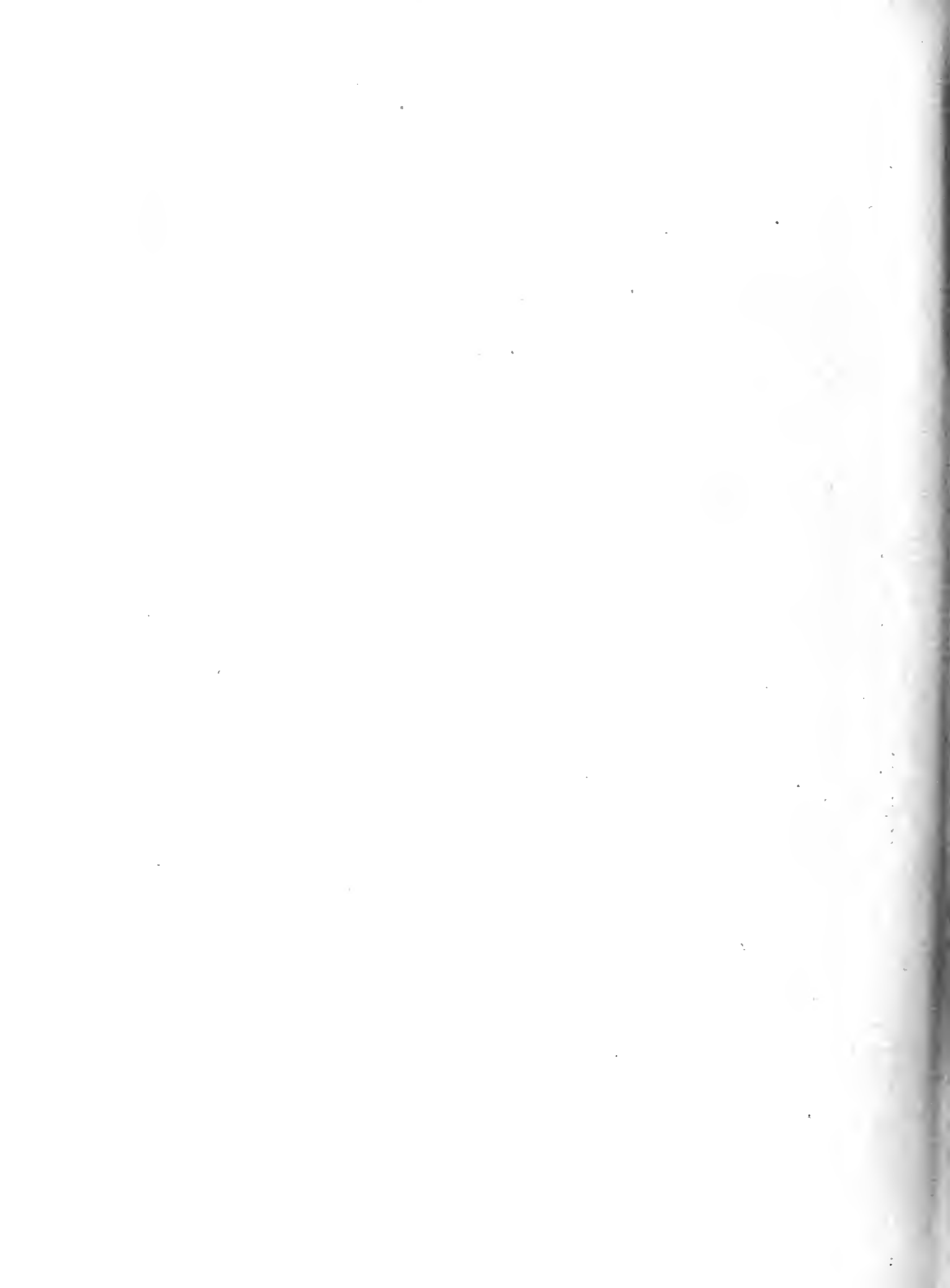

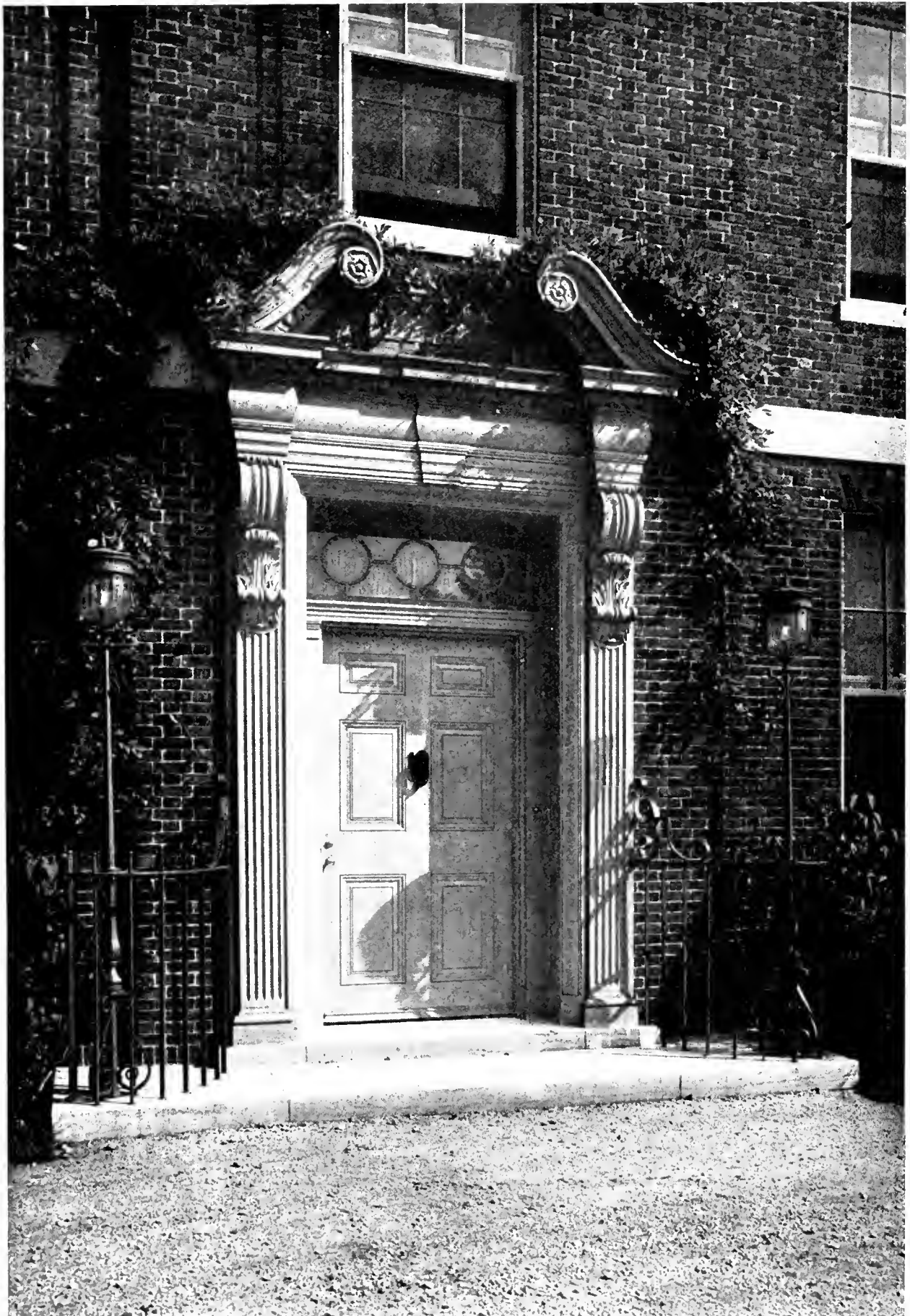

ENTRANCE DOOR
HOUSE OF MR. ANDREW V. STOUT, REDBANK, N. J.
JOHN RUSSELL POPE, ARCHITECT

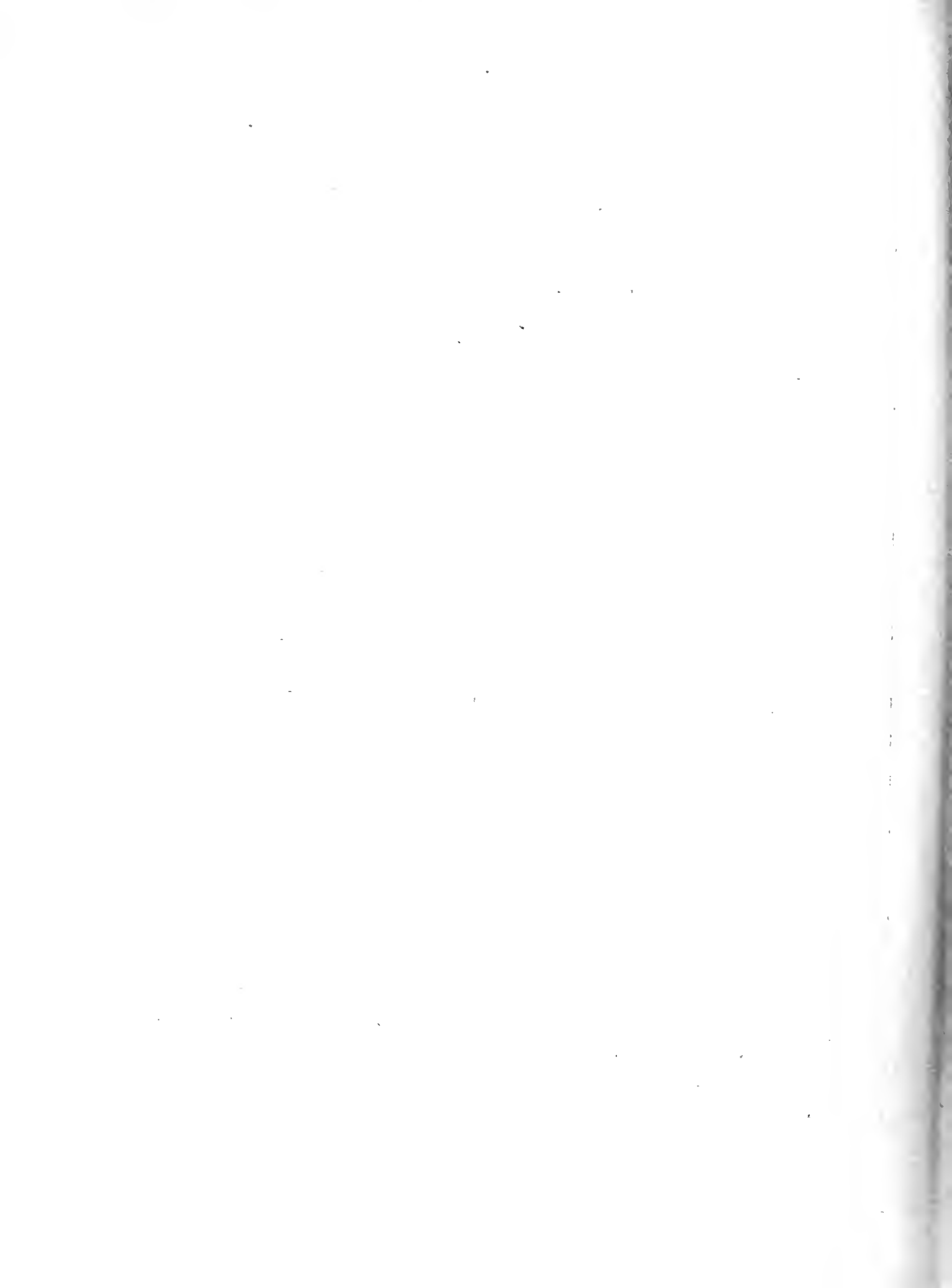



STAIRWAY
HOUSE OF MR. ANDREW V. STOUT, REDBANK, N. J.
JOHN RUSSELL POPE, ARCHITECT

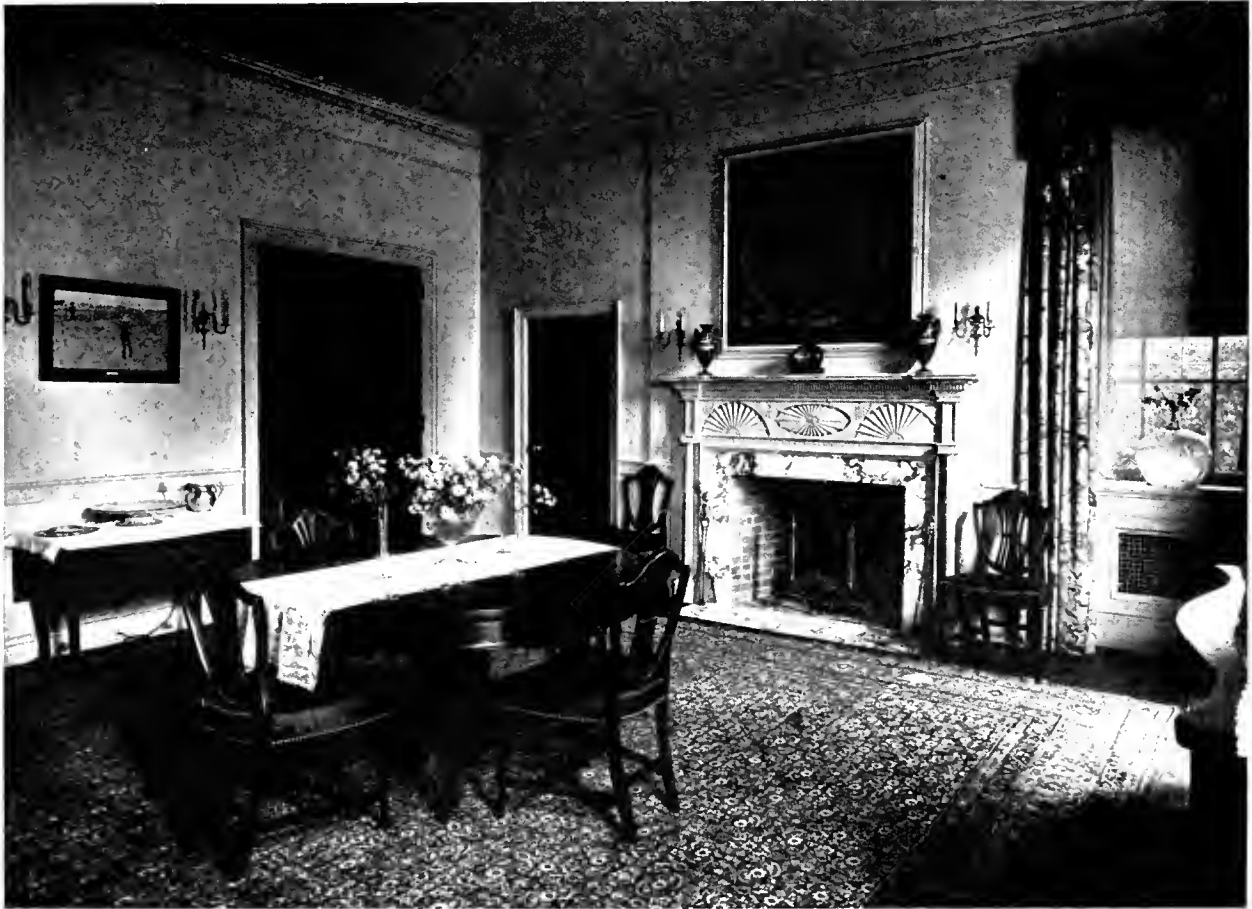

DINING ROOM



LIBRARY

HOUSE OF MR. ANDREW V. STOUT, REDBANK, N. J.





DINING ROOM FIRE PLACE
HOUSE OF MR. ANDREW V. STOUT, REDBANK, N. J.
JOHN RUSSELL POPE, ARCHITECT





LIVING ROOM FIRE PLACE
HOUSE OF MR. ANDREW V. STOUT, REDBANK, N. J.
JOHN RUSSELL POPE, ARCHITECT

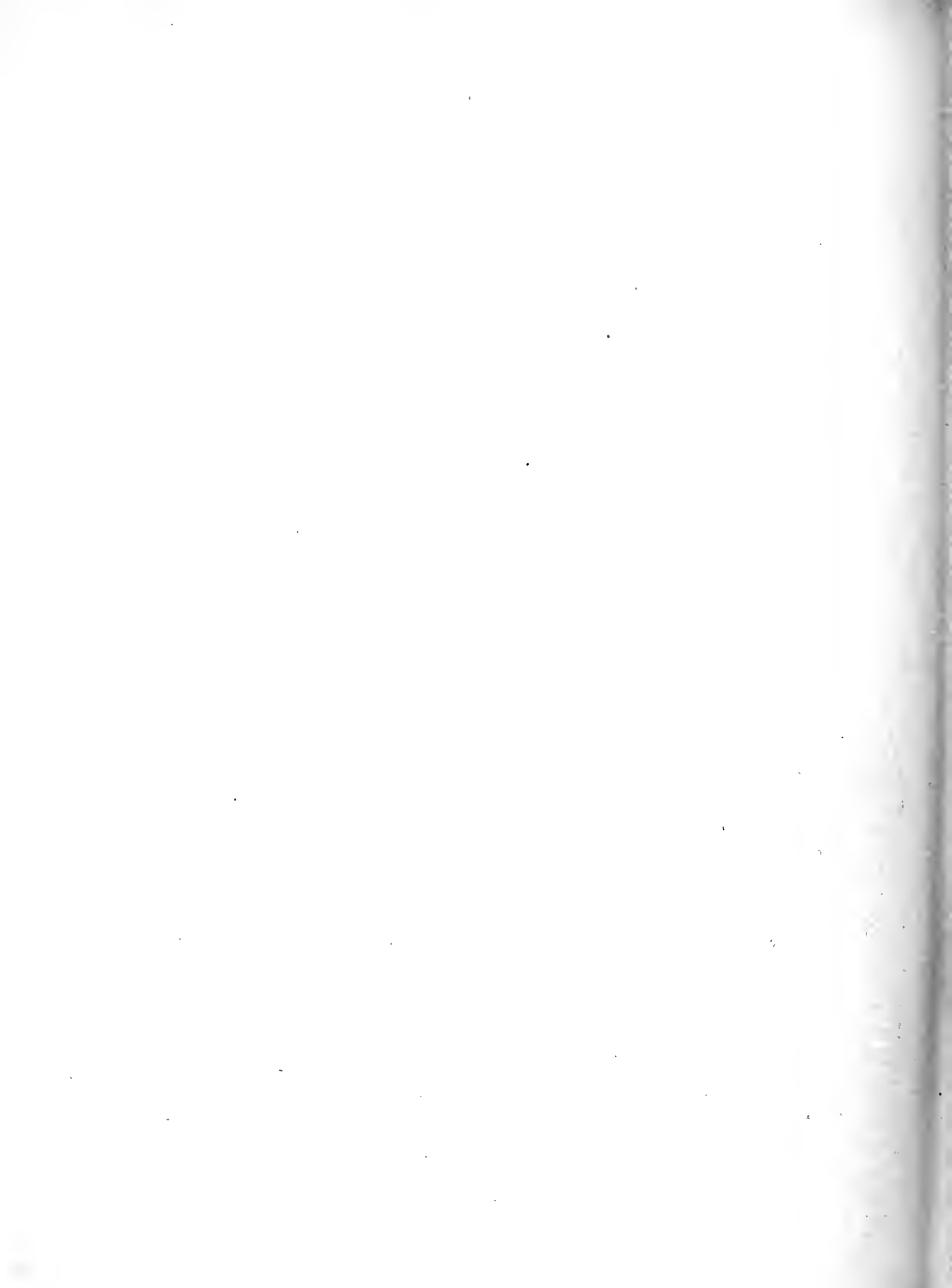



MENDLESON MEMORIAL CHAPEL, LOUDENVILLE, N. Y.
LEWIS COLT ALBRO, ARCHITECT

5861



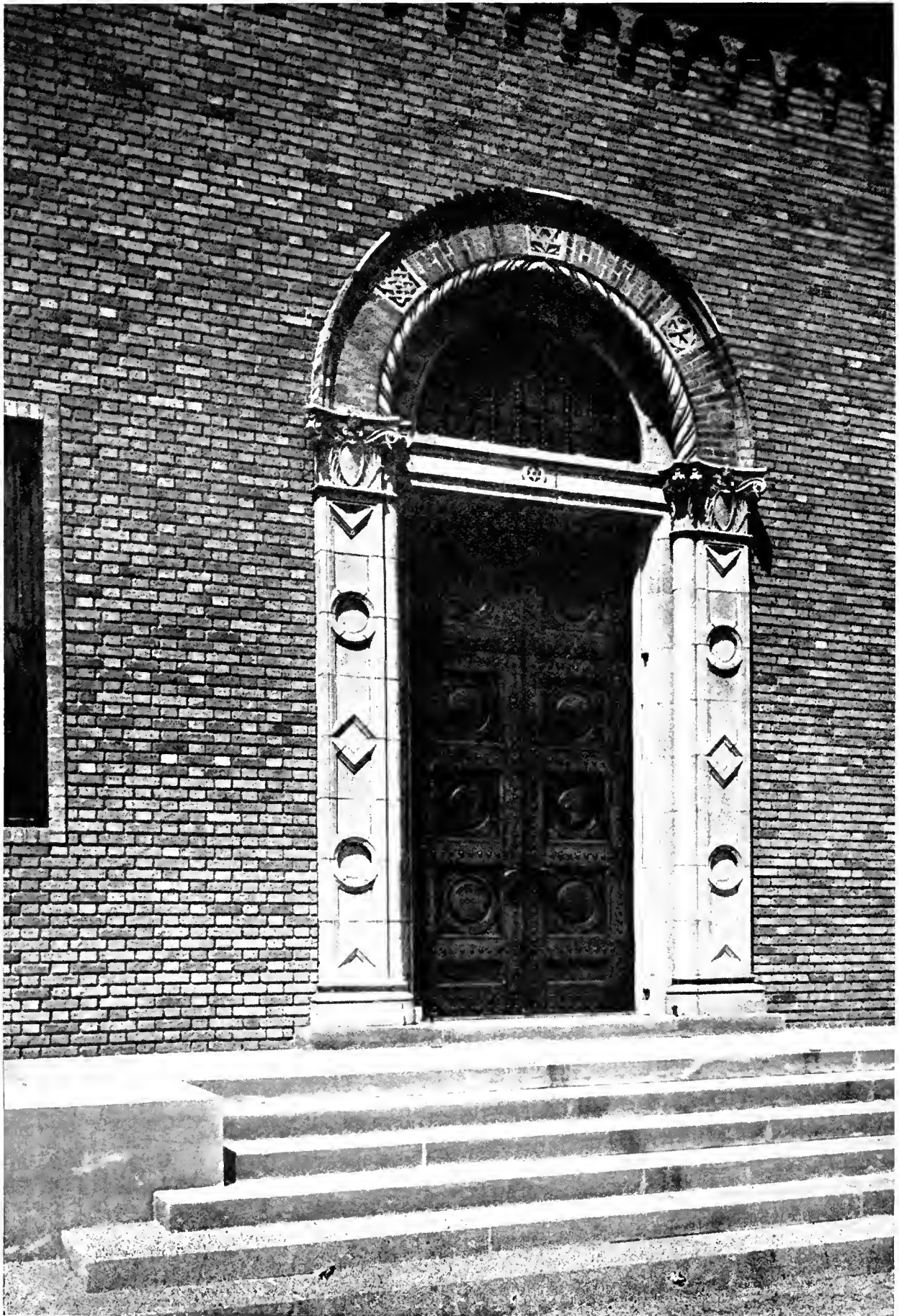

MENDLESON MEMORIAL CHAPEL, LOUDENVILLE, N. Y.
LEWIS COLT ALBRO, ARCHITECT





HOUSE OF MR. B. AUSTIN CHENEY, NEW HAVEN, CONN.
ROSSITER & MULLER, ARCHITECTS

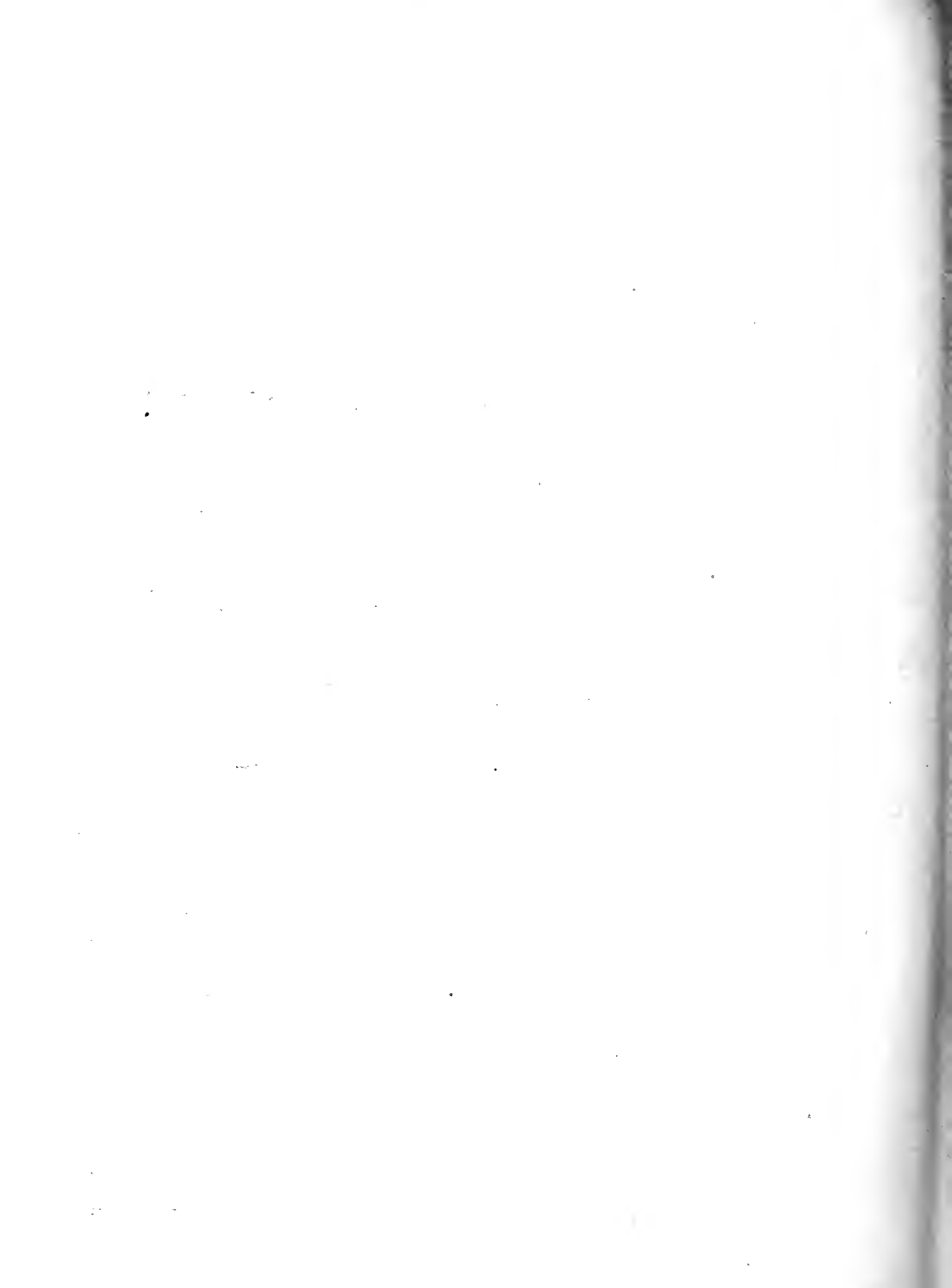

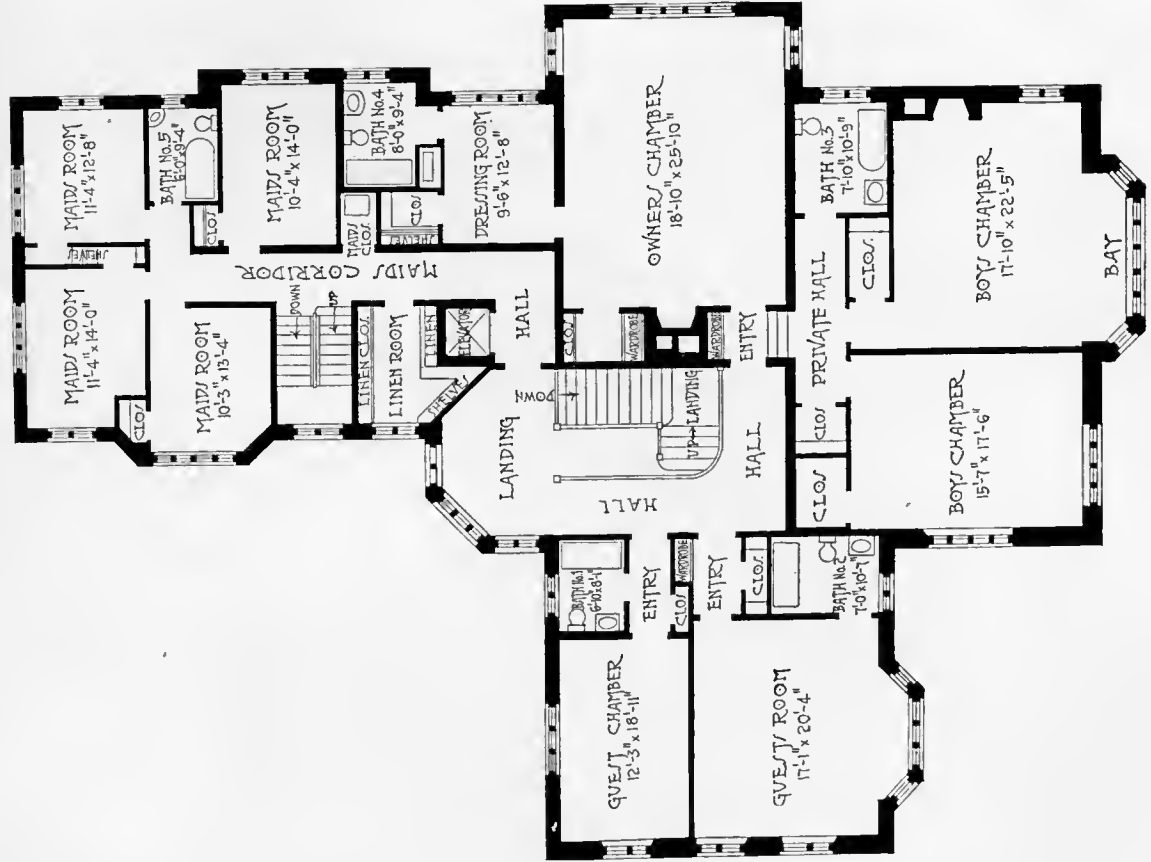
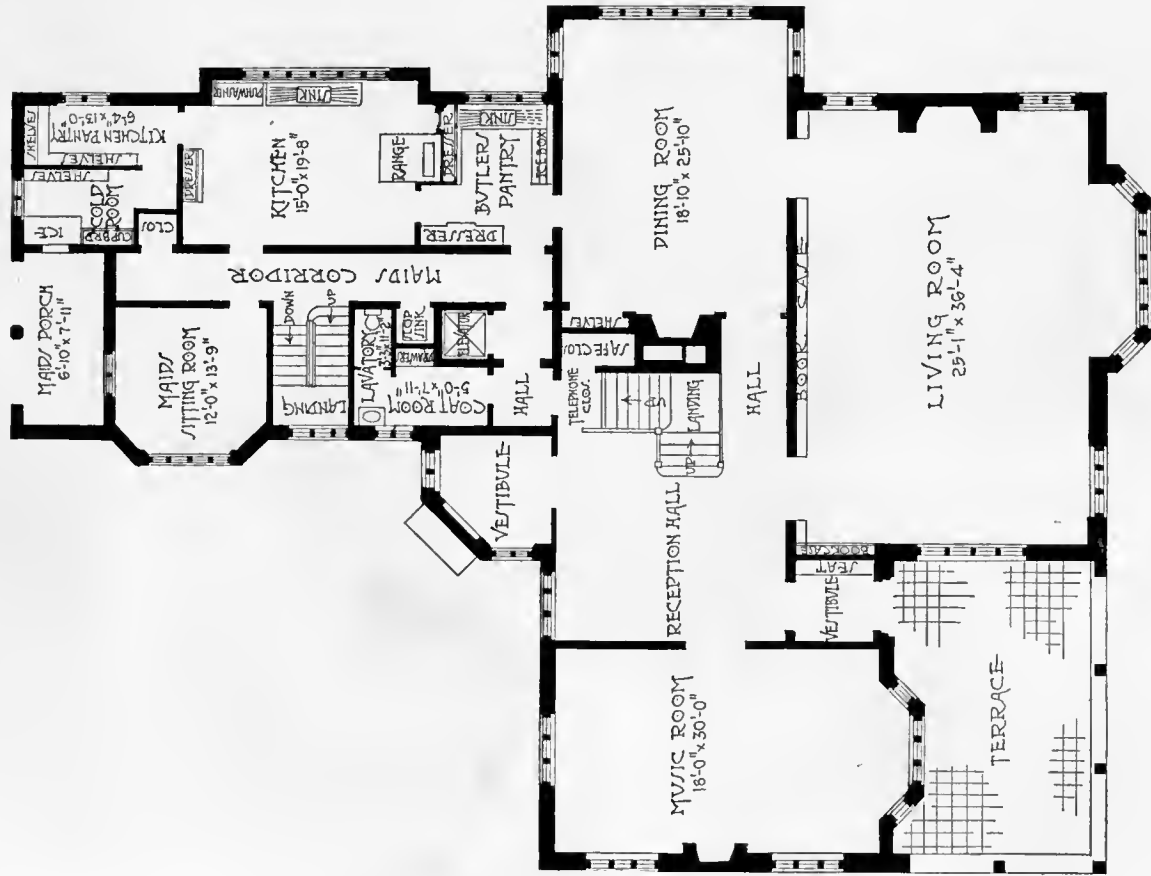

HOUSE OF MR. B. AUSTIN CHENEY, NEW HAVEN, CONN.
ROSSITER & MULLER, ARCHITECTS

586 12

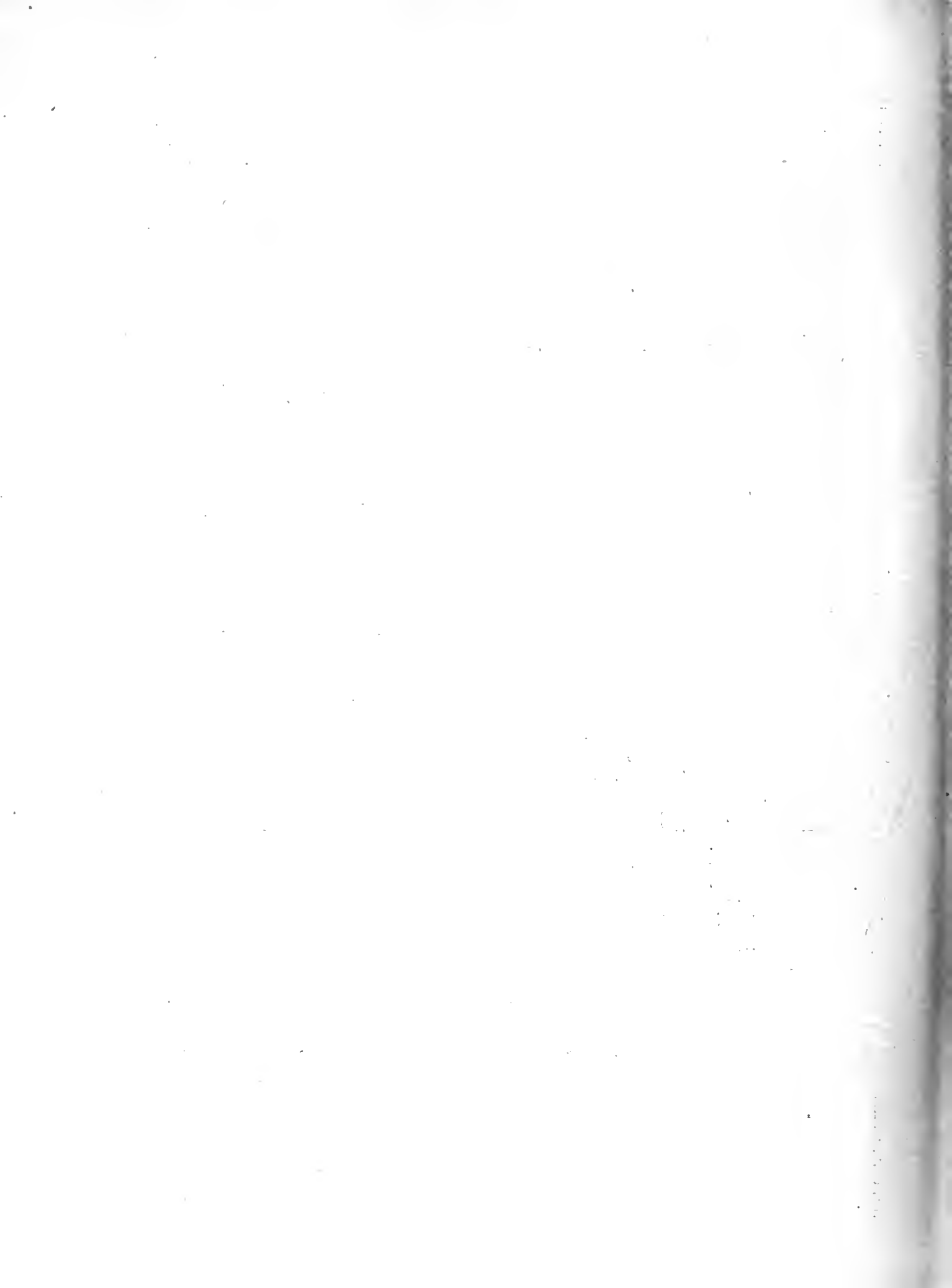

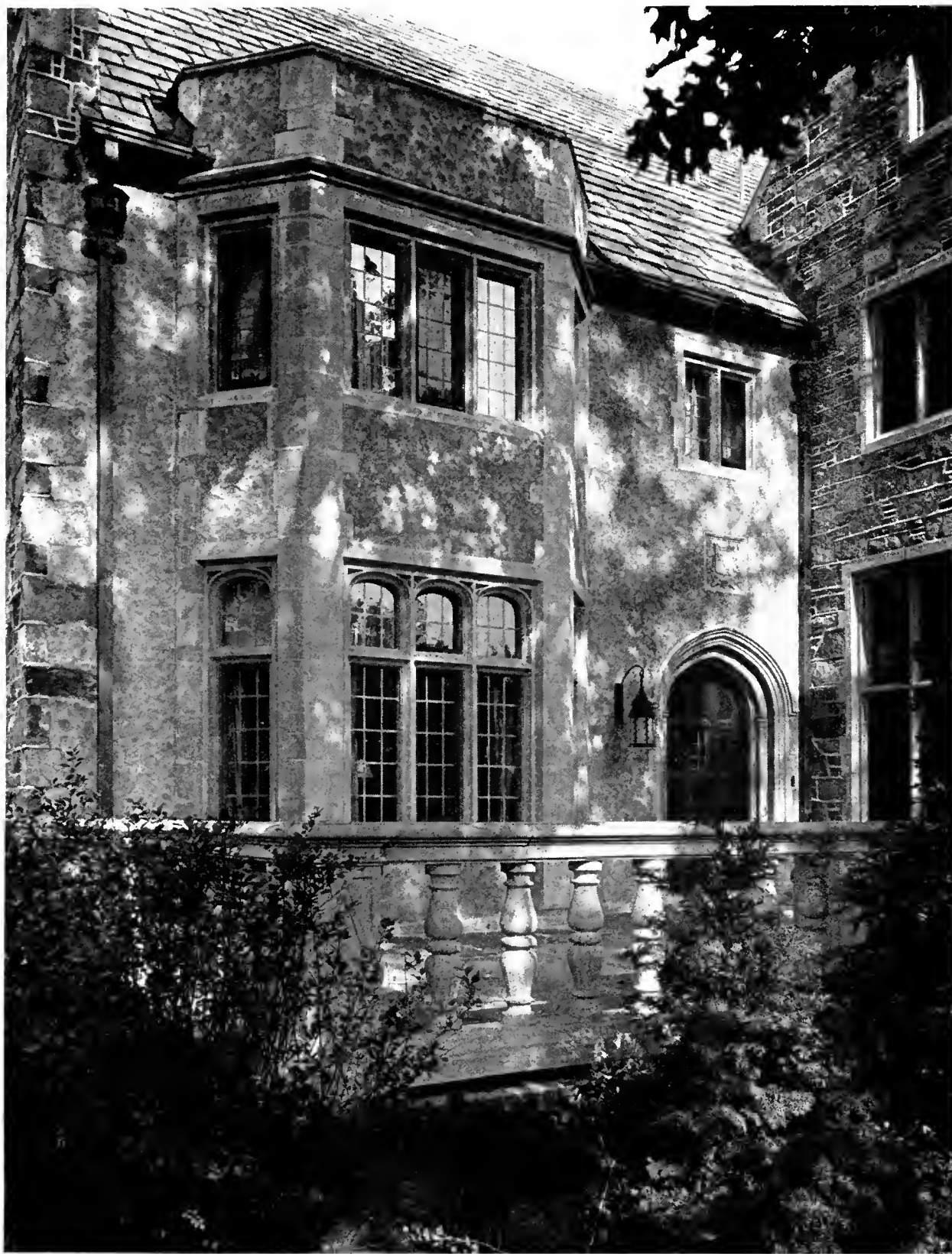

HOUSE OF MR. B. AUSTIN CHENEY, NEW HAVEN, CONN.
ROSSITER & MULLER, ARCHITECTS



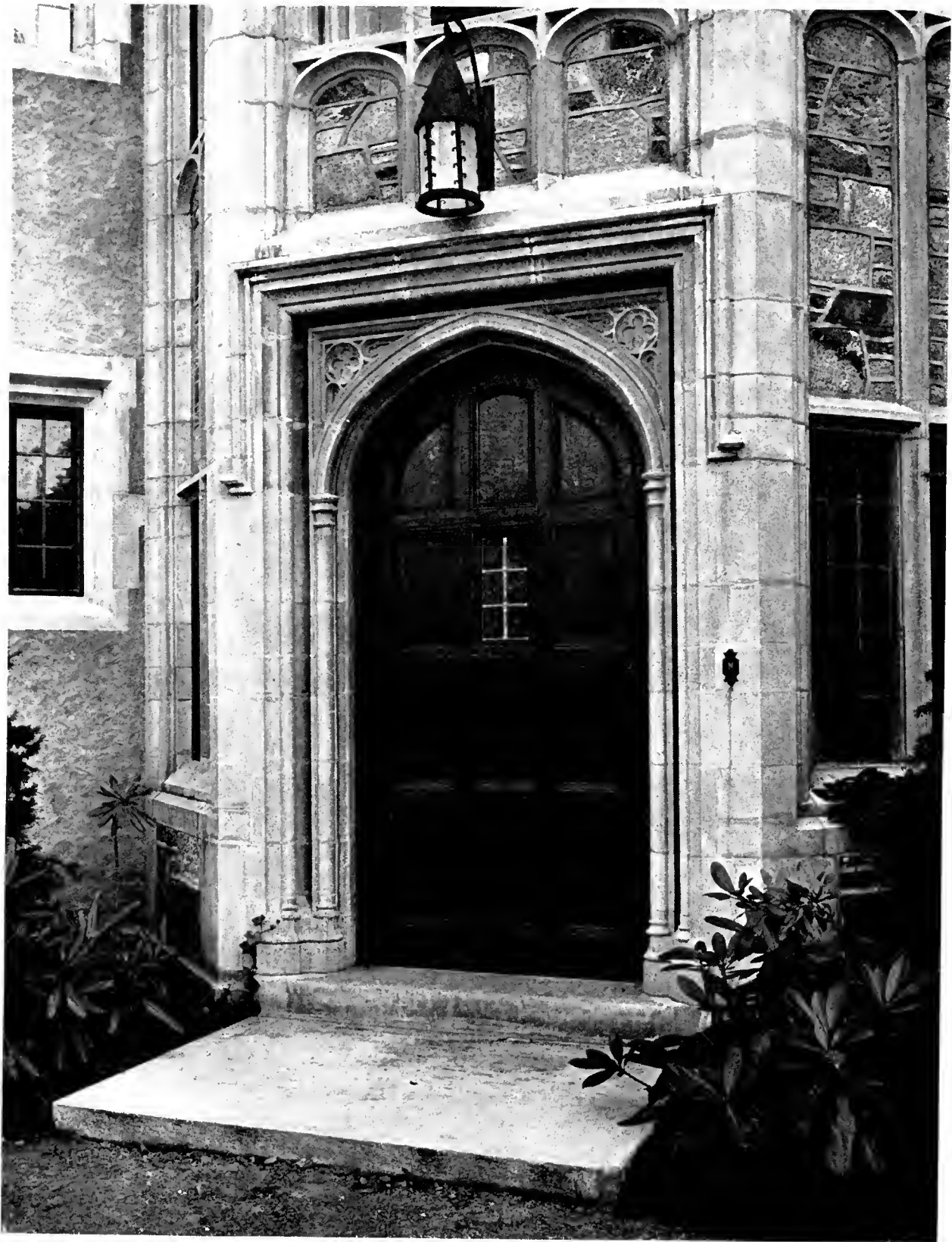

HOUSE OF MR. B. AUSTIN CHENEY, NEW HAVEN, CONN.
ROSSITER & MULLER, ARCHITECTS



HOUSE OF MR. B. AUSTIN CHENEY, NEW HAVEN, CONN.
ROSSITER & MILLER, ARCHITECTS



16
586



LOFT BUILDING, FOURTH AVENUE AND 19TH STREET, NEW YORK
ROBERT D. KOHN, ARCHITECT

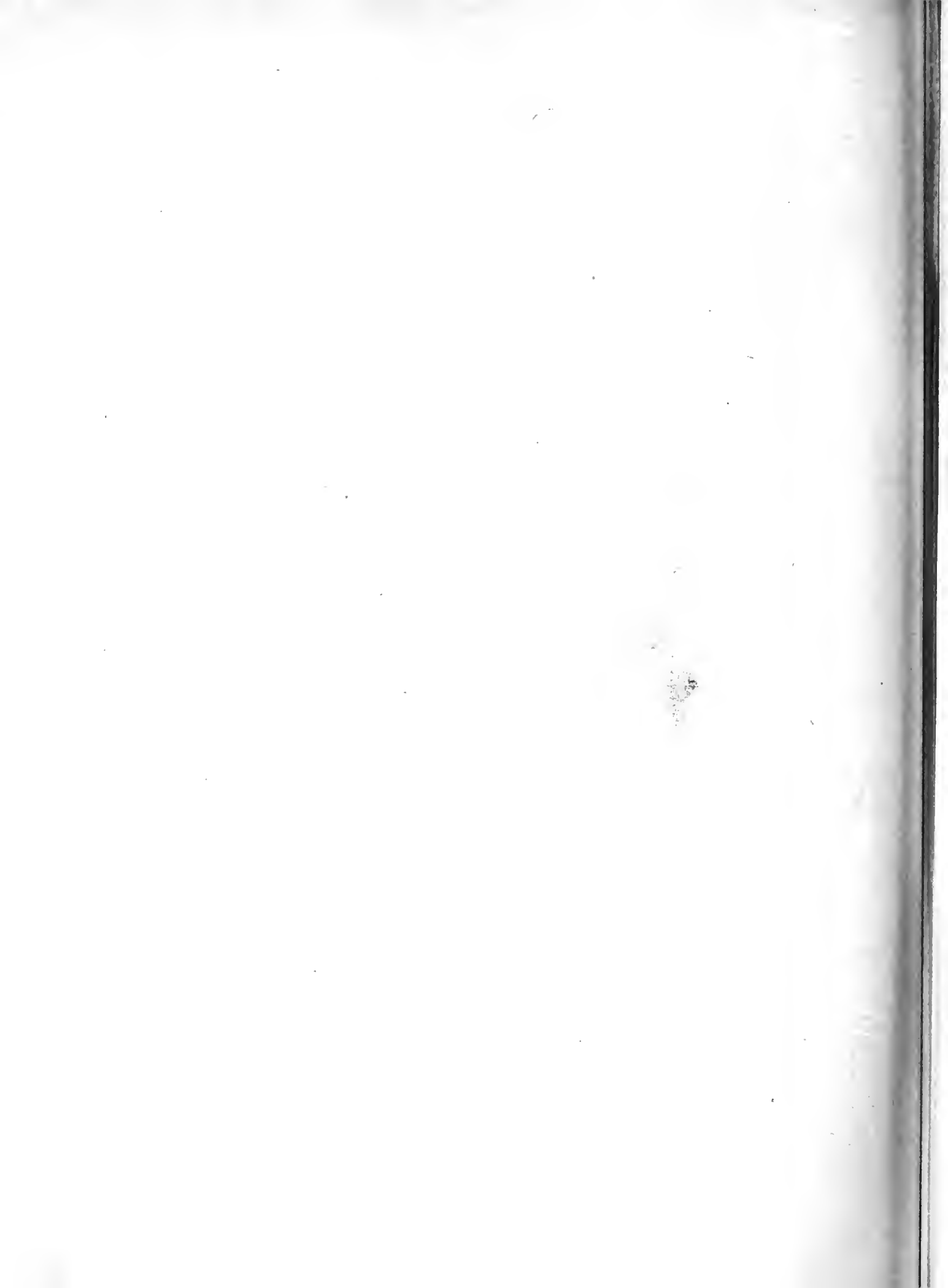

DEPARTMENT OF ARCHITECTURAL ENGINEERING

REFRIGERATION Part Two

By CHARLES L. HUBBARD

A COMPARISON OF DIFFERENT SYSTEMS

AS in other forms of mechanical equipment each system has its advantages and disadvantages, depending upon such conditions as cost of installation and operation, whether exhaust steam is available as a by-product, size and use of plant, temperature required, etc.

While both compression and absorption systems are used in nearly all classes of work, the former is more frequently employed for medium temperatures and the latter for extremely low temperatures. Both systems are used in cold storage warehouses, sometimes one to the exclusion of the other and sometimes in connection, the absorption machine being used for that part of the work requiring the lower temperature. In freezing fish both types are successfully employed. In abattoirs, general practice makes use of the compression machine, also in air and water cooling, and in the manufacture of beverages where moderate temperatures are required. For hotels and restaurants, stores, markets, etc., both types are extensively made use of.

The small portable machines designed for residences and light commercial work are practically all of the compression type. Based on steam consumption alone, the absorption machine appears to be more economical than the simple compression machine, but with the compound compressor the results are reversed. The particular field of the absorption machine is in plants where exhaust steam is available for use in the generator and where extremely low temperatures are required.

The combined compression and absorption system utilize three conditions which tend toward greater economy. First, the efficiency of the compression machine increases with increased suction pressure; that is, raising the suction pressure increases the tonnage or output of the machine at a faster rate than it does the horsepower required to operate the



FIG. 11

compressor. It is not possible, however, to take advantage of this beyond certain limits because a high suction pressure in a compression machine prevents low temperature in the refrigerator.

Second, the efficiency of an absorption machine increases with decreased generator pressure, but this is limited in practical work because a low generator pressure calls for cooling water of unobtainably low temperature. Now, by combining the two systems, these conditions which make for efficiency, and which are not available separately, are easily realized, as will be seen by referring to Fig. 6. For example, suppose we have a compression machine and an absorption machine operating independently, each with a suction pressure of 15 pounds and a discharge or condenser pressure of 150 pounds. Now we may combine these as shown in Fig. 6, and lower the discharge pressure from the generator of the absorption

*Part one will be found in issue of April 27, 1921.

machine from 150 to 70 pounds, which, at the same time, increases the suction pressure of the compression machine from 15 to 70 pounds, thus obtaining the condition sought in the case of each unit, without changing the actual pressure range of the combined machine, which is 15 to 150 pounds, as before.

Computations show that raising the suction pres-

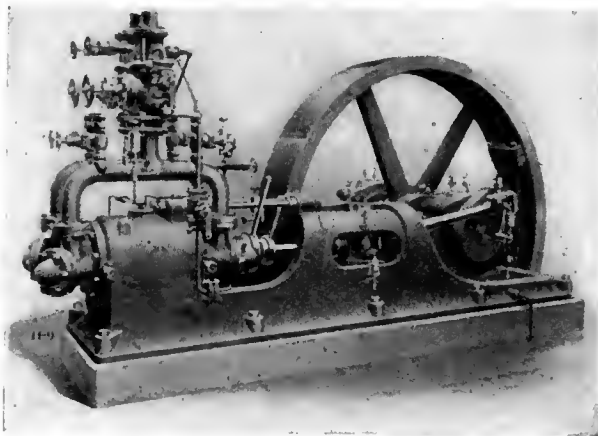

FIG. 12

sure from 15 to 70 pounds on a compression machine, having a condenser pressure of 150 pounds, will more than double the tonnage or output without increasing the horsepower required to drive the compressor.

With the combined machine this may be done without the sacrifice of low temperature in the expansion or refrigerating coils and without any change in the temperature of the cooling water.

The third condition mentioned, relating to increased efficiency, is the possible utilization of the exhaust steam from the compressor in the generator of the absorption machine. This is an important item in independent plants not associated with power work, in which case it would be necessary to use live steam in an absorption machine or throw away the exhaust from a steam-driven compressor. In the illustration given, we have shown how the output may be doubled without increasing the horsepower, which,

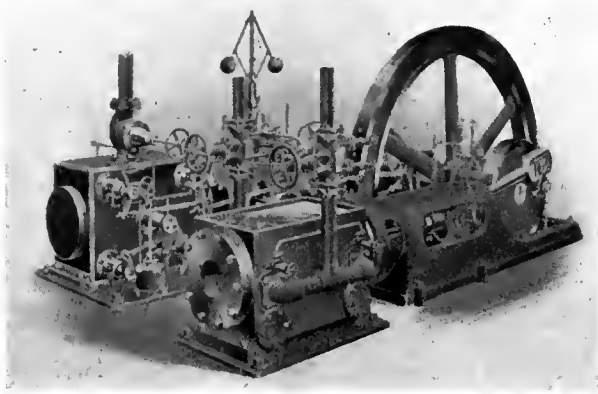

FIG. 13

of course, means that the same output may be realized with one-half the power. In case of a new combined installation this would call for a compressor only one-half the size of that necessary in an ordinary compression system of the same capacity. When both compression and absorption systems are used in the same plant, independently, they may be combined to the extent of utilizing the exhaust from the compressor engine in the generator of the absorption machine, by a simple change in the piping, thus operating the latter system on steam which might otherwise be wasted.

DISTRIBUTING SYSTEM

This refers to the method of transmitting the refrigerating effect from the machine to the space or liquid to be cooled. In the *direct* system the expansion coils are placed where the cooling is desired, as in Figs. 1 and 4, and the latent heat of vaporization drawn directly from the surrounding air. This is the simplest arrangement and the one most widely used in systems of small and medium

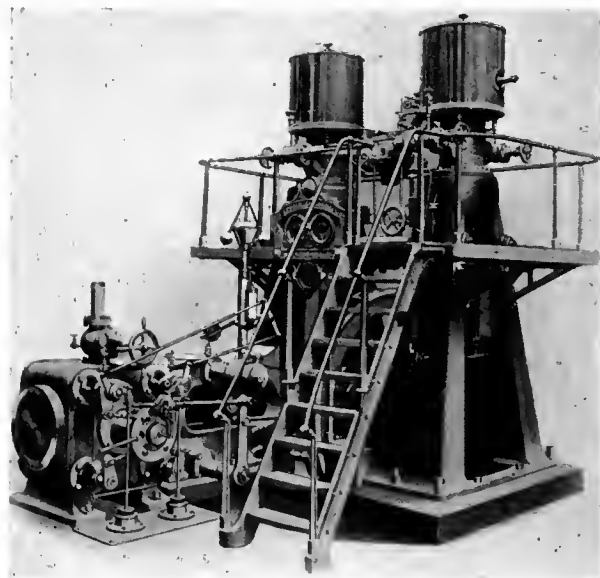

FIG. 14

size. The two objections to this are as follows: First, in case of leaks in the expansion coils, the escaping ammonia gas passes directly into the storage rooms. Second, the extremely low temperature to which the coils are exposed, and the moisture in the surrounding air, cause frosting of the pipes, which not only reduces the transmission and thus lessens the cooling effect in the room, but also cuts down the vaporization of ammonia gas and may cause the excess of liquid ammonia to flood over into the compressor or absorber. However, with proper design and operation these difficulties may be practically overcome, and the absence of brine pumps, coolers, foundations, etc., makes this system cheaper to install and simpler to operate.

In the brine system, shown in Fig. 3, the expansion coil is placed in a tank of brine and the latter pumped through the cooling pipes. This eliminates the possibility of gas escaping into the storage rooms and either reduces or does away entirely with frosting, according to the temperature of the brine circulated through the cooling pipes. Furthermore, there is a certain amount of "cold" stored in the brine which may be utilized for a short time by keeping it in circulation after the main machine has been shut down. This is sometimes a convenience in case of a breakdown and repairs to the refrigerating side of the plant, and is also made use of to some extent in the *congealing tank* systems to be mentioned later.

On the other hand, the brine tank and pump complicates the system to some extent and adds to the cost of operation through loss of heat from piping and apparatus outside of the cold rooms, and power required for running the circulating pumps. How-

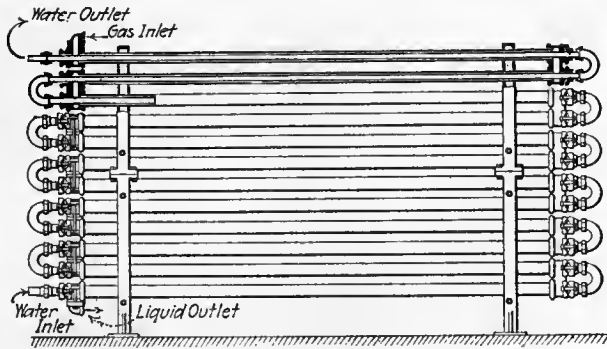

FIG. 15

ever, the objectionable features in both systems may be largely eliminated and the arrangement used which seems best adapted to the case in hand.

POWER FOR OPERATION

The unit of refrigeration is commonly taken as the cooling effect produced by the melting of 1 ton of ice per twenty-four hours, and is called 1 ton of refrigeration. This is equal to the cooling pro-

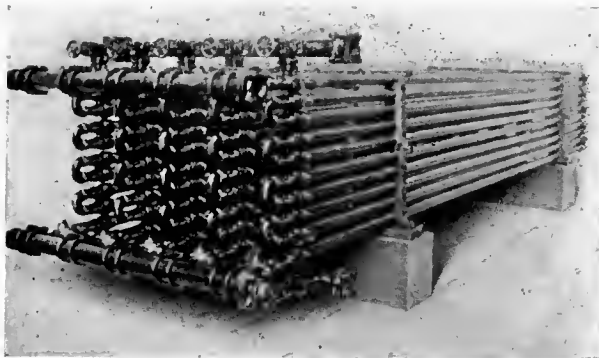

FIG. 16

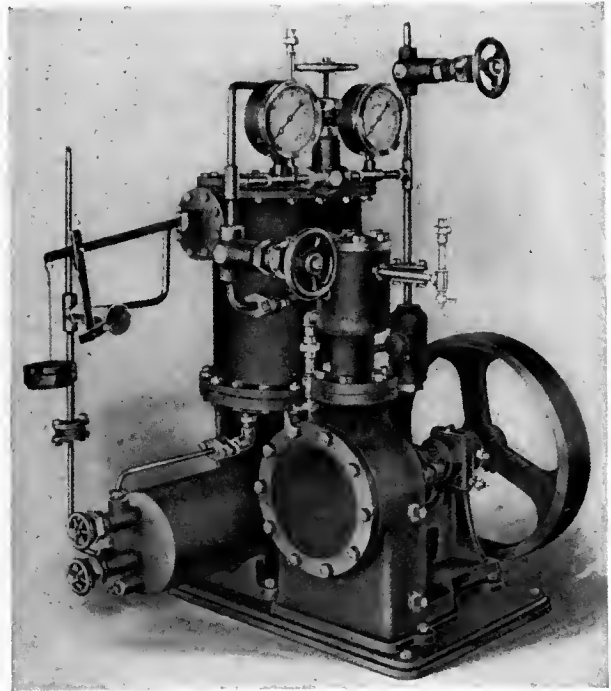

FIG. 17

duced by the melting of $\frac{2,000}{24} = 83.3$ pounds of ice per hour.

To melt 1 pound of ice into water at the same temperature (32 deg. F.) requires 144 thermal units, which is called the latent heat of fusion, and strictly speaking, the unit of refrigeration is the amount of heat absorbed by the melting of 1 ton of ice or $2,000 \times 144 = 288,000$ T.U. The capacity of a machine expressed in tons per twenty-four hours is therefore the *rate* of refrigeration rather than the unit, as commonly expressed.

The brake horsepower per ton of refrigeration for compression machines will depend largely upon the size and type. The figures given by different engineers vary somewhat and it has seemed best to take the average of several. The quantities in Table I refer to tons of *refrigerating effect* per twenty-four hours and not to tons of *ice*.

Table I.

Rating of machine in tons of refrigeration per 24 hours:	Brake horsepower per ton of refrigeration for operating compressor:
1 to 5	2
5 to 10	1.8
10 to 20	1.7
20 to 30	1.6
30 to 40	1.5
40 to 50	1.4
50 to 100	1.3
100 to 150	1.2

When the machine is to be motor driven, the

THE AMERICAN ARCHITECT

capacity of the motor may be taken from the above table. If the compressor is of the steam-driven type, and it is desired to determine the necessary boiler power, we may allow the following quantities of steam per brake horsepower per hour for different types of engines, as given in Table II.

Table II.

Type of Engine	Pounds of steam per brake horsepower —per hour—	
	Simple	Compound
High-speed, single-valve.	34	28
High-speed, four-valve.	31	26
Medium-speed, four valve.	29	24
Slow-speed, four-valve.	27	21

After computing the pounds of steam required per hour by the engine, divide the result by 30, to find the boiler horsepower.

Example: What boiler horsepower will be required to operate a compression system of refrigeration rated at 50 tons capacity, equipped with a simple, medium-speed, four-valve engine?

Solution: From Table I we find a 50-ton compressor requires 1.4 brake horsepower per ton, or a total of $50 \times 1.4 = 70$ horsepower, which for the

$$\text{type of engine assumed calls for } \frac{70 \times 29}{30} = 67$$

boiler horsepower.

TYPES OF COMPRESSORS

These are made in a variety of forms, depending upon the size and service required. A typical belt-driven compressor of small size is shown in Fig. 11, and illustrates the general form of machine used with the small portable and semi-portable outfits commonly installed in dwelling houses, grocery stores, markets, etc. A larger machine, of the horizontal type, is illustrated in Fig. 12. Both of these are belt-driven, an electric motor being generally used for the smaller sizes and either a motor or engine for the larger, as most convenient. A horizontal compressor driven by a direct-connected four-valve engine is shown in Fig. 13 and illustrates a type of machine used in plants of medium to large size. A double vertical compressor, driven by a horizontal Corliss engine, is shown in Fig. 14 and represents an outfit of large size. Vertical compressors require less floor space than the horizontal type, but are not so accessible in case of repairs.

CONDENSERS

Condensers for liquefying the gas after it leaves the compressor or generator are of three general types, known as the *submerged*, *atmospheric*, and *double-tube*. The principle of the first has already been shown in Figs. 1 and 4. It is the older form, and is not generally used to any extent in new work at the present time, except in certain

makes of small portable machines. The atmospheric condenser consists of a series of return bend coils mounted upon the roof of a building. The outside of the pipes are kept constantly wet, and the evaporation thus produced absorbs the heat from the ammonia gas within and causes it to condense. Condensers of this form are used principally in plants of large size and where the cooling water contains impurities which will deposit a scale at temperatures below 100 deg. The double-tube condenser, shown in Fig. 15, is compact, efficient, and recommended where the cooling water does not contain scale-producing properties. This type is usually furnished with most small and medium size plants and is easily

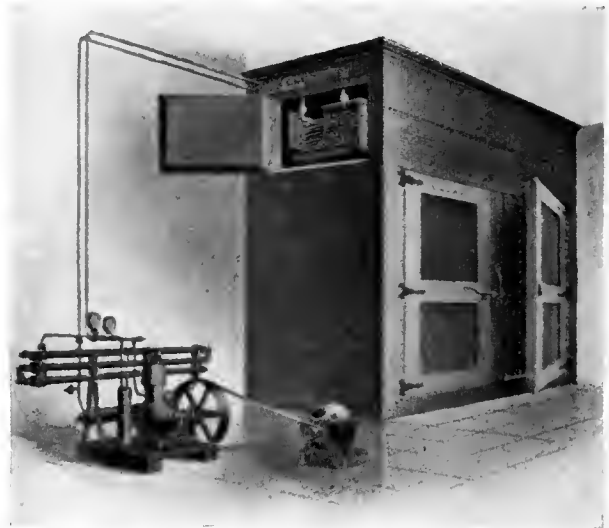

FIG. 18

mounted upon a building wall or on the side of a refrigerator or ice tank. In the construction of this device the cooling water flows through a pipe of smaller size carried inside the ammonia pipe, as indicated, the arrangement being such that the contents of the two pipes flow in opposite directions. As the temperature of the outer pipe containing the ammonia is usually equal to, or above, that of the room in which it is located, condensation of moisture from the air, and consequent dripping are avoided. A large condenser of this type, made up of several sections, is illustrated in Fig. 16.

BRINE COOLERS AND PUMPS

In the brine system special coolers are required for lowering the temperature of the brine before it is pumped through the coils in the refrigerators or storage rooms. These are made in two general forms, the most common being of the same general construction as the double-pipe condenser just described. The other form is a tank of large capacity with double cooling coils, and used in plants where low temperatures are required. The brine is usually circulated through the system by means of centrifugal pumps, although other types are frequently employed.

ROOM TEMPERATURES FOR STORAGE PURPOSES

This depends largely upon the nature of the goods in storage and may be regulated by the quantity of liquid ammonia admitted to the expansion coils. For the freezing of meat and fish a temperature of 0 to + 10 deg. is required, depending upon the rapidity desired. For storage in a frozen condition, this may be raised to 10 or 20 deg. above zero. Temperatures for the storage of other articles are given in Table III.

Table III.

	Temperature— in deg. F.
Butter, held over long periods.....	0— 5
Butter, ordinary storage.....	15—20
Cheese	32—34
Eggs	32—34
Canned goods	35—40
Fruit	34—38
Vegetables	35—40
Tonic beverages	35—36
Flour and Meal.....	36—40
Maple Sugar and Syrup.....	40—45
Cigars and Tobacco	35—36
Furs and Woolens.....	35—36

ICE MAKING

Plants installed for storage purposes in hotels, restaurants, clubs, etc., are frequently equipped

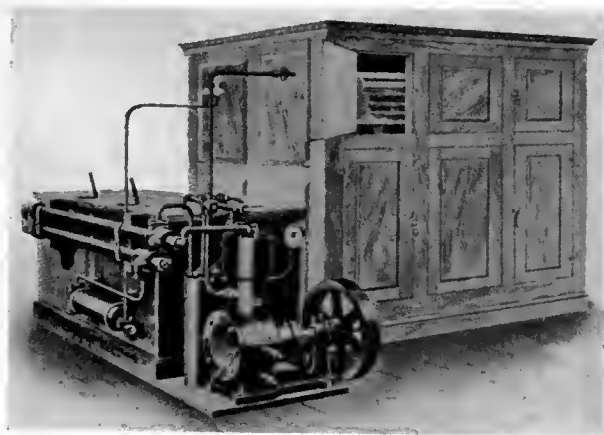

FIG. 19

for making ice also. In cases of this kind the so-called "can system" is employed, in which the water is frozen in galvanized iron cans placed in a tank of brine, which is maintained at a temperature well below the freezing point, by means of ammonia expansion coils carried along the sides. When ice is made in connection with general refrigeration or cold storage, it is only necessary to provide an independent branch line, with expansion valve, leading from the ammonia receiver to the coils in the freezing tank, thus operating the two systems at such

different temperatures as may be required. The power required per ton of ice is considerably more than for a ton of refrigeration, owing to various wastes and heat losses brought about by the process, and it is customary to increase the power from 60 to 100 per cent. to cover these.

REFRIGERATING OUTFITS

A few typical outfits of the portable type, adapted to dwelling houses, stores, markets, etc., are illustrated in Figs. 17 to 19. The first of these represents a complete compression machine of one-half ton capacity, including compressor, ammonia receiver, and condenser, the latter being of the submerged type, located just back of the compressor cylinder. This machine is driven by a belted motor, and is ready for connecting with the refrigerating coils and cooling water. A similar machine, equipped with a double-pipe condenser, and connected up with a refrigerator, ready for use, is shown in Fig. 18. A combination outfit for both refrigeration and ice making is illustrated in Fig. 19. The machine is mounted upon the same base with the freezing tank, while the refrigerator is shown at the right. This is made in sizes rated from 300 to 1,000 pounds of ice per twenty-four hours, and has cold-storage rooms 6 ft. x 5 ft. 8 in. x 9 ft. and 10 ft. x 10 ft. for the smallest and largest sizes respectively. These are typical of the many small outfits upon the market, and all capacities may be had up to those required for the largest hotels and department stores. As the size increases, the type of equipment takes on more the form of that employed in large commercial plants.

(To be continued)

Great Britain to Utilize Power from Tides

A SCHEME to generate 500,000 electrical horsepower daily by harnessing the power of the tides has been completed by the civil engineering department of the British ministry of transport, states *The Improvement Bulletin*. It is an application of the French discovery for utilizing the tides.

The scheme proposed the erection of a dam two and a half miles in length in the estuary of the river Severn, from which it is estimated that 500,000 electrical horsepower could be generated at a cost of about a half penny per British standard unit. It is claimed by the experts that there will be sufficient energy thus developed to supply power to the whole of Wales, a large part of England, and the southern section of Scotland, and to electrify a good many English railway systems.

It will be remembered that the French method, which is the one adopted for harnessing the Severn tides, is the storage of water at high tide levels and its use to drive turbines in passing from high level to low levels

SHORING and UNDERPINNING the CENTRAL WAREHOUSE, CHICAGO

THE Central Warehouse is located at the northwest corner of Rush Street and the Chicago River. The failure of foundations caused a settlement of between 6 and 7 inches in the central portion of the south wall, the face of which near the dock level was about $2\frac{1}{2}$ inches out of line. The first row of interior columns settled between 3 and 4 inches. When this building was rebuilt after the Chicago fire, the dock line was moved south, and this wall and row of columns were placed in new, filled-in ground. The wall was supported on three rows of wooden piles, on which were placed 12 x 12 in. wooden caps and sills, and on these was built the stone foundation. The foundations for the columns were built in a similar manner. The building was repaired during the summer and fall of 1919. The illustration plainly shows at the spandrels, window sills and caps the distortion due to settlement.

The settlement was caused by the failure of the tops of the piles, wooden caps and sills, due to de-

cah. This portion of the foundation was above the present water level of the Chicago River. The piles were sufficient in number and size safely to support the loads without settlement.

The plans for reconstruction called for the removal of the old foundations, the wooden caps and sills and the tops of the piles to a point one foot below the water level, the construction of new concrete foundations, the underpinning of the walls, the raising of the settled parts to their original positions and the installation of a series of tie rods connecting the new foundation of the wall with a deadman placed about 50 feet north of the wall.

The new wall foundation of concrete is 7 ft. wide at the bottom, 2 ft. 6 in. wide at the top and 4 ft. 7 in. high. The concrete extended about 4 in. below the top of the piles and was reinforced by transverse bars at the bottom. New foundations for the columns were constructed in a similar manner. The deadman consisted of two 15 in. 55 lb. I-beams be-



THE CENTRAL WAREHOUSE, CHICAGO
Showing the method of raising and supporting the wall during the reconstruction of the foundation

tween which passed 1½ in. steel rods which extended into the concrete foundation and with large plate washer on each end. The deadman and anchor rods were encased in concrete.

In reconstructing the foundations of the south wall, the first step was to remove the wall and foundations below the basement doors and windows. The piles at these places were cut to the new elevation of one foot below the water level. On these piles a cribbing was built upon which jackscrews were placed.

In these door and window openings were put short heavy timbers which rested on the jackscrews. On these timbers were placed two 20 in. I-beams on both sides of the wall. Needles consisting of two 8 in. I-beams were passed through holes in the wall

and rested on the 20-in. I-beams. In the large doorway drums were put at each side of the arch. These drums transferred the load of the wall over the doors direct to the 20-in. I-beams, as shown in the illustration, and thus relieved the needles of that portion of the wall load. This reduced the crushing stress in the brick wall at the points of needle support.

By turning the jackscrews the wall was raised

to its original level position and supported on the piles below the door and window openings. The balance of the foundations was then removed, the piles cut off and new concrete foundation put in place under the walls. In these foundations were embedded the ends of the anchor rods, the other ends of which were attached to the deadman.

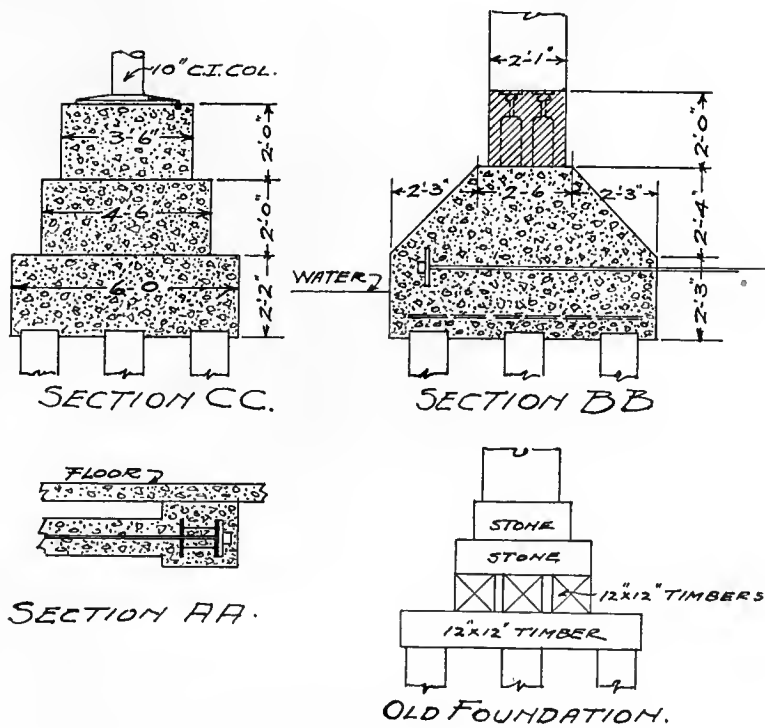

SECTIONS

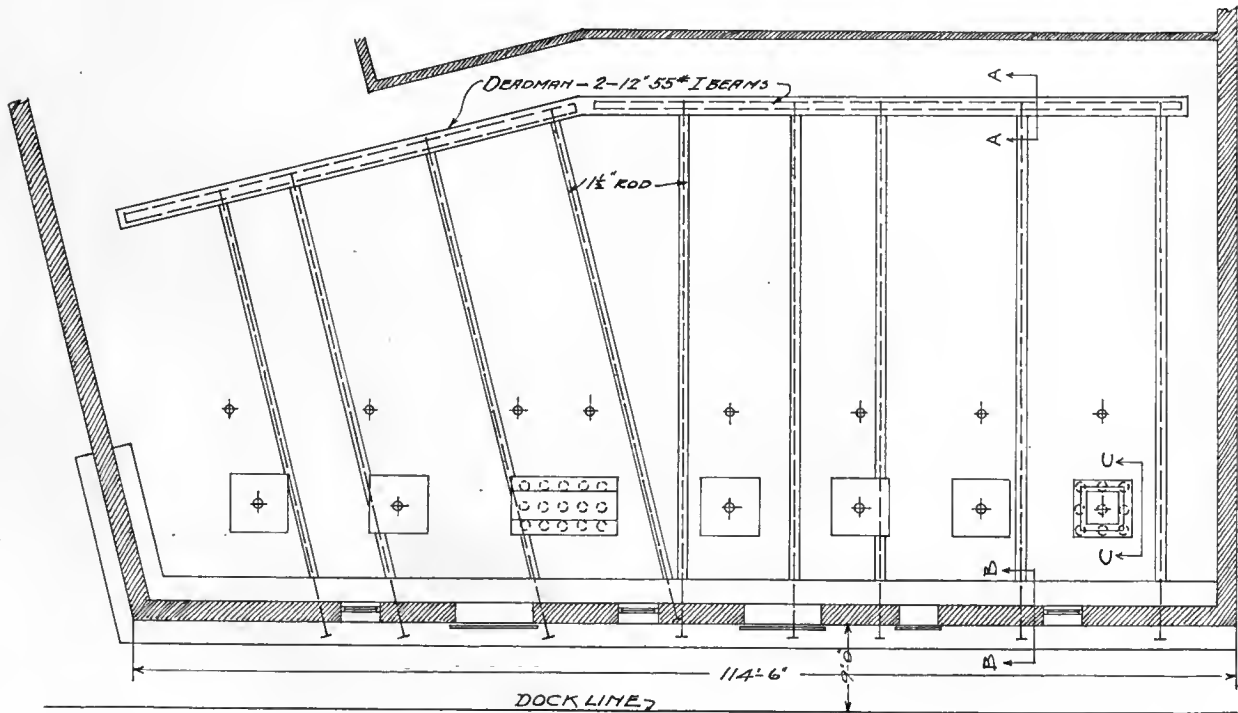

FOUNDATION PLAN

To the east and west of the central portion of the wall, the settlement was not so great. These portions of the wall and the return at the west end were supported on 8-in. I-beam needles which rested on sills, jackscrews and cribbing placed on both sides of the wall. The foundations were removed in short alternate sections about 6 ft. long, and the new foundations constructed. As soon as these sections of new foundation attained their strength, the wall load was transferred to them by two rows of direct drums as shown in Section BB. Then the alternate sections of the foundation were removed and rebuilt. Ultimately the entire wall was supported on the direct drums and so remained until there was no evidence of settlement in the new foundations. Then short, alternate sections of the wall were underpinned and the wall eventually rested directly on the new foundations. When the walk was raised, the cracks and displacements disappeared and it was in its original condition.

The settlement in the building was progressing in such a manner that its collapse could be foretold. To wreck and rebuild at that time would have been done at great expense and loss of revenue. By this method of reconstruction, the building was continuously occupied throughout the first to seventh floors inclusive. The only loss of revenue was that usually derived from the basement story. The work was done in record time as planned, and without hindrance or accident. Mr. Julius Floto, structural engineer, designed the anchorage and new foundations and the L. P. Friestedt Company executed the contract.

Note on Fire-Resisting Paints and Varnishes

By Henry A. Gardner†

AMMONIUM phosphate has been in common use as a component of fire retardant preparations for many years. When dissolved in water to make a solution of 10 per cent. to 12 per cent. strength and applied to cotton or like fabric, the cloth so treated is very resistant to fire. When ignited, the flame will go out almost immediately. The effect is probably due to the volatility of the salt, a fume being produced, which does not support combustion. Similarly, ammonium phosphate has been occasionally applied for many years as a constituent of fire retardant paints. For this purpose, the salt in finely divided condition is ground to paste form with linseed oil,* and the paste added to prepared paints in amounts usually from 10 per cent. to 20 per cent. of the pigment portion. In order to determine whether the fire retardant value of paints is

*It may also be applied in aqueous solution as a component of an emulsion liquid.
†Copyright, 1921, by H. A. Gardner.

really increased by the addition of such salts, the writer has just conducted some laboratory tests. Standardized Pamak Fire Retardant Paints were applied in two-coat work to white pine shingles. The same paints were then admixed with 10 per cent. of ammonium phosphate pigment-paste and applied to duplicate shingles. After drying for a week, the panels were submitted to a flame test. After being fully ignited, they were withdrawn from the flame. The flame on each set went out quite rapidly. While it was indicated that those paints containing ammonium phosphate showed slightly greater flame exit than the others, there was no very marked difference in the samples.

Since the standardized paints used in the above experiments are probably the most durable fire retardant paints produced so far, having shown but slight defects after weathering for four years, it would be inadvisable to recommend the addition of water soluble salts such as ammonium phosphate. This suggestion is made on account of the fact that such salts might during damp weather cause "washing" troubles.

For certain paints that are not subjected to exterior weather conditions, the use of ammonium phosphate might prove valuable. For instance, interior flat or gloss whites for slow-burning (wood) mill construction might be experimented with in this direction. There might also be a use for "phosphated" varnishes. As shown in Service Bulletin No. 3 of the National Varnish Manufacturers' Association, varnishes when applied to wood surfaces greatly reduce the fire hazard. This is due to the fact that the varnish film acts as a seal and prevents the combustible gases in the wood from escaping and becoming ignited. The writer has found that when ammonium phosphate is ground in varnish to the extent of 5 per cent., the color of the varnish is not materially altered, since the salt is very transparent in oil. Such varnishes become rather heavy in body and produce a somewhat rough appearing film. They might, however, find some special applications in the arts.

Another pigment that has given interesting results in fire resistant paints is zinc borate.* This product, when mixed with color pigments and ground in oil, produces a paint that has given excellent service on exterior exposure. The zinc borate pigment fuses to a somewhat glass-like film under the action of heat, and thus produces a seal that prevents the escape of combustible gases from the wood over which the paint is applied.

*Experiments conducted by Forest Products Laboratory, Madison, Wis.

A Louis XV Paneled Room

(Continued from page 586)

work oftentimes but the slightest indication of the interior treatment of the rooms. These were completed by the "menuisier" who was both carpenter and carver, either from the verbal instructions of the designer or following his own invention stimulated by the various engraved designs published for this purpose. This free method tended to develop the individuality and judgment of the worker and is responsible in a great measure for the piquancy and unique charm of the work.

From the standpoint of design alone a great deal can be learned from the study of such examples, where the essentials in the design are not obscured by elaborate detail. In this piece the delicate vigor of the work in the small panels, especially the pilaster strips, is worth careful examination. As in the best work of the period, harmony is obtained largely by the careful adjustment of curved lines of the same scale arranged in balanced series. Each design unit is thus composed of a number of opposed movements, no one overwhelming the other, but rather each converting its neighbor in turn, resulting in a whole static in effect but dynamic in quality. The subtlety and delicacy with which this idea is carried out forms the basis of excellence in all work of this period. The eye is led swiftly from point to point and never permitted to be bored, but on the other hand never permitted to be distressed by unmeaning violence.

Correspondence

The "Hawkeye State"

Editors: THE AMERICAN ARCHITECT:

I WAS interested and amused in perusing the article in your issue of the 13th inst. by Francis B. Ellis, on the "Hawkeye State." I, with a lot of other people from the Chicago Athletic Association, made the initial trip with this ship from Baltimore to Honolulu and returned to San Francisco and, having lived aboard for about forty days, became quite familiar with the physical conditions of the ship, and as I was delegated to write up the cruise for the "Cherry Circle," the Association's magazine, I have taken occasion to inform the public as to some of the real facts concerning the ship.

I have dealt with the subject more from an economic and practical viewpoint, but have really told only a small part of the story. The ventilating plant, for instance, is a complete failure. The day I visited the boiler room the temperature was 147 deg. and the men below decks had pulled off what might perhaps be termed a mutiny, breaking out all the portlights in order to get a little air. The ports, by the way, in the stateroom are 10½ in. in diameter and I understand they are to be increased to 18 in. There were no air chutes in the cabins and at Colon I succeeded in getting some galvanized iron, and

then mustered some of the passengers as helpers and we made four of these. Afterward the ship carpenters made quite a lot with some iron they found on board and at San Francisco they had the entire ship equipped with them.

Chicago.

EDWIN D. WEARY.

Editors' Note.—The foregoing is of interest as proving the contention of Mr. Ellis, that owing to the failure to consult with architects in the carrying forward of the various details of the Hawkeye State many unfortunate and easily preventable errors occurred.

Another Communication from An Old Subscriber

Editors: THE AMERICAN ARCHITECT:

I was greatly interested in the letter written to you by Mr. James M. Macqueen regarding the use THE AMERICAN ARCHITECT has been to him during the 35 years he has subscribed to it. I echo most heartily all he says but I can go further back than he can. I began my subscription January, 1879, so I have it in my files for 42 years. I have every plate of 1879-80-81 all bound just as they were issued. Since then I have of course learned to classify my plates so now I have a great collection.

I certainly would miss its regular arrival.

WILLIAM H. MERSEREAU.

Oakwood Heights, N. Y.

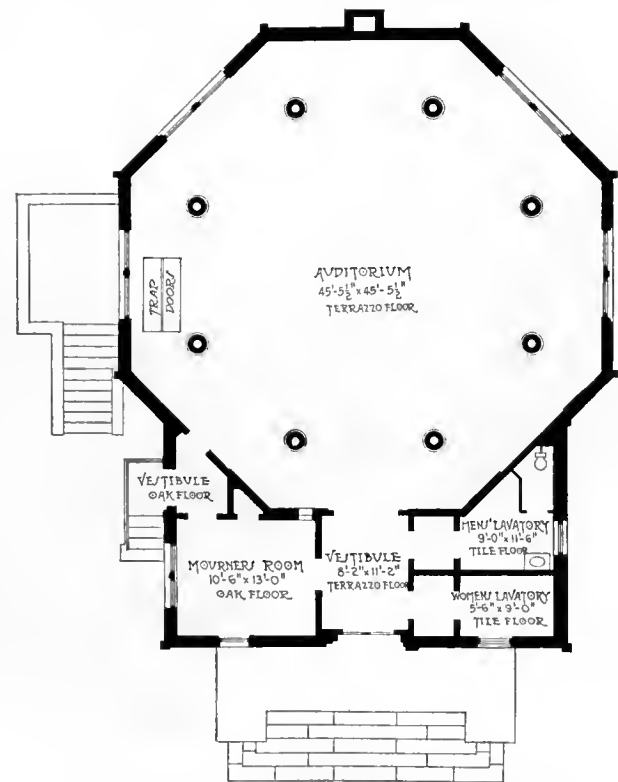

PLAN MENDLESON MEMORIAL CHAPEL

LEWIS COLT ALBRO, ARCHITECT

(For other illustrations see photo section)

THE AMERICAN ARCHITECT

Chicago's Field Museum

IT would cost \$1,640,000 to rehabilitate the old Field Museum building in Jackson Park and convert it into a permanent memorial for the people of Chicago, according to estimates placed in the hands of the South Park board recently by the Illinois chapter, American Institute of Architects, and the Illinois Society of Architects. The report was compiled by the Municipal Art and Town Planning Committee of the former organization.

A number of uses to which the historic old building might be put are suggested in the report by George W. Maher, chairman of the committee.

"The building as it stands today," said Mr. Maher, "is worth at least \$3,000,000. It would cost almost twice as much to construct it, at the current costs of labor and material. For slightly over a million and a half dollars, Chicago could have, in perpetuity, one of the most beautiful specimens of architecture in the world.

"It could be used as a great community recreational and art center, or as a branch of the Art Institute, which needs additional space. Here could be housed large architectural and sculptural models, such as the model of the Columbian exposition.

"There would be space for loan exhibits of Chicago artists, thus creating an opportunity for the sale of canvases and other works of art.

"The building would offer an appropriate place to start a school in industrial art, in which the association of commerce might be interested.

"Rehabilitated, the museum would become a great center for the liberal arts, a stimulus for creative art in all its branches, including music and the drama, and a factor in making Chicago the greatest art center in the world.

"It is universally agreed among architects, artists and critics that the building is unequalled as a pure example of classical architecture. It is the last remaining memorial of one of Chicago's greatest achievements, the Columbian exposition. Around it cluster memories dear to many thousands of people."

Growing Appreciation for Architecture

GEORGE HOWE, chairman of the joint exhibition board of the Real Estate and Building Exposition of Philadelphia, recently emphasized the growing appreciation of the true value and position of architecture as follows:

"The appreciation of the true value and position of architecture has made rapid strides in the immediate past, not only in the field of civic improvement, schools, hospitals, public buildings, but also among the more progressive industrial and commercial institutions.

"Philadelphia has from the beginning held an honorable place in this movement among the progressive

cities of our country. Not only has she provided many of our foremost architects (whom it would be invidious to name, lest one should be forgotten), but many of her ablest citizens have given unstintingly of their time and energy to civic improvement of every sort. The Parkway development alone, some drawings of which, in its completed state, may be seen on the walls of the architectural exhibition rooms, places Philadelphia among the leaders of progress in architecture.

"The Philadelphia Real Estate Board has, therefore, offered the architectural profession the opportunity of presenting before the large public which yearly attends the Real Estate and Building Exposition a group of architectural works of real educational value, comprising especially those elements in which our citizens are particularly interested: civic improvement and the modern dwelling."

Philadelphia's New Art Museum

PHILADELPHIA will soon erect an art museum in Fairmont Park. It will house not only the great accumulation of art treasures belonging to that City, but will also contain several bequests of great importance not yet on public view.

A correspondent to a Philadelphia daily paper makes the following good suggestions:

"We have heard a great deal about the new museum for Philadelphia's art treasures. The Park site is ideal. Let us hope it will rival New York's shrine and far surpass it in its construction. Is the public interested in the style of architecture for the erection of this building? There is a great deal of history centered around the settlement of William Penn, and the Colonial period is loved and revered by us all, although the condition of Independence Hall would not warrant a stranger forming that conclusion.

"Can we not have a reproduction that would stand for years to come on this Park site, that is altogether American? I am sure if such a structure were erected many bequests would be made for a final resting place for the old treasures of the Colonial period. If it is too late for the main building to be of this style, cannot an inclosure be made, reproducing, to commemorate that period, an historical building or interior?"

An Architect's Service Bureau

THE Indiana Limestone Quarrymen's Association has recently effected a reorganization, which will result among other improvements in a much better Architects' Service Bureau, and the publication of a really comprehensive series of service literature. This department will be conducted by Mr. H. S. Brightley, former secretary, who has become service engineer, and will devote his entire time to service research work of the organization. Mr. R. M. Richter, a former secretary of the Line-

THE AMERICAN ARCHITECT

stone Association, but for the past two years an executive of one of the limestone quarry operating companies, has returned to the Limestone Association as secretary and executive head of that organization.

Annual Dinner of New York Society of Architects

THE annual meeting and dinner of the New York Society of Architects was held at the Hotel Astor on the evening of May 17. The following officers were elected for the coming year:

President, James Riely Gordon; Vice-President, Adam E. Fischer; Second Vice-President, Edward E. Loth; Secretary, Frederick C. Zobel; Treasurer, Harry Holder; Financial Secretary, Walter H. Volckening.

Addresses were made by Robert D. Kohn, A. I. A.; by Rudolph P. Miller, Superintendent of the Manhattan Bureau of Buildings; by W. E. Walsh, Chairman of the Board of Standards and Appeals, and Mr. Tinken, of the Real Estate Record and Guide, who were guests of the Society.

Year Book, New York Society of Architects

THE tenth annual issue of the Year Book, edited and published under the direction of the New York Society of Architects, has been received. As usual, this is a compendium of architectural practice in general, and the State of New York in particular, and will serve the same useful purpose as have its predecessors.

The valuable feature in the present issue is the publication of the revised New York Building Laws, which in itself will make the book one of great value for reference for men practicing in this State. Copies may be obtained, and the price ascertained, by addressing Frederick C. Zobel, secretary, 35 West Thirty-ninth Street, New York.

American Students to Help France Rebuild

STUDENTS of architecture of proven ability from American colleges are to be sent to France in groups during the yearly vacation periods to aid the French people in the work of reconstruction.

As a beginning, a newly formed organization known as the American Students' Reconstruction Association, will send to France this Summer fifty or more students, who will live with the French people and be trained under accomplished French architects. The idea grew out of the sending to France last Summer of the Harvard Reconstruction Unit of twenty-five students who worked in the devastated districts.

It is expected that colleges and universities will defray part of the expenses of the venture, but a fund of \$250,000 is being raised.

Donn Barber of New York is President; Robert L. Buell, Harvard, '19, Secretary; Archibald Dudgeon, Treasurer; Ernest Angell, Vice-President; Otis P. Wood, Executive Secretary.

The organization announced that it has the endorsement of the architectural schools of Yale, Princeton, Cornell, Massachusetts Institute of Technology, Columbia and Pennsylvania.

Cannot Match Stone in Rheims Cathedral

A NEW problem has arisen in connection with the restoration of the Rheims Cathedral. The peculiar kind of stone used in the erection of certain portions of the building during the thirteenth century is showing signs of disintegration, probably due to the constant subjection to poison gas and shell fire during the war. It is feared that, for this reason, important sections of the walls may collapse.

It was generally believed that the whole cathedral had been built out of limestone taken from the Rheims Mountain, but it is now learned that the thirteenth century work was all done with a peculiar alluvial rock formation, brought from Fismes, which is known as "Roman block." When polished, this Roman block took on a rose gold surface in which small fossil formations could be detected.

Seven hundred winters, centuries of rain-storms, had left this stone practically undamaged, until the German war gas began its destructive work. Thus far, however, geologists have been unable to find more of this Roman block for the repairs which, if done with ordinary stone, would detract from the beauty of the structure.

To Enlarge University of Chicago

A N extensive and ambitious building program, involving the expenditure of \$15,000,000, to which John D. Rockefeller has contributed \$10,000,000, for the creation of a greater University of Chicago, is outlined by President Harry Pratt Judson in a booklet mailed to 10,000 graduates.

Perhaps the most imposing of the new units will be the \$1,500,000 university chapel.

Funds for its erection already are available, the money having been segregated from the \$10,000,000 gift of John D. Rockefeller. Tentative plans call for an edifice in Bedford stone and of Gothic architecture.

FEDERAL VIEWS TOWARD BUILDING TRADES

An Address by Hon. Herbert Hoover, Secretary of the Department of Commerce, to the Fifty-Fourth Annual Convention of the American Institute of Architects

"BY and large," said Mr. Hoover, "the services that the government can properly perform in remedy of this situation must be entirely indirect, for the government cannot enter into the fixing of prices or the determination of wages."

Among the obstacles blocking better conditions in building, Mr. Hoover enumerated "conspiracies to maintain prices and corrupt bargains with labor," excess profits taxes, the highest ranges of the income tax, the division of investment capital from building purposes, intermittencies of employment and the lack of a standardization of materials.

"The difficulties in our national housing," Mr. Hoover said, "have been ventilated time and again by the various national associations, by congressional investigation, State investigations, by statements of our public men—leaders of the industry. The appalling anomaly of millions of idle men, co-existent with suffering, as never before from under-housing, is obvious to everybody.

"The obstacles that lie in the path of the quick resumption of home building on the large scale needed have been repeatedly enumerated. Each enumerator puts a different weight of importance on these different obstacles, among which are the inequality in levels of economic readjustment—that is, in the high prices of building materials, of transportation, and of labor—the reduced income in many occupations, the conspiracies in restraint of trade, the restrictions on effort through the rules of organized labor, the strikes, the Federal taxation, the wastes in the industries, etc.

"IMMEDIATELY upon the inauguration and with the full approval of the President, the Department of Commerce undertook to study and organize such effort as the Federal government could properly give to the building situation.

"While any attempt at readjustments of prices and wages is absolutely a local question that must develop within each community, certain broader aspects of fundamental improvement in conditions could be wisely undertaken through Federal assistance and co-operation with the professional and trade organizations. These aspects more especially lie in direction of the elimination of economic and physical waste in the industry.

"I have held extensive conferences with many elements of the building industry, such as various branches of national organizations and individuals concerned in material, real estate, finance and labor, with a view to securing their co-operation. I was greatly pleased when some weeks ago I received a communication from the American Institute of Architects confirming the undertaking of the Department of Commerce of the building problem.

"IN order to secure the best advice I appointed a committee, consisting of Ira Woolson, consulting engineer of the National Board of Fire Underwriters, who has made a practical study of the building codes for years; Rudolph P. Miller, engineer in charge of building ordinances of New York and president of the Association of Building Superintendents of the United States; J. A. Newlin, of the University of Wisconsin, in charge of the Forestry Products Laboratory and a recognized authority on timber; J. R. Worcester, con-

sulting engineer of Boston, an expert on structural steel stresses and design; Prof. William K. Hatt, of Purdue University, who has had much experience with concrete structures; Ernest J. Russell, of St. Louis, an architect and a member of your institute, who has already contributed so much to the industry through his work with the Board of Jurisdictional Awards, and Edwin H. Brown, also a member of your institute, who has so greatly interested himself in the small home problem. By these arrangements your association, the engineering council, and other engineering bodies are represented.

"Reasoned opinions upon each question might be rendered by the various counselors that we set up. Again, these opinions or decisions might from time to time be promulgated as standards of practice endorsed by this department; eventually these opinions rendered may collectively form the basis of modern building codes and material standards and be guides for the reduction of waste and the improvement in building practice.

"I do not consider regulation by the government has any place in these matters. Voluntary action will be far more effective. In matters of readjustment of the economic levels, local community action will have a much larger value in securing a restoration of confidence in this industry, and aside from giving inspiration to such action, I do not consider the Federal government has any place.

"Such movements, through local conferences with the different branches of the construction industry—material, labor, contractors, together with bankers and other civic bodies representing the consumer—have already been started by the National Federation of Construction Industries. These efforts should be initiated and assisted in every town. They do not only raise moral standards but also secure helpful economic action by such community movements.

"Prompt and clear-sighted public service of this character may contribute materially to relieving the stagnation in the building trades and to the amelioration of suffering arising from the present condition. The recent declaration of the representatives of organized labor in these trades of a movement to establish joint adjustment boards in various communities is a step in the right direction.

"Your association could do much to bring all these elements together in constructive solution of many problems. I am, however, convinced that such efforts will be futile if attempted on other than a purely local basis. Attempts to settle wages or conditions of labor on a national basis tend in a direction disastrous alike to both labor and industry.

"THE conspiracies to maintain prices and corrupt bargains with labor can be eliminated by continuous vigorous action of the authorities. There will be no restoration of confidence in the industry until this is accomplished. A great majority of the manufacturing, distributing and assembling trades and workers are not in any manner participants in wrong-doing, and are indeed suffering from the actions of a small minority in the industry.

"There are some directions in which the Federal government can be of assistance in the problem. The

THE AMERICAN ARCHITECT

excess profits tax creates speculation and waste, blockades free dealing in property, and the higher ranges of the income tax drive capital out of building investment because of our national failure to secure income taxation of State, municipal, and national securities.

"There are certain diversions of investment capital from building loan and mortgage purposes, that I believe could be mitigated by amendment to the banking laws. The national banks should be given greater freedom to apply their savings accounts to mortgage purposes. The savings accounts of the country are its fixed capital, and should be applied to fixed investment, not to commercial purposes. There could also be a larger application of insurance money to mortgage purposes.

"The more particular direction in which it is the purpose of the Department of Commerce to exert itself in co-operation with the industry and its professional advisers is in the reduction of waste and the increase of stability in operations. It is only by steady and persistent drive to the increase of industrial efficiency in the national sense that we can hope for steady improvement in the comfort of our people.

"One phase that requires exhaustive study is the intermittent operation of the industry. In my view, it is the definite point where the greatest waste finds its roots and is the largest element of high costs affecting both labor and material. I believe that any study will show that the average employment of labor in these industries is not over 65 per cent. of their possible time. One of the reasons for the constant drive for higher hourly wages is to maintain an adequate annual income and to offset the loss due to intermittent occupation—and labor itself has contributed to intermittency by its rules.

"Our equipment capacity for production of building materials is probably 30 per cent. higher than is necessary for it, if we could secure nearly an average demand. For instance, our lumber mills have a capacity of above 50,000,000 to 60,000,000 board feet, yet the annual production is but from 32,000,000,000 to 40,000,000,000 board feet. The annual capacity of our cement mills is above 130,000,000 barrels, but the annual production runs from 70,000,000 to 100,000,000 barrels. The annual capacity of our brick plants is about 8,000,000,000 bricks; the annual production is from 3,500,000,000 to 7,000,000,000. There are periods when the production of many building materials is actually suspended, just as is labor suspended on construction work.

"If we examine the intermittencies we find that they fall into three general classes: First, seasonal and weather interruptions; second, strikes and jurisdictional quarrels; third, inability of transportation to meet the peak load.

"The seasonal and weather problems are no doubt to a great degree insurmountable, but there could be local community action in establishing a definite repair season out of conflict with the season of new buildings. The lost time from general strikes could be reduced by local adjustment boards and loyal adherence to their decisions. The jurisdictional strikes have no justification and I am informed that of the lost time due to all strikes in these trades over one-half arise from this quarter.

"THE committee on jurisdictional awards, in which your society participates, has performed good work. The abolition of such strifes lies entirely within the powers of organized labor. Settlement boards of their own, whose decisions would be binding, would be a contribution to labor's own income and employment. Labor could also greatly assist in lifting us from this blockade on building if it would set its face against any

restraint on effort that still survives in some trades. There would be less dispute over wages and larger employment if the rules could be revised by the local adjustment boards and community conferences.

"I am informed that from 10 to 20 per cent. of the cost of building lies in the lack of standards in a broad sense. We have, for instance, 260-odd building codes to which a large portion of the building of the country must conform. They vary flagrantly in floor loads, wall thickness, stress requirements, character of material to be employed; they hold back progress in methods of construction; they make impossible the standardization and simplification of certain materials which could be effected without affecting the attractiveness of design, of style, the arrangement of the interiors, or the usefulness of the buildings.

"We need a standardization and a simplification in many of the materials required. The dimensions of articles of constant use could be greatly simplified as to many construction materials, plumbing, hardware, etc., with great savings both in manufacture, distribution, and installation, and there need be no sacrifice of styles.

"There is another phase of this problem in which I believe the government could be of proper assistance. That is through the regular collection and prompt distribution of the current data of production, stocks, the general price levels of essential building materials, and the volume of activity in the industry. Such information would make for stability and elimination of waste.

"Many of the building material trade associations have endeavored to secure such data for their members. Often enough they have limited the distribution of these data to those who co-operated in securing it. Right here lies one of the causes and inspirations of certain types of 'open price associations' which so quickly degenerate into combinations in restraint of trade. If such fundamental data could be collected and promulgated to the entire public, it would abolish a justifiable reason for maintaining these associations; it would protect the small operator as well as the larger one and, what is of a great deal more importance, it would contribute stability to the industry.

"IF we take the single case of the lumber industry: Here the miller must in many branches prepare his material from eight to twelve months in advance of its consumption; he must take the risk of fluctuating demands both in varieties and quantity. It is of primary importance—if this industry is to reach a condition of stability—that every miller in the United States should know the current stocks of the principal varieties of his competitors. It is of primary importance that the whole public should know these stocks and the actual selling price of these materials at the point of manufacture.

"If such information were spread generally, the public, by adding the freight rates and a reasonable handling charge, can quickly judge the righteousness of a quoted price and can attain some measure of protection as to price. The tendency of such information is to prevent overexpansion of the industry—a distinct contribution towards the elimination of intermittent operations.

"The Department of Commerce, under the census law, is called upon to provide such data from time to time. The intervals have been too far apart and publication so delayed as to give the data only a historical value. I have undertaken to organize this matter and am asking for co-operation of the industries in making the service more effective.

"The efforts of conventions and associations such

as yours, the many local efforts at readjustment, such efforts as I have outlined, the activities which the Department of Commerce is undertaking to secure the co-operative effort of the entire industry in the solution of questions of building codes, standardization of materials and specifications and simplifications of articles, as well as in the recruiting and distribution of data with regard to production and activity are, in fact, the fundamentals upon which the correction of this situation must ultimately rest. There is no ready formula or panacea for our troubles. We have got to

get to the bottom of this whole matter to develop the efficiency of the industry, secure the elimination of its wastes and, above all, we have got to work harder.

"This is not a program of government domination and interference in business. It is a program of service that can be rendered by co-operation with the industry. The end that we seek is the end of all government, and that is to improve the daily living of all our people. It is the desire of the Department to co-operate with you to solve these problems."

THE BUILDING SITUATION in the MIDDLE WEST

(Special Correspondence to THE AMERICAN ARCHITECT)

CHICAGO—Uncertainty continues to characterize the building situation in Chicago. The uncertainty, however, is of a more hopeful nature than that which has made the early spring season such a matter of guesswork with everybody connected with the building industry. The chief complication at present observable is the lack of certainty regarding the end of the building tie-up which is now in effect as a result of a divergence between associated contractors and union labor. The issue came to a sharp break on May 1 when the contractors decided to suspend operations on all buildings in their charge unless the union builders accepted a wage cut amounting to about 25 cents per hour. The unions flatly rejected the offer and the lockout ensued.

Since May 1 building has been at a virtual standstill, and until the opposing sides to the controversy adjust their differences there will be no building of importance here. Both sides are now hopeful that some ground of mutual concession will be found upon which a new agreement may be based, although their public utterances indicate both sides as being firm and inexorable. As this is written—around the middle of the month—rumors are in circulation to the effect that a truce will be patched up, but architects are rather fearful that any further delay will have the effect of nullifying many important building plans as far as 1921 is concerned.

While the task of the prophet is both uncertain and thankless, it may be said to appear to an interested observer that labor concessions will have to be made before building can proceed. The employers undoubtedly occupy the stronger strategic position, because the public demand for building has suddenly subsided and the shoe is on an entirely different foot than that which wore it during the high pressure days following the armistice. Apparently the public has lost its fervor for high priced buildings and lots of them. The average man who heretofore contemplated building is now willing to abide the process of events, convinced in

his own mind that the man who waits will pay less for his construction than the man who builds now.

Contractors talk of an open shop movement, but unionism is so strongly entrenched in Chicago's industrial life that threats of the open shop are not likely to see fruition. A compromise on the wage scale is more likely to provide the key that will end the deadlock. Union builders in the skilled lines formerly received \$1.20 per hour and the contractors want to reduce that sum to \$1 an hour with a reduction of from \$1 to 70 cents per hour for unskilled building labor. Increased individual efficiency of the building labor may be held to justify a slightly higher wage than the one now proposed by the contractors, and a settlement on the basis of \$1.10 or \$1.05 an hour is not unexpected.

The Chicago public has had its enthusiasm for building considerably dampened, however, by other things than the dispute between builders and contractors.

For one thing the anti-profiteering legislation aimed at Chicago apartment landlords is in danger of proving a considerable detriment as far as further building of apartments is concerned. Prospective builders foreseeing favoritism to tenants in such legislation are refraining from entering a field where obloquy and possible litigation await them. There has been a substantial decline of building permits as far as apartment structures are concerned since the so-called Kessinger bills in the Illinois legislature have been in pendency.

Another thing that is serving to discourage the building of apartments is a growing feeling that Chicago is not particularly short of residential structures after all. The realization is dawning slowly, but is dawning, nevertheless.

Following the war, and particularly during the flush post-armistice period, the highly paid working classes worked up a very acute class consciousness and found themselves aspiring to residence upon plutocratic thoroughfares. The result was that apartments of the better grades and in the better localities could not be erected rapidly enough to meet the demand. With the deflation period has come a consequent deflation of the workingman's purse and he has found it incumbent to return to his less expensive habitat. The logical outcome of this

THE AMERICAN ARCHITECT

deflation movement has been that the less favored apartments, vacant during the flush days, are now filling up again, while the rent sign is beginning to bloom in the high priced neighborhoods. Real estate agents say that there are many hundreds of high priced apartments now vacant, and a cursory survey of the residential districts gives corroboration to this view.

A deterrent of more pronounced character, however, is found in the revelations which have come as a result of the joint legislative probe into Chicago building conditions. The Dailey probe committee has been actively at work in Chicago for several weeks, and the papers have been fairly filled with sensational reports of graft and "shake-down" on important Chicago structures. The assertion has frequently been made during the probe that every important building constructed in the business district in the last five years has paid tribute to an unholy avarice on the part of labor leaders and union agents.

Judge Trude, formerly on a Superior Court bench in Chicago, but now engaged in law practice in Chicago, told the investigating committee that he knew of \$45,000 paid to union agents by the builders of the State-Lake theatre and office building finished a year ago. The tribute was paid to avoid delay by means of the strike, and more than one set of officials are alleged to have shared in the profits of the "shake-down." Beginning with excavation and continuing through various phases of construction it was found necessary to oil the gears of the local union system, and that in a very substantial manner. The payments were made for "advertising," "fines" and other meaningless synonyms for plain and simple graft.

Indictments have resulted from these revelations and other indictments are said to be on the fire.

The investigation while revealing a sad state of affairs as far as the unions have been concerned has not been exclusively focused on the poor workingman. Building supply dealers and manufacturers of building supplies have also found themselves very conspicuously and unhappily in the limelight.

Illicit combinations between manufacturers and contractors and between contractors and unions have been prominently aired in the public prints with the very logical result that the Chicago mind is becoming imbued with the idea that anybody who builds now on an important scale must be prepared to pay tribute to everybody with whom he deals in the construction of the building. Perhaps this statement should be revised, for there has been no intimation of culpability as far as the architects of the city have been concerned.

It can be seen that reasons are multiplying against building, while the favoring circumstances have not increased accordingly. Architects hold the opinion that unless speed is manifested, the big

building program which Chicago has been boasting about in prospect will not get under way this year.

The effect of the building tie-up and other adverse conditions on the lumber and supplies' trade has been unfavorable, but these lines were spared the shock of depression mainly because they were sufficiently depressed prior to recent setbacks. There was very little call for building materials under the apathetic condition of building, and now that the building has been reduced to the irreducible minimum, lumber and other materials are hardly any worse off than before.

Prices of lumber and materials have remained practically unchanged mainly because nobody cared to ask what the prices are. When building is resumed, renewed demand will force a readjustment of prices, but until that takes place prices being quoted are merely nominal and mean nothing as to the real value of the merchandise.

BUILDING CONDITIONS on the PACIFIC COAST

(Special Correspondence to THE AMERICAN ARCHITECT)

SEATTLE.—It is possible now from the basis of price recessions, decline in labor overhead, greater satisfaction as to the base on steel and lumber and inclination of investors, to report a substantial improvement in the summer outlook for construction on the Pacific Coast. While lumber has remained steady it is apparent to architects, contractors and investors that no farther recessions in lumber should be contemplated in making up the building budget for the year or in estimating costs.

There has been a more noticeable movement in May in sheets, nails and pipe, both for the city and country work, than for any previous month of the year. Probably the outstanding feature of the Northern portion of the Pacific Coast markets is the decline in cement, which was not made by the manufacturers but in gross margin by the dealers of 25 cents per barrel. This move was made possible by dealers who report that their labor costs have declined, and that it would not be just to employes to be asked to stand a cut in common labor from the peak of \$5.25 to \$3.60 per day, the present scale by jobbers of building materials and hold profit steady. Lime has declined 50 cents per barrel at the plants and plaster wall board has fallen to 35c. per square yard. Common brick is steady, but Idaho fire brick manufacturers have queried coast jobbers on the question as to how much they should reduce prices to conform to the needs of the hour. Metal lath is down to 37 cents.

Wholesalers and jobbers in construction materials outside of lumber point out that there is no reason for withholding farther any building commitments that might be under contemplation, or for a jobber who has reduced his stocks to keep off the market.

THE AMERICAN ARCHITECT

The fear of advancing costs prevails no longer. All large operators are easy in their mind as to futures. Investors are giving forth a much more cheerful note, inspired in large measure by the distant but ever-near German settlement with the Allies. It has been the feeling all along in lumber circles of the West Coast that a settlement of this question would restore fiscal confidence, ease loans, reduce interest rates and loosen money, and many symptoms of the fundamental soundness of this position are coming forth.

Cement seems to be undisturbed. Although there have been two spring reductions, both have come from exterior sources in which the manufacturers took no part, first in the decline in bags and second through reduced gross margins by dealers.

The fir lumber market has held stationary in the face of a light spring railroad volume. The movement to the Atlantic seaboard of fir lumber has been very heavy and is increasing as the intercoastal water rates soften. More was moved on the \$20

rate to New York than on the \$22.50 rate and there has been an increase in the volume since rates declined to \$18 and in a much heavier proportion.

The feeling in fir lumber circles is that the season is now too far advanced for heavy spring movement, but with easier money conditions a strong August enquiry and sale is confidently looked for. This is based on reports from eastern buyers, where yard building stocks have been reduced to the minimum of the past three years. The car supply is now so ample that fir lumber could be loaded in the West Coast territory in August and delivered in the eastern building territory in time for structural enclosure before cold weather.

There are heavy accumulations of common dimension and large timbers due to the lack of railroad buying, and this fact is keeping the market from a reaction. Finishing sizes are sufficiently scarce to require much shopping by wholesalers among the mills in making up carloads for eastern buyers.



THE WHITE HOUSE, WASHINGTON, D. C.

frontis piece & No. 2369.

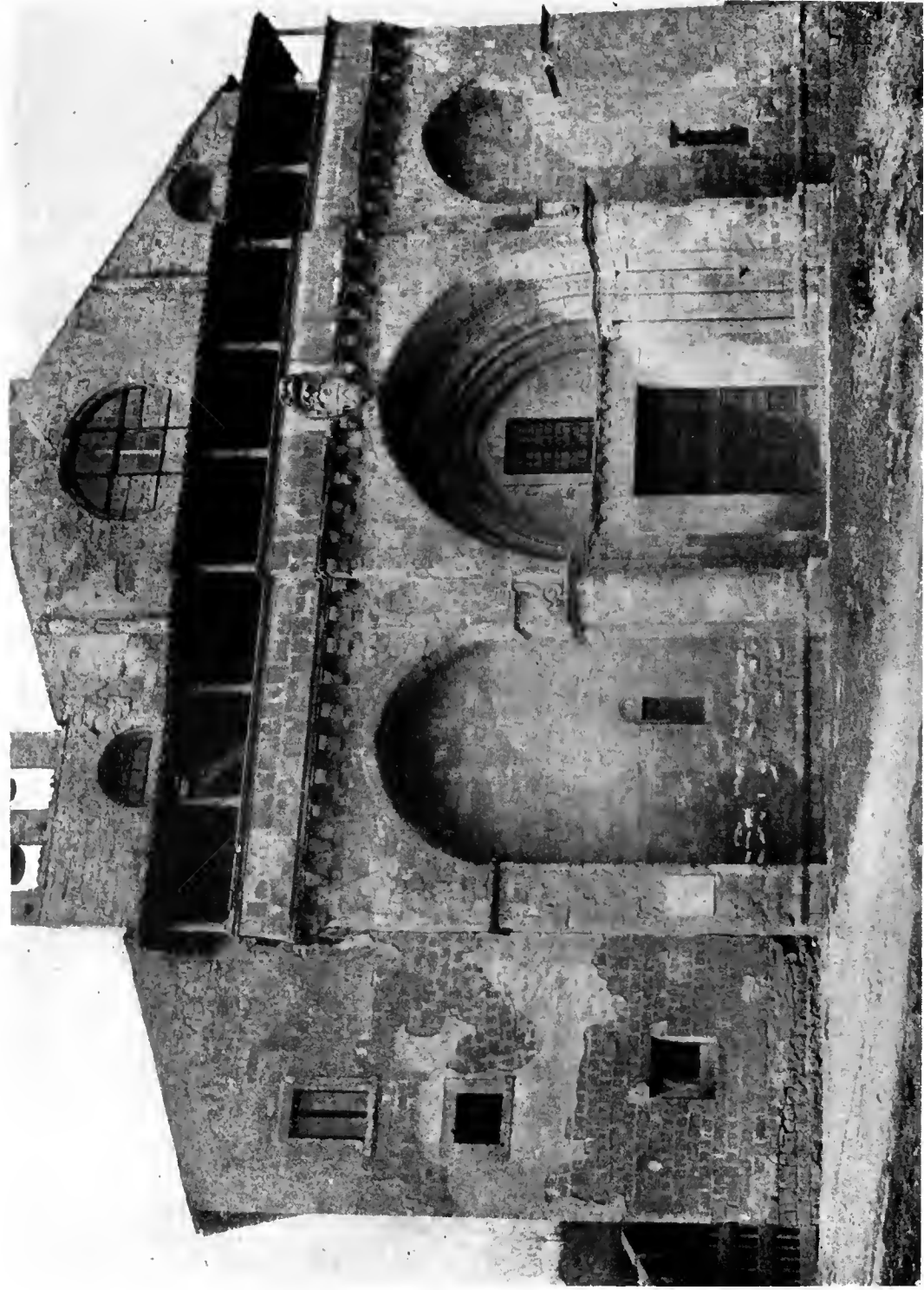

DETAIL OF A SPANISH CHURCH, CIRCA XV-XVI CENTURY

THE AMERICAN ARCHITECT

VOL. CXIX

WEDNESDAY, JUNE 8, 1921

NUMBER 2369

HIGH BUILDINGS on NARROW STREETS

Being Extracts from a Paper Delivered Before the Fifty-Fourth Annual Convention of the American Institute of Architects

By HARVEY W. CORBETT, F.A.I.A.

WHEN I came into the building this morning I was met in the corridor by a delegate who said: "I understand that you are going to tell us how to plan high buildings. Now, that really is not necessary. We know how to plan high buildings. I wish you would tell us how to get high buildings to plan." (Laughter) I do not propose to tell you how to plan buildings, and I do not see how I can tell you how to get high buildings to plan because all those that I know about I am planning myself. (Laughter)

I was somewhat worried when I got the title of this discussion, "Planning High Buildings for Narrow Streets." I was afraid it might be turned into the form of a question, "What shall be done to an architect who plans high buildings on narrow streets?" (Laughter) I was afraid I might be sentenced to a life of hard labor in the lower story of one of these high buildings, where sunshine never by any chance penetrates.

Architecture, we are told, is an expression always of the people of any given period. I sometime wonder if our present New York architecture is an expression of the New York people. Certainly, as you come up the Bay, especially as you come in a steamer from the other side, and get your first view of New York, it is an impressive and imposing sight.

I think that probably the American people are impressive and imposing people.

But as you get farther up the river and get a side view of New York, there seems to be a certain amount of "jazz" in outline, and I am afraid that

if you get a side view of the New York people you find the same amount of "jazz." (Laughter)

Perhaps the most characteristic feature of the American people is given in that old-fashioned expression of "putting up a bold front." We, as architects, do a great deal of that. We put up bold fronts. We do not put up sides and backs and tops to go along with those bold fronts. (Applause and laughter)

A foreign architect whom I asked once to give me an opinion of his visit to New York as concisely as he could, said, "Streets without end. Fronts without sides. Signs. Penthouses and tanks." (Laughter)

Now, carrying this idea of architecture as an expression of a people further, I think

that our present architecture is a very clear-cut expression of our present democracy. It is a democracy in which there is so much freedom that every man is free to do exactly as he pleases, without the slightest regard for his neighbors; and the conditions under that form of democracy have been carried to such an extent in New York City that we have been



FISK BUILDING, BROADWAY AND FIFTY-SEVENTH STREET, NEW YORK

THE AMERICAN ARCHITECT

obliged to create a law making it impossible for that situation to continue.

Speaking of building laws, I want to discuss particularly examples of the changes which have occurred, due to the new law in New York; but, before discussing this law, I would like to call your attention to the law in the city of London, with which I have had some contact and conflict in the

SETBACK PRINCIPLE.

Typical example in a 1½ times district, for streets 50' to 100' wide.

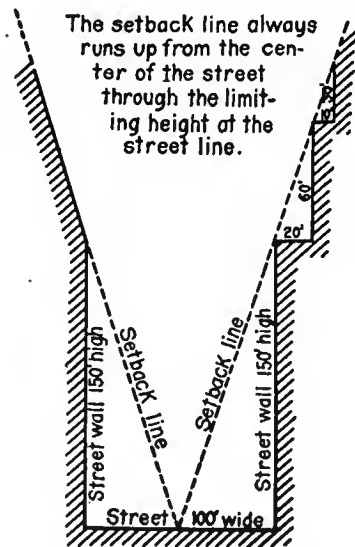

last few years. There the law was not brought about in such a systematic and thoroughly studied manner as the New York law. Queen Victoria happened to look out of her bedroom window one morning and across the trees of St. James Park she saw something architecturally extremely ugly which was rising above these trees. She made an investigation at once, called in her ministers, and had a law passed limiting all future buildings in London to eighty feet in height to the cornice line, with two stories and a roof, and a sort of a mansard. The particular building which inspired this law still exists. It has an excessive height of twelve stories. Just imagine—twelve entire stories; and it is exceedingly ugly. This is the only example that I know where humanity has directly benefited through a piece of perfectly ugly architecture. (Laughter)

I want to read you the general principles on which this law which we have discussed, in New York, is founded. "The law was framed to stabilize and confirm property values, to relieve the rapidly increasing congestion in the streets and in the transit lines, and provide for a reasonable amount of light

and air in the buildings and in the streets, and in general to make the business of the city more efficient and the life of the city more healthful, convenient and agreeable."

That law has been in operation since July 27, 1915, and judging from what it proposes to do, I do not want you all immediately to move to New York on the theory that the millennium has arrived, because, while the law is in operation, it has not quite resulted in making the city very much more convenient, beautiful or agreeable; but it has done, or is doing a very great work.

I am going to confine my effort principally to that part of the law which affects the height of buildings, although I must explain to you that this law is tied up very definitely with a zoning system as to the use to which buildings may be put, and that the height law varies in different parts of the city. The law, in principle, is simply this, that on any given street the building line on a principal front may go to a height which is a factor of the width of the street. Then a line drawn from the middle of the street through that corner goes on indefinitely, and a building continuing above that height must remain back of that line.

In London, for instance, this height would be



FIG. 2. GOTHAM NATIONAL BANK BUILDING, COLUMBUS CIRCLE, NEW YORK

HEIGHT LIMITS - 1/2 TIMES DISTRICTS

Same principles apply in each of the other districts. Set backs may be at each story or several stories at once or in the form of a mansard.

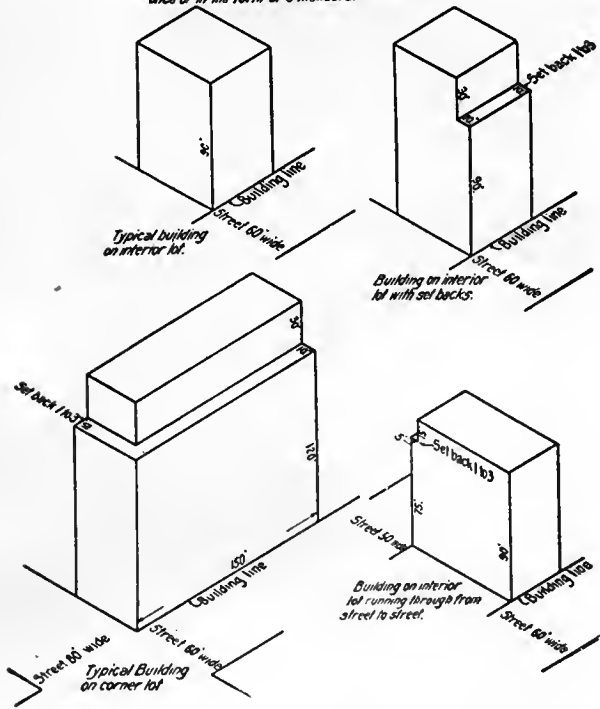

-TOWERS-

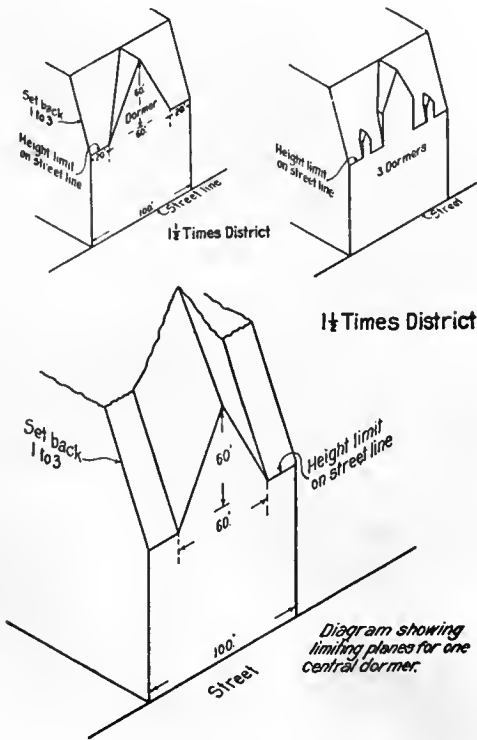
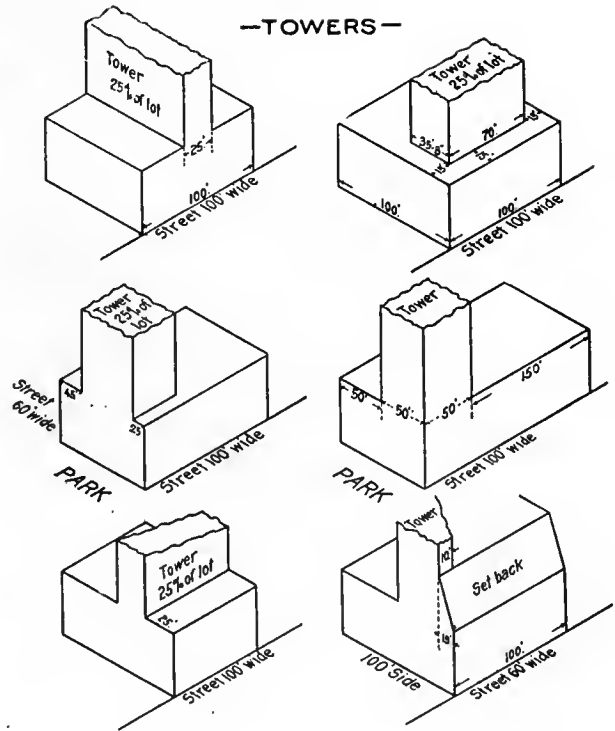

CORNER BUILDINGS
One and One-half Times District

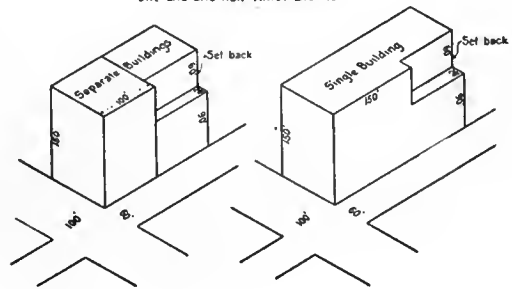

FIG. 1
NEW YORK CITY ZONE LAW DIAGRAMS



FIG. 3. LIGGETT BUILDING, FORTY-SECOND STREET, NEW YORK

limited to a definite height of eighty feet, irrespective of the width of the street. In Paris, and other European cities the height varies with the width of the street. In New York the city is zoned, first for a maximum of two and a half times the width of the street, then in other sections twice the width of the street, and one and a half times, and finally once the width of the street. The reason for this was that if we had made, with the conditions in New York as they are, a law which was uniform for the city, it would have worked a tremendous hardship on property owners in those sections of the city such as lower Manhattan, where the existing types of buildings had developed a certain property value; and it would have made it impossible for future property returns to be the same on that value unless the law allowed a condition practically similar to that already existing.

The law, as you see, operates depending on the factor of the street. In some cases you will be in the one and a half district, on a street 100 feet wide, and that allows you 100 feet direct height, then, set back in proportion to these relations, you could carry the building back in the form of a mansard without any offset at all. That gives you a condition upon the corner something like (Fig. 1), where it drops off at a given point at the center. In a street 60 feet wide, if the height law permitted, we would have this condition (indicating). These set-backs are not necessary unless a man wishes to go above the restricted height.



FIG. 5. UPPER STORIES OF FISK BUILDING

Then, in addition to this set-back law, you are allowed a certain proportion of dormer, so called; that is, in a 100 foot building, 60 per cent of it can go up in a dormer at 45 degrees, and then that dormer goes back on the same angle. That forms a sort of an envelope of a rather irregular shape, inside of which the building must remain.

This need not all be taken in one dormer, but it can be divided up in a series of dormers of various sizes, provided the total width of the dormers does



FIG. 4. REAR VIEW OF FISK BUILDING, BROADWAY AND 57th STREET, NEW YORK

not exceed 60 per cent of the width of the building.

New York has today so many towers and tower buildings, many of them of such interesting silhouette and composition, architecturally speaking, that the drafters of this law concluded that it would be a mistake to prohibit towers, and to prohibit buildings which went to unusual heights. With New York and its skyline as it is, certainly additional towers will not detract from the present outline; so they have this additional clause which permits, on any given piece of property, a tower of indefinite height over 25 per cent of the lot. That means that the tower over 25 per cent of the lot may rise from the center of the lot or from one end of a building; or it may take a different shape. The only limits placed on the height of that tower would be structural limits, and the limits of course that the owner himself would impose through the use of elevators.

Fig. 2 is one of the examples that has just been completed in New York, the Gotham Bank Building, at 58th Street near Columbus Circle. There we see the use that is made of the dormer idea. You see the whole face of this building is turned into a dormer which lifts up, showing on the face, as is permitted, 60 per cent. Then the set-back occurs, with some degree of variation. The side-walls, of course, remain straight, and each course remains straight;

but it seems that the fact that it is necessary to design these set-backs has made the architects look at these buildings from every angle. While this building is an example of carrying this to the extreme of the altitude permitted by the law, yet I believe that it illustrates very successfully the improvement which this law has made in the contour of buildings as compared to the old idea of the box, of which we have so many examples in New York.

Fig. 3 was the best view that I could get of the Liggett Building on 42nd street, which shows here the set-back. They have taken advantage of the dormer idea and inserted a sort of a pier, ending in a break and set-back, then the next recess above that, obtaining a comparison in street silhouette with the neighboring building which goes right up, as the construction was under the old law, to the hard line of cornice.

Fig. 4 is the rear of the Fisk Building. That, of course, will be in all probability hidden by buildings; but we get an illustration of the set-backs here, as they are affected by the street line. In this particular building the architects have made a very interesting silhouette, not going exactly to the maximum that the law would permit, but taking advantage of certain structural conditions and making an outline that is interesting and successful. You get



FIG. 6. HECKSCHER BUILDING, FIFTH AVENUE AND 57th STREET, NEW YORK



FIG. 7. ANOTHER VIEW OF THE HECKSCHER BUILDING, FIFTH AVENUE AND 57th STREET, NEW YORK

THE AMERICAN ARCHITECT

the mass of the main front of the building, and it gives, I think, a very comprehensive idea of what this new law does for the silhouettes of high buildings. It is unfortunate, I think, of course, that these buildings could not be finished all the way around with the same idea; but in this particular case it has certainly been beautifully handled on three sides, and that is two sides more than it is generally handled on.



FIG. 8. NATIONAL ASSOCIATION BUILDING, WEST FORTY-THIRD STREET, NEW YORK

Fig. 5 shows the upper stories of the Fisk Building. The view down 59th street, or from the park, is very imposing, especially the silhouette of these masses and the relations of the corner masses filling in the contour.

Fig. 6 is the Heckscher Building, at 57th Street and Fifth avenue. There, again, we are getting a rear view, in which a certain amount of effort has been made to ornament the back. But you see they have gone clear back to a point which will take the line from the street center, which is allowed.

Fig. 7 is a view of the other side of that same building, and it is a very pleasing contour, especially of the roof and top. Now, that properly amounts to a tower. It is a skyscraper of the old idea, but more interesting certainly than the old buildings you see in the examples further down the street.

Fig. 8 illustrates one of the views very close to a building, showing again the set-backs, and at the top, the projecting dormer, which gives an added variety to the contour across the building. I think the han-

dling of this in very delicate detail and without elaborate cornices is an excellent example of the practical solution of a commercial building, at least so far as its street front goes. There is not any pretense about it, and yet it does have a charm which the old type lacks entirely.

Fig. 9 is an example of two buildings on the same street, both built within the law, but illustrating a peculiar thing in the law, which is this. This building has opposite to it a 20-story building, as you see. The effect on that building is to permit it to go higher than its neighbors. The idea was that where a high building exists in the city, it seemed only fair that the buildings in the immediate neighborhood could also be high, although they could not possibly be permitted to go above the prevailing law; yet there is a certain percentage of amount authorized, at least one or two stories, that the building gains because



FIG. 9. REAR VIEW OF WURLITZER AND BUSH BUILDINGS, FORTY-SECOND STREET, NEW YORK

of the high building opposite to it, which others did not get. This would tend, as you can see, to the final development in the buildings of the city up to the maximum height, in having the building line sort of swing up to the tall buildings and down again.

This view of the Wurlitzer Building, Fig. 10,

(Continued on page 617)

Beaux-Arts Institute of Design

DIRECTOR OF THE INSTITUTE, LLOYD WARREN

ARCHITECTURE, RAYMOND M. HOOD
SCULPTURE, JOHN GREGORY

INTERIOR DECORATION, ERNEST F. TYLER
MURAL PAINTING, ERNEST C. PEIXOTTO

Official Notification of Awards—Judgment of
April 19, 1921

SECOND PRELIMINARY COMPETITION
FOR THE FOURTEENTH PARIS PRIZE
of the
SOCIETY OF BEAUX-ARTS ARCHITECTS
PROGRAM

The Annual Committee on the Paris Prize Proposes as subject of this Competition:

“A STADIUM FOR THE OLYMPIC GAMES”

The Commission in charge of the next Olympic Games has secured, about a mile from the outskirts of a large city, and connected with it by large boulevards and rapid transit lines, a large tract of ground upon which it proposes to erect the Stadium and all the dependencies necessary to insure the complete success of the games.

The problem is the treatment of this tract which includes:—

I. THE STADIUM:

This should be sufficiently large to seat about 100,000 people and should completely or partially enclose a quarter-mile running track within which are to be placed the football field and space for the various field events, including an open air pool 100 feet long for swimming and diving contests. There should be a monumental entrance to the field for the reception and the parade of the contestants from the different countries; this may also serve for the finish of the Marathon race. It is of the greatest importance to provide for the handling of the spectators through ticket entrances to various parts of the structure, and for their quick egress by means of stairs, ramps or otherwise.

2. TRAINING QUARTERS FOR THE ATHLETES:
These may be located in places remote from the Stadium proper if desired, to insure quiet and isolation, and should consist of a dozen or more buildings—one for each country represented—providing living quarters, locker rooms, showers and training rooms.

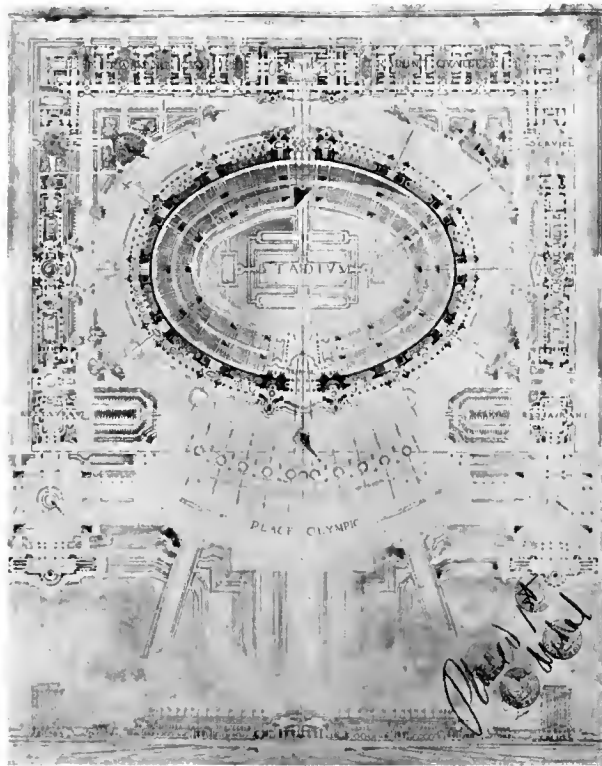

PLACED FIRST—SECOND MEDAL

L. MORGAN

ATELIER HIRON

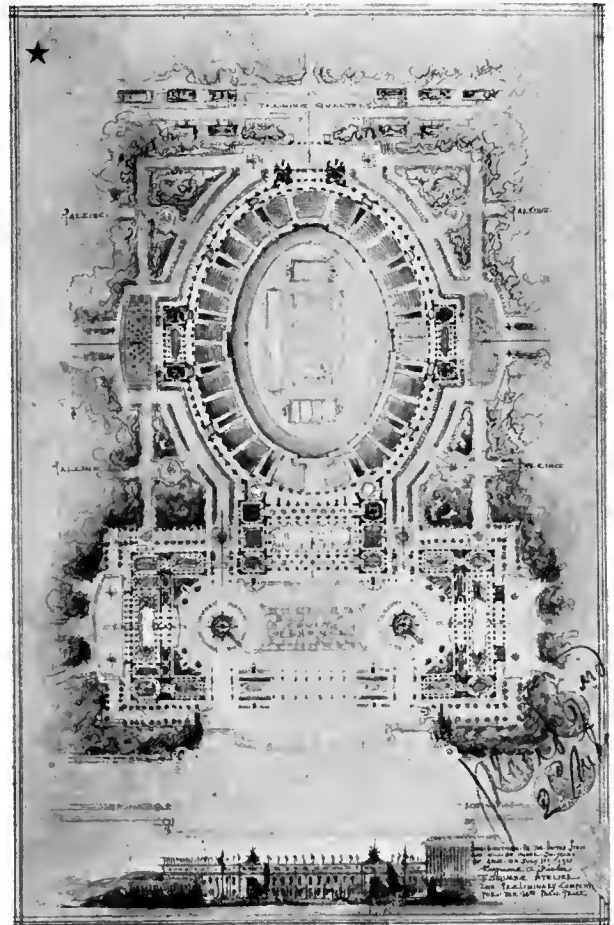

PLACED SECOND—SECOND MEDAL

R. A. FISHER

“T” SQUARE CLUB

3. HOTEL ACCOMMODATION:

A hotel or hotels to accommodate about 5,000 people, so placed as to be convenient to the Stadium yet, if possible, out of the general path of circulation of the great crowds from the city. They should comprise all the necessary features of the modern hotel.

4. RESTAURANTS:

These are to provide for those who attend from the city or outlying districts.

5. PARKING SPACE FOR AUTOMOBILES:

This should be placed near the entrance to the grounds from the city and should have several entrances and exits.

GENERAL:

Careful study should be given to the circulation and the handling of the spectators to insure quick and easy ingress

THE AMERICAN ARCHITECT

and egress and to avoid, as far as possible, interference between those coming from the city and those at the hotels within the Stadium grounds. Free entrance is permitted to the grounds, admission is charged only to the Stadium itself.

The size of the plot is 2,000 feet by 1,500 feet and is approximately level.

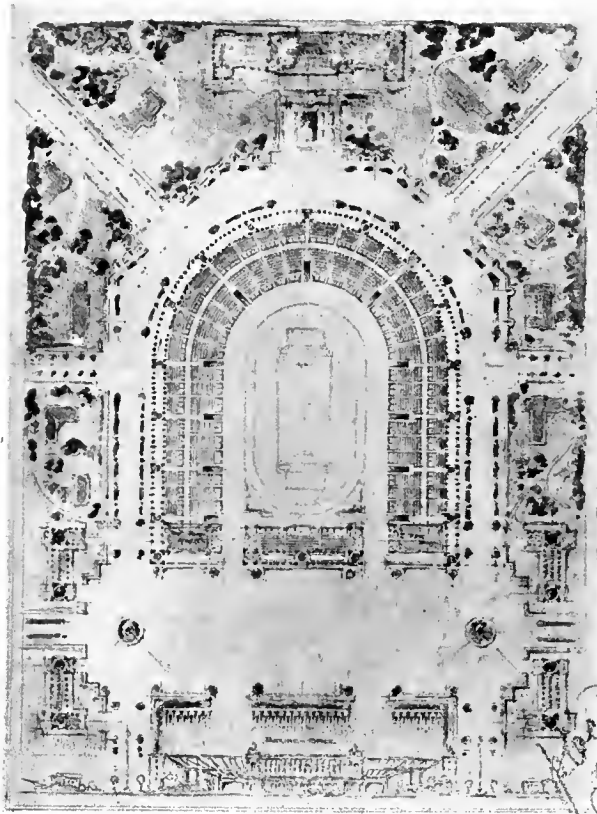

PLACED THIRD—SECOND MEDAL

A. WESTOVER, JR.

"T" SQUARE CLUB

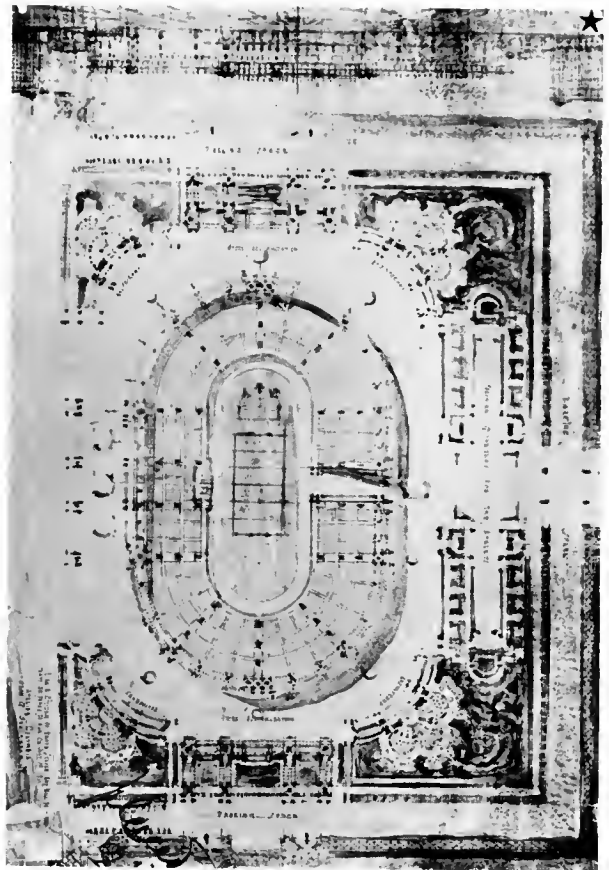

PLACED FOURTH—SECOND MEDAL

J. G. SCHUHMAN, JR.

COLUMBIA UNIVERSITY

PLACED THIRD—(2nd Medal); A. Westover, Jr., "T" Square Club, Phila.

PLACED FOURTH—(2nd Medal); J. G. Schuhmann, Jr., Columbia University, N. Y. C.

PLACED FIFTH—(2nd Medal); H. S. Atkinson, "T" Square Club, Phila.

PLACED SIXTH—FIRST ALTERNATE—(3rd Medal); W. F. McCaughey, Jr., Chicago School of Architecture, Chicago.

PLACED SEVENTH—SECOND ALTERNATE—(3rd Medal); L. Fentnor, Atelier Wynkoop, N. Y. C.

MENTION—R. H. Segal, 56 W. 46th St., N. Y. C.; S. J. Laschenski, O. M. Olsen and A. C. Bieler, University of Pennsylvania, Phila.

Jury of Award—L. Warren, B. W. Morris, R. M. Hood, J. W. Cross, W. S. Wagner, J. M. Howells, J. G. Rogers and H. O. Milliken—Chairman.

Number of Drawings Submitted:—25.

AWARDS:

PLACED FIRST—(2nd Medal); L. Morgan, Atelier Hiron, N. Y. C.

PLACED SECOND—(2nd Medal); R. A. Fisher, "T" Square Club, Phila.

THE AMERICAN ARCHITECT

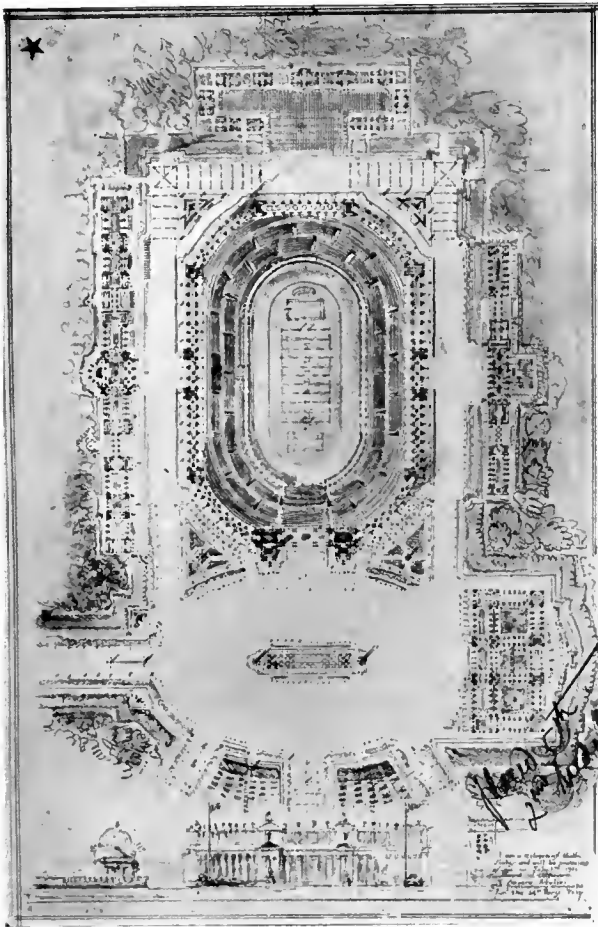

PLACED FIFTH—SECOND MEDAL
 H. S. ATKINSON
 "T" SQUARE CLUB, PHILADELPHIA, PA.

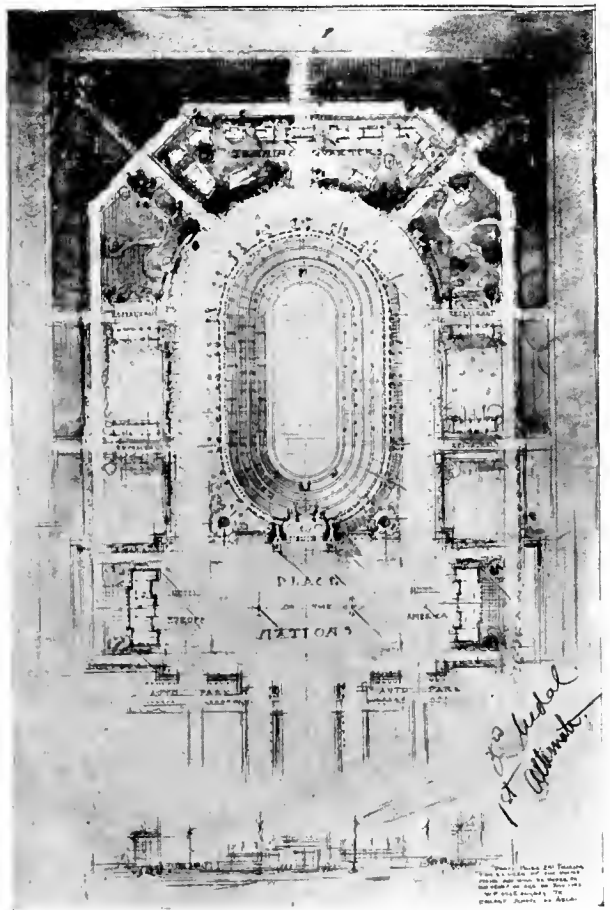

PLACED SIXTH (FIRST ALTERNATE)—
 THIRD MEDAL
 W. F. MCCAUGHEY, JR.
 CHICAGO SCHOOL OF ARCHITECTURE.

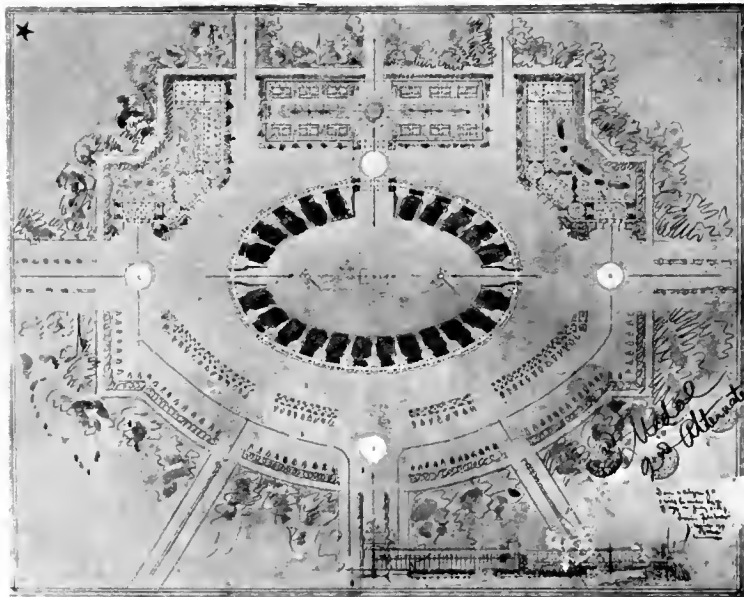

PLACED SEVENTH (SECOND ALTERNATE)—
 THIRD MEDAL
 L. FENTON
 ATELIER WYNKOOP

SECOND PRELIMINARY
 COMPETITION
 for the
 FOURTEENTH PARIS PRIZE
 ———
 STUDENT WORK,
 BEAUX-ARTS INSTITUTE OF
 DESIGN

Kitchen Wing, Mount Vernon, Va.

(See reproduction of original drawing by O. R. Eggers on opposite page)

IN a previous issue there was presented a series of sketches made by Mr. Eggers during a visit to Mount Vernon, the home of George Washington, on the banks of the Potomac River.

The kitchen wing shown in the present sketch is reached by the arcaded passage which projects above the boxwood hedge. The low building at the left is the kitchen. Its large expanse was necessary in the preparation of the food for the Washington family and the many dependents that were required in the conduct of so large an estate. The wide, open kitchen fireplace stands as it did in Washington's time, and is equipped with the many and ingenious utensils that contributed to produce the sumptuous banquets that marked the hospitality of a Virginia gentleman.

Owing to the well directed work of a patriotic society of women, Mount Vernon and all of its dependent buildings have been restored, and are now maintained as nearly as possible as in Washington's time.

It was here that the lordly Fairfaxes, who owned much of the surrounding country, were accustomed to visit, and it will not require a wide stretch of imagination by those familiar with Colonial customs to imagine the great deeds of cookery that were performed in this kitchen when these and other illustrious people were guests at Mount Vernon.



KITCHEN WING, MOUNT VERNON, VA.
THE AMERICAN ARCHITECT Series of Early American Architecture

612^a

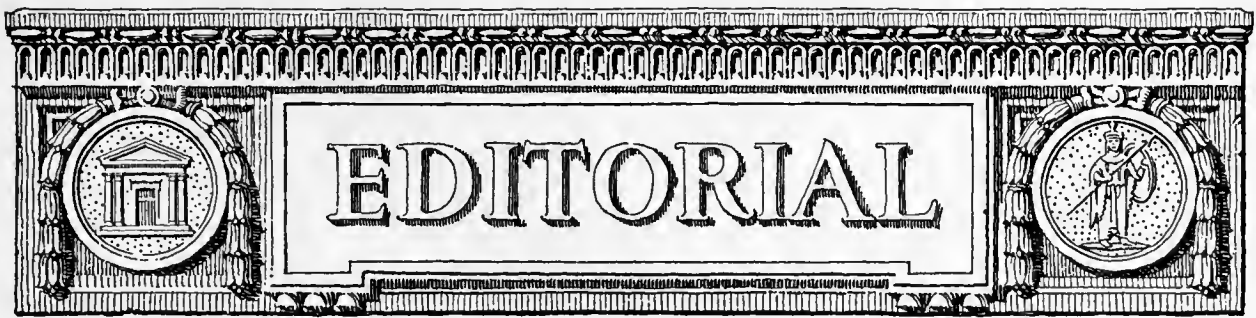

State Societies and the Institute

THE several State societies of architects were again invited to be the guests at the annual convention of the American Institute of Architects. This year there were representatives from Illinois, Indiana, New York, Michigan, Idaho and Florida, a total of seven delegates as compared with nineteen delegates last year. This does not necessarily indicate a lack of interest on the part of the State societies, but a patient waiting for the Institute to make a definite move by way of a medium for closer affiliation.

Few will doubt that it would be profitable for both organizations to have all architectural societies banded together for the mutual welfare of the entire profession. The State architectural societies are increasing in number every year; there are now twenty-one such societies having over 2,000 members. Their activities cover a wide range of problems purely local. The results obtained and obtainable are having a wide influence toward the betterment of the profession irrespective of affiliation.

It was through the efforts of the Illinois society that the first law governing the practice of architecture was spread on statute books. It is generally conceded that this law was the primary cause leading to the advancement of the curricula in the architectural departments of our technical institutes, colleges and universities throughout the land. Architectural education has greatly advanced through the opportunities and requirements resulting directly from the pressure and activities of State societies.

THEIR work in all local legislative matters pertaining in any way to building interests always brings about directly or indirectly a strong coalition of members and in a way that gives worth while results. It is difficult to understand how a public-spirited architect can today refuse to become a member of his State society, lending his hand and influence to forwarding and maintaining the splendid work that they are accomplishing; and always con-

ducted under a code of ethics no less honorable than that recognized by the American Institute of Architects.

It is hoped that the Institute will not procrastinate in regard to the splendid opportunity of securing the friendly and much desired co-operation of the State societies. Many practical suggestions are to be had in the paper to be found on page 629 in this issue presented to the Institute on the last day of its convention by H. B. Wheelock, and signed by delegates from Illinois, Indiana, Michigan and Idaho. Their suggestions are opportune and show an earnest desire on the part of the societies for close co-operation in all matters pertaining to mutual architectural affairs.

Improving Farm Buildings

IT is now more than two years since this journal first directed attention to the necessity for the betterment of farm houses and their surroundings. Letters from Governors of agricultural states were published, each executive warmly approving the movement.

Similarly, many of the state agricultural colleges expressed approval by letters and stated willingness to lend assistance.

The American Institute of Architects appointed a committee on farm buildings. This committee has zealously worked to forward this movement, with but scant encouragement for a continuance of its efforts. It should be continued and stimulated by recognition of what it has done.

Institute Chapters were urged during the recent convention to follow the good example of the Minnesota Chapter and organize for the best development of the small house. Why not include farm buildings? Why forget the farmer who represents the first of our industries? Why not give the necessary consideration to his surroundings? How shall we keep our young men and women on the farms if we fail to take the same interest in their environment that we show to dwellers in our suburban communities?

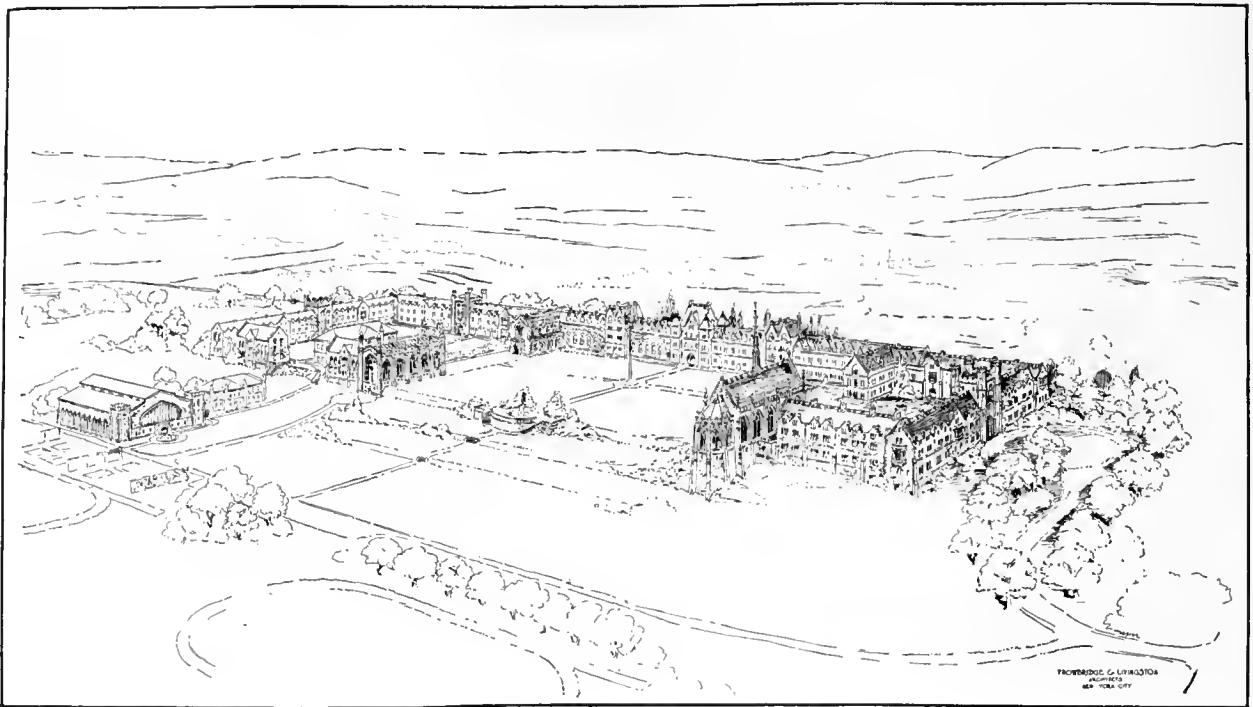

ARCHITECTURE of the SMALL COLLEGE

By S. B. P. TROWBRIDGE, Sc.D.

IN many respects we are, or have been, a nation of opportunists. We have used up our forests, we are using up our land, we waste our resources, without thought of the future. The same lack of foresight has characterized the planning of our cities, towns, institutions, and even our houses.

Most of our cities have been built up on the gridiron principle without regard to local conditions. Our institutions are too often conglomerations of different types of buildings in different styles of architecture, scattered about in haphazard fashion to satisfy temporary necessities, rather than to become parts of a well considered whole.

This with a few notable exceptions has marked the growth of the small colleges into great universities, for it must be remembered that fifty years ago all our universities were small colleges. It is still true today of many of our seats of learning, although it is becoming more and more evident to the Trustees of these institutions that adaptability to site and natural conditions, orientation of groups and buildings to give the maximum of light and air, convenience of access and ease of intercommunication, traffic problems, correlation of interdependent departments as well as unity and harmony in design are all essential elements in the problems of housing and teaching large numbers of men and women.

It is unquestionably true that an orderly and systematic distribution of units, based upon a serious study of all the present conditions and future pos-

sibilities, conduces not only to economy, ease of administration, beauty of surroundings, health and happiness, but also to that calm and serious atmosphere so necessary to the academic mind. The application of these principles is much more simple in the case of the small college. If the great university has gone too far in its rapid and ever widening scope, it is not too late for the small college, particularly if it has adopted what may be called an ideal student body unit, to proceed with an architectural plan conceived by one man with one coherent set of ideas.

Trinity College at Hartford, Connecticut, is working out such a scheme.

The conditions for its realization are ideal. Possessed of a splendid site, ample room, a magnificent view in every direction, it already has an existing group of well designed and well built buildings, Gothic in style, and perfectly adaptable to the enlargement necessary for modern requirements.

It is now proposed strictly to limit the number of students and to fashion the whole educational plan to this limited number. In a community limited to five hundred students, not only can the chapel, the dormitories, the library, the refectory, the assembly halls, the lecture and recitation rooms, the gymnasium, and the athletic fields be proportioned properly and adequately to the required numbers, but the whole institution can be planned and designed as one harmonious whole.

THE NEW BOSTON COLLEGE*

Ralph Adams Cram Describes Its Present Architectural Beauty and Its Satisfactory Progress

FOR some years everyone who has seen the beginning of the new Boston College has realized that something was happening that was immensely significant. The extraordinary beauty of the site and the striking qualities of the architecture make a combination that not only gives immediate satisfaction to the eye, but stimulates the imagination as to the future. Certainly, here is a scheme under way which promises to work out into one of the greatest artistic features of Massachusetts, even of the United States. Higher education demands, and has by no means always received of late, the finest possible architectural embodiment, for the silent influence of good art is perhaps quite as potent along educational and cultural lines as is the scheme of studies and the discipline involved. When this higher education is knit up with religion, the demand becomes even more insistent, and when, by chance, this religion is the ancient Catholic faith of the world, then indeed we have not only the greatest possible opportunity but the most imperative demand for the best that men of today can provide.

Every architect knows, and I should say every layman as well, that in this particular case the institution itself and the architects are meeting the evident necessity in the most appreciative, intelligent and brilliant fashion. The great tower has been a landmark and a joy to the eye ever since it was erected. The faculty building began to indicate future possibilities, and now the designs that have been made by Maginnis & Walsh for the chapel, the library, the science building and the gymnasium go still further in their stimulating promise. Usually one gets in American colleges one, or perhaps two, structures conceived in the right spirit, worked out in logical style and admirable design mixed up with heterogeneous edifices of very varied value. Occasionally, as for example at Princeton, this number is increased to a preponderant majority. Seldom, however, does the opportunity offer itself for a complete and consistent group of all the educational buildings, planned by one hand and forming a consistent whole. Boston College is one of the exceptions, and from every possible point of view the general public must look with interest on the working out of the project, at the same time giving it every possible support, financial and otherwise. There are no limits that can be set to the cultural and civilizing value of such a power as this.

It is interesting to see in how masterly a fashion the architects are dealing with each element of the

problem. There is sufficient variety, explicit and effective differentiation between the nature of the several buildings, and yet it all hangs together with notable consistency. There is no feature or factor in any educational institution which is of greater value, and is more often neglected or altogether abandoned than the chapel, because we have pretty well learned by this time that there is no effective education that is not interpenetrated by religion at every point. The position and the design of the proposed chapel for Boston College fortify this principle. The scheme itself is of the simplest, and, therefore, of the best, a chapel that is a chapel, and neither a miniature cathedral, a parish church or a more or less spiritualized bungalow. The whole scheme is fine, simple, straightforward and dominating.

Altogether, the profession of architecture must feel it is already heavily in the debt of Boston College and its architects. How deeply in their debt must be the general public is a thing that will be perhaps more clearly recognized as the great scheme is worked out to its conclusion. Certainly, after a precedent such as this, there is no excuse for organized education or organized religion to revert to the bad old ways of cheap, ugly and ignominious architecture. A standard is set here toward which all energies in the future should be bent with the idea of approximation, even if not of emulation.

Italy Wants Art Treasures

ASIDE from the artistic beauty attached to twenty-two priceless Pinturicchio ceiling panels which are now on exhibition in the Metropolitan Museum of Art in New York City, there is added interest in the history of the panels.

There is also an element of romance connected with the current exhibition, for the Italian Government is keenly desirous of learning just how and in what mysterious manner some of its most treasured works of art disappeared from the Palazzo del Magnifico in 1902. And the Italian Government wants those art treasures back in their old resting places and is willing to pay for them.

It was about 1508 that Pandolfo Petrucci, il Magnifico, or tyrant of Siena, commissioned Pinturicchio to paint and decorate a ceiling in the reception hall of the Palazzo. These panels are described as the choicest gems of their kind in the Renaissance art.

In some mysterious manner these ceiling panels found their way to France and were purchased from a responsible art dealer in 1914.

* Reprinted in part from Mr. Cram's article in a recent issue of the *Boston Transcript*.

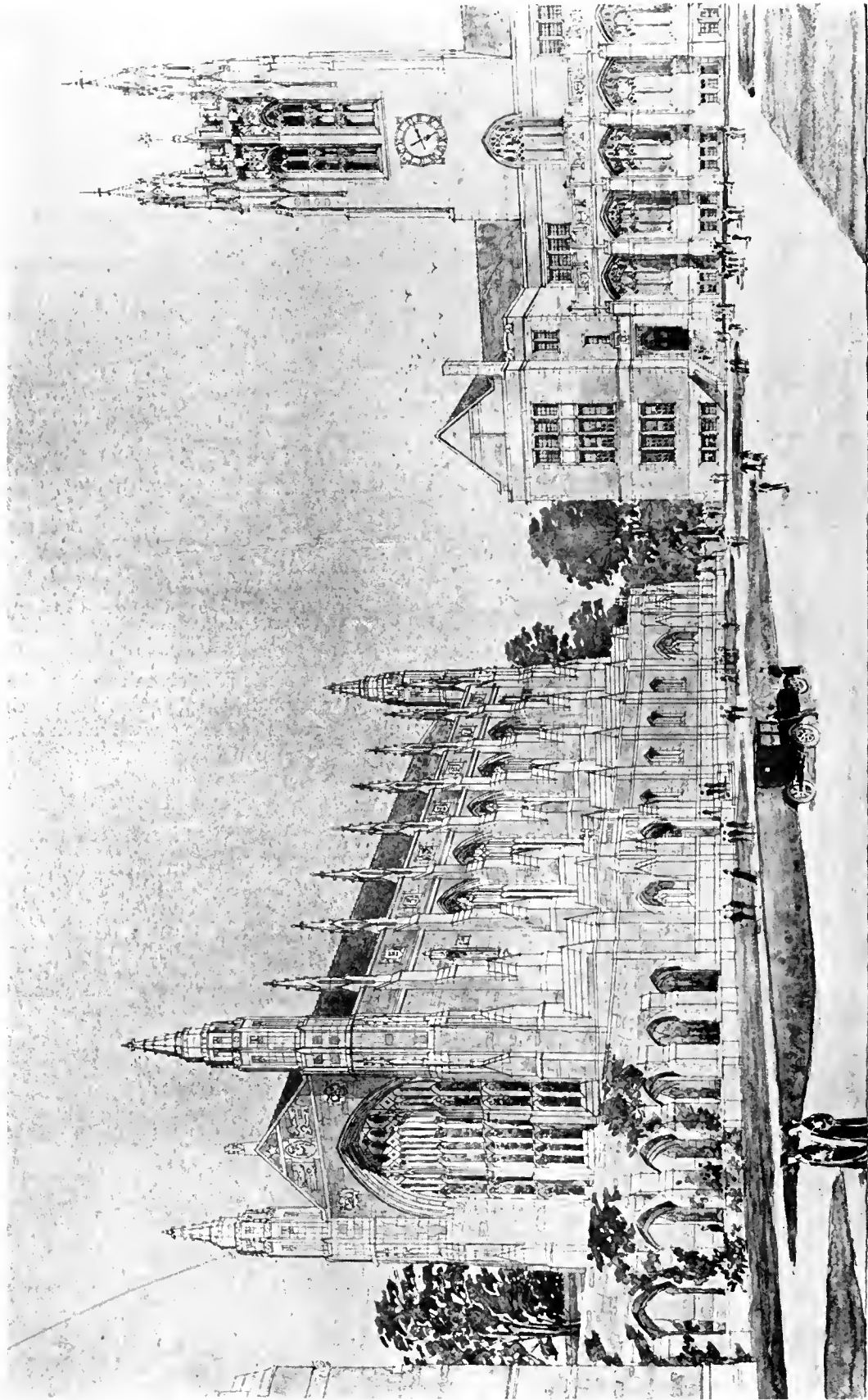

Chapel for Boston College, Fenton, Mass. Designed by William E. Kimball, S.S. President of the Massachusetts Institute of Technology, Boston, Mass.

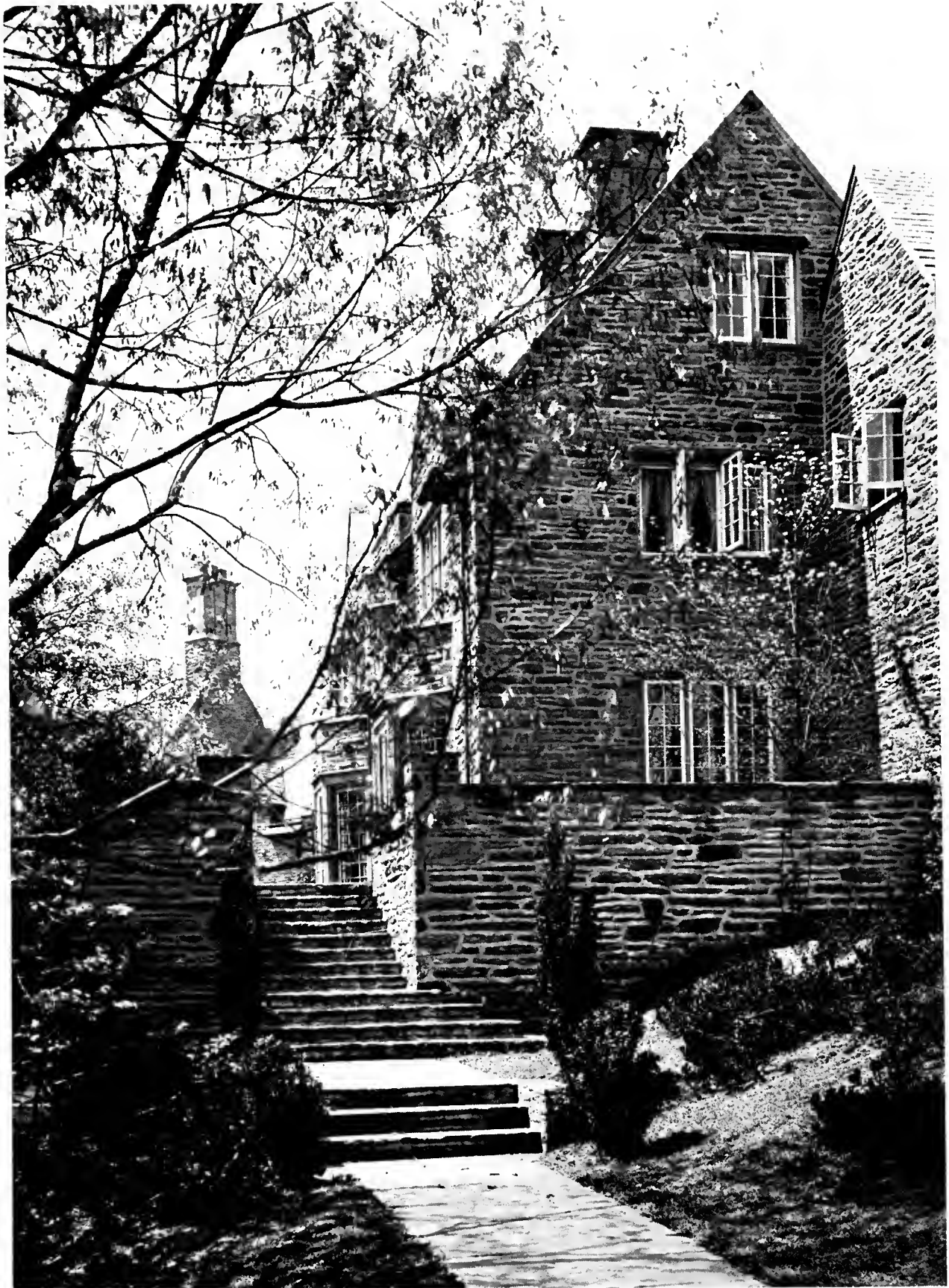

HOUSE OF MR. SPENCER ERWIN, CHESTNUT HILL, PA.
ROBERT R. McGOODWIN, ARCHITECT

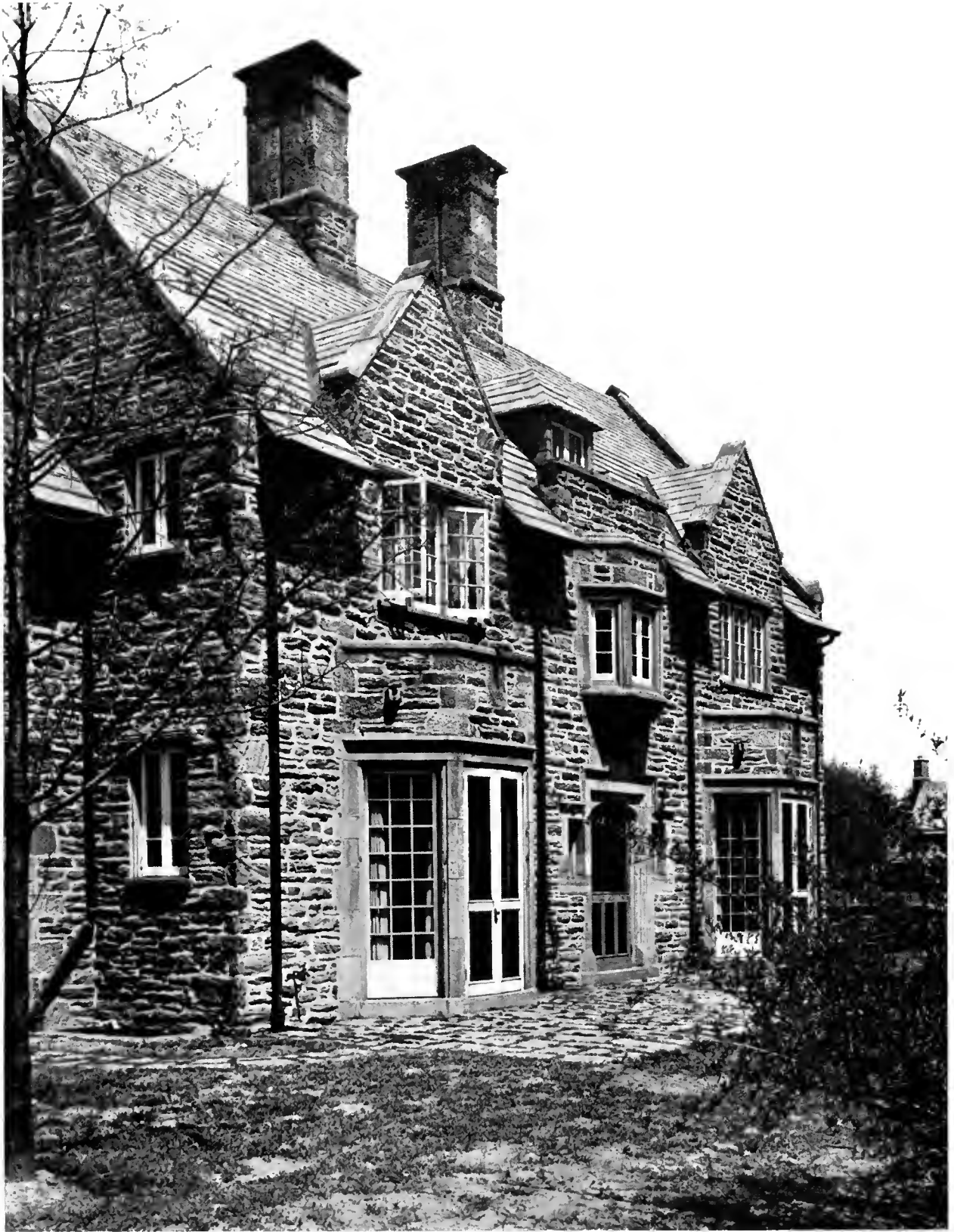

HOUSE OF MR. SPENCER ERWIN, CHESTNUT HILL, PA.
ROBERT R. MCGOODWIN, ARCHITECT

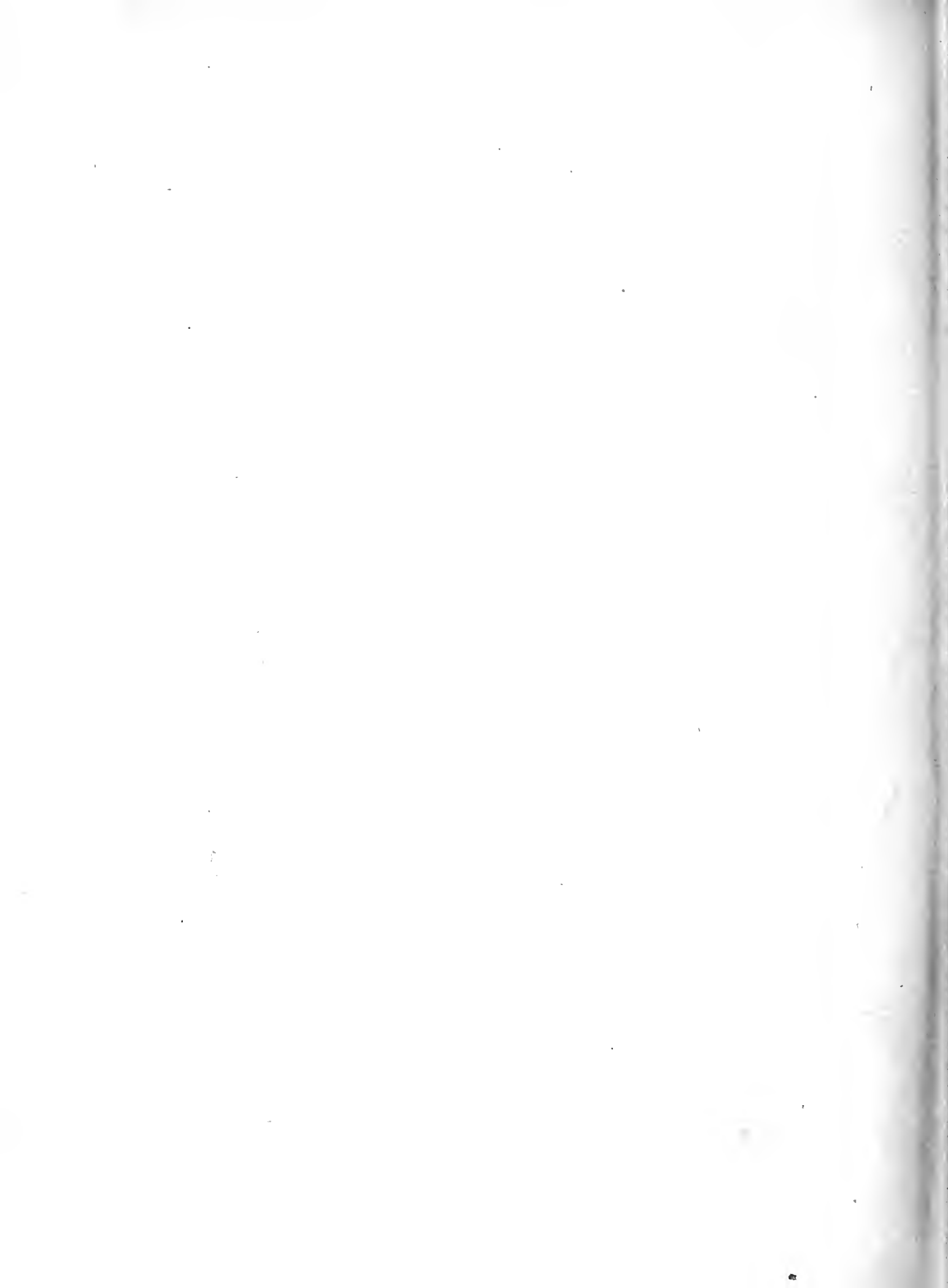



HOUSE OF DR. GEORGE WOODWARD, CHESTNUT HILL, PA.
ROBERT R. McGOODWIN, ARCHITECT

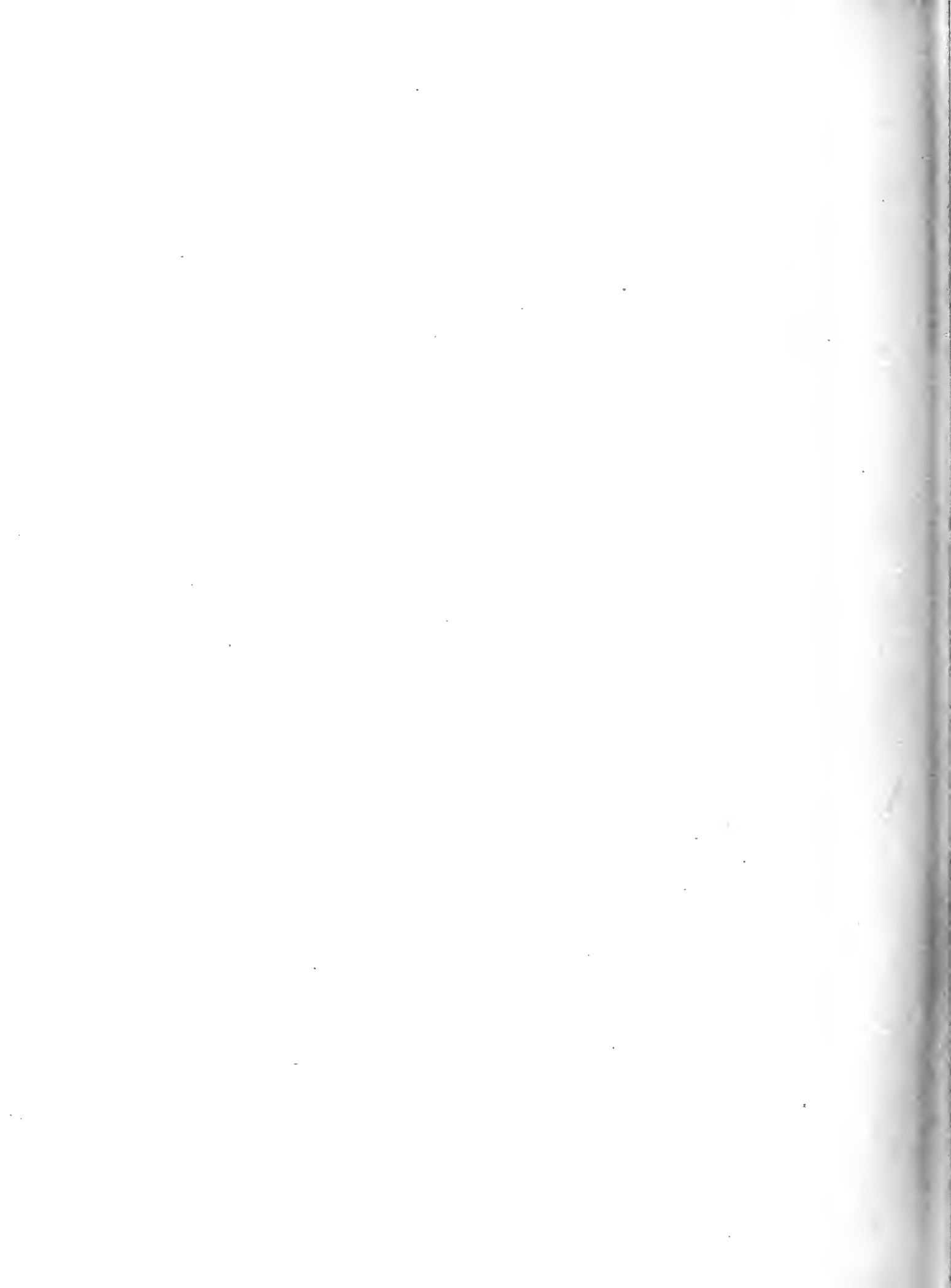

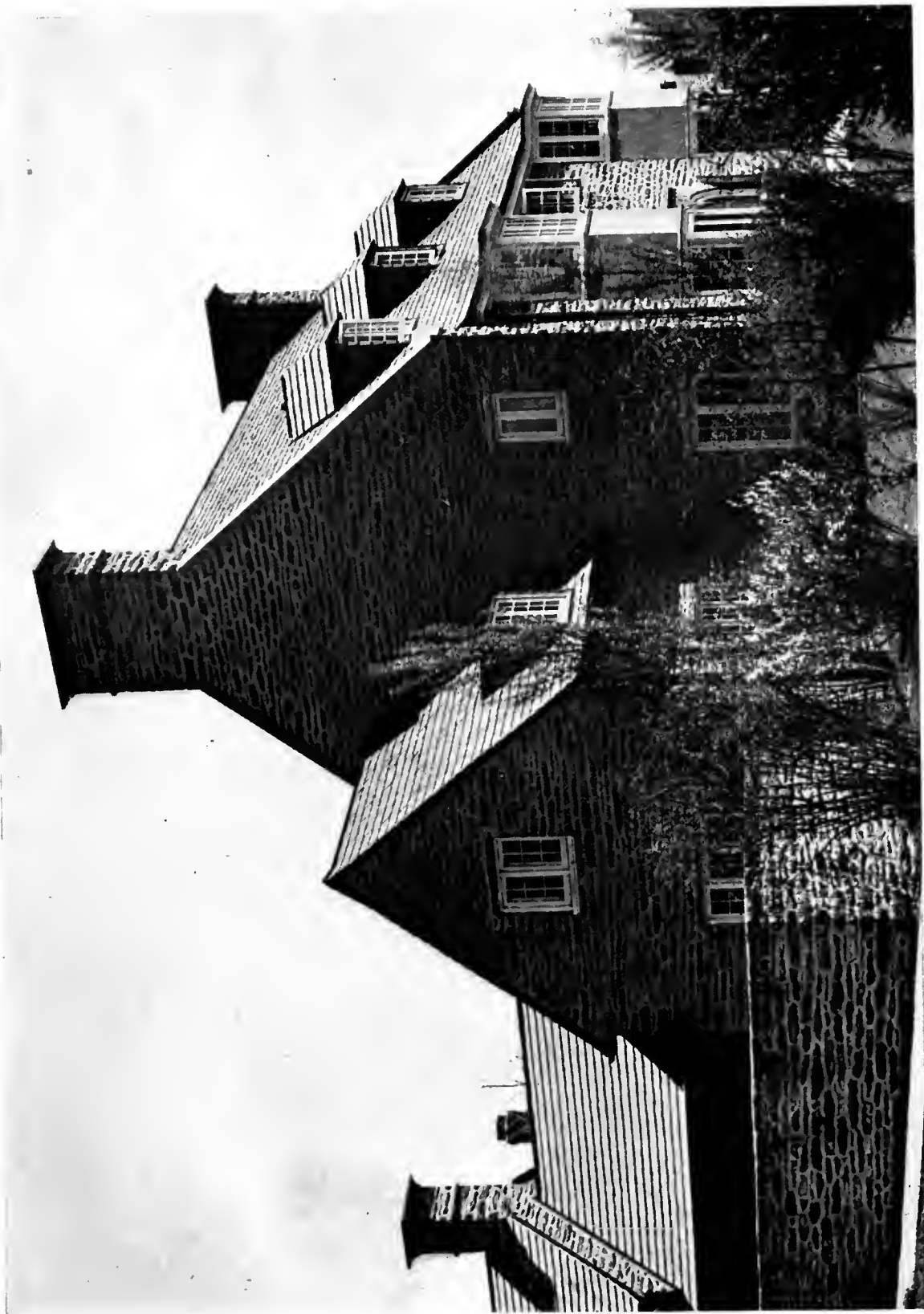

HOUSE AT CHESTNUT HILL, PA.
ROBERT R. McGOODWIN, ARCHITECT

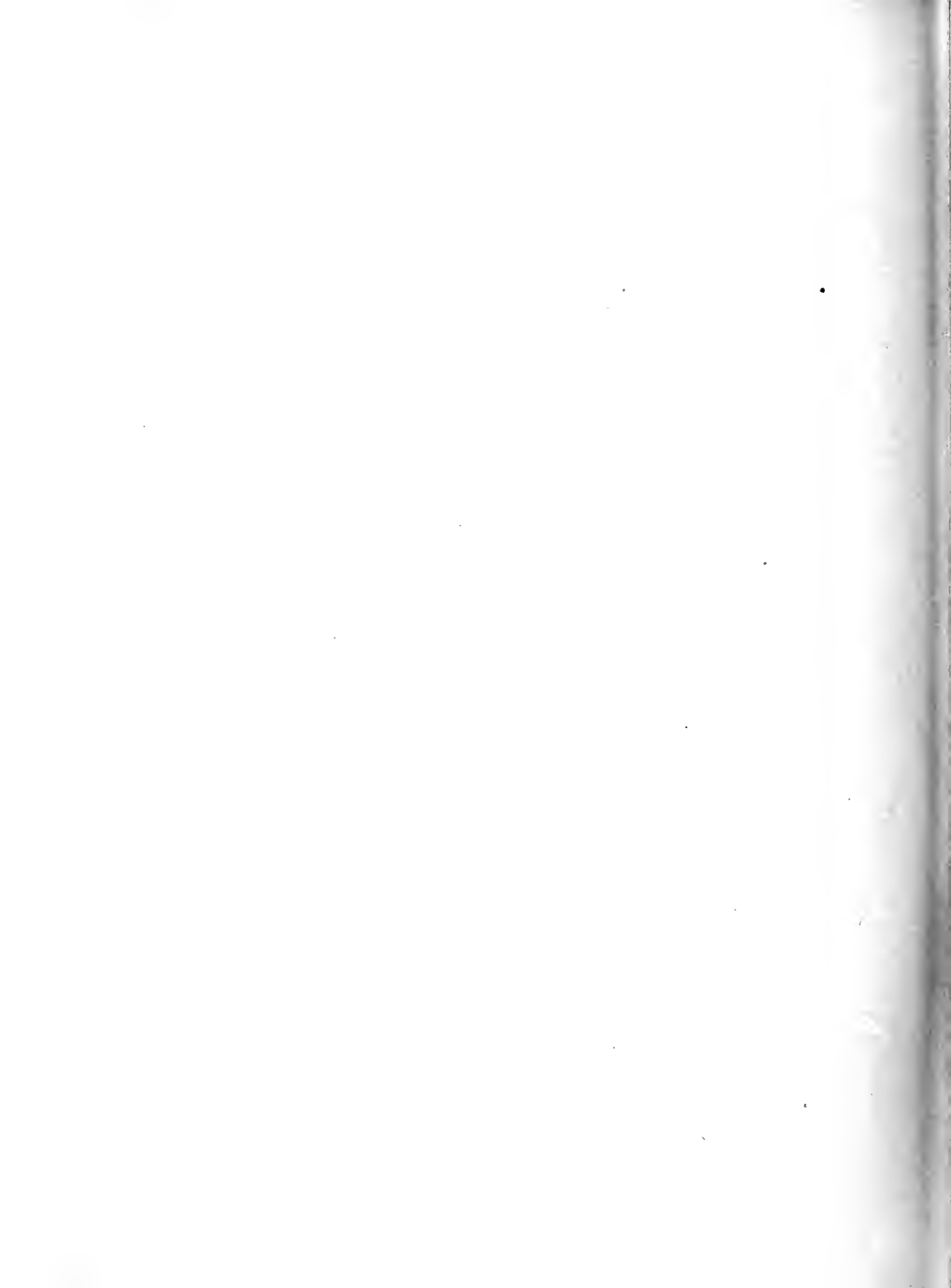



HOUSE OF MR. WALTER SCHWARTZ, CHESTNUT HILL, PA.
ROBERT R. McGOODWIN, ARCHITECT

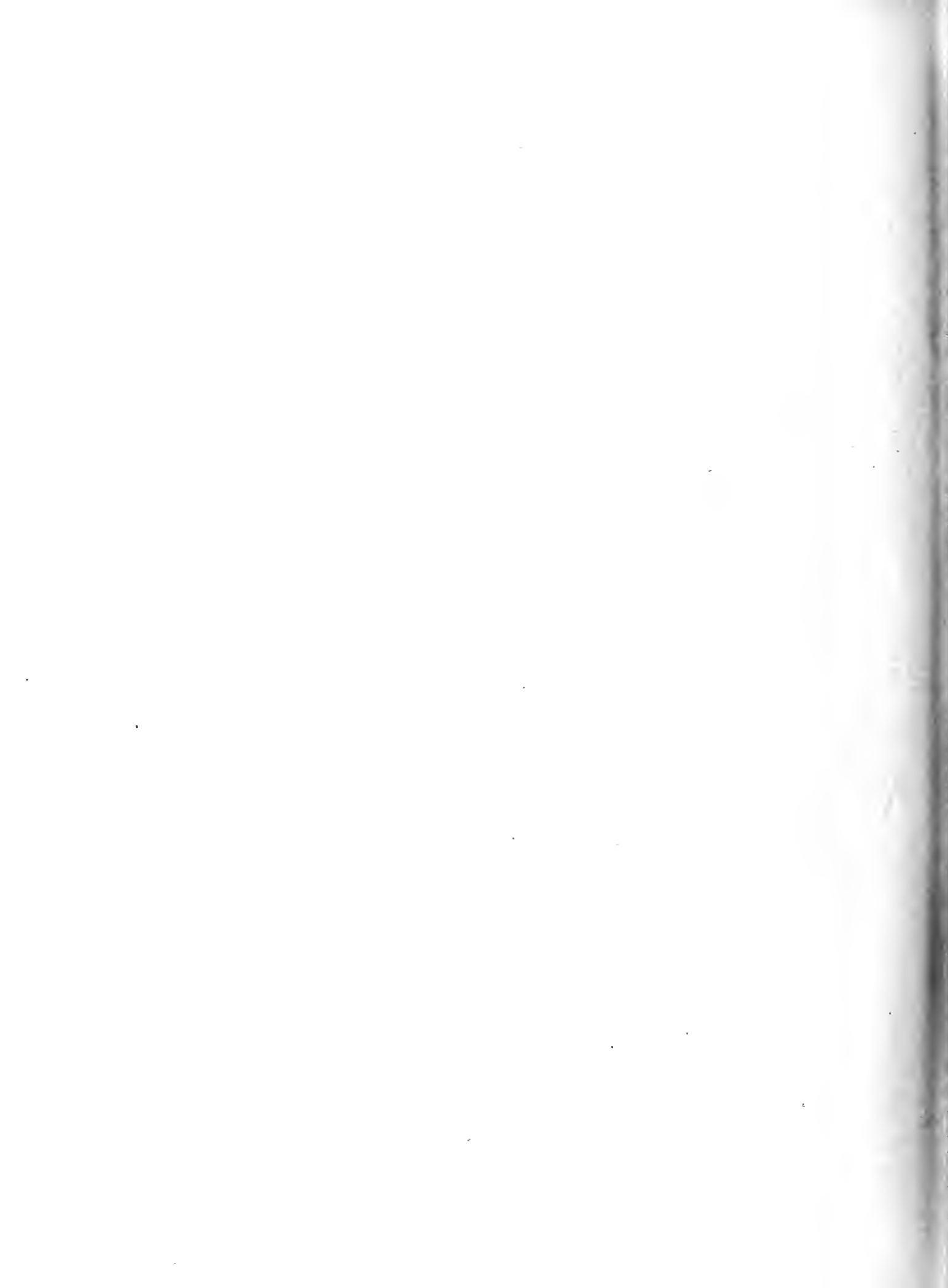



HOUSE OF MR. NORMAN ELLISON, CHESTNUT HILL, PA.
ROBERT R. MCGOODWIN, ARCHITECT

6/6





HOUSE OF MR. NORMAN MACKIE, CHESTNUT HILL, PA.
ROBERT R. McGOODWIN, ARCHITECT





HOUSE OF MR. NORMAN MACKIE, CHESTNUT HILL, PA.
ROBERT R. MCGOODWIN, ARCHITECT



BROADWAY THEATRE, SOUTH BOSTON, MASS.
BLACKALL, CLAPP & WHITEMORE, ARCHITECTS





BROADWAY THEATRE, SOUTH BOSTON, MASS.
BLACKALL, CLAPP & WHITTEMORE, ARCHITECTS

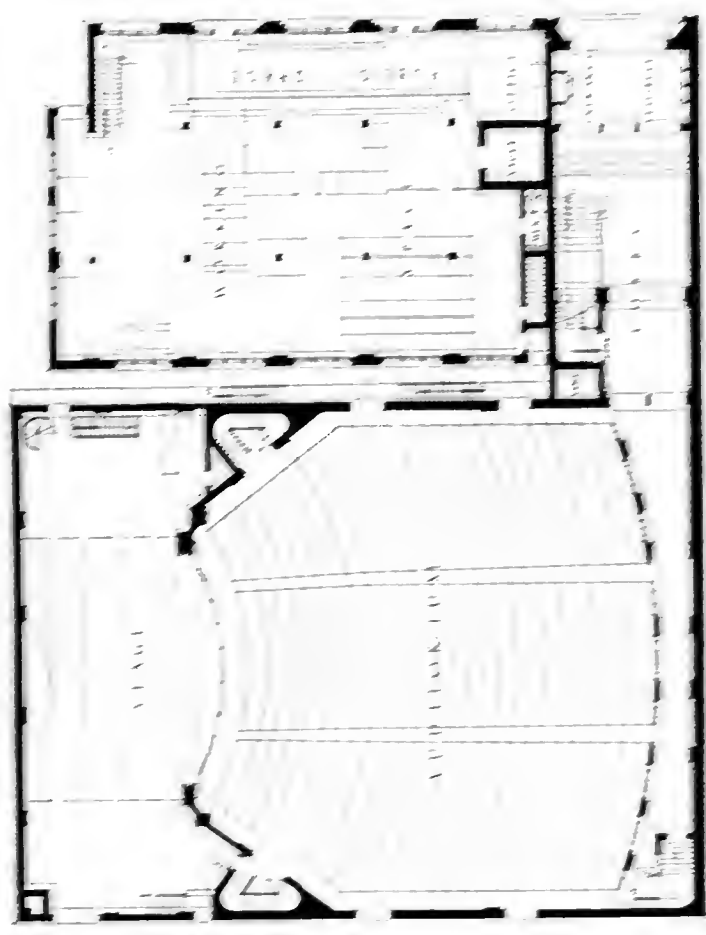

VIEW IN LOBBY AND MAIN FLOOR PLAN
 BROADWAY THEATRE, SOUTH BOSTON, MASS
 BLACK, CLAPP & WHITEHORN, ARCHTCTS



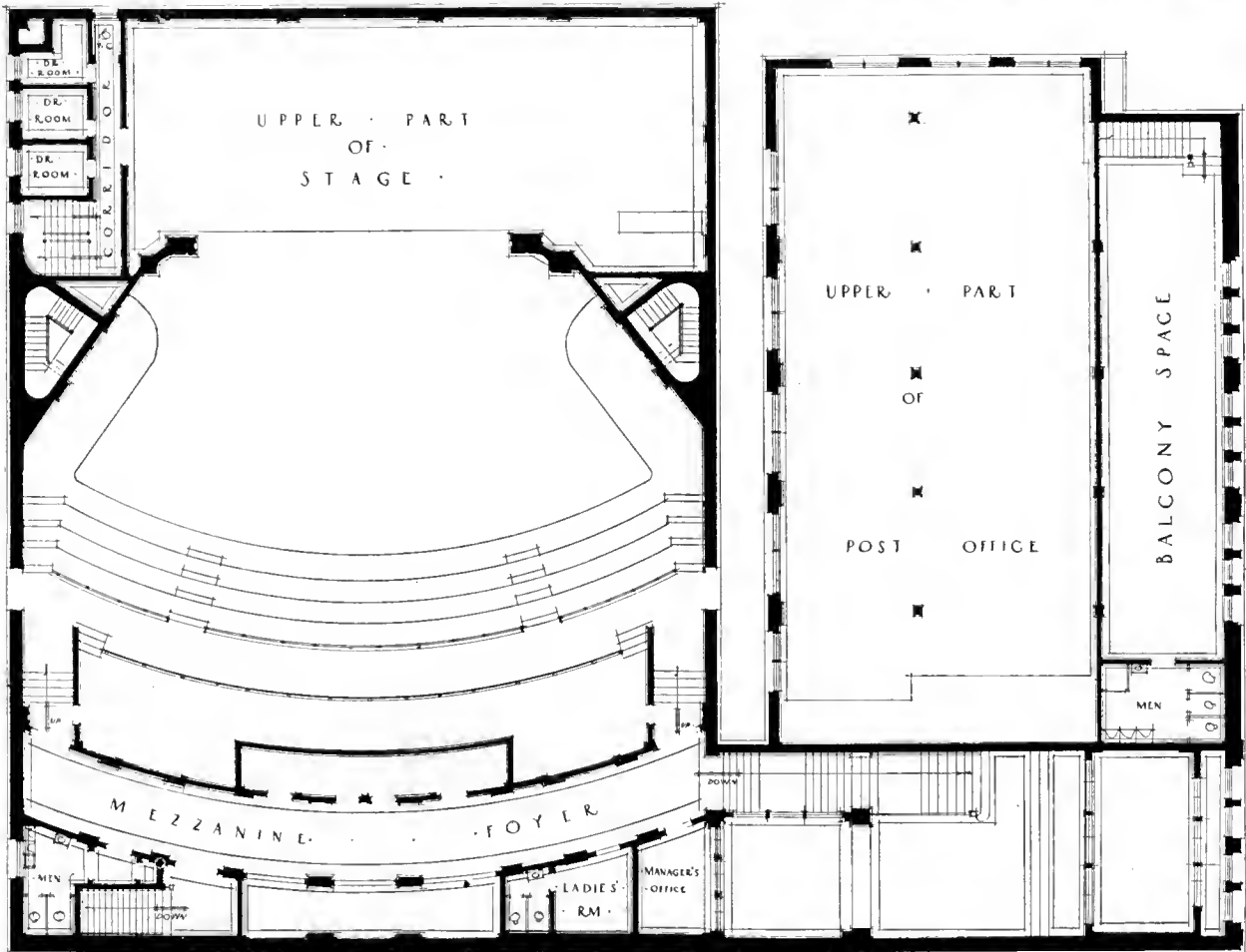

VIEW OF MEZZANINE FOYER AND PLAN OF MEZZANINE FLOOR
 BROADWAY THEATRE, SOUTH BOSTON, MASS.
 BLACKALL, CLAPP & WHITTEMORE, ARCHITECTS

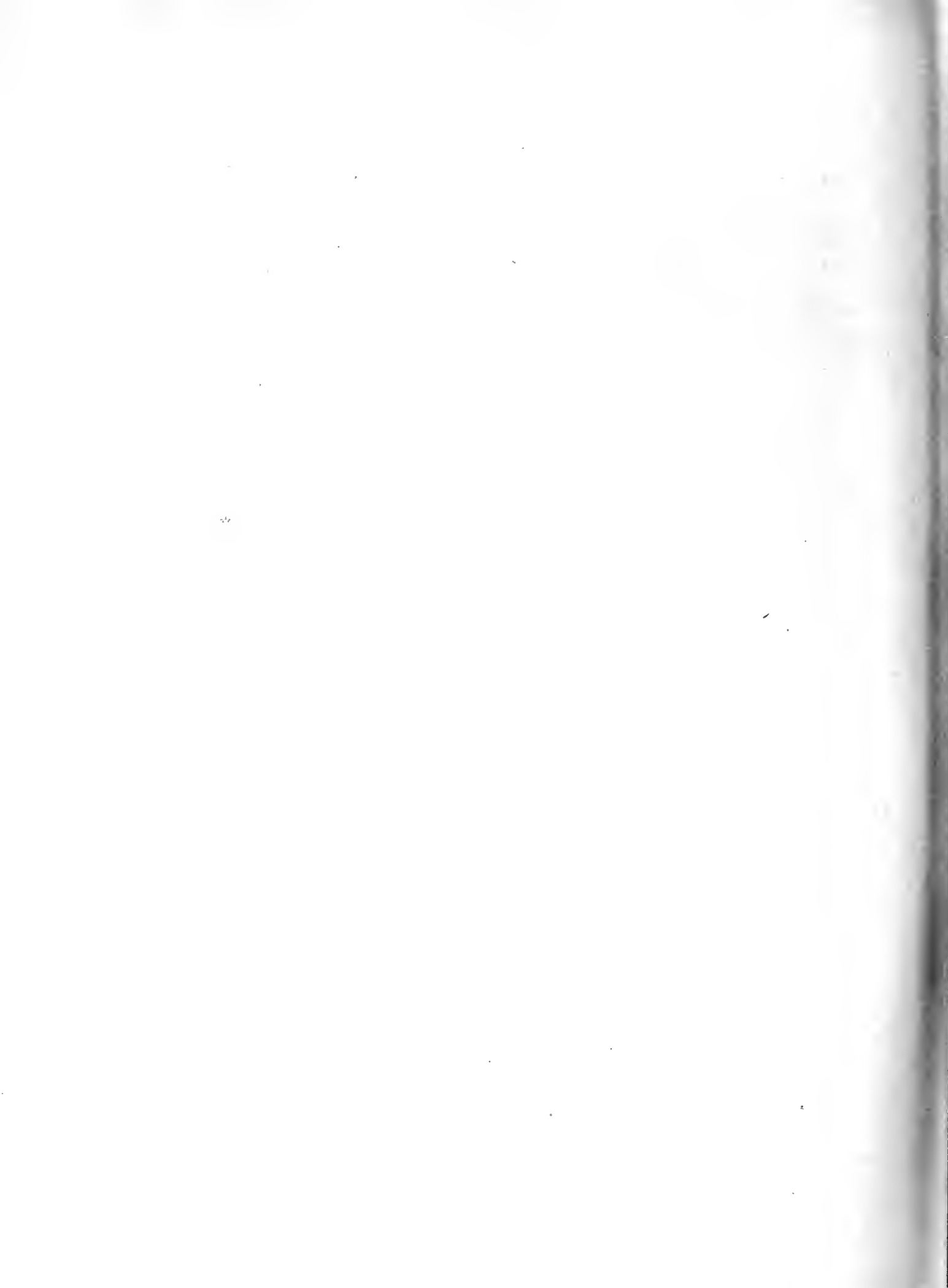

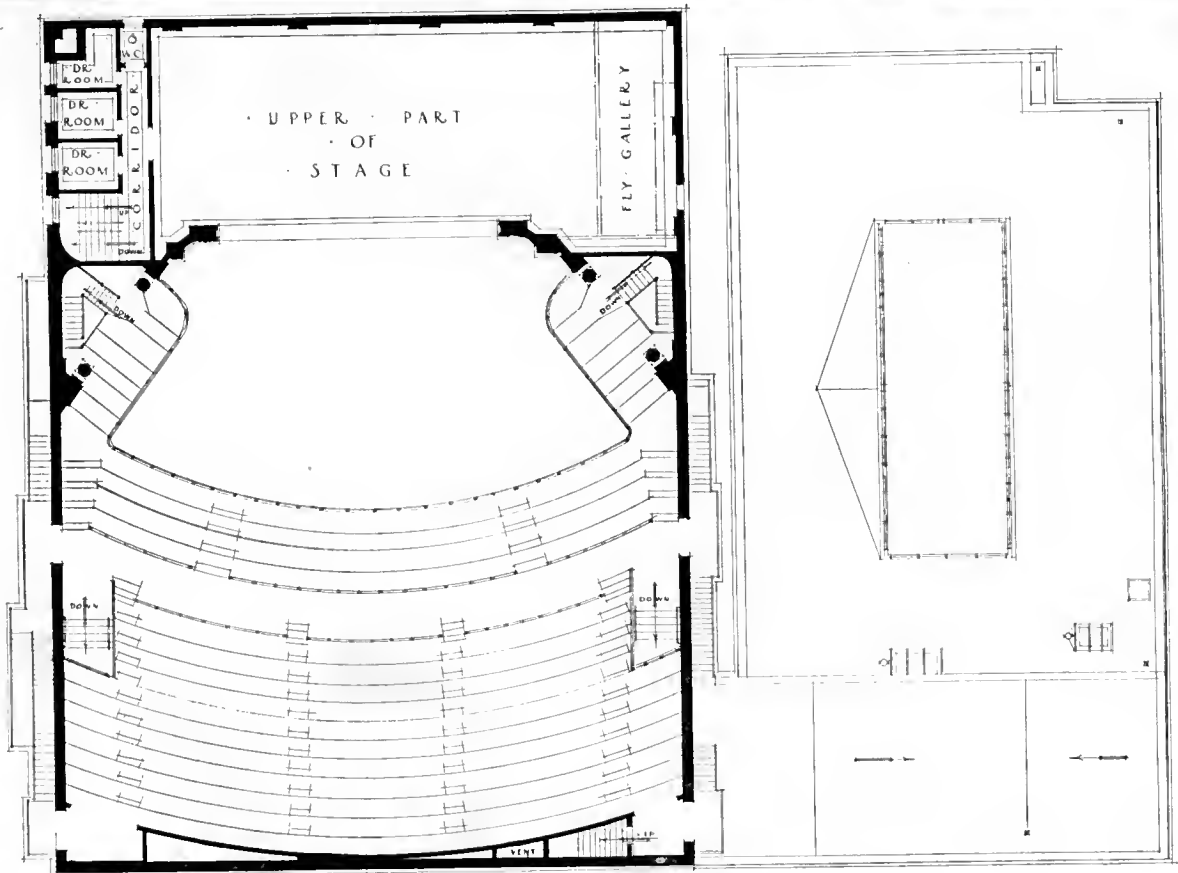

VIEW LOOKING ACROSS BALCONY AND BALCONY FLOOR PLAN
 BROADWAY THEATRE, SOUTH BOSTON, MASS.
 BLACKALL, CLAPP & WHITTEMORE, ARCHITECTS

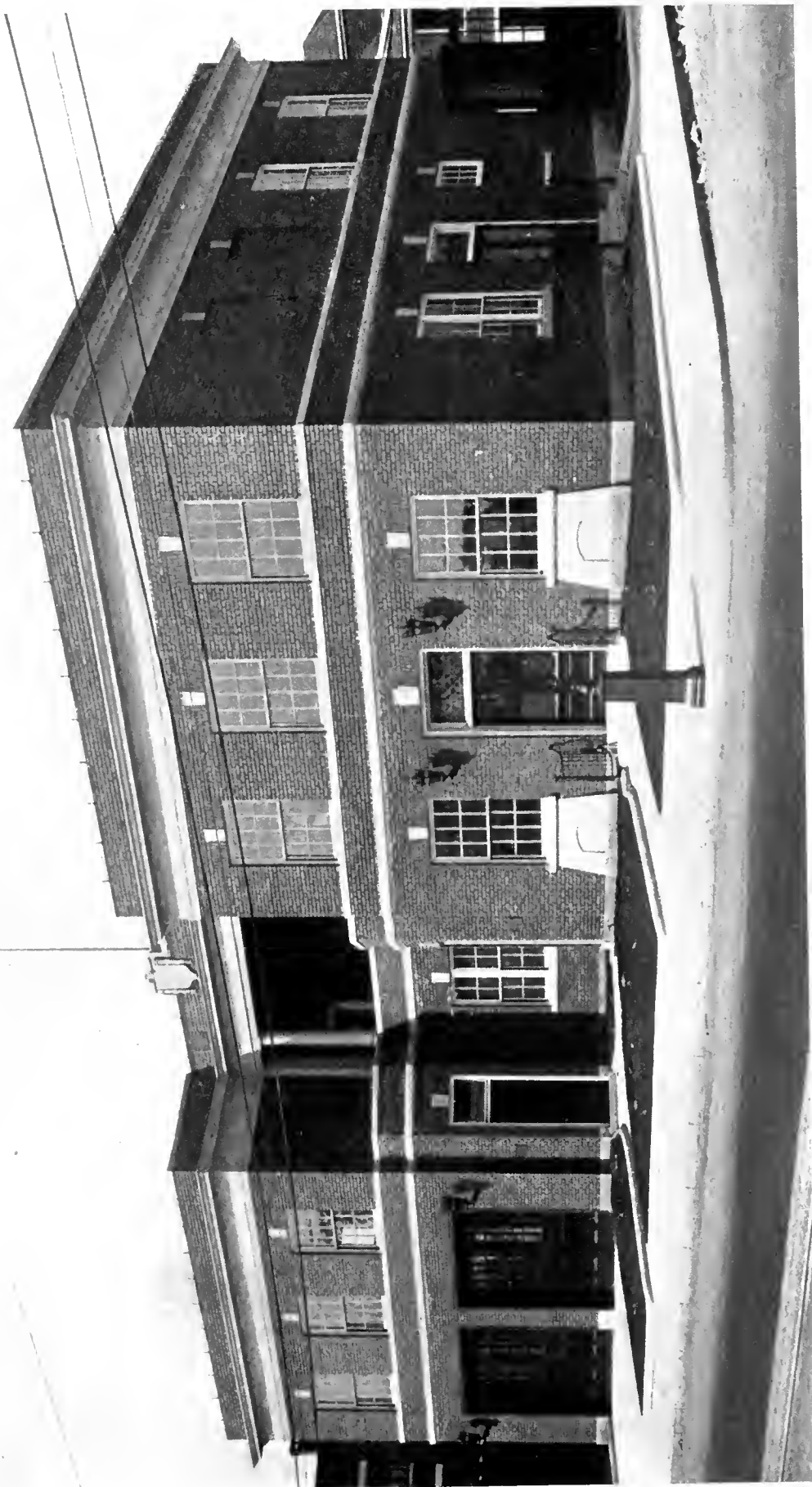

FIRE AND POLICE STATION FOR THE CITY OF BRIDGEPORT, CONN.
LEONARD ASHEM, ARCHITECT



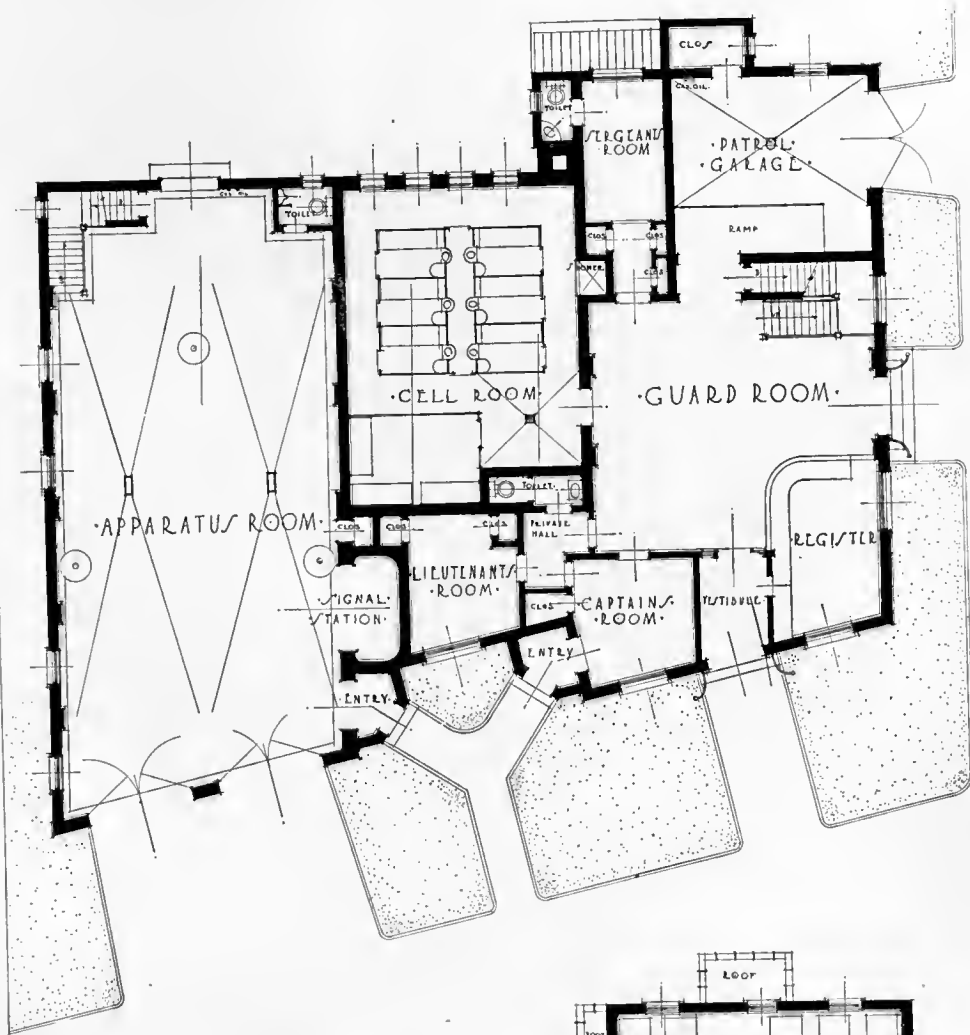

FIRE AND POLICE STATION FOR THE CITY OF BRIDGEPORT, CONN.
LEONARD ASHEIM, ARCHITECT

616 15





HOUSE OF G. S. GAYLORD, NEENAH, WIS.
CHILDS & SMITH, ARCHITECTS

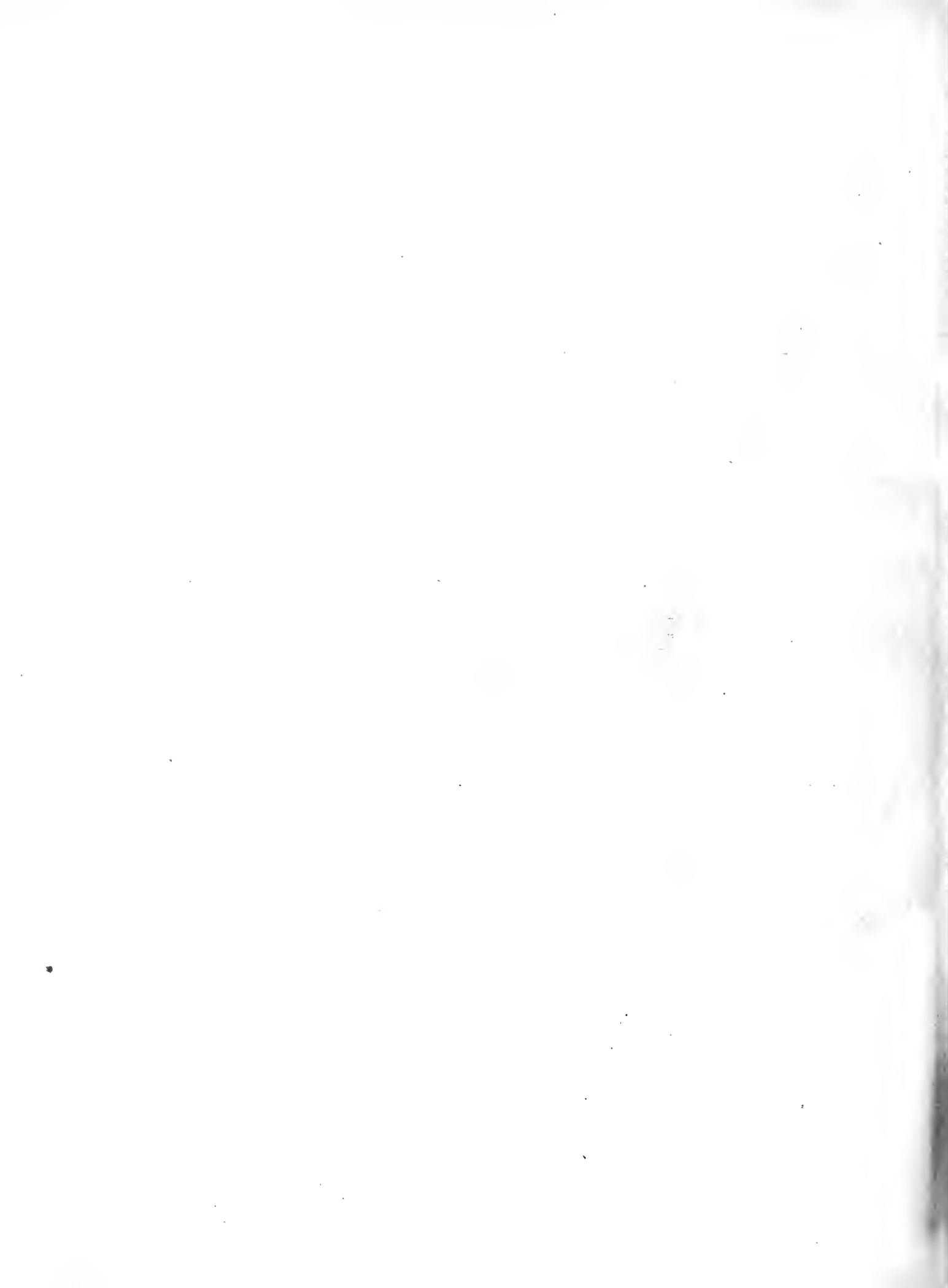

Planning High Buildings

(Continued from page 608)

shows the new and the old building. This illustrates the present height to which buildings on 42nd street are permitted to go. I would like to call attention to the treatment of the side wall, which the architects of this building were good enough to carry out in harmony with the scheme of that building. Under normal conditions those blank walls would be left just of plain brick with scattered openings. This new law has done more to call the attention of architects to the fact that there is something besides a

front in connection with a building than anything that has happened in recent years. The fact that they get these set-backs, that they have to look at the upper stories of their buildings, has resulted in their studying those things from every angle, making their buildings appear right from the front and from the side and from the top. I think that the airplane view is just as architecturally important in the future, as any other view has been, and I believe the time has passed when we can design buildings as a flat sheet of paper facing a street. From now on we must look at our buildings from every possible angle.

THE DISCUSSION

Mr. Gray: I would like to suggest that while these examples are conspicuously applicable, the same principles are equally applicable to similar places, and there is a general movement on foot, from one side of the country to the other, to get zoning laws in operation. It is really a simple procedure, because of the fact that it calls for a very small appropriation. It is a matter of legislation, calling for a survey and preparation of maps. That work has been done to an extent, now, so that the method is getting fairly well standardized and can be done fairly rapidly so results can be gotten quickly.

The increase in valuation of properties resulting from these protective measures is marked. Legally they are restrictions, but as a matter of fact they are protective measures to prevent individual properties from being ruined by undesirable structures on adjoining properties. From the fact that they do increase land value, and consequently taxes, a problem is presented. It is a very simple thing to get established in any community, as is evident by the fact that there are today, I think, about 29 cities and towns in the country which have zoning ordinances. It is desirable to proceed by getting a State Enabling Act. In all states that is not necessary; where the cities have proper powers this is all done under the police power of the states delegated to the cities. It has been thoroughly sifted out in all the courts, so that there is no question about legality, and there are no condemnation proceedings in connection with the method.

Mr. Hammond, of Illinois: Mr. Corbett spoke of the Bush Terminal Building, as the first building built under the old zoning law, which was shown on a slide, and the other under the new law. Merely for information I would like to ask Mr. Corbett just what is the general difference between those two laws. Has the old law been amended recently?

Mr. Corbett: There was no law regarding the height of buildings until this present law, which I have just described, went into effect. The old law allowed the buildings to go as high as the architect wanted to carry them; or, as high as his clients would

let him carry them, which is more to the point. The only restriction was one as to materials.

Mr. Hammond: So that the set-backs, in the case of the Bush Building, were not required?

Mr. Corbett: No.

Mr. Hammond: That building was planned with those set-backs, and I thought there might have been that reason for it.

Mr. Shaw, of Illinois: I should like to ask if there is any protection for the neighbor on the inside lots? He seems to think of his neighbor on the other side of the street, but no protection seems to be given on the inside line.

Mr. Corbett: There is no restriction on the lot lines. The idea of the law was simply to get light and air into the street. There is a restriction on the rear yard. The set-back would have to follow a somewhat similar line. It is not quite the same. But there is a restriction on the rear yard which would make a building come to a pyramid at the top if it were carried to its maximum point. Of course, as I explained, the building on 25 per cent of the area of the lot can go to any height.

Mr. Baird, of New York: I would like to ask Mr. Corbett to explain how it is that on a perfectly flat party wall he gets the appearance of texture, light, and shade. That is the interesting side of the Bush Terminal Building.

Mr. Corbett: In that particular building the side walls were more conspicuous than the front, and it seemed to me that it was an opportunity to demonstrate the possibilities of treatment of a side wall.

The way that I secured the particular result there was by making a design of the building as I would like to build it if it had been standing free. Then I make a rendering of that design with shadows definitely cast at 45 degrees, with high lights and shadows. Then I interpreted that rendering in flat brickwork by the use of dark brick, light brick, and the brick tones of the building itself. That gave us a similar treatment on all faces of the building which did not take an inch of room that would not have been taken in the normal, ordinary type of

building, and the cost of laying the brick in that particular form was really negligible, viewed in the enhanced appearance given to the building.

Mr. Holtzman, of Illinois: Mr. Chairman, in this connection I would like to make a suggestion that the architects throughout the country take upon themselves the initiative in getting zoning laws established in their communities. In most of the states it will doubtless require an Enabling Act from the State Legislature to permit the cities to pass zoning laws that will stand the tests of the courts.

The reason that I speak of this is because of the extended experience we have had in Chicago with an effort to get a law so that the city of Chicago could be zoned. About two years ago the City Council began the formulation of an Enabling Act to present to the Legislature, and the committee charged with the duty asked the Women's Club, the City Club, and one or two other clubs of Chicago, to come and help. I happened to be sent by the City Club to this meeting, and during the discussion it was perfectly evident that no one there knew anything about what they were trying to do. Towards the end of the meeting I suggested to the chairman of the meeting, whom I happened to know personally, that there were two bodies of experts in the city that knew something about planning, and that this matter of zoning was probably largely a matter of planning a city within the old city already in existence. I mentioned the Western Society of Engineers and the Illinois Chapter of the American Institute of Architects, who I thought would be perfectly willing to help; and he confessed that it never occurred to anybody to think of engineers or architects in connection with this business.

We have gotten busy, however; the situation is now changed and they have even asked us to come, after two or three years' experience with them, to discuss with them financial matters. I speak of this because I am sure that the architects in other parts of the country can take a very practical and a very desirable lead, from the point of view of the public welfare and the public good; especially along the line of this matter of zoning.

Mr. Fenner: May I say one further word, seconding all that Mr. Holtzman and Mr. Gray have said as to the importance of the results?

Also I would like to say, as a member of the Commission which studied the problem in New York for three years, leading up to the passage of the law, that I would not like to have this meeting get the impression that the law, with its results as reflected on the screen, is in any way an ideal law. The heights permitted are far too great to be ideal. We had to meet as well as possible a condition which existed. I want to say that for the benefit of any of the smaller cities which may now be discussing zoning and height restrictions. Do not permit your restrictions to allow what had happened in New York before we passed our zoning law.

Mr. Malcolmson, of the Michigan Chapter: I would say that in connection with the zoning law passed at Lansing, at Detroit, and in working with that in the last few years, we have been confronted with one condition. The center of our city has a great many tracts of ground that are not built up. In trying to get the property holders of these particular lots to assist us in the zoning movement, we found that they were forced, in many cases, to build 32 and 33 stories to obtain sufficient height so as to get sufficient rental to make it profitable to build. We found in several cases, when we went to that height, that we had to sacrifice so much space for elevators and exits that we lost more space than we gained. The problem to solve was this: The builder who had one of these lots with a three or four story building on it, with a long life of usefulness, would be taxed so much that it would cost him \$30,000 a year from his income. He had to go up to thirty stories to get the income, and in going up would destroy the light and air of some of the earlier buildings that had been put up. That created the condition that the owners of these lots who had small buildings were strongly against passing a zoning ordinance unless their taxes and land values were reduced. That is a question I wish Mr. Corbett would tell us how we can deal with by getting some sort of an Enabling Act so that the taxes would be reduced. In some places we are in very bad shape.

Mr. Corbett: In New York, where the property values are such that it would have been manifestly unfair to limit the height of buildings reasonably, the zoning commission permits a height of 2½ times the width of the street. Now, that may not be up to the point of bringing the returns with it that it should, but it seems to me that under conditions of that kind, zoning a city so that real property values are very high, you may allow an extra height. If that does not meet the situation it seems to me that the city might relieve the owners from taxation in those particular sections. I do not see any other possibility.

A delegate from the Michigan Chapter: Woodward avenue, our main thoroughfare, is 150 feet wide. We set out to allow 100 feet in height, and after taking it up with the property owners, they wanted 250 feet. I am afraid that unless the valuation and taxes are reduced, they must have about 300 feet in order to allow them to get any return.

Mr. Corbett: You see, this law as we have it in New York does not restrict the height to 250 feet. That is only the front wall of the building. Then we go up at a line drawn from the center of the street. That permits a great many stories.

Delegate from the Michigan Chapter: That would work very nicely in other places but Detroit, as it happens, is laid out with many lots 30 feet wide and 250 feet deep.

Mr. Corbett: Then I would suggest to your prop-

erty owners that they unite and throw several of these properties together.

Mr. Gray: I think one of the interesting features of this zoning ordinance is that it is doing the same thing that cooperative housing is doing. It tends to induce people to think in terms of larger units. As Mr. Corbett has stated, that is the only way out. They have got to throw their parcels together and think in terms of larger units, which we all recognize is a very desirable thing.

One more statement I would like to make. In Connecticut we have before the Legislature at the present time a State Enabling Act which was drawn up with very great care in conjunction with the best advice that could be had from people who have had experience with zoning in the various cities all over the country. We have consulted all the people who have actually been working with the law, the architects and the lawyers, and we have a draft which the people in New York, who have had most experience and who have been advising other people over the country, say is the best state act which has yet been produced. I would suggest to Chapters wishing to start a zoning movement in their state, that if they will write to the New Haven Chamber of Commerce for a copy of that act on state zoning, they will undoubtedly receive it, with a brief describing the action of the law.

Mr. Coolidge, of Boston: Mr. Fenner's remark that the New York law was not all that they would like it to be, but was perhaps the best they could get, moves me to point out that one of the dangers in legislation about zoning is that of overlooking the street capacity to which the legislation should apply. I trust Mr. Fenner will correct me if I am mistaken, but I feel pretty sure that in designing the lower limits of height for New York, he had in mind the danger of overtaxing the street capacity, even of New York.

In Boston, where we have long had a limit of 125 feet, or the utmost of $2\frac{1}{2}$ times the width of a street for streets less than 50 feet wide, we are quite convinced that if our downtown sections today were solidly built up to the height that the law allows, our street capacity would be entirely inadequate to take care of the traffic thereby created. In other cities I have noticed that with the great increase in parking space required or desired for automobiles, the street capacity is actually less than it was when buildings were lower. Therefore, in dealing with the problem of zoning, I think it is quite important to establish some ratio between the amount of occupation per acre for buildings, especially in a business section, that is compatible with the area that is allowed for streets and sidewalks.

Mr. Litchfield, of New York: Before the appointment of the zoning committee in the City of New York there was a building commission which attempted to tackle the same problem, and they made a

report to the Board of Aldermen setting forth a principle which, while it was not stated by the zoning committee, is really the basis of the legislation; and, as it is a principle which applies to all cities, it may be worth while for me to state it. That building code commission stated that instead of setting a flat limit of height, which was the advanced legislation suggested at that time, that the proper procedure was to set a limit of volume; and really, that is the thing for all zoning commissions to bear in mind, that they should determine the volume of the building permitted to grow upon a lot in any section. In other words, the law as prepared by that commission said



FIG. 10. FRONT VIEW OF WURLITZER AND BUSH BUILDINGS, WEST FORTY-SECOND STREET, NEW YORK

that there should be no building built in certain sections of New York the volume of which should be more than 174 times the area of the lot.

You can see how that principle works. There is no objection to height of buildings, per se. The objection to the high building has been that it has robbed the light from the street and from its neighbors, and has overtaxed the street's transportation and sewer facilities, so that, if the principle be borne in mind that for a certain section one factor is appropriate and for some more densely populated sections another factor is appropriate, it will be more practicable to work out your ideal law.

AN IMPRESSION of the WASHINGTON CONVENTION

Mr. Howard Van Doren Shaw, of Chicago, Reports as a Delegate to the Recent Washington Convention

YOUR delegation filled about six per cent. of the chairs in the Convention; but we occupied about fifty per cent. of the floor. I say "we"; but figuratively I only held the coats of the gladiators when they went to it. I fear I am a hopeless failure as a delegate. I never changed a by-law in my life. In fact, I did not know anybody ever read constitutions, canons and by-laws—I thought of them as one does of foundations which one cannot see but hopes are there. And yet it seems the greater part of three days is spent in the exciting business "of striking out that part of section 122, paragraph 3, after the words, 'client' and inserting, etc., etc.," Most of the changes are prefaced "for the protection of the client or public." I suppose this bunk is due to the proximity of the convention hall to our National Congress.

The canons themselves seem to be for the encouragement of honesty among the architects. If a dissatisfied owner wants to get rid of an architect, or an unprincipled confrere tries to get a job away from you, Canons of ethics are not likely to help you. You will need a sawed-off shot gun. You cannot legislate a gentleman. It reminds one of the alchemists of old who spent their lives trying by weird incantations to turn the baser metals into gold.

Personally I like to think of the Institute as a time-honored old guild of which Ictinus, Bramante, Brunelleschi, Christopher Wren, Bulfinch, and many other masters are among the early members, and where today, one meets the men who are making this a better looking world and discusses architecture, *not* by-laws. I would like to have the canons graved on old lichen-covered marble. They could be very brief, about like this: "Be a gentleman, if you can; but for God's sake be an architect." Time and nature dignify any creed, just as they do any structure; but nowadays we cannot let constitutions alone; Vide the 18th Amendment. Randolph Coolidge made a long address, telling what a marvelously perfect document the Institute's Competition Code was and he proposed adding a Boston bay window on this Parthenon. I was born a blue Presbyterian; you know this church hasn't much ecclesiastical setting and a few years ago, some progressive pillars of the church decided they could not stand for "infant

damnation," so they coolly changed the creed, the only thing about the church that dated back of the last cranberry crop! And I'll bet the little infants laughed in their sleeves! You may not believe Jonah's early trip in the submarine; but surely you would not cut this quaint bit of decoration out of the King James Version.

Had Michael Angelo and Palladio and the rest of them spent their time worrying over a minimum charge, where would the Renaissance have come in? Athens could well have paid Ictinus 100 per cent. commission for the Parthenon. It is about the only thing which has kept modern Greece from sliding off the map.

There are notable architects at these conventions (there would be more if you would emphasize architecture and corral this business), men whose work will go down in history. Why not let them talk of their art and leave the business end to the Board of Directors? Think of a walk about London with Christopher Wren, pointing out his many towers and telling his hopes and dreams of others.

In Washington we might go over the superb Lincoln Memorial with Henry Bacon, The Freer Gallery with Charles Platt, the new Treasury with Gilbert, or the Hitt House with Pope. Klaudee's talk and plans of college yards; Howe's fascinating views and clear drawn plans of French Farms were the only efforts in this line at this meeting, and are, I understand a new departure.

The exhibition of contemporary work at the recent conventions is a splendid move in the right direction.

Possibly a drastic reduction in the size of the delegations would expedite business; but there should be a corresponding encouragement to members to attend for the inspiration of meeting fellow architects and seeing their work, would mean real education. The allotted span of life of seventy years is not very long if the first twenty-five are spent getting ready and the last fifteen playing golf. It leaves only about thirty years to help make this a better looking world than we found it. Let us not spend it changing by-laws.

To all of which the editors of THE AMERICAN ARCHITECT add a fervent "Amen."

DEPARTMENT OF ARCHITECTURAL ENGINEERING

A CONCRETE COAL BIN of UNUSUAL DESIGN and CONSTRUCTION

THE uncertain elements that enter into the construction of engineering works must be considered when the designs are made. Engineers realize the limits of their control over the actual work in the field and for that reason they often refrain from designing in unusual ways, especially when high stresses are involved. This does not apply as much to designing in structural steel as it does to designing in reinforced concrete. The manufacturing of the steel and its fabrication are done in the shop under the best conditions and its erection in the field is easily inspected. In the construction of reinforced concrete work, while the design may be perfect and

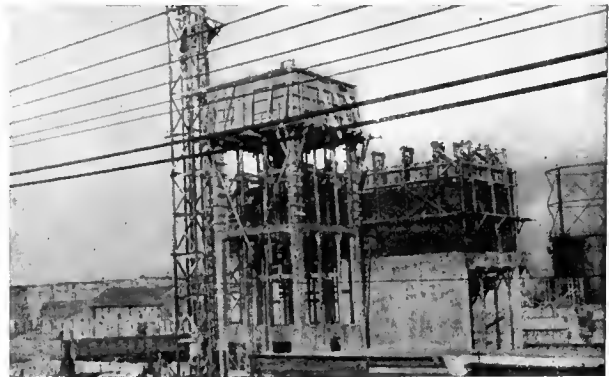

COKE QUENCHING PLANT DURING CONSTRUCTION

contractor for their construction. Under these circumstances, he designed in a way that others might refrain from doing for reasons stated above. The undertaking, in design and construction, was successful.

This coal bin serves to load the Lorry cars used



COAL MIXING AND PULVERIZING PLANT, SHOWING STEEL LOADING TRESTLE

the materials of the right quality, the making of the forms, the placing of the steel and the mixing and placing of the concrete are all field work done largely by unskilled men. When all of these points are taken into consideration, it will be apparent why the coal bin here described and illustrated is considered to be of "unusual design." This coal bin and the other concrete structures were built for the St. Louis Coke and Chemical Company at Granite City, Ill. Mr. L. J. Mensch, M. Am. Soc. C. E., of Chicago, designed these structures and in addition was the

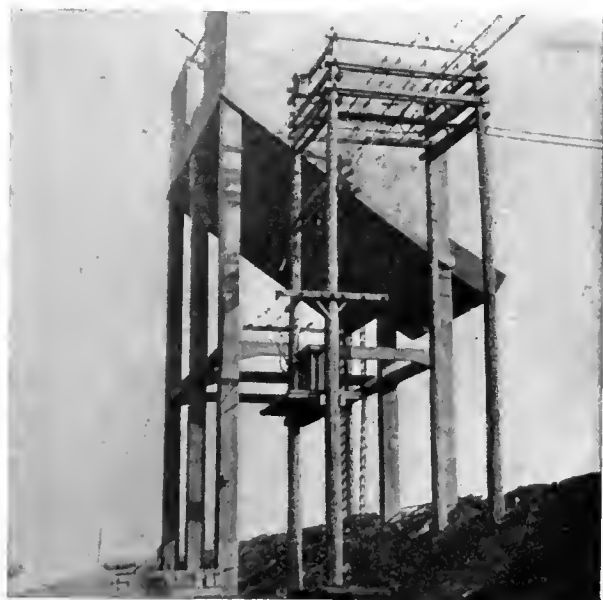

COKE LOADING PLANT

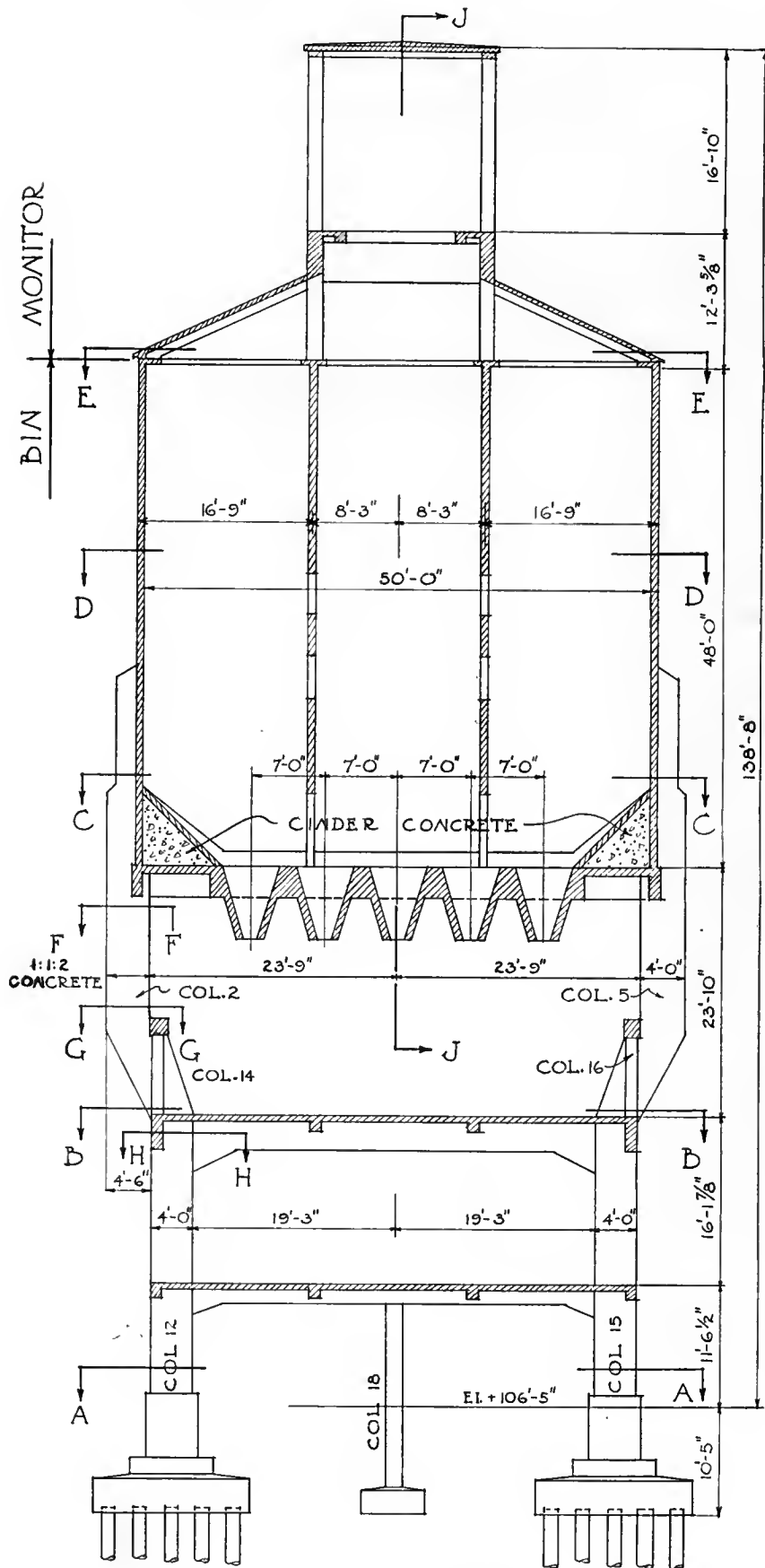

CROSS SECTION
SHOWING CENTER WALL BETWEEN BINS

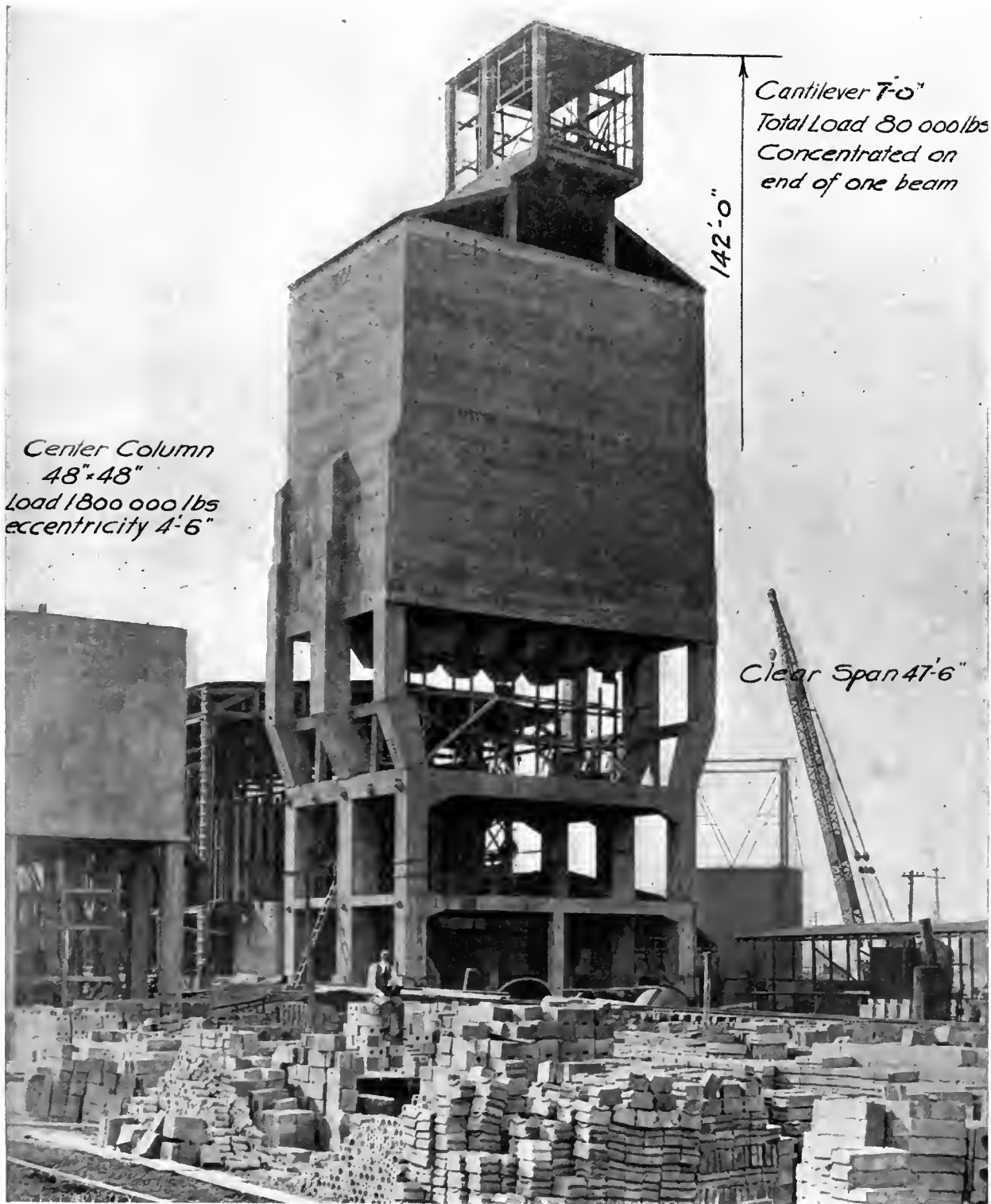

*Center Column
48" x 48"
Load 1,800,000 lbs
eccentricity 4'-6"*

*Cantilever 7'-0"
Total Load 80,000 lbs
Concentrated on
end of one beam*

142'-0"

Clear Span 47'-6"

COAL BIN FOR ST. LOUIS COKE & CHEMICAL CO., GRANITE CITY, ILL.
L. J. MENSCH, ENGINEER

in charging the coke ovens. These cars are attached to a traveling crane and are loaded below openings in the bottom of the bin. The spacing of the Lorry cars and the charging openings in the ovens are such that the width of the bin is fixed and requires a clearance of 47 ft. 6 in. beneath it. The pushers used for removing the hot coke from the ovens must pass the bin at a lower elevation and require an overall width of 46 ft. 6 in. between the outside faces of the columns. For this reason the larger columns at the center of each side of the bin are offset 4 ft. 6 in.

The capacity of the bin is 1,900 tons of pulverized coal, which affords storage capacity for nearly four hours' use as the Lorry cars have a removal capacity of 500 tons per hour. The bin is charged through the monitor which adds quite materially to the total load.

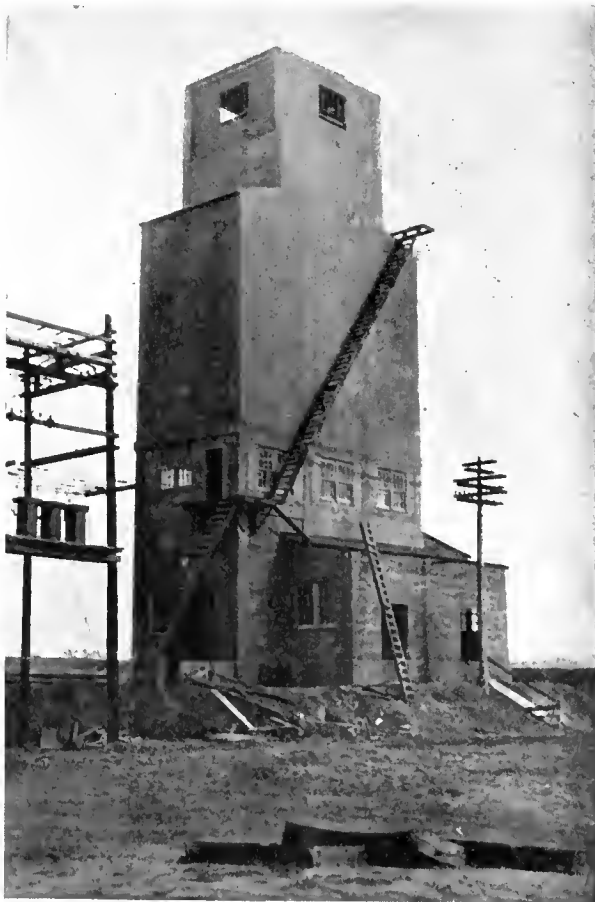

COAL MIXING AND PULVERIZING PLANT
DURING CONSTRUCTION

The bin portion of the structure is 32 ft. 8 in. by 50 ft. in size and 48 ft. high. The bin is divided into six cells by partitions. Those partitions connecting opposite columns are designed as beams with flange at top and bottom as shown in Section J J, and thus serve to transmit the load to the columns. Two longitudinal partitions are provided at the third points in the span and serve to act as stiffeners to the transverse walls to prevent buckling and to tie in



BLAST FURNACE CHIMNEY

the outer walls. These partitions have a large opening at the bottom and four small openings above, which facilitate the flow of the pulverized coal to the outlets in the floor. This division of the bin serves to bring the moments of the horizontal pressures on the walls down to reasonable amounts so that light walls will have sufficient strength. As the greater part of the load is applied to the cross-walls near the bottom, vertical bars are provided to distribute the stress over the entire cross-section of the wall. These vertical rods diminish in size toward the top and are furnished in convenient lengths for handling. All rods are hooked on the ends and ample laps are provided at the splices.



PIG IRON LOADING PLANT

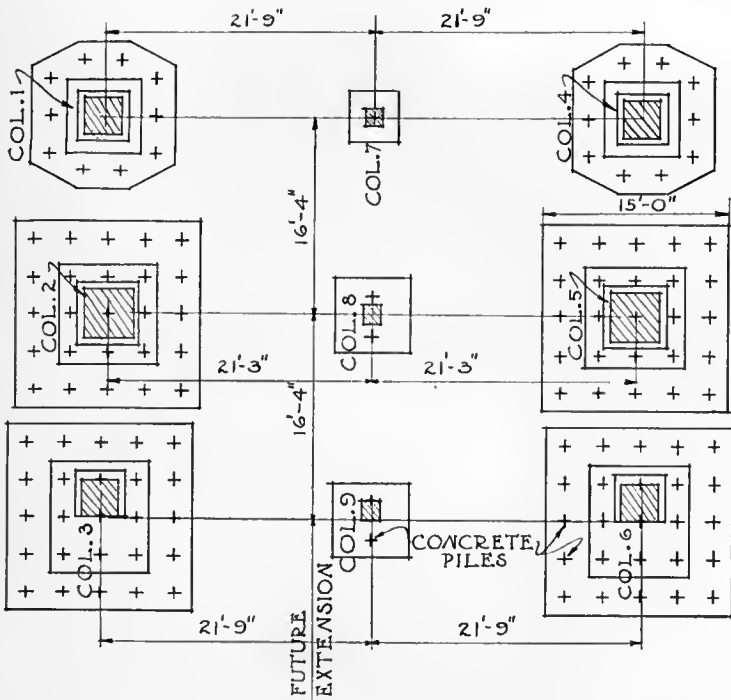

SECTION A-A. FOOTING PLAN

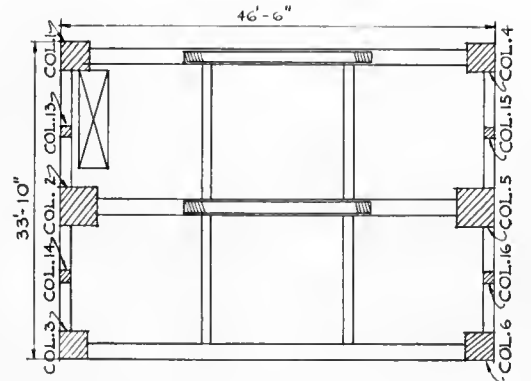

SECTION B-B. PLAN OF SECOND FLOOR

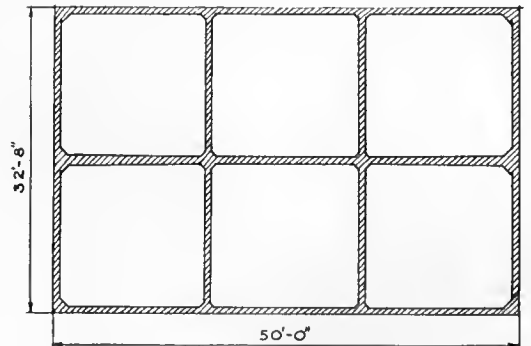

SECTION D-D. HORIZONTAL SECTION THROUGH BIN WALLS

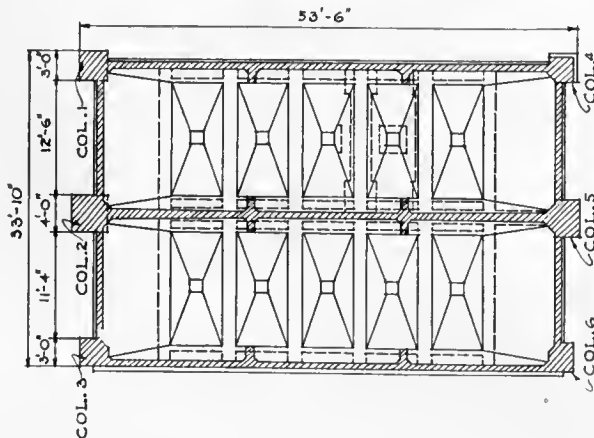

SECTION G-G. FLOOR OF BIN, SHOWING HOPPERS

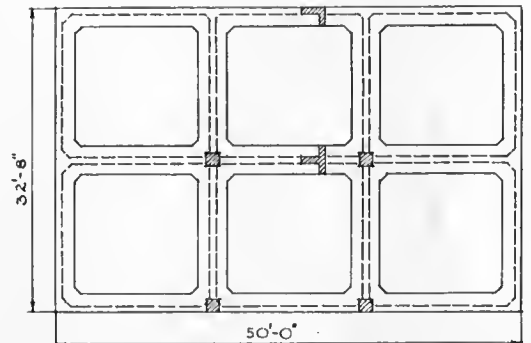

SECTION E-E. PLAN OF TOP OF BIN WALLS

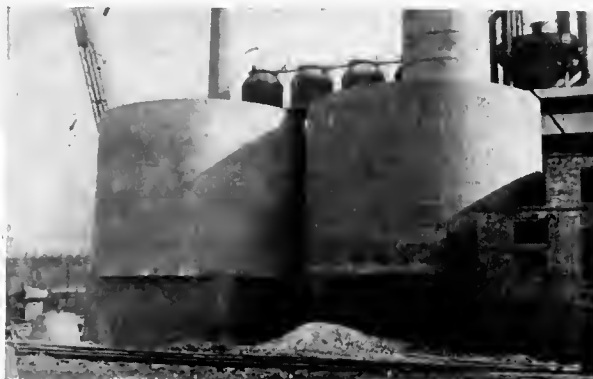

WATER PURIFYING TANKS

The columns 2 and 5 support the maximum load of 1,800,000 lbs. and have an eccentricity of 4 ft. 6 in. They are 48 in. square and made of 1:1:2 concrete. The principal reinforcing consists of twenty $\frac{1}{4}$ in. square rods and a $\frac{5}{8}$ in. round spiral having a $1\frac{1}{2}$ in. pitch. On the tension side at the critical points, there is placed additional reinforcement con-

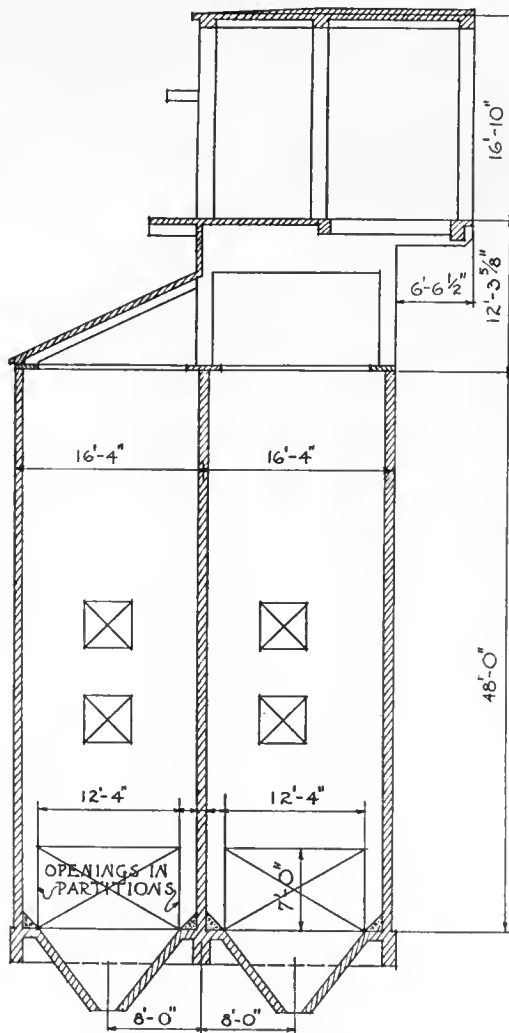

SECTION J-J
LONGITUDINAL SECTION



sisting of ten $\frac{1}{4}$ in. square rods. At the point of bend the compression side has two small additional spirals made of $\frac{5}{16}$ in. round wire with $1\frac{1}{2}$ in. pitch and placed in the corners outside the main spiral. The six columns on the sides of the bin extend up above the bottom of the bin about 20 ft. with the appearance of buttresses and thus take the



COKE QUENCHING PLANT

load transmitted through the deep cross-wall beams. The foundations for columns 3 and 6 are made to support two more columns of similar size and loading which will form a part of an additional bin of the same size. The foundations rest on pre-cast reinforced concrete piles.

The chimneys are built of reinforced concrete and are 250 ft. high. The outer wall is 12 in. thick at the bottom and 5 in. thick at the top. The walls taper towards the top and the upper 30 feet have no taper. They are very well proportioned and graceful in appearance. The chimneys are lined with a 4 in. wall of firebrick throughout the entire height. At 50 ft. intervals a concrete shelf is built on the inside of the stack on which rests the lining. The blast furnace chimney has a minimum inside diameter of 7 ft.; the two coke oven chimneys have a minimum inside diameter of 9 ft. and the power house chimney one of 13 ft. 6 in.

The boiler feed water is purified in two circular reinforced concrete tanks in which is installed a mechanical agitator. A reinforced concrete trestle was built on which the pig iron is transported to a loading platform; a reinforced coke loading plant was constructed which is supplied by apparatus supported by structural steel frame and not shown in the illustration. A reinforced coal storage, mixing, crushing and pulverizing building was constructed and is

THE AMERICAN ARCHITECT

supplied with coal by means of a structural trestle. A coke quenching plant was built of reinforced concrete. This consists of a gravity water tank, cooling water basins or reservoirs and an elevated structure made up of four walls which confine the spray and steam which arise from the flooding of the cars filled with hot coke.

Every part of the reinforced concrete construction in this plant is of interest to the engineer and includes almost every problem found in engineering construction. These structures were originally designed for the use of structural steel. Mr. Mensch submitted alternate designs and bids for concrete construction which were accepted, resulting in considerable saving in time and cost.

A New Way to Lay Brick

THE so-called "Ideal" brick wall is attracting much attention, and bids fair to become a widely used method, according to reports from men who have actually tried it out.

There are two types of the "Ideal" wall, one type being constructed with all the brick laid on edge, the other type being with the outside four inch thickness laid flat in the ordinary manner. The wall is particularly adapted to residence building and is an economical type for garages and all small structures having an ordinary floor load.

No special shapes or sizes of brick are required. It may be constructed with either face brick, common brick or combinations of the two, the standard size of either being $2\frac{1}{4}$ by $3\frac{3}{4}$ by 8 inches. It is recommended that the twelve inch wall be used for the basement and the eight inch wall for the remaining walls.

It is widely advertised that the new form of wall cuts from 25 to 35 per cent. of the cost of construction and produces a better ventilated wall and one having a very ample margin of safety for the residence class of construction.

A National Building Code

A STANDARD building code, which may be taken as a pattern by cities and which will promote the standardization of building methods and requirements throughout the country, will be undertaken by the Department of Commerce. This forecast comes from a most reliable source in Washington, D. C., with the further information that Franklin T. Miller, who has served as the assistant to the Senate Committee investigating the construction industry, may be asked to take charge of the work.

Oxy-Acetylene Used in Breaking Up Concrete

IN a building under construction in Cleveland, Ohio, considerable concrete work was put in through error. It was found necessary to remove the misplaced structure, and a crew of laborers as-

signed to the task attacked the concrete with sledges and drills. At the end of three days the progress made was so small that other and more rapid means of removal became imperative.

A demonstration proved the feasibility of speeding up the work with the oxy-acetylene torch.

The method employed consisted of heating along the line of the desired fracture with an ordinary welding torch, using a long bushy flame. The concrete was not raised to a great heat, as measured in terms of oxy-acetylene, but the heat was confined as much as possible along the proposed line of fracture. When so heated the concrete yielded to a heavy blow of the sledge, breaking off in the predetermined form and bulk.

This is not a new application of the oxy-acetylene torch, but, as it is a bit outside of its ordinary field, which is essentially the welding and cutting of metals, it is well to keep it in mind for emergency cases of the type noted. There are doubtless many other places where the torch might be advantageously applied in wrecking concrete.

Power Test Codes Are Being Framed

NINETEEN power test codes, constituting what their framers style a "national common law," in the field of power plant testing, are being framed by 125 leading engineers, scientists and educators under the auspices of the American Society of Mechanical Engineers.

The codes, when completed, will affect a wide range of industrial enterprises, large and small. They will provide courses of procedure by which everything from an electrical superstation to a boiler feed pump shall be tested to see if they comply with the terms of purchase or if they are operating at the desired efficiency.

The committeemen represent engineering societies, manufacturers, public service corporations, national, technical and scientific associations, railroads and government agencies, including the Bureau of Standards and the U. S. Naval Academy.

What was one of the most important public hearings and discussions held by engineers took place in Chicago during the sessions of the spring meeting of the American Society of Mechanical Engineers, May 23-26. Three codes were presented to the A. S. M. E. for consideration and adoption at this session.

Professional Society Organized in Spain

ENGINEERS of Catalonia, Spain, have organized a professional society similar to the American Association of Engineers, under the title, General Technical Society of Catalonia. According to a statement in its introductory bulletin, just issued, the society is organized for cultivation of the common interests of engineers, for participation in bringing about a solution of the "social struggle of our times."

THE AMERICAN ARCHITECT

for contributing to the settlement of the conflict between employing and laboring classes, and for upholding the profession of engineering in public life. Manuel Vidal is president, Alejandro Hommedieu is secretary, and Manuel Escude is corresponding secretary. The addresses of the two latter are Calle San Salvador 61, and Calle Laforja 12, Barcelona.

University of Colorado Course in Municipal Design

A COURSE in municipal design, embracing the town plan, streets, water supply and sewer system, is being given in the senior year of the course in civil engineering at the University of Colorado.

J. B. Marcellus, associate professor of civil engineering, is in immediate charge of the course.

Pennsylvania May Tax Cement

IT is announced from Harrisburgh Pa., that the legislative committee in search of new sources of revenue may tax cement production at its source. It is reported that a tax so placed would bring into the state about \$2,000,000 a year. Already in the draft of the bill are taxes on minerals, lumber, oil and gas.

Dust Explosion Hazards in Designing Buildings

MR. DAVID J. PRICE, engineer in charge Grain Dust Explosion Investigations of the United States Department of Agriculture, Bureau of Chemistry, gave a talk before the Western Society of Engineers, Chicago, Ill., on March 28, 1921. His talk entitled "Dust Explosions" was printed in full in the May, 1921, Journal of the society.

An interesting fact of value to architects, given by Mr. Price, is that "there is not a type of electric lamp made but that when the bulb is broken will produce dust explosions immediately if there is the proper proportion of dust in the air." This means that the use of unprotected electric bulbs in dusty atmospheres is unsafe. A mere wire guard is insufficient; the covering must be vapor proof. The investigation also showed that dust settling on bulbs may be heated to incandescence and lead to resulting fires and explosions.

Proper designing against dust hazards requires electric lamp bulbs to be properly protected, proper control of static electric conditions in certain types of milling machines, proper systems for controlling dust deposits and approved methods for collecting dust. Verily, the modern planner and designer of buildings must be up and doing to keep track of de-

velopments. A building is no longer merely a structure having walls and roof; it is clock full of temperament to a degree rivalling a petted stage favorite.

Building Cost Estimates

MR. BARCLAY WHITE, a Philadelphia builder, gave the following weighted estimates of component costs of buildings at the February, 1921, Philadelphia Conference on the Construction Industries.

He assumed a composite building in the Philadelphia territory, consisting of a reinforced concrete factory building; slow-burning or heavy construction warehouse with brick walls; typical two-story dwelling; detached brick and frame residence; stone school house with wood floor construction; fire-proof institutional building; an apartment house; a steel frame office building. From his own records of costs he selected a typical instance in each of the eight types, divided it according to actual costs into labor and materials and weighted these costs according to the volume of each of these classes in the territory.

The total for all skilled labor, which includes stone cutting, shop work on stairs, mill work and sheet metal aggregates 27.55 per cent. on the total cost to the owner. Unskilled labor amounts to 9.44 per cent., general supervision, engineering and estimating 5.60 per cent. and liability insurance is 1.41 per cent., bringing the total direct building labor cost to 44.0 per cent. of the completed building.

Materials cost as follows: lumber, 8.86 per cent.; brick delivered on site, 6.10 per cent.; structural steel fabricated in shop and delivered on site, 5.93 per cent.; boilers, piping, etc., on site, 5.81 per cent.; cement, f. o. b. cars Philadelphia, 2.60 per cent.; hardware and nails, 1.78 per cent.; sand delivered, 1.69 per cent.; all electrical fixtures and materials, 1.60 per cent.; stone for concrete, etc., 1.49 per cent.; all other materials, 7.02 per cent.; making the total for materials 42.88 per cent., or a little less than the direct building labor costs.

Office rent, general expenses and overhead, but not including office wages, amount to 5.80 per cent. Sub-contractors' net compensation is 3.90 per cent. and net compensation of general contractor is 3.42 per cent. It is assumed that sub-contractors do about 65 per cent. of the work; the general contractor does about 35 per cent., and, in addition, directs and supervises the balance.

STATE SOCIETIES

Extracts from a Paper Presented to the Fifty-Fourth Annual Convention of The American Institute of Architects by Delegates from Four Societies in Western States

THE delegates representing the State associations of architects from Illinois, Michigan, Indiana and Idaho, who were invited as your guests at this convention, desire to express their appreciation of this opportunity of meeting with you and desire at this time to make clear their united opinion regarding mutual affairs.

We believe there is great need for all architectural societies to co-operate in upholding a high standard of architectural practice. We recognize the American Institute of Architects as the society "par excellence." We concur with your board that it would not be wise at this time to do anything more than establish "a flexible point of contact" between our respective organizations.

The State societies are, however, seeking and earnestly desire closer co-operation. The State societies, due to their simpler form of organization, have a wonderful opportunity of uniting for good of the profession a large coterie of men who otherwise would be standing alone.

The code of ethics adopted by these societies is modeled after that of the Institute and there truly is an earnest effort being made on the part of its members to fully live up to these high standards. The records of these State societies show strict discipline over their members which tends to produce a closer observance of the code of ethics than would be otherwise.

THE State societies being organized primarily to look after the business end of the profession can and do relieve the Institute chapters of much of this work, so that they can, if they so desire, devote more of their own energies to the ethics of the profession, as was their early practice.

That a closer co-operation may be had we respectfully suggest that the Institute appoint a standing committee on State societies, said committee to be composed of four members who are also members of some State architectural society, and that each State society be requested to form a like committee on American Institute, which said committee shall have at least one architect who is a member of the Institute. It is obvious that the duties of these several committees would be to keep fully posted by correspondence or otherwise as to objects where both the Institute and the society could be of mutual assistance, and to do their utmost to bring about the desired co-operation.

It is sympathetic and practical co-operation we are seeking, and we urge this convention to give these matters its earnest consideration.

We believe that the organization of the National Council of Architectural Registration Boards will prove a tremendous power for the profession at large, and being composed of architects who are members of the several State examining boards, they will be and undoubtedly are the leading powers to accomplish that much desired proposition of having high grade uniform license or registration laws with uniform standards for examinations.

Here at least is one illustration where full co-operation on the part of all would be practicable and desirable. When the committees above referred to shall have become a working factor, surely better understanding and co-operation, obtaining greater results will be our mutual reward. We also believe it wise to bend our efforts in conjunction with the Institute in bringing about a condition in all the States such as will permit of a model registration law—to that end we pledge ourselves and our State societies to co-operate with the Institute in having a comprehensive building code adopted in our States as soon as feasible, so as to make it possible to have enacted a law which will protect the use of the title "Architect." When this millennium arrives the engineers and architects will be the best of friends, and all jealousies and animosities buried forever. May we not ask the Institute actively to push this problem for the coming year?

May we also suggest that it is our opinion that it would prove mutually beneficial if the 2,000 members of the State societies could receive the Institute Journal at the same price sold to your own members?

INDIANA STATE SOCIETY,
By Herbert W. Foltz.

ILLINOIS SOCIETY OF ARCHITECTS,
By H. B. Wheelock.

IDAHO SOCIETY OF ARCHITECTS,
By Burton E. Morse.

MICHIGAN SOCIETY OF ARCHITECTS,
By W. G. Malcolmson.

Architects' "House Organ" Issued

THE Washington State Chapter of the American Institute of Architects has inaugurated the issuance of a monthly bulletin. The bulletin is intended to be a "house organ," devoted to the activities of the A. I. A. and its members, and will be circulated among the A. I. A. members throughout the State of Washington.

THE AMERICAN ARCHITECT

English Architects Meet

THE recent meeting of the Architectural Association in London was pervaded with a sense of dominating personality rather than any quality of serious discussion, an atmosphere of ideas, ideals and great enterprise.

Mr. H. Gordon Selfridge, whose subject was announced as "Architecture in Commerce," did not lecture, but spoke generally of many things, of the duty to the State of commercial men, the influence of fine work on the people, of tradition, taste, "correctness" and such-like—all great sounding phrases and words—the food upon which the architect is reared, but coming from a commercial magnate such words carried an unusual weight.

Many valuable thoughts were brought to mind, not all new ones, but which, being familiar, are often overlooked.

Mr. Selfridge apparently sees beauty in horizontality and discerns no "charm of proportion" in the skyscrapers of his country.

He spoke eloquently of the influence of fine work, and instanced the benefit derived by the many thousands of people who passed daily through the great stations of New York.

The vexed question of the "Public"—about whose taste the architect so frequently complains—was seen from a different angle. The success of a great business depends, to an appreciable extent, upon the thorough and sympathetic understanding of its patrons and the "up-to-dateness" of its organization.

Considered action with a definite policy soon convinces the public, and the advertising experts to great enterprises have understood and made use of this, to the enlightenment of the public and betterment of their concerns. Mr. Selfridge suggested that perhaps architects might adopt a similar policy. Create a sort of professional "Calisthenes" to drum and keep on drumming into the public the truths of architecture till in time it will believe them: architecture explained popularly and with "punch"! The public may not know now, but then no one has told it!

Perhaps architects do not quite see their art in this light, but there is something to be said for the much abused "public."

The plate-glass "bogey" was, of course, in evidence. Why should this always lead to so much discussion between architects and men of business? There appears to be sometimes too great a desire for glass on the part of the shopkeeper, and too strong a craving for "columns" on the part of the architect, but it is surely a question of adjustment of values and a better understanding of conditions.

Shops are not all of one kind; and in the same way that the patrons of one store differ from those of another so the quality of the wares will differ and consequently the requirements vary. The store with the choicest wares does not confuse one with another by "piling" them behind vast stretches of glass, but

by carefully framing each piece or group of pieces creates a contrast which enhances the beauty of the wares. With such a store the architect's problem is comparatively easy. But there is a much more difficult one in the case of the store where the policy is to show as much as possible to the passing crowd, where glass is all important, and the shopkeeper is not entirely to blame if the architect sometimes, against his better judgment, allows great "architectural" lumps of stone to be used over plate glass with no apparent support. Fortunately, however, this policy appears to be receiving modification in our large stores. The value of a great architectural treatment to the shopkeeper is great, it forms a suitable setting to his wares. By its distinctive character it is recognized and talked about, while it is a means of advertisement it is also an embellishment to the city.

A factor which has greatly influenced the development of stores in recent years is the necessity for much more serious consideration for the welfare of the employees. It is recognized that the success of the undertaking is largely due to the efforts of the staff and much is done to foster their interest in the work until it becomes vital to them, until, as Mr. Selfridge said, "they would come in the morning without regret and leave at night, at least, not with a sigh of relief."

The meeting was a spirited one and Mr. Selfridge was recognized as a great enthusiast, and enthusiasts, whatever their creed, are always welcome to the Architectural Association.

Industrial Teachers' Scholarships in New York

THE University of the State of New York is offering twenty-five scholarships to qualified trade and technically trained persons who desire to prepare themselves for teaching. Persons selected to hold these scholarships who satisfactorily complete the prescribed one year resident industrial teacher training course are licensed for life to teach their specific occupations in the vocational schools of the State. The salaries paid vocational teachers now range from \$1,800 to \$3,500 per annum.

Each holder of the scholarship will receive at least \$1,000 for the period of one school year. This amount is paid in ten equal installments. Holders will be required to be in attendance for ten months in the Industrial Teacher Training Department of the State Normal School at Buffalo.

Applicants for appointment to the industrial teachers' scholarship must possess the following qualifications:

1. *Trade, industrial or technical experience.* At least five years of successful all-round experience in work of not less than journeyman's grade in some trade, industrial or technical occupation.
2. *Education.* A good general education and ability to speak, read and write the English language.

THE AMERICAN ARCHITECT

3. *Age.* Not less than twenty-one or more than thirty-six years of age on August first of the year in which the appointment is made.

4. *Health and character.* Of good moral character and in possession of good health.

5. *Citizenship and residence.* A citizen of the United States and a resident for one year of the State of New York.

On the basis of the qualifications of the candidates a merit list will be set up for each trade, industrial or technical occupation. There will be no formal examination but candidates will be rated by examining committees as to general education, practical experience, loyalty, moral character and physical fitness. Candidates may be required to appear before the examining committees for a personal interview.

The twenty-five scholarships will be awarded to qualified persons with all-round experience in the following occupations:

Electrical construction, repairing and operating. Machine shop work. Automobile repairing. Machine drafting and designing. Architectural drafting and designing. Sheet metal working. Printing, including presswork and composition. Bricklaying. Painting and decorating. Carpentry.

Detailed information and blanks upon which applications for scholarships may be made should be secured very promptly. The Director of Vocational and Extension Education, State Department of Education, Albany, N. Y., will furnish this material and information upon request.

Paris to Have Mosque

THE city of Paris is soon to have its first mosque for the benefit of the Mohammedans in French possessions in northern Africa, Algeria, Tunisia and Morocco. The people of those colonies have subscribed to a fund for the erection of the building and Algeria has nominated an iman, or leader for the mosque.

Two Small Books Which Interestingly Illustrate Designs by Batty Langley

PROBABLY no architectural author was more prolific than Batty Langley and no man has had greater influence on his contemporaries and successors. The large volume of his drawings makes it difficult to believe that one man could accomplish so much in a lifetime. Born in 1696, he lived for but fifty-five years. He was thirty years old when he published his first work, so that in the quarter century which followed must be placed the voluminous series of drawings of which he was the author.

Two small books, $4\frac{1}{2} \times 5\frac{1}{2}$ inches, published by John Tiranti & Co., London, and sold in this country by the U. P. C. Book Co., 243 West 39th Street, New York City, have been issued, containing in a reduced form copies of important plates by Langley. One is called "The Builder's Jewel," the other

"A Treasury of Designs." These are somewhat remarkable by reason of the clearness of the reproduced plates, and there can be no question as to their educational value not only to architectural students, but also to the man in practice.

Plan Burroughs Memorial

PLANS are under way for the formation of a John Burroughs memorial association to take charge of Slabsides, Riverby and Woodchuck Lodge—the three places most frequented by the poet-naturalist who died recently.

The plan has already been approved, and a committee chosen to take charge of the work.

Two Churches Under Reims

Ruins of Fifth and Ninth Century Structures Found Beneath Cathedral

THE ruin of Reims cathedral has brought to light the buried remains of its predecessors, states *The Living Age*.

Under the pavement of the choir, which was broken into fragments by German shells, workmen found the old foundations which had once supported the noble cathedral of Saint Hincmar, burned down in the ninth century. Delving lower still, they came upon traces of the first church to stand on this hallowed ground, that of Saint Remi, missionary bishop of the early church, who baptized Clovis, the first Christian king of France, early in the fifth century.

Under the broken high altar they found 250 ancient pieces of silver and—what is even more precious—a long sealed well, with water still at the bottom. From this well turns a conduit in worn lead piping, from the direction of what it is now possible to place with certainty the long vanished baptismal font where Clovis was received into the church.

A Proposed Erection of Permanent State Buildings in Washington, D. C.

THE project looking to the erection in Washington of state buildings by all of the 48 states, to house permanent exhibits and serve as headquarters for visitors, is one which if fairly begun would grow fast. At all the expositions held in recent years the various states constructed buildings which held exhibits of their products and resources. Thus, while advertising the advantages of the states, they also served as headquarters for visitors from the respective states. The proposal now under consideration is along the same line, except that it contemplates the erection of permanent instead of temporary buildings.

Hundreds of thousands of visitors come to Washington every year, and if each state had its own building here every man, woman and child would take pride in registering in his own state building and thus identifying himself with his own home.

The proper place to locate these buildings would have to be determined by the commission of fine

THE AMERICAN ARCHITECT

arts or some other body qualified to preserve the artistic beauty of the city. There is, however, plenty of space available for the purpose and there would be little trouble in having Congress make provision for the necessary sites.

Once the project is under way and one or two of the larger states have appropriated the money for state buildings here other states would follow suit, for local pride would be sufficient incentive to induce them to co-operate. Intelligent and energetic work is all that is needed to give the plan the necessary impetus.

Ancient Stone Plaque

A STONE plaque which is believed to be about six thousand years old has recently been unearthed at Graig-lwyd, Penmaenmawr, Wales. The engraving was done in Neolithic times, probably by men of the Iberian race; triangular symbols form the pattern. The plaque is now in the Royal Institute of Anthropology at London.

Rotch Scholarship Award

THE Boston Society of Architects recently awarded the Rotch Traveling Scholarship to Frank S. Carson, of Boston. The second award went to Victor L. S. Saffner.

Michigan Chapter, A. I. A.

ON the evening of May 25, Harvey W. Corbett, of Helmle & Corbett, architects, addressed the members of the Michigan Chapter of the American Institute of Architects in Detroit on "High Buildings in Relation to Narrow Streets." Early in the afternoon he also spoke to the students of the College of Agriculture at the University of Michigan.

In April, Frederick L. Ackerman, A.I.A., spoke to the Chapter and to the students of the university on "Building Conditions."

The profession at large and students have much to gain from the willingness of architects to take time away from their offices to give such lectures. It is a form of service which, while involving no compensation, is of great value.

Unearth Thessalian Temple

ACCORDING to press reports, Greek Archaeologists have unearthed an imposing temple at Rerras, Thessaly. The structure is in an excellent state of preservation and is stated to be as large as the Temple of Jupiter at Olympia. The bronze inscriptions establish the date as 400 years B. C. Numerous tablets have also been found bearing indications of laws and resolutions of ancient civilization.

This is the second temple which has been discovered within a month, the first having been found near the city of Volo. The excavations are continuing.

Personals

Ross & McNeil, architects, formerly located at 45 West 34th Street, New York City, have removed their offices to the Masonic Hall, 46 West 24th Street.

Giaver & Dinkelberg, engineers and architects, have moved their offices to 500-504 Wrigley Building, Chicago, Ill.

Alfred C. Clas announces that he has entered into a partnership with John S. Shepherd and Rubens F. Clas for the general practice of architecture under the firm name of Clas, Shepherd & Clas, with offices at 202-206 Colby-Abbot Building, Milwaukee, Wis. They are desirous of receiving manufacturers' catalogs and samples.

Frederick Ehram, architect, has moved his office from 922 Penn Street to the Mt. Penn Trust Company Building, Reading, Pa.

Fetherstonhaugh & McDougall, architects, announce the removal of their offices from 823 Drummond Building to 85 Osborne Street, Montreal, Canada.

William P. Callahan, architect, 22 Basto Terrace, Boston 31, Mass., is desirous of receiving manufacturers' catalogs and samples.

The Greisler-Abramson Company, architects and engineers, has moved its offices from 523 Lafayette Building to 1033 Walnut Street, Philadelphia, Pa.

Henry C. Pelton, architect, announces the removal of his offices to 151 West 42nd Street, New York City.

Charles B. Meyers, architect, formerly of 1 Union Square, West, New York City, has moved his offices to 31 Union Square, West.

Meisner & Uffner, architects, have opened offices for the practice of architecture at 501 Tremont Avenue, New York City, and are desirous of receiving manufacturers' catalogs and samples.

Kilham & Hopkins, architects, 9 Park Street, Boston, Mass., announce that Mr. William Roger Greeley, having been admitted to the firm, the name will hereafter be Kilham, Hopkins & Greeley.

William Albert Swasey, architect, announces the removal of his offices to the Gotham Bank Building, Columbus Circle, New York City.

HOUSING REPORT of the
CHAMBER of COMMERCE of the
UNITED STATES

WASHINGTON.—The need for adherence to fundamental policies and standards in new housing projects is emphasized in a report prepared by the Civic Development Department of the Chamber of Commerce of the United States which suggests a housing program for American municipalities.

"Housing is a longtime proposition," the report says, "While we may hope that the present acute shortage will be relieved during the next two or three years, we shall have missed a great opportunity if we do not seize the advantage presented by today's interest to secure adequate and satisfactory housing accommodations for the future."

This report was prepared in accordance with a resolution adopted at the housing conference held in Washington last January by the Councillors of the National Chamber. The resolution provided for "a thorough study of the housing situation." The report urges the appointment, where necessary, of a housing committee to estimate the facts; to consider and make recommendations on matters of policy; to encourage the work of other approved agencies.

It is pointed out that the facts as to housing conditions may be ascertained by studying local building construction statistics and by a local housing survey. After the facts had been secured and carefully studied, the report states, a local housing policy should decide:

1. What types of dwelling should be encouraged?
2. Should land values be concentrated in a small area or should they be spread more evenly throughout the community and stabilized by distributing centers of employment, and by the adoption of zoning regulations?
3. Should attention be confined to immediate needs, or should the effect of present work upon the future development of the city be considered?
4. Should all effort be confined to securing the erection of houses immediately, or should some thought be given to their future maintenance?
5. If it is decided to organize a house-building company should this company build to sell; to own and rent or to manage on a mutual basis?

"After policies have been decided a plan of action to give such policies concrete effect must be developed. The report tells of three plans which have been used in various localities, as follows:

1. Aiding local men or firms engaged in building, by the organization of a financing company which will make funds for house building more readily available. Financing corporations of this type have been organized in Akron, Detroit, Minneapolis, Pontiac and other cities.

2. Persuading local industries to erect houses for their employees, as illustrated by the industrial

housing corporations in Middletown, Ohio; Allwood, New Jersey; Beloit, Wisconsin; Flint, Michigan; Janesville, Wisconsin; Akron, Ohio; Woodlawn, Pennsylvania; Kohler, Wisconsin; Fairfield, Alabama; Gary, Indiana; Duluth, Minnesota, etc.

3. Organizing a civic or community housing corporation, either by (a) a group of industries, primarily for the purpose of housing their own employees, or (b) by public spirited citizens for the general well-being of the community. Developments of the above types have been undertaken at: Battle Creek, Michigan; Bridgeport, Connecticut; Cleveland, Ohio; St. Louis, Missouri; Lockport, New York; Philadelphia, Pennsylvania; Washington, D. C.; Wilmington, Delaware, etc.

Local housing experience in the past has shown that one of the big problems to be solved is how to raise the necessary capital. After studying 57 housing and financing companies the Civic Development Department reports that 46 secured their capital by local subscriptions from individuals; 4 obtained it in part from banks, insurance companies, etc., and 1 from the parent company. The report enumerates the sources from which capital may be secured.

Local bank and trust companies; building and loan associations; local subscriptions; life insurance and other fiduciary companies; government aid as by the organization of home loan banks and in other ways.

The report lays special emphasis upon the high cost of building and efforts aiming at reduction thereof. Until cost of house construction reaches a basic level it is not believed that there will be an adequate amount of building. Special attention is given to local conferences of persons or interests directly concerned in the building industry, which conferences provide a basis for compromise and agreement. The reports suggest a number of points that might well be considered in connection with conferences and meetings of this kind.

Second only to the high cost of building as a deterrent to investment in new housing is the general belief that houses erected since the war are not as well built as the older houses. Among the various methods to improve the character of building construction the report enumerates: the practice of giving prizes for best buildings; professional codes of ethics, and building and housing needs. The need for good management is emphasized.

In closing, the report calls attention to the city planning and zoning aspects of housing developments. In this connection the report states that: "A well-planned city not only makes better provision for its housing than does one which grows haphazard, but it greatly increases the security of housing investment by minimizing the likelihood of areas being blighted through the introduction of incongruous developments. This stabilization of values is increased by zoning regulations which determine the use, height and lot occupancy of buildings permitted in any given district."

THE BUILDING SITUATION in
CHICAGO and the MIDDLE WEST

(Special Correspondence to THE AMERICAN ARCHITECT)

CHICAGO.—Owing to the exigencies surrounding the publication of a large magazine such as THE AMERICAN ARCHITECT it sometimes happens that things set down in prophecy by the writer at long-distance become matters of history before the eye of the ultimate dealer strays across the prediction. Such a prefatory warning is necessary in discussing, for instance, the rather mercurial building situation in this important center.

As this is being written in the closing days of May, the building tie-up continues in full force, with only an occasional indication of an early termination. The fact that the opposing interests are meeting at the conference table gives hope, rather than belief, that something may come out of the tie-up shortly and that building soon may be resumed.

Be that as it may, however, the importantly distressing fact remains that a full month of good working time has been eaten out of the building season as far as Chicago is concerned by the inability of the building trades unions and the associated contractors to get together on a working basis of wages. The contractors are still insisting upon a reduction of from \$1.25 to \$1.00 per hour for the skilled builders and from \$1.00 to 70 cts. per hour for the unskilled labor. There have even been suggestions on the part of some contractors that this is the opportune time to reinstate the old working basis of 87½ cts. per hour for skilled labor which was thrown into the discard under pressure of war-time emergencies. The union officials are holding out for a compromise wage, say around \$1.10 per hour, and the latest communication from the union camp is a plea for arbitration. The contractors, recognizing the superior strategic position which they now occupy, are insisting that there is nothing to arbitrate and that an unconditional surrender is the only thing that will reopen building on the important jobs over which they have charge.

The tie-up has been very effective on all principal building projects. Those in process of construction have been gathering cobwebs for a month and those under immediate contemplation have been pigeon-holed for the time being.

The upshot of the wrangle and the delay is to convince the growing crop of Chicago building pessimists that the building boom is not to come to its greatest expansion in this city during the present year. There will be considerable building, it is admitted, if the wage tangle can be adjusted, but the big boom will not really get under way until next year and the proportions of the building program are sufficiently large to insure great activity here for four or five years.

The labor alone is not the only obstacle in the

path of the building program, as has been previously outlined in this correspondence in THE AMERICAN ARCHITECT. Still a more emphatic deterrent is the growing public dread of union "shakedown," materials combinations and other unholy barnacles which have attached themselves to the good ship Progress in these murky waters.

Chicagoans who know their way about have long been convinced that Denmark has had no corner on rottenness, to borrow an allusion from the Bard of Avon. But it has required the scintillant illumination afforded by the Dailey legislative inquiry into Chicago building conditions to bring the whole matter prominently before the people of the city. The Dailey Committee, which has been grinding away very effectively for several weeks, has succeeded in uncovering so much corruption in the building situation that no less than three grand juries are now busy turning out indictments while you wait. A federal grand jury, an ordinary grand jury representing the state system of law and order, and a special grand jury empanelled to relieve the congestion have all been busy. Up to this time a total of nearly 200 indictments have been returned. These charges affect manufacturers, wholesalers, union officials and others intimately connected with the building trade. A variety of unholy combinations has been unearthed. Manufacturers are accused of combining to keep prices up and union agents are accused of combining to shake builders down. Between the "ups" and the "downs," it is palpably obvious that the builders of Chicago have been encompassed by an inescapable ring of graft.

Architects have escaped any accusations of wrongdoing. Apparently, they have been attending to their business and making the best headway possible under the present conditions. That the architects have known for a long time of the impossibility of escaping the "shakedown" on one side or the other, is made clear by the testimony of architects before the Dailey Committee. According to this testimony, architects have set a fixed charge of one per cent. of the total building cost as a fund for paying off graft leeches, mainly from the union sources. This charge has been added in just as any other building charge and the one per cent. has been none too great to meet the rapacious demands that have come from various sources beginning with the excavation and ending only with the hiring of janitors.

Whether anything will come of the reeking exposures in the building trades remains, of course, to be seen. Chicagoans, taken in the mass, are not particularly hopeful. Things have a way of being forgotten in this fair city and the union officials, not to mention the affected manufacturers, are in the habit of using every ounce of "pull" which they possess. Unquestionably, however, the revelations, unsavory as they are, have had an effect upon the

prospective investors in Chicago buildings. Men with money to invest in building and with a former desire to make such an investment are now hesitating, because they have no desire to enter a field so honeycombed with graft.

The building industry, pressed forward by the city's growing needs for buildings of all kinds, will undoubtedly outgrow the present dwarfing exposures, but the effect is being felt just now and it is perhaps as well that all of the diseases have afflicted the poor, prostrate patient at the same time. When the recovery comes, it is not likely that there will be any relapses, for there will be no other diseases for the victim to undergo.

Many building permits, while not yet officially announced, are expected to show an important decline as compared with April, 1921, or with May, 1920. Building permits are, however, an uncertain barometer of building conditions, because many of the permits issued months ago have not yet resulted in any activity.

Reports continue to be heard of important projects which are now about ripe.

One of the unusual propositions now being considered is the proposed First Methodist Church to be built at the corner of Clark and Washington streets in the heart of the Loop district. From present plans it will be unique not only as a church, but as an office structure, and will dwarf many of the other so-called skyscrapers in the business section. The building will be at least twenty-two stories high and will be capped by an immense steeple, which will bear an illuminated cross. Thus the outstanding sign of the Chicago business district will be the sign of God and not the bustling illumination of Mammon. The cost of the church will be \$3,000,000.

As if the \$3,000,000 religious edifice may not prove sufficient to save this encardined city from its wickedness, the city and county, aided by the Chicago Plan Commission, are planning the erection of a \$9,000,000 jail and criminal court building. A proposed bond issue for that amount is shortly to be voted upon, and since bond issues almost invariably carry in Chicago elections, the funds may be considered as already provided.

The plan contemplates the razing of the present inadequate criminal court building, and the construction of a skyscraper, occupying an entire block at Austin Avenue and Clark Street. In this building would be centered all of the criminal court activity of both the city and the county.

The volume of building now actually in progress is insufficient to provide any fixed demand for lumber and building materials and the market accordingly is decidedly apathetic.

Prices in both lumber and materials are merely nominal, the buyer with the spot cash being able to

secure better figures than his less fortunate brother. With the resumption of anything approaching normal demand for lumber and other materials there will doubtless be an almost complete revision of prices.

BUILDING CONDITIONS on the PACIFIC COAST

(Special Correspondence to THE AMERICAN ARCHITECT)

SEATTLE.—Although the demand for building labor has fallen off slightly during the past two weeks, the demand from cities adjacent to Seattle has more than offset the decrease. In Seattle building labor has been in fair demand on work of short duration such as repair and maintenance jobs. With the increase in residence and other construction of a larger nature this class of labor is expected to be called in larger numbers from week to week. Farms and dairies in the North Coast country continue to place orders, although the number shows a reduction over the preceding several weeks. The number of the unemployed men in Washington and Idaho is estimated at between 12,000 and 15,000, but by July 1, through increased construction activities, it is thought that this number will be reduced fully 50 per cent.

The purchase by the Barde Industrial Corporation of an industrial tract in the southern portion of Seattle was the most significant entry of the past two weeks in the brighter outlook for Summer. It is the plan of the buyers to erect suitable warehouses on the property for handling 10,000 tons of steel. About 60,000 square feet of floor space has been provided. The contract has already been let.

The cement market on the coast is stiff. The only two reductions since last Fall were made by the dealers in the decline in sacks and in reductions of their gross margins. Road construction on the Pacific Coast this season, according to the number of contracts now being let, promises to absorb any surplus of cement that might appear at the plants and thus keep the market strong.

There is a slight increase in the demand for sheathing paper. Roofing, plaster and plaster wall board are steady. The brick market remains unchanged.

Probably the most encouraging feature of a return to normal conditions in the fir lumber industry is the voluntary wage reductions from \$3.60 to \$3 base by the Loyal Legion of Loggers and Lumbermen, the force that was organized during the war to keep out sedition and sabotage in the fir mills and camps. The eight hour law will be observed, but conceding that the bottom of the lumber market may not have been reached, that logs are declining in price and that the demand is expected to be light through the Summer, the Legion officially ad-

vised the employers of the new low minimum. This move will undoubtedly result in speedy starting up of many idle lumber mills and bring the percentage up from 70 to 100 per cent. normal.

Average prices at which the mills are now selling building sizes of lumber at the mills are as follows: No. 2 and better 1x4 vertical grain flooring, \$47; No. 3, \$16 to \$25; No. 2 and better slash grain flooring, \$19.25 to \$24.25; finish, \$44 to \$51; No. 2 and better 5/8x4 ceiling, \$20; 1x4 No. 2 and better slash grain ceiling, \$21; drop siding, \$20; boards and shiplap, \$12.50; common dimensions, \$10.50.

The red cedar shingle market is stronger. The mills are sold up for twenty days. Log prices are rising, due to scarcity and practical suspension of logging operations.

Intercostal and deepsea steamship lines about six months ago abolished the crating rule, permitting coast manufacturers of doors to load loose. As a result, manufacturers on Puget Sound have sold and loaded 200,000 doors to the United Kingdom. A brisk enquiry has developed on the Atlantic seaboard for fir doors.

Storage of red cedar shingles, principally 18-inch stock, is about to begin at Tonawanda and Buffalo, according to enquiries from operators in that territory. Low rates intercostal and the Erie barge canal as compared with the all-rail haul seem to be the incentive. It is believed here that the shingle market is on the turn.

What Is Radically Wrong?

A GREAT many persons have asked either themselves or others this question of late, and there have been few answers so completely satisfactory as this one by George D. Roberts, vice-president of the National City Bank of New York. Mr. Roberts is one of the keenest students of our economic and industrial situation in America, an official in one of the world's really great banking institutions, and a banker of international repute.

This is Mr. Roberts's answer to the question:

"It is a common declaration in these days, uttered usually with an air of profundity, that there must be something radically wrong with society, that millions of people should be out of work, millions more unable to sell their products and millions suffering want. Since something is assumed to be radically wrong it presumably follows that something ought to be done about it, and the talkers generally are ready to do it, although the ideas of such people as to what should be done are exceedingly vague.

"It is admitted that something is radically wrong. It is wrong that great numbers of people

should be so ill-informed about economic affairs that instead of acting in a manner calculated to secure cooperation and stability they use their influence to break down the delicately balanced industrial organization and create confusion and disorder. The modern industrial organization is dependent upon intelligent, voluntary, harmonious cooperation on the part of all the people. It requires that the people shall distribute themselves according to choice in the various industries, and so direct their individual policies as to keep the industries in balance and accomplish a ready exchange of products. If through mistaken ideas of self-interest they organize themselves into groups, either national groups, class groups, or occupational groups, and become so intent upon forwarding group interests that they lose sight of the necessity for general cooperation, the whole modern system of highly-developed industry will break down. It will be strangled by too much organization. There is indeed something radically wrong with society, and this is it."

Unemployment in Great Britain

A SUMMARY of unemployment in Great Britain issued by the British Ministry of Labor indicates, states the foreign information section of the Bankers Trust Co. of New York, that in the latter part of March over 2,000,000 persons in some 80 lines of industry coming under the scope of National Unemployment Insurance were wholly or part time without work. Of this number, according to the official detailed figures, which have just been received by the Bankers Trust Company, of New York, from its English Information Service, 1,355,206 persons were wholly unemployed, and 838,662 were on part time.

By the middle of April the number wholly unemployed had increased to 1,686,900. Government unemployment benefits and out-of-work donations of £1,563,000 were paid in the week of April 9, compared to £999,000 in the preceding week. Under the Unemployment Insurance Act benefits range from six to fifteen shillings a week, the lower amount being paid to young girls and the maximum to men. Not more than 15 weeks' benefits can be received in one year. Employes, employers and the Government support the insurance fund. Contributions from employers and employes run from 3½ pence to 8 pence per week for each person insured, the firm and the worker about equally sharing this expense.

The Labor Ministry's detailed summary shows that the greatest number wholly unemployed in a single industry were engineering trades workers but the greatest number on part time were in the cotton textile industry.

6362

Yacht piece # 110. 2370

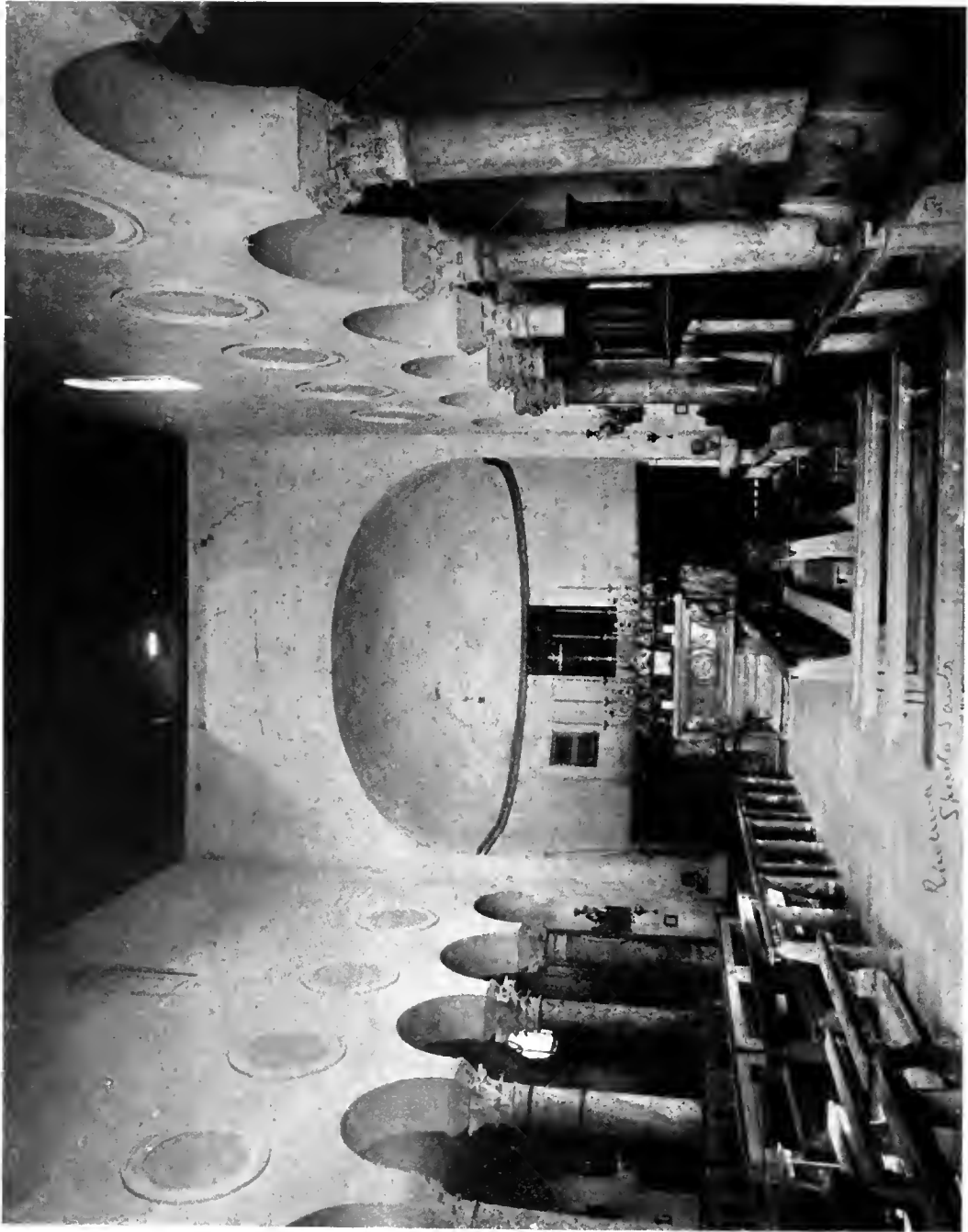

BASILICA OF S. SPIRITO, RAVENNA, ITALY

THE AMERICAN ARCHITECT

VOL. CNIX

WEDNESDAY, JUNE 22, 1921

NUMBER 2370



VIEW IN MAIN BANKING ROOM

CREATING a NEW INVESTMENT CENTER in NEW YORK

With Special Reference to the Building of S. W. Straus & Company, Fifth Avenue at 46th Street, New York

WARREN & WETMORE, *Architects*

TO the thoughtful and prudent man, the word finance means something more today than it did fifty years ago. In fact, it has now a double meaning and that meaning is controlled by the man's attitude towards the use, or abuse, of money.

Years ago "the financial district" was Wall street and its vicinage. To that district went men and groups of men,—corporations,—to find money to float all the many schemes, sound and "wildcat," that man's ingenuity and rush for wealth could invent. There was no well drawn line between opera-

tions in money that on the one hand sought out safe, and sure investment, or on the other took all the hazards of the gambler in mad orgies of speculative gambling. No matter how carefully or conservatively certain groups of men tried to segregate the mad elements of speculation from the saner seeking-out of safe investment opportunity, there was the taint of the gambler over it all. Clients, feeling they were classed with the "lambs" were loathe to trust those who lived so intimately with the "bulls and bears" of finance.

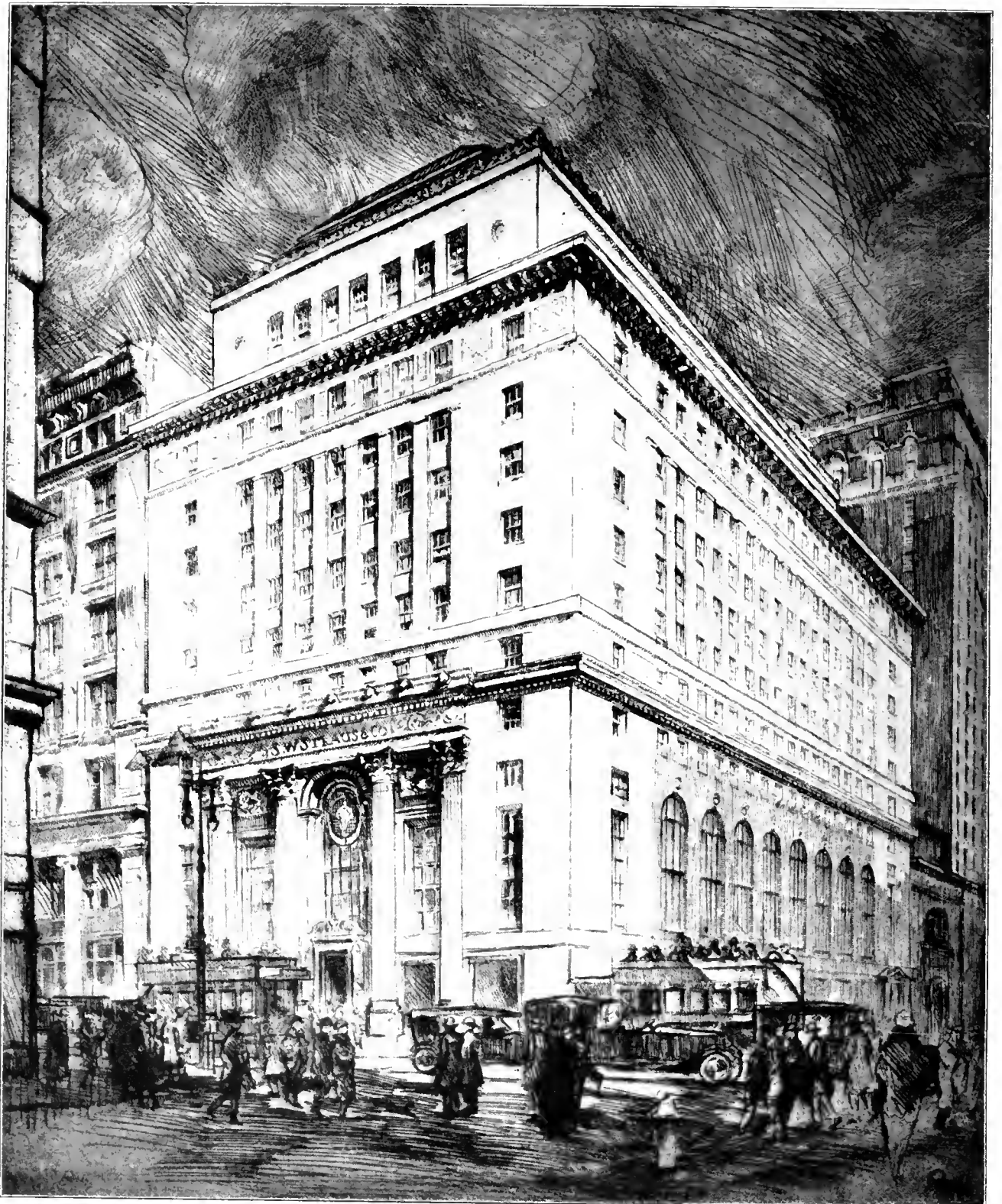

BUILDING FOR S. W. STRAUS & CO., FIFTH AVENUE AT 46TH STREET, NEW YORK

WARREN & WETMORE, ARCHITECTS

From an Etching by Paul Roche

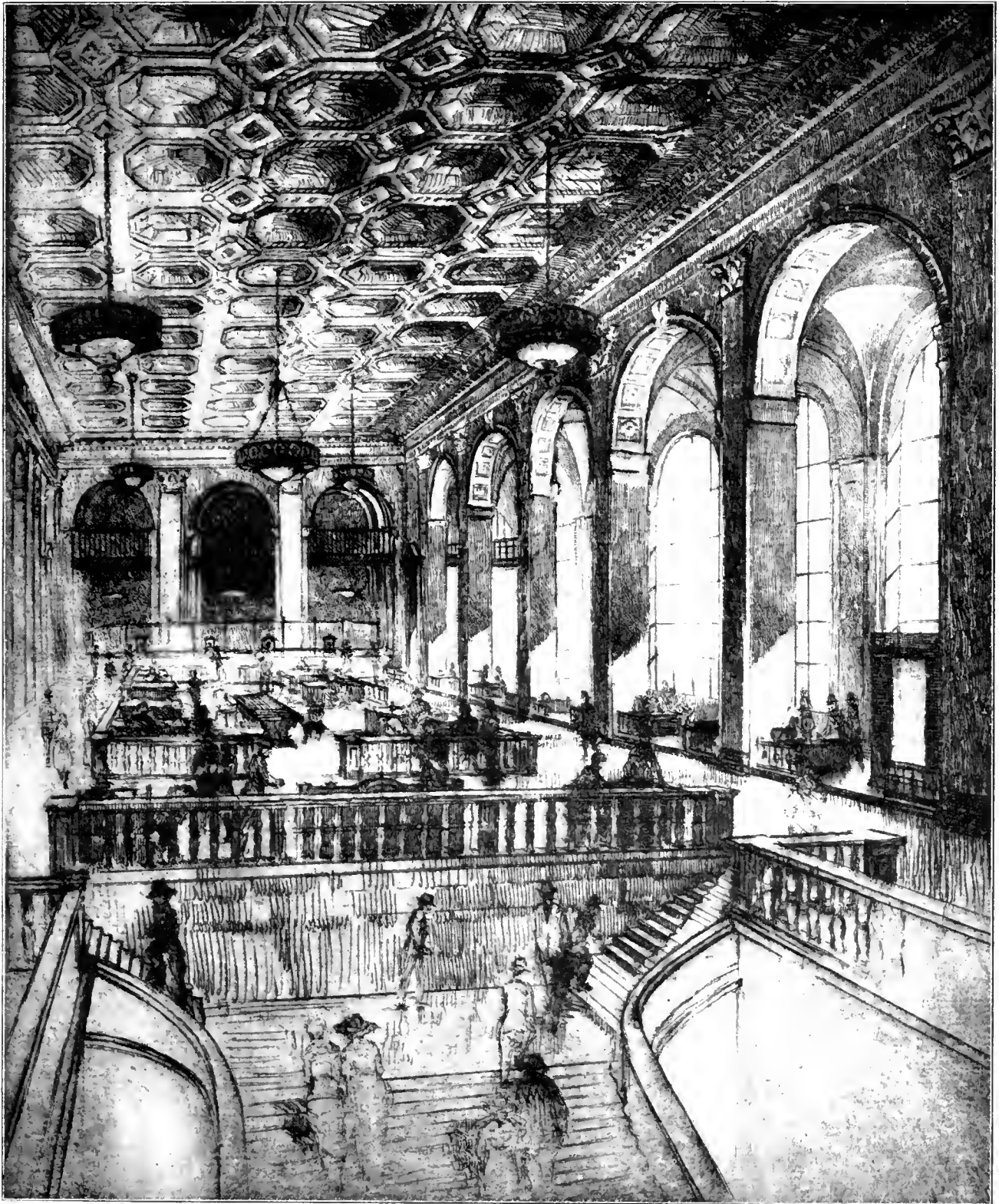

MAIN BANKING ROOM
BUILDING FOR S. W. STRAUS & CO., FIFTH AVENUE AT 46TH STREET, NEW YORK
WARREN & WETMORE, ARCHITECTS
From an Etching by Paul Roche

THE AMERICAN ARCHITECT

The large and solidly founded investment organizations with the prudence and foresight that had enabled them to become large and solid, sought for a location, a section of the city that would afford a proper opportunity to group a finely conceived lot of buildings in a neighborhood, dignified and proclaiming the safe and solid character of their enterprises.

Fifth avenue, "the finest street in the world," was logically the place, and that, until that time undeveloped section for business purposes, lying between Forty-second and Fifty-ninth streets, was the particular part selected for the grouping of the investment, financial operations.

of solid wealth exactly as did the old New Yorkers.

This present writing is not intended so much to draw the reader's attention to the building of S. W. Straus & Company, the latest addition to this rapidly growing investment section, as it is to accent further, as was done in another reference in this issue, the great commercial value of the conservation of an architectural resource.

Naturally in contemplating a structure to be erected in a location that had already splendidly developed, the promoters would seek to erect a structure that, while adequately meeting the requirements of a great investment business, would become an ar-



PRESIDENT'S ROOM

FROM its earliest development this section has been the heart of aristocratic New York. It marks the summit of Murray Hill, the very heart of the richest residential section. All about the many dignified buildings that are crowning this neighborhood are yet to be seen the "brownstone fronts" whose owners have from father to son occupied them for many generations. It was the solid families of New York that dwelt in these quiet, stately mansions, and it is, therefore, fitting, if they are to give way to a new order, that they should be set aside for equally aristocratic structures that promote the basis

tistic asset to the city. This is certainly an unselfish motive and one with all the attributes of good citizenship.

THE Straus Building is on the Northeast corner of Forty-sixth street and Fifth avenue. It was designed by Warren & Wetmore, from whose offices have come the plans of a majority of the buildings forming the Grand Central Station group.

The building covers the whole of the corner property which has a frontage of 100 feet on Fifth avenue and 180 feet on Forty-sixth street. The

THE AMERICAN ARCHITECT



EAST SIDE, BANKING ROOM, SHOWING FIRST MEZZANINE FLOOR



LOOKING ACROSS BANKING ROOM FROM FIRST MEZZANINE FLOOR

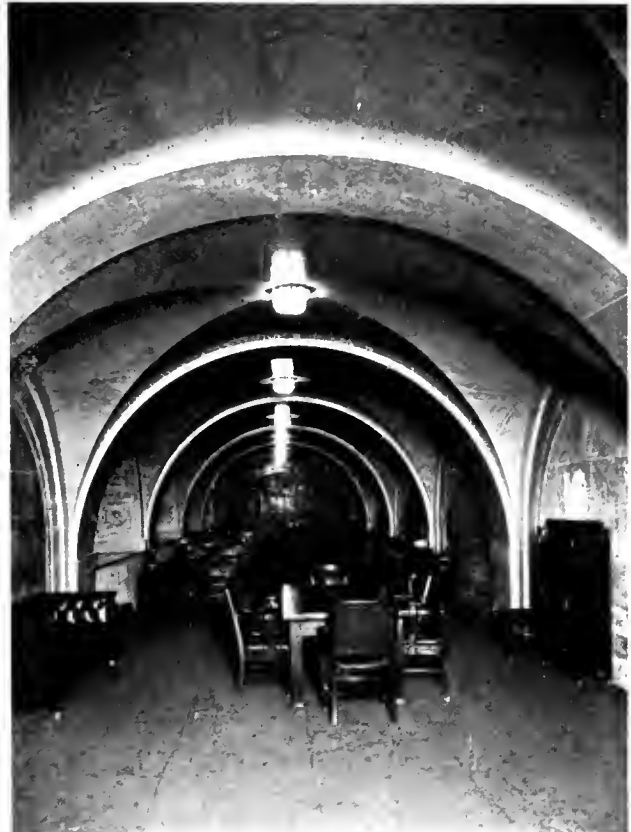

LOOKING ALONG FIRST MEZZANINE FLOOR ON EAST SIDE OF BANKING ROOM

BUILDING FOR S. W. STRAUS & CO., FIFTH AVENUE AT 46TH STREET, NEW YORK
WARREN & WELMORE, ARCHITECTS

THE AMERICAN ARCHITECT



LADIES' ROOM



ENTRANCE ON 46TH STREET

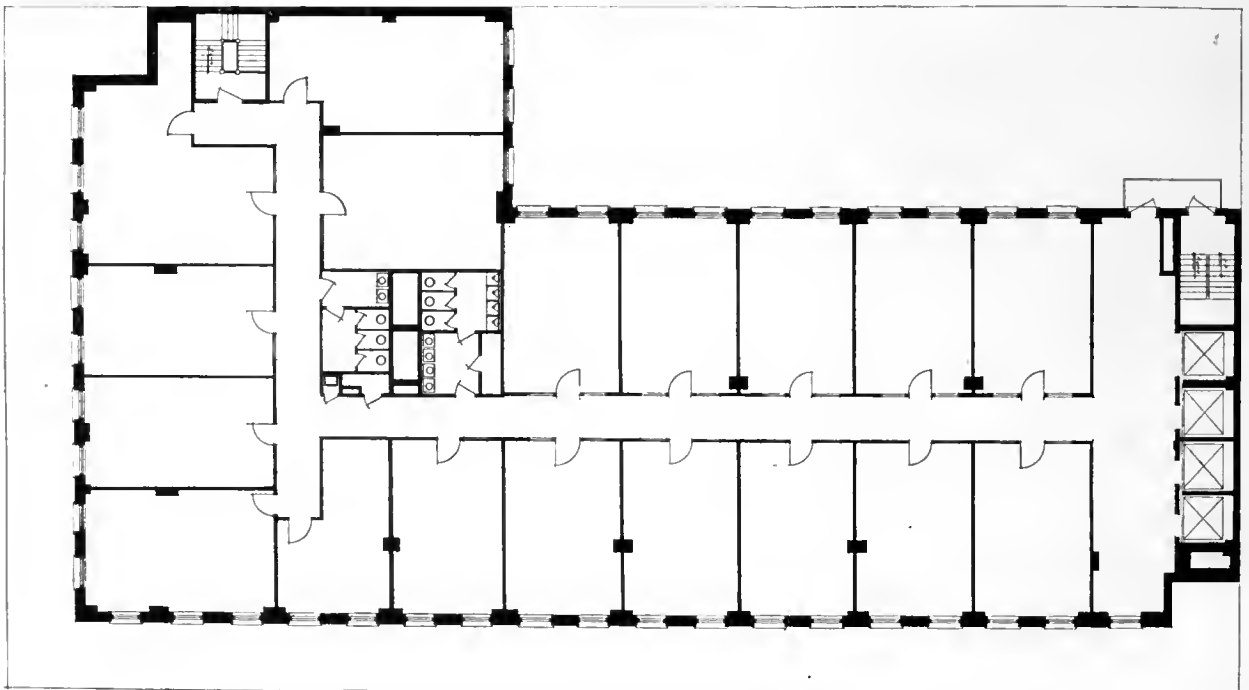

FIRST AND SECOND PENT HOUSE FLOOR PLANS
BUILDING FOR S. W. STRAUS & CO., FIFTH AVENUE AT 46TH STREET, NEW YORK
WARREN & WETMORE, ARCHITECTS

THE AMERICAN ARCHITECT

general character of the building and its interior plan and detail are adequately shown in the accompanying pictures. It possesses no unusual architectural engineering features and no notable physical difficulties were encountered during construction. The foundations go to solid rock and the structure of steel with cinder concrete floors and hollow tile



STAIRWAY LEADING FROM FIFTH AVENUE
ENTRANCE TO BANKING ROOM

partitions carries a remarkably low insurance rate. The exterior walls are of brick faced with buff colored Bedford limestone.

The main entrance is on Fifth avenue and a handsome and architecturally satisfying staircase, designed on a scale commensurate with the dignity of the establishment, gives one immediately a sense of the artistic fitness of the banking room to which it leads. The stairway leads first to a wide landing, from which stairs lead on either end to the right and left to the main or banking floor.

The banking room has a height of 40 feet and has on three sides a mezzanine floor, the ceiling of which is arched. This floor is given over to desks of stenographers and securities salesmen. The desks

of the directors and heads of departments are on the main floor along the sides, with handsome offices for the use of those whose work demands quiet and freedom from interruption, in the front of the building. The interior is marble for the banking room and walnut for the wood finish of the private offices. All metal railings and grills are of quiet colors set off with gold.

A second mezzanine floor is used for offices of the S. W. Straus & Company, but this floor is not seen from the banking floor, which occupies the place of a court from the ceiling of the ground floor to the ceiling of the second mezzanine, or, properly speaking, the fourth floor. On the ground floor there is a store on each side of the Fifth avenue entrance and three stores fronting on Forty-sixth street. Two push button electric elevators of small size are used for intercommunication between the floors used by the company. One is on the north side of the main entrance and goes from the ground floor to the second mezzanine; the other is on the south side of the building and goes only from the banking floor to the second mezzanine. These elevators are for the use of the principal officials and for emergency use by all employees.

The main elevators, four in number, are in the Forty-sixth street entrance corridor. They are finished with walnut and give the impression of handsome rooms and not of elevator cages. They are operated by electricity and have a speed of 300 feet per minute. They give access to eight floors, each of which contains offices to be rented. There is a light court on the north side, the south wall of which is carried on a line of columns on the north side of the banking room. A central hallway on each floor assures good window lighting for all offices. The present divisions provide 18 offices on each floor, but the tile partitions allow of changes to suit tenants.

In the basement there are two lounging rooms for employees of the S. W. Straus & Company, one for women and one for men, as well as a ladies' dining room and men's dining room. The kitchen has a quarry tile floor and white tile walls. Lunches are served to 200 persons each day. Heating, lighting and ventilation are of the usual type in the best office buildings.

The first movement towards the creation of a new investment center in New York, it is claimed, was carried forward from an original idea of Mr. S. W. Straus. Having decided on this radical change of location and selected a site, Mr. Nicholas Roberts, vice-president of the S. W. Straus & Co., was placed in entire charge. During the progress of the work, Mr. Roberts called to his assistance Mr. Charles G. Duffy, architect and engineer, who served in all matters as technical advisor.



MAIN LOBBY

THE AMBASSADOR HOTEL

PARK AVENUE, NEW YORK

WARREN & WETMORE, *Architects*

NEW YORK'S enormous transient population increasingly demands hotels, and then, more hotels. Five years ago the over-cautious investor was quite certain that New York was fully provided with hotel accommodations to meet its need far into the future. In fact, he was not certain if the city was not over-built as to its hotels. Yet, since that time there have been erected the Commodore, the Pennsylvania, the Biltmore and others which have added approximately four thousand rooms to New York's hotel capacity. In spite of this substantial addition, every prudent man visiting this City secures his "reservation" days and even weeks ahead. If he has not, he will find himself tramping the streets at night, vainly seeking a place on which to lay his head.

New York's hotels are famous not only all over our own country, but throughout Europe. They combine elements of good architecture and the most correct equipment. Not always have they in their decorative treatment been everything that could be desired, but during recent years elements of quiet

refinement have been introduced and the erstwhile garish, flamboyant types are not recurring.

The new Hotel Ambassador on Park avenue, Fifty-first to Fifty-second streets, is one of the newest and, in some respects, most progressive in its exterior and interior design of recent hotel construction in New York. Hotels are the temporary homes of strangers. Even the ubiquitous traveler feels a certain sense of lonesomeness when he contemplates the average hotel interior, particularly his bedroom. In designing and equipping the Hotel Ambassador, the object was to remove as far as possible the usual "hotel" atmosphere and to create the same feeling of "at-homeness" that one feels on entering a private house.

THE methods of standardization usually pursued in the furnishing throughout the house are not evident at the Ambassador. The furnishings, in the main, are copies of fine old examples of masterpieces of good craftsmanship that have been produced during the world's progress in decorative art. In this

THE AMERICAN ARCHITECT

way the Ambassador has, in its interior aspect, escaped the stigma of commonplaceness, has avoided the monotonous and has set a new standard in decoration and equipment.

Reference to the typical plan will show how the spirit of domesticity was carried out in the designing of the guest floors of this hotel. The guest may "cut his coat according to his cloth." He may indulge his desire for comfort and privacy to the full

in every place is harmonious and good. Best of all, it is restful and shows its quality inasmuch as it does not blatantly assert it.

The illustrations accompanying this article indicate the general character of the interior, save only as to color. As before stated, the color is effected with fine judgment.

The exterior, also to be judged from the illustrations, is of a style and character that harmoniously



CIRCULAR LOUNGE ON MAIN FLOOR

extent of his purse. The standard hotel room and bath, all perfectly appointed, may be had, or ranging through suites of varying sizes the guest may have his own apartments with their specially assigned servants. He may, if he likes, take his meals in any of the grills or sumptuous dining rooms or he may surround himself with exclusiveness and dine, *en famille*, or in the company of his selected guests. These things add new elements to hotel life, and rob it of much of the lonesomeness that one always feels when tossed into new surroundings.

The general decorative features of the interior are, of course, in keeping with the high class service the Ambassador sets out to render. The color scheme

relate with other fine structures that line either side of Park avenue from the Grand Central Station group on the South, stretching North to Fifty-ninth street.

MUCH has been said in these pages as to the necessity for the conservation of our architectural resources in New York if we are ever to redeem the city from the many errors that have been committed in the past. The first step, and the most important, was the enactment of zoning regulations. The fine effect of these restrictions is beginning to be apparent all over the larger city, but in no place

THE AMERICAN ARCHITECT



LOUNGE ON MAIN FLOOR



LOUNGE
THE AMBASSADOR HOTEL, PARK AVENUE, NEW YORK
WARREN & WETMORE, ARCHITECTS

THE AMERICAN ARCHITECT

is it in better evidence than in this rapidly building-up Park avenue section.

The upper stories of the Ambassador have been designed to meet zoning rules. Contrast the present effect with what would have happened if the usual flat topped roof had been designed. To sense further the good effects of these zoning restrictions, the saunterer along Park avenue has only to scan the view either North or South. Here he will find that an architectural resource has been most carefully conserved and that a section has been created that will insistently and for all time proclaim

the wisdom of these well considered restrictions.

The Ambassador, claimed by its promoters to be an aristocrat of hotels, sits in dignity amidst aristocratic surroundings. The effect of environment, good or bad, on the frequenter is conceded. The men or women who gain their first impression of New York from living in a hotel so well designed and so finely equipped, will not accuse us of unduly claiming that ours is a city of homelike hotels, where the transient visitor may find rest, recreation and a large measure of education in things as they ought to be.



LOUNGE ON MAIN FLOOR

Christ Church, Alexandria, Va.

(See reproduction of original drawing by O. R. Eggers on opposite page)

CHURIST CHURCH in Alexandria, Va., was, before the addition of its present tower, typical of a class of church buildings erected during our Colonial period. It was a plain, foursquare building, with a hip roof, and its main architectural features were the cornice and the finish of doors and windows. These received the considerable attention that was characteristic of the work of the skilled Colonial builder.

George Washington was one of the first vestrymen of this church, and the pew he occupied remains today as it was in Washington's time.

General Robert E. Lee, who commanded the Confederate forces during the Civil War, was also a member of this church, coming from his stately home in Arlington, a sketch of which house has been made by Mr. Eggers for this series.

648⁵



CHRIST CHURCH, ALEXANDRIA, VA.
THE AMERICAN ARCHITECT Series of Early American Architecture



The Advancing Architect

THE homely simile of "the tail wagging the dog" may very correctly be used when referring to certain conditions in the building trades all over the country.

Naturally, an industry so centrally controlled by organizations that represent elements of labor, as building, will exert its influence wherever building is carried forward. It is, therefore, worthy of particular mention when an instance where a group of organized architects so thoroughly realize their responsibilities to their professional brethren and their duty to the general public is presented.

On another page in this issue there is printed a communication from the Illinois Society of Architects to the Building Contractors' Organizations in Chicago. Contrast the wide-awake attitude of this aggressive state organization with that of organized bodies of the profession not only in Illinois, but throughout the entire country. The aggressive attitude of the Illinois Society places the profession of architecture exactly where it belongs, as the dominating factor in every building operation.

THE contention set forth in the communication of the Illinois Society that contractors have neither a moral nor a legal right to fix working conditions and wages that the public will have to abide by without the public being fully represented in the making of such agreements, is absolutely sound. Such an arrangement is directly in violation of a constitutional right. If the construction organizations will invite the architects into their councils, the public will undoubtedly have more respect for these agreements, inasmuch as they will correctly feel that their interests in these matters will be fully protected by men who are competent to represent them.

A precedent of this sort was established when the National Board of Jurisdictional Awards was formed. In this Board the owners, investors and the building public are directly interested through the architects and engineers on the Board. Making the profession of architecture a third party to all agreements insures elimination of the restrictive features that now adversely affect every building operation.

Labor having in the past secured through the influences of its voting power every law that it could

demand, it is now time carefully to consider just how such laws affect the general interest and what further enactments there might be equally to insure the rights and privileges of the public.

THE wise suggestions of the Illinois Society, presented to the Dailey Legislative Committee are pertinent. Summarized, these laws would make any labor organization legally responsible under the law that it should be a felony either to demand pay or accept graft. It was further suggested that a statute be enacted, modeled after the pure food law, making it a felony for any manufacturer, retailer or distributor of building materials, to deliver any materials of a lower quality than ordered.

By such wise suggestions and in many other equally valuable directions has the Illinois Society been efficiently representing the profession of architecture. Similar good work on the part of organized architecture in every state would quickly lift the clouds that now hover over the building industry. And, what is equally desirable, firmly establish the profession of architecture as a wise and necessary element in every plan that affects the building industry in this country.

State Societies

IN a paper presented to the recent convention of the Institute by delegates from four State societies in Western States it is made evident that those societies desire the closest co-operation.

Further, every progressive movement in which the Institute is engaged is fully endorsed by these societies. Hundreds of men, now members of State societies, but who in all probability will never become affiliated with the Institute, are, by this declaration, ready and willing to work for the best interests of the profession. Can the Institute afford to ignore this important group?

Encouragement of this movement by the Institute will not lessen its authority in the profession, but would serve to broaden it and bring under it every man legally entitled to practice.

It is entirely supposable that the Eastern State societies endorse the action of their Western brethren. But, where were they in the convention? Should they not "stand up and be counted?"

TRADE AGREEMENTS in CHICAGO

The Illinois Society of Architects Questions Contractors' Rights Arbitrarily to Fix Working Conditions and Wages

THE following communication was on June 1st forwarded by The Illinois Society of Architects to The Building Construction Employers' Association and The Associated Builders of Chicago.

Gentlemen:

We are advised that your associations have officially offered to renew existing trade agreements with the members of the Chicago Building Trades Council on the basis of \$1.00 per hour for skilled labor, it being our understanding that all of the various trade agreements between your associations and the various labor unions expired yesterday by time limitation.

We are not unmindful of the fact that the execution of such agreements has in the past so operated as to make Chicago a closed city; that the actual operation of the agreements executed by your associations fixing working conditions, restricting the number of apprentices, the establishment of the principle of the job stewards, the closing of all avenues of employment in connection with all building operations to all other than members of the Building Trades Council of Chicago has so acted as to enhance greatly the cost of all building construction, largely through a gradual reduction in the amount of work performed per day by the mechanics of all trades. The increased cost of building construction due to the operation of these closed agreements, which have actually erected a Chinese wall around Chicago, has been variously estimated at from five to thirty-five per cent. We are of the opinion that all such closed agreements are against public policy and should not be renewed.

The Board of Directors of the Illinois Society of Architects at a special meeting held today directed the president of the society formally to inquire of you by what legal or moral right your associations have presumed as your justification to negotiate with and to execute contracts fixing working rules and conditions as well as the rate of wage which will so operate as to compel the building public to abide by without the building public as represented by some organization being a party to said negotiations and agreements.

We, however, recognize that custom has sanctioned the making of agreements fixing the wage scale, working conditions, etc., and we therefore suggest that your existing official offers to the members of the Building Trades Council to renew existing agreements should at once be withdrawn, and that the Building Trades Council be officially advised by your associations that before any new agreements can be entered into that the interest most largely affected,

the building public, must be consulted and its approval obtained, and while we assume that your associations do attempt to represent the public as best you may, yet we suggest that some organization or organizations representing more directly the building public than either the contractors associations or the labor unions should be consulted in the making of all agreements both as to working conditions and as to the wage scale. Indirectly, the fixing of the rate of pay for skilled mechanics in the Building Trades as a matter of fact indirectly fixes the rate of pay for similar labor in the territory covered by such agreements and we question both the moral and the legal right of any association or organization to execute any agreements that either directly or indirectly fix the rate of pay which owners and investors in buildings who are not members of your associations will be compelled to pay without having been either directly or indirectly represented.

We at the same time earnestly desire some authoritative statement from your associations showing the justification of your offer to renew existing trade agreements on a \$1.00 per hour basis and we venture the assertion that just as sound economic reasons may be advanced as to why the rate of pay for skilled mechanics for the coming year should not be more than 80c. per hour as any reasons that your associations may be able to advance in justification of your offer of \$1.00 per hour.

Owing to the general economic unrest, the stagnation in business, the admitted need for housing, the unwillingness of investors to proceed with work at present high costs, permit us to suggest to your associations the absolute need for a general revision of the working rules which have so operated as to limit output; that the elimination of all rules limiting output are equally as important as a general reduction in the wage scale, and we believe that the differential wage scale of previous years was more equitable than the wage scale submitted by you. We further suggest that the building mechanics be officially notified that if reasonable working agreements are not executed within a certain fixed time that your associations will feel justified in starting construction work under the American or open shop plan, which has been recently inaugurated in Pittsburgh, Cleveland, Boston, Philadelphia, Minneapolis, St. Paul, Atlanta, Youngstown, Memphis, New Orleans, Omaha, Portland, Baltimore, Washington, Dallas, and other large cities.

We are convinced that if such a plan for new working agreements is put into operation that it will do much to restore conditions under which it



BUILDING FOR S. W. STRAUS & CO., FIFTH AVENUE AT 46TH STREET, NEW YORK
WARREN & WETMORE, ARCHITECTS

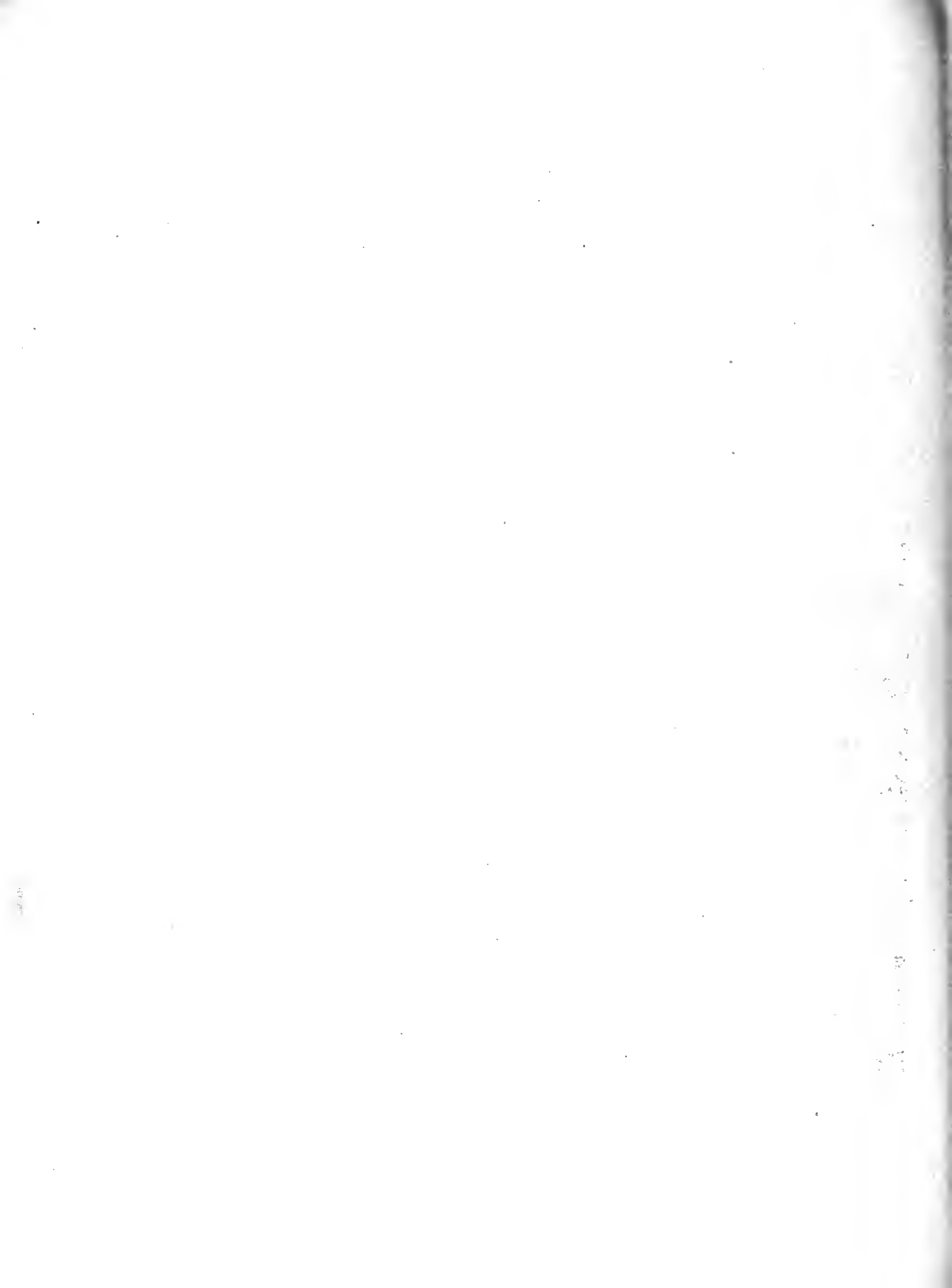



DETAIL OF FIFTH AVENUE ENTRANCE
BUILDING FOR S. W. STRAUS & CO., FIFTH AVENUE AT 46TH STREET, NEW YORK
WARREN & WETMORE, ARCHITECTS



THE BANKING ROOM
BUILDING FOR S. W. STRAUS & CO., FIFTH AVENUE AT 46TH STREET, NEW YORK
WARREN & WETMORE, ARCHITECTS



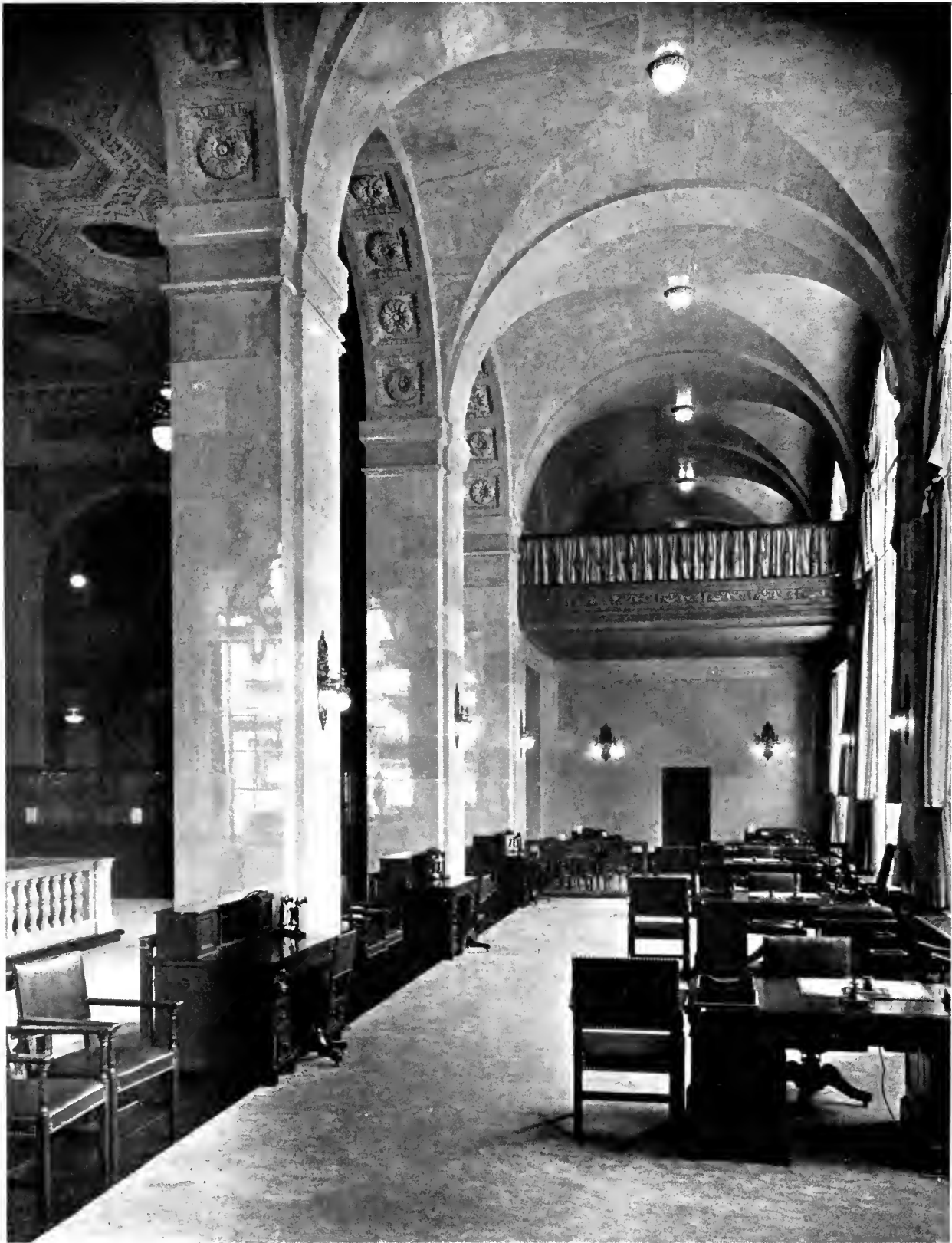

DEPARTMENTAL OFFICES, SOUTH SIDE BANKING ROOM FLOOR
BUILDING FOR S. W. STRAUS & CO., FIFTH AVENUE AT 46TH STREET, NEW YORK
WARREN & WETMORE, ARCHITECTS



LOOKING FROM BANKING ROOM FLOOR ACROSS MAIN ENTRANCE STAIRWAY
BUILDING FOR S. W. STRAUS & CO., FIFTH AVENUE AT 46TH STREET, NEW YORK
WARREN & WETMORE, ARCHITECTS

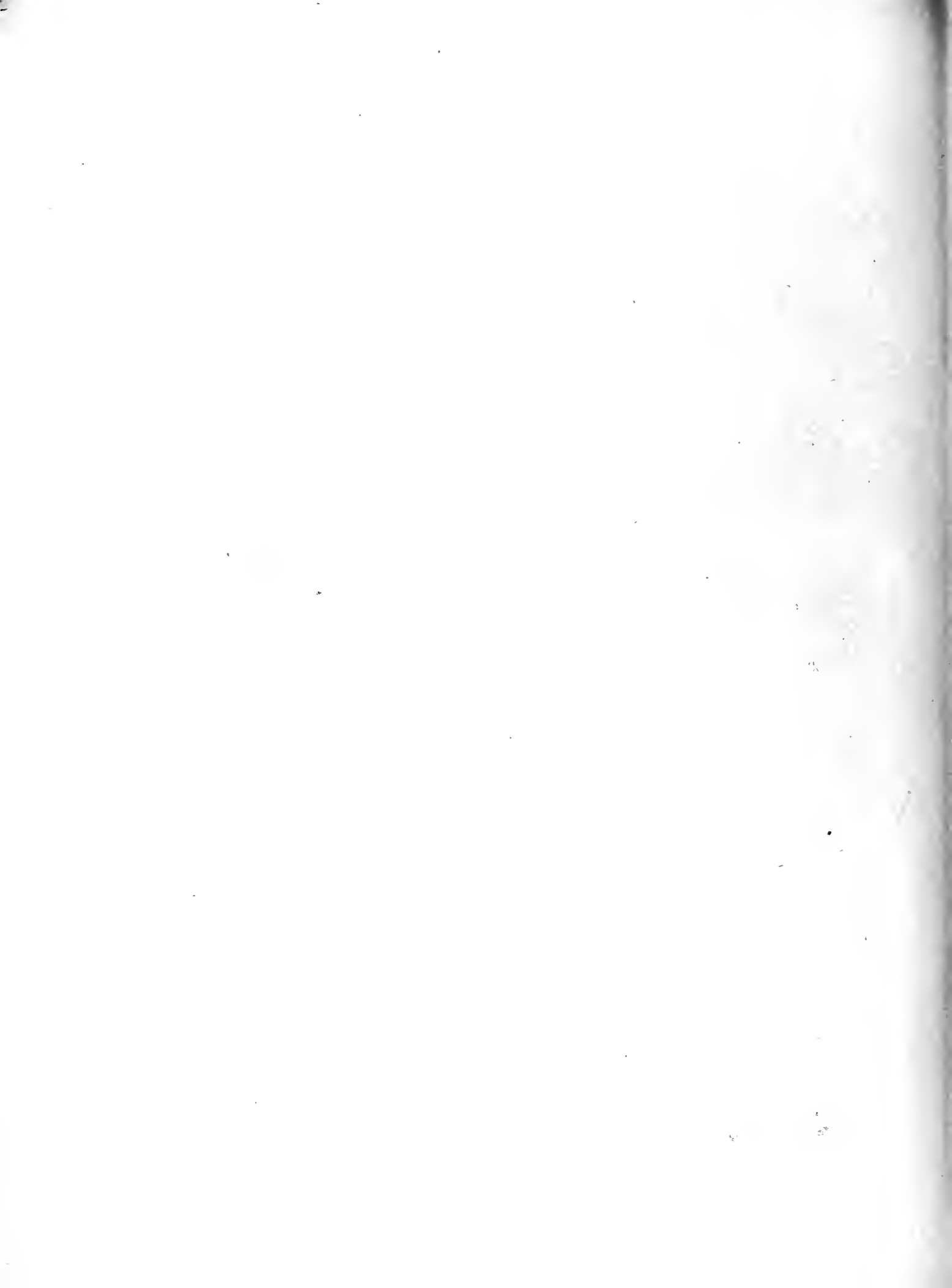

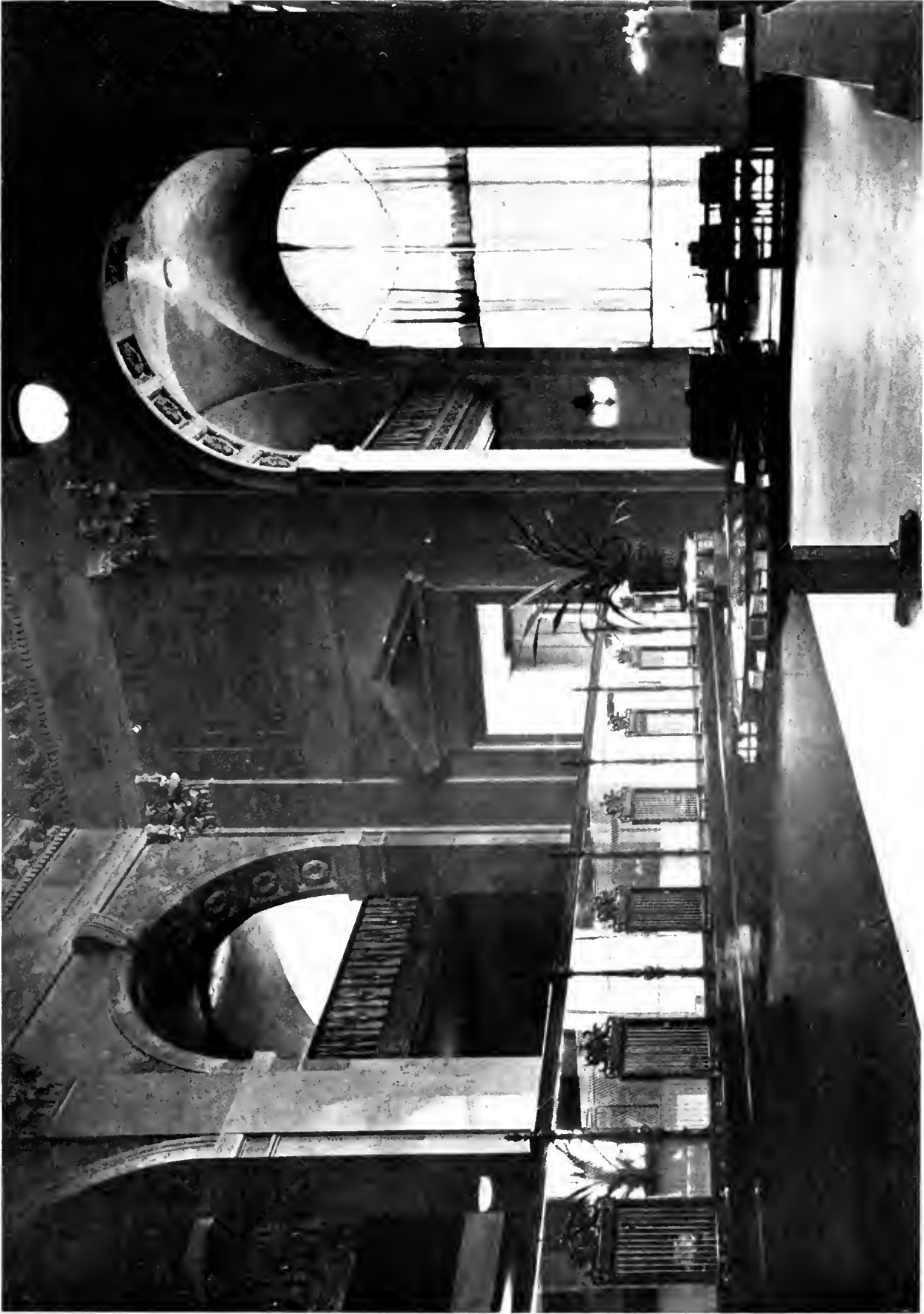

SOUTHEAST CORNER OF BANKING ROOM FLOOR
BUILDING FOR S. W. STRAUS & CO., FIFTH AVENUE AT 46TH STREET, NEW YORK
WARREN & WETMORE, ARCHITECTS



6507

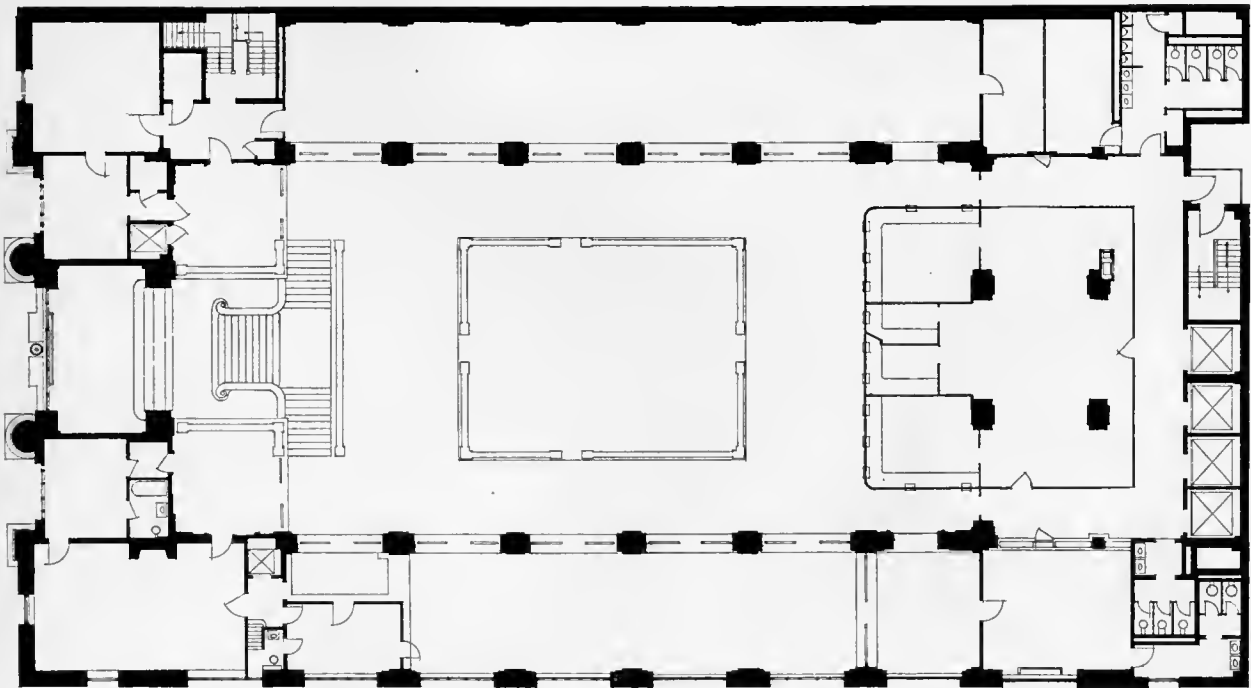

BANKING ROOM FLOOR PLAN

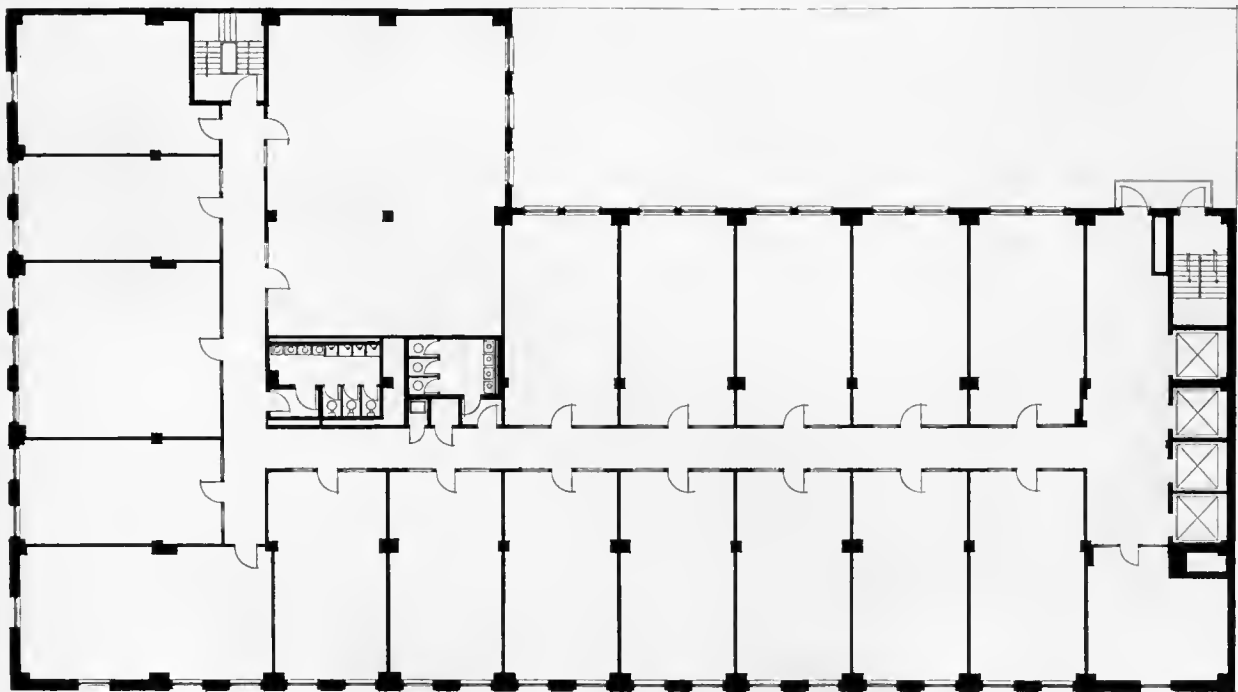

TYPICAL FLOOR PLAN

BUILDING FOR S. W. STRAUS & CO., FIFTH AVENUE AT 46TH STREET, NEW YORK
WARREN & WETMORE, ARCHITECTS



6508

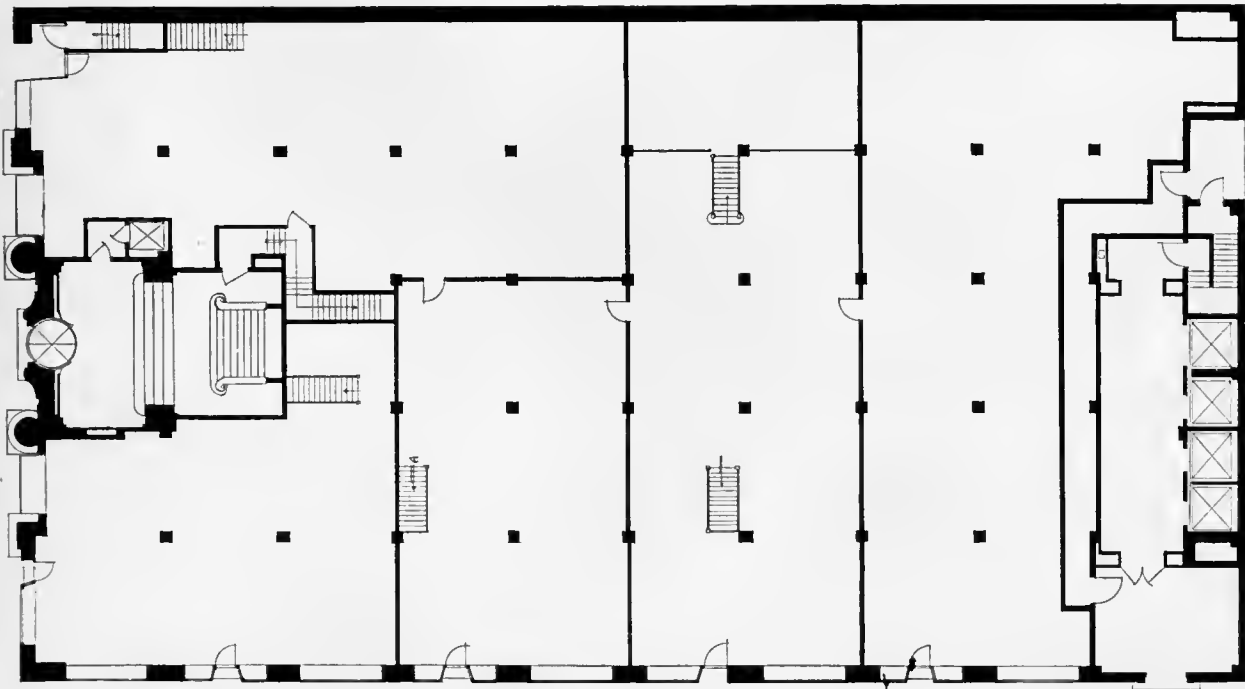

GROUND FLOOR PLAN

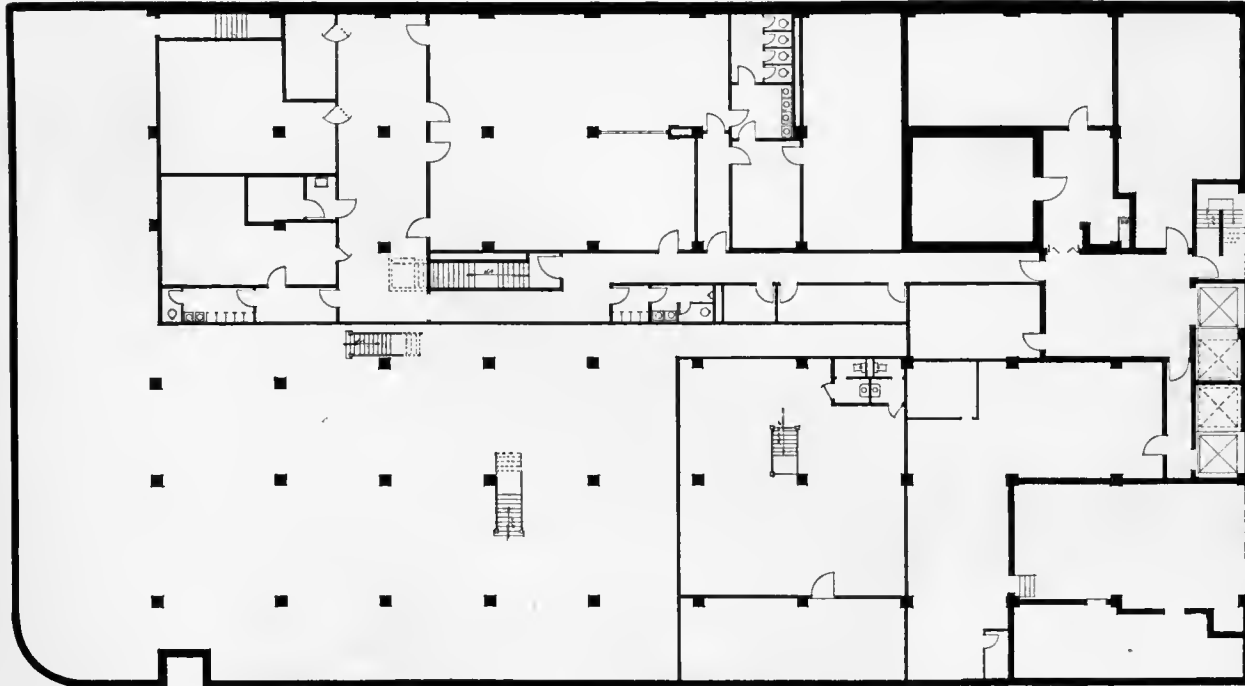

BASEMENT FLOOR PLAN

BUILDING FOR S. W. STRAUS & CO., FIFTH AVENUE AT 46TH STREET, NEW YORK
WARREN & WETMORE, ARCHITECTS





THE AMBASSADOR HOTEL, PARK AVENUE, NEW YORK
VIEW FROM SOUTHWEST
WARREN & WETMORE, ARCHITECTS

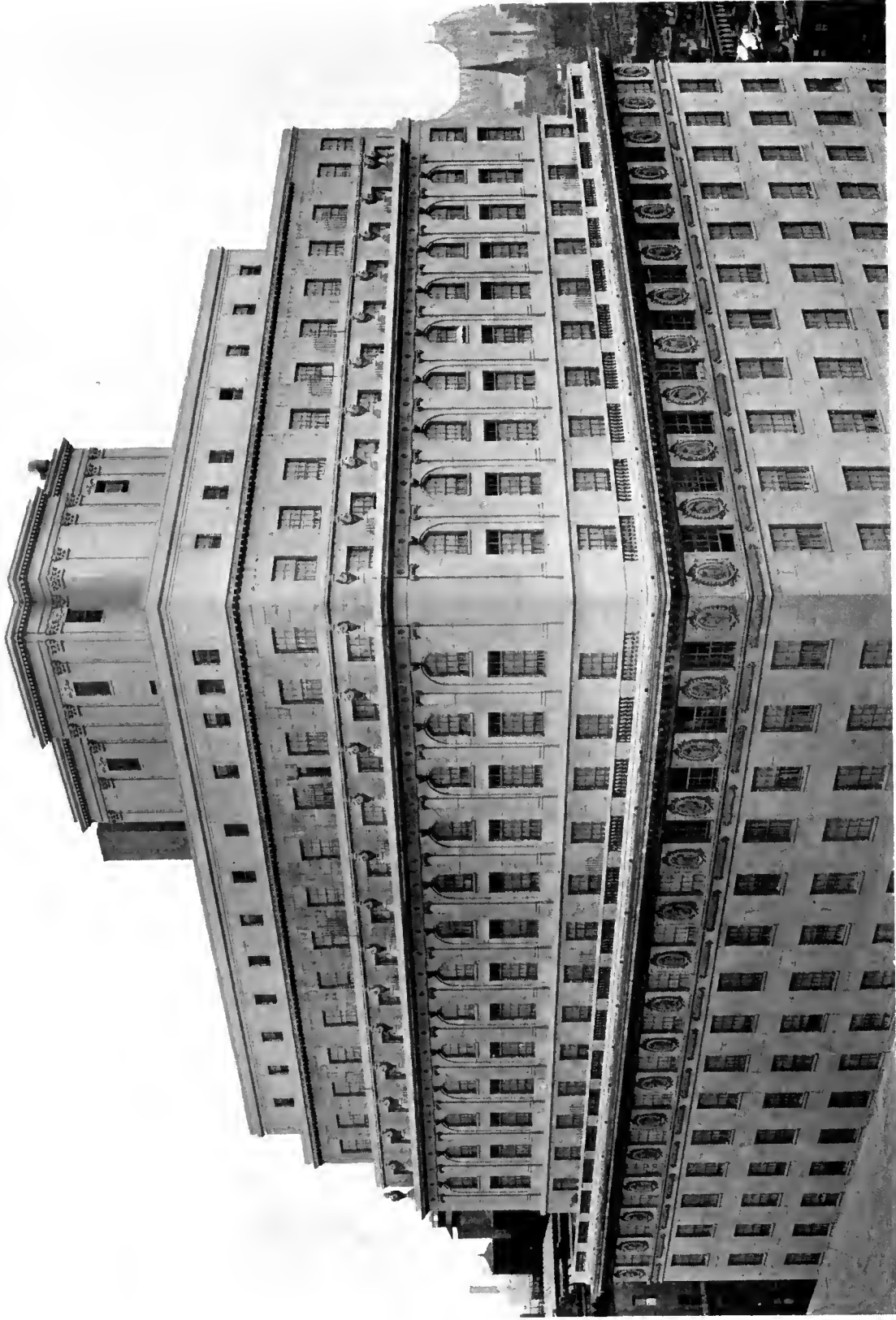

VIEW OF UPPER STORIES
THE AMBASSADOR HOTEL, PARK AVENUE, NEW YORK
WARREN & WETMORE, ARCHITECTS

6.22.31

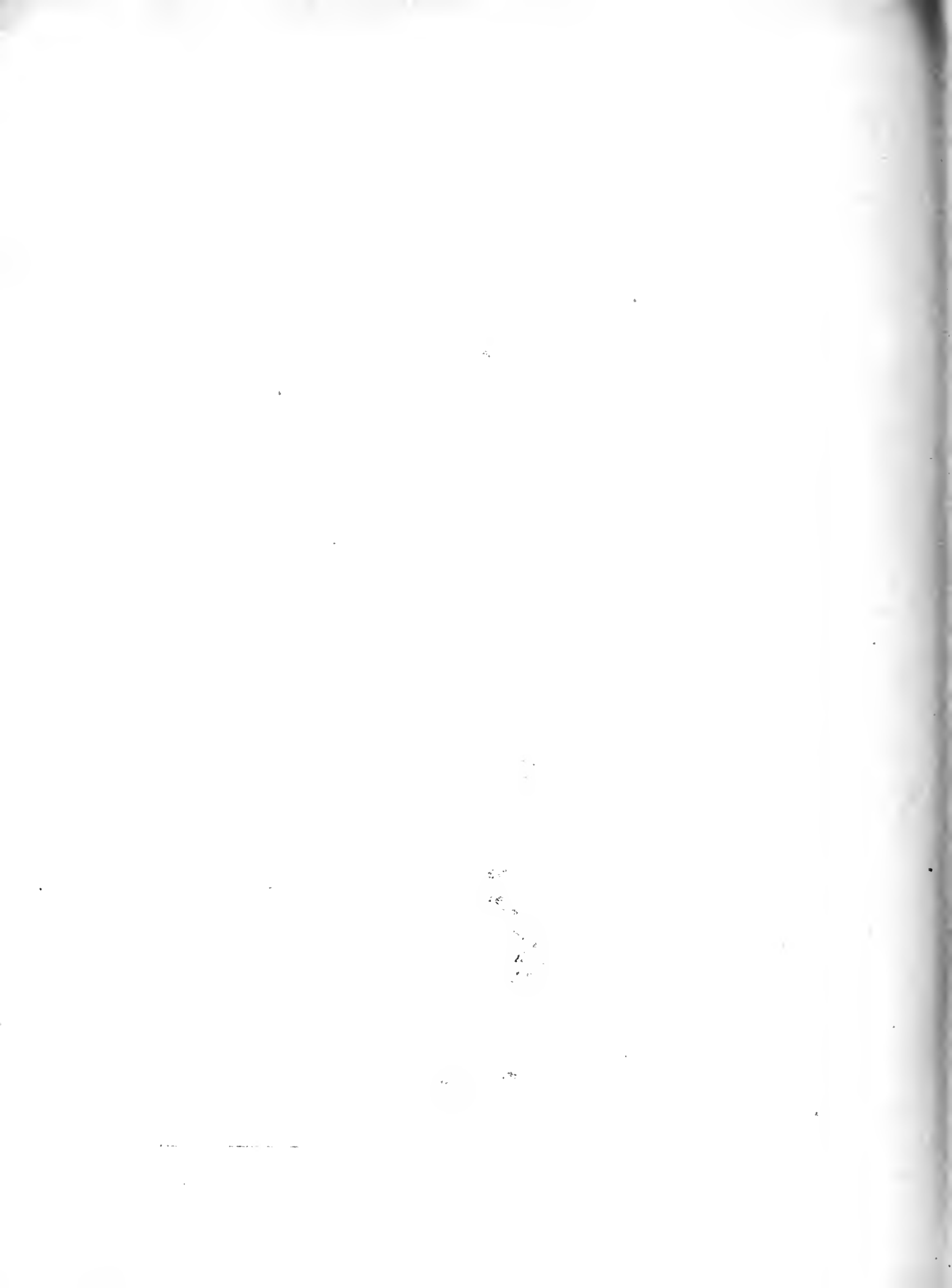

650 11

THE AMBASSADOR HOTEL
PARK AVENUE
NEW YORK

WARREN & WETMORE
ARCHITECTS

GROUND FLOOR PLAN

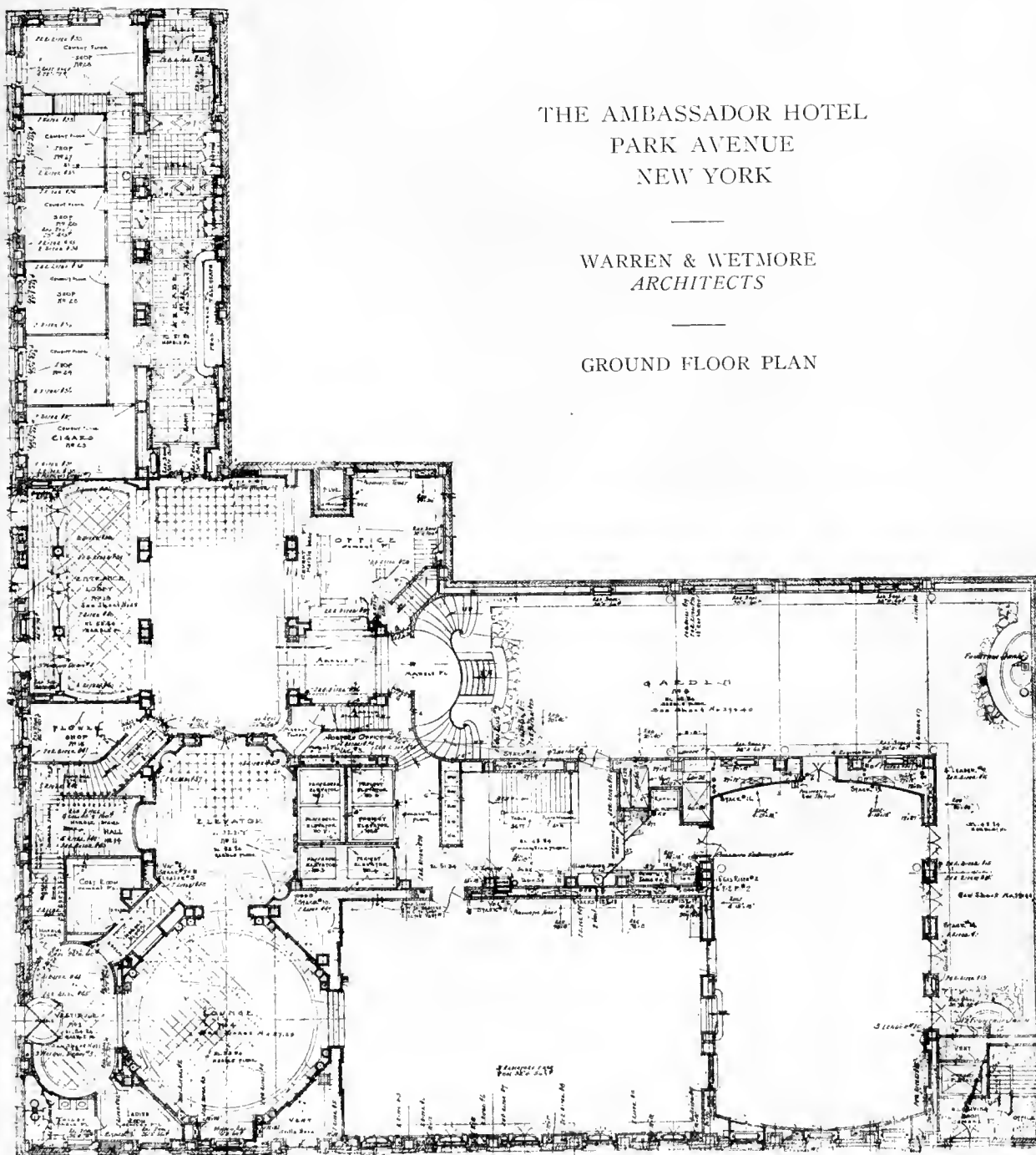



65012

WARREN & WEITMORE
ARCHITECTS

FOURTEENTH AND FIFTEENTH
FLOOR PLAN

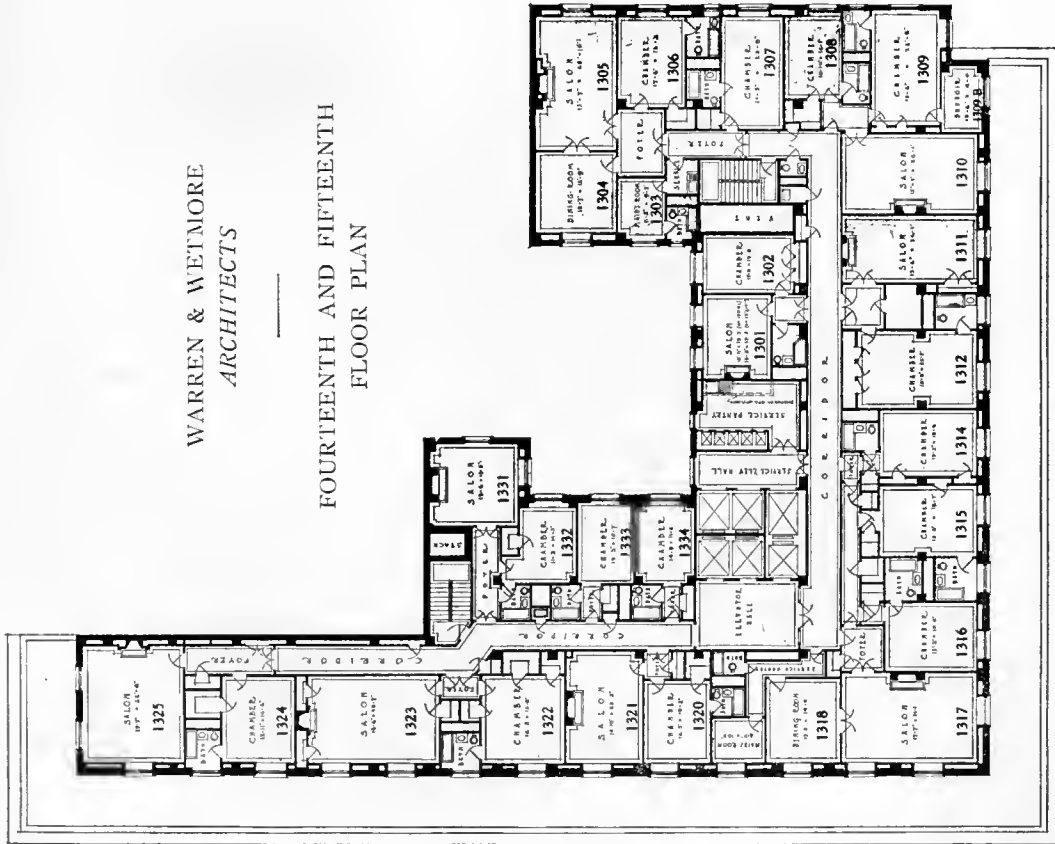

THE AMBASSADOR HOTEL
PARK AVENUE
NEW YORK

SECOND TO TWELFTH FLOOR PLAN

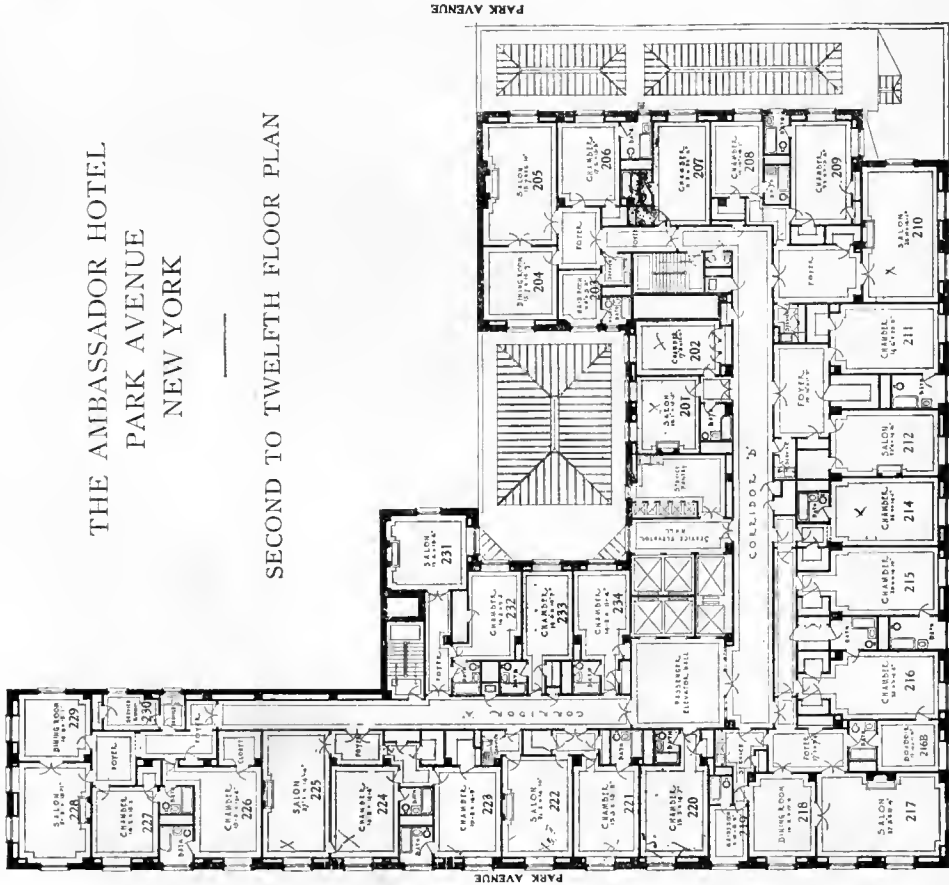



WARREN & WETMORE
ARCHITECTS

SEVENTEENTH FLOOR PLAN



650'0"

THE AMBASSADOR HOTEL
PARK AVENUE
NEW YORK

EIGHTEENTH FLOOR PLAN

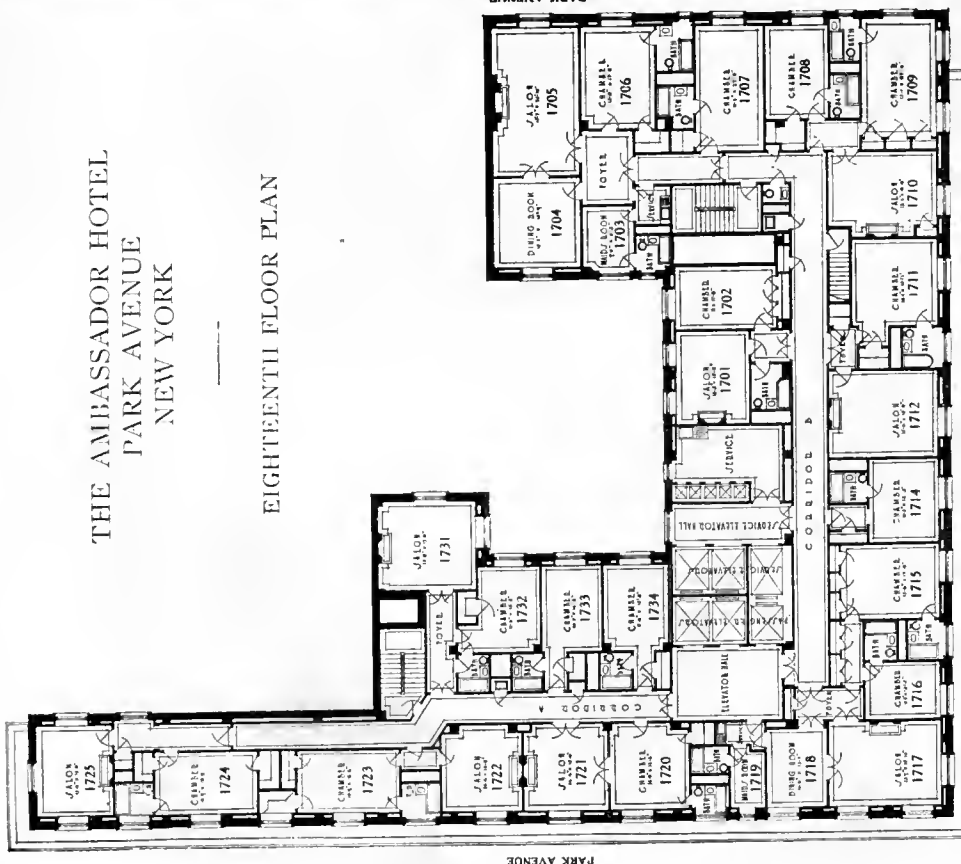

PARK AVENUE

PARK AVENUE

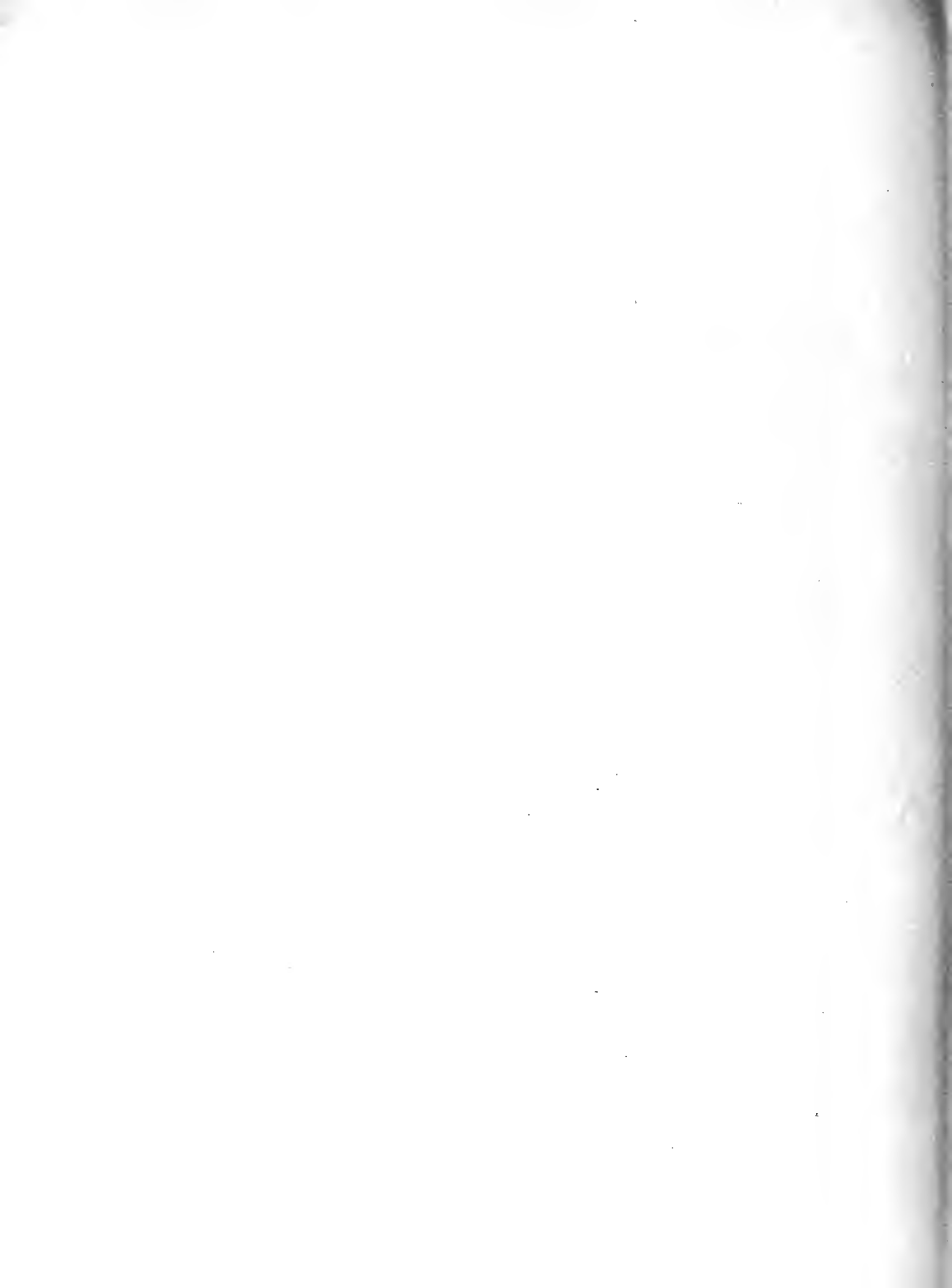



THE ARCADE
THE AMBASSADOR HOTEL, PARK AVENUE, NEW YORK
WARREN & WETMORE, ARCHITECTS



6



A PRIVATE DINING ROOM



MAIN DINING ROOM

THE AMBASSADOR HOTEL, PARK AVENUE, NEW YORK
WARREN & WETMORE, ARCHITECTS



TYPES OF DRAWING ROOMS IN PRIVATE SUITES, SHOWING VARIED DECORATIVE TREATMENT IN PERIOD STYLES

THE AMBASSADOR HOTEL
PARK AVENUE
NEW YORK

WARREN & WETMORE, ARCHITECTS

630 16.

THE AMERICAN ARCHITECT

will pay investors to build and will aid in bringing about a general resumption of building operations.

Your associations must know that these are abnormal times and that construction work will generally only be started when investors and builders are convinced that they can secure a reasonable return for every dollar invested and when they can

secure a day's work for a day's pay at a wage rate that is believed to be fair and equitable.

Respectfully submitted,

The Board of Directors of
The Illinois Society of Architects.
By F. E. DAVIDSON, *President*.

BEAUX-ARTS INSTITUTE of DESIGN

DIRECTOR OF THE INSTITUTE, LLOYD WARREN

ARCHITECTURE, RAYMOND M. HOOD
INTERIOR DECORATION, ERNEST F. TYLER

SCULPTURE, JOHN GREGORY
MURAL PAINTING, ERNEST C. PEIXOTTO

Official Notification of Awards—Judgment of January 25th, 1921.

PROGRAM

CLASS "B"—II ANALYTIQUE

The Committee on Architecture proposes as subject of this Competition:

"A WINDOW WITH A BALCONY"

In a War Memorial Building the second floor, i. e., the one directly above the entrance is the principal floor of the building. On this floor, opening on the main facade, is a large community room with a small reception room at either end. These reception rooms are expressed in elevation by

AWARDS:

First Mention Placed: E. Kaeyer, Columbia University, N. Y. C.; C. F. Bieler, Atelier Denver, Denver.

First Mention: L. H. Schofield, John Huntington, Polytechnical Institute, Cleveland.

Mention: E. F. Kennedy, E. F. Allodi, J. H. Shea, G. M. Burch, G. R. Marshall, L. A. Whelan, E. Weston, T. F. McDonough and I. L. Hyland, Boston Architectural Club, Boston; H. P. Baumann, Birmingham Y. M. C. A., Bir-

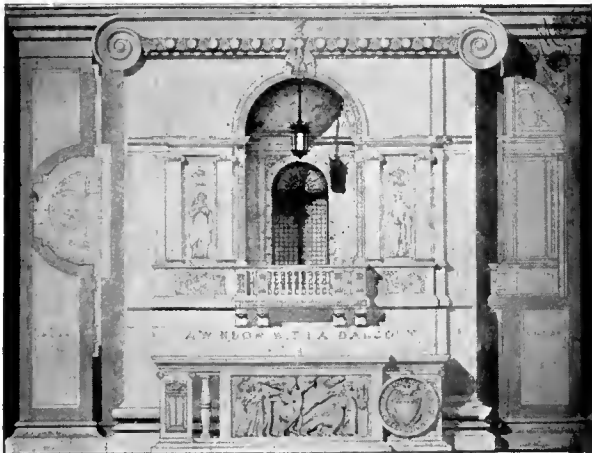

FIRST MENTION PLACED

E. KAEYER COLUMBIA UNIVERSITY
CLASS B-II—ANALYTIQUE
A WINDOW WITH A BALCONY

end pavilions in each of which a window with a balcony forms the chief motive.

The treatment of the window frame, whether with columns or pilasters, or with moulded or ornamental members is optional, as is also the treatment of the wall surface in which it occurs. The masonry opening of the window shall not exceed 7 feet. Its height is not determined, but the story in which it occurs is 20 feet high in the clear.

Examples of a similar window treatment may be found in the Palace of the Louvre in Paris, and in many of the Italian palaces.

JURY OF AWARD:

H. O. Milliken, F. A. Godley, E. J. Kahn, W. E. Shepherd, Jr., E. A. Park, J. F. Harbeson and A. E. Flanagan.
NUMBER OF DRAWINGS SUBMITTED: 141.



FIRST MENTION PLACED

C. F. BIELER ATELIER DENVER
CLASS B-II—ANALYTIQUE
A WINDOW WITH A BALCONY

STUDENT WORK
BEAUX-ARTS INSTITUTE OF
DESIGN

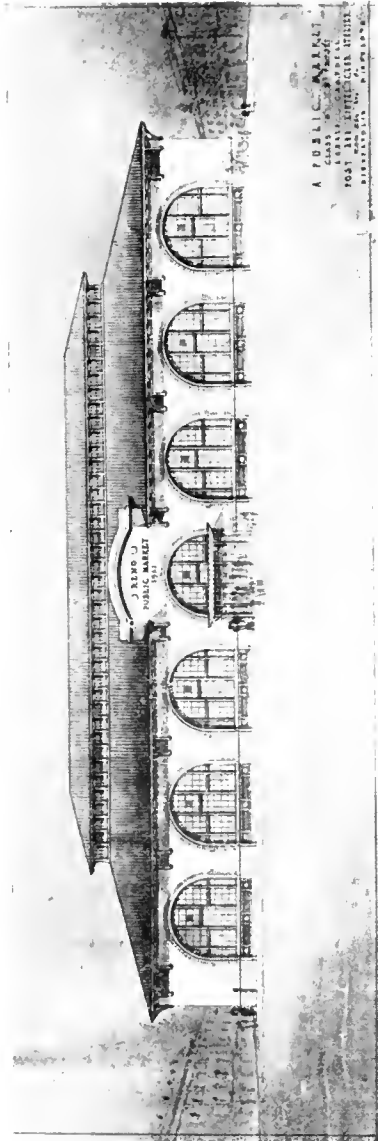
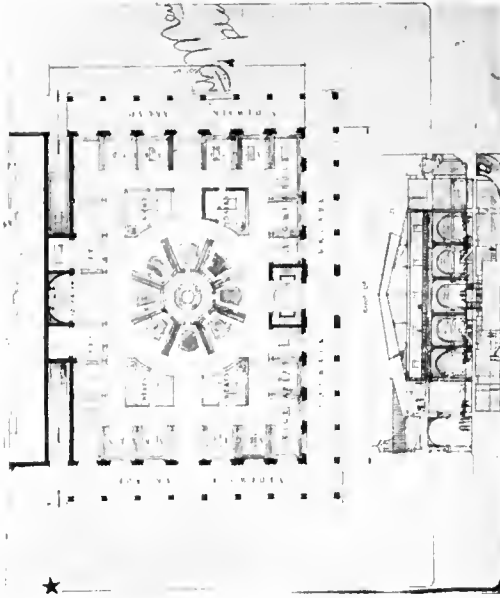

CLASS "B"—II PROJET
A PUBLIC MARKET

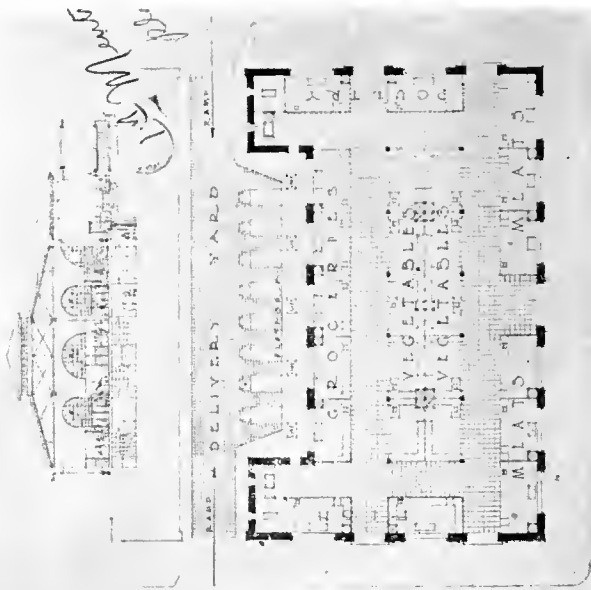

FIRST MENTION PLACED
POST & LINTEL CLUB P. H. GIDDENS

D. CAMPBELL

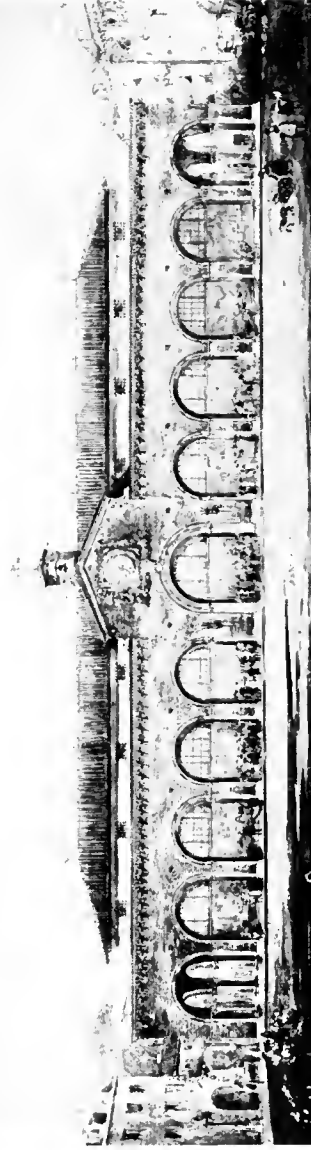

A . P V B L I C . M A R K E T . P L A C E

FIRST MENTION PLACED

ATELIER HIRONS

THE AMERICAN ARCHITECT

mingham; I. Tron, J. M. Paul, Myrtle P. Dyke and A. A. Ehrenrich, Columbia Univ., N. Y. C.; J. J. Keil, C. A. Brink, M. D. Smith, L. C. Page, F. B. Smith, R. H. Snyder, J. M. Lanese, J. H. Delo, L. L. Broida, E. M. Russell, C. C. Agee, G. A. Fister, H. H. Lefkowitz, P. F. McLean, P. C. Reed, C. F. Bowers, C. J. Billmeyer, P. Hohorst, J. W. Fritz, H. S. Torbett, H. L. Carter, J. S. Wood, M. C. Bert, V. H. Stromquist, H. A. Page, A. Schoepf and R. Patterson, Carnegie Inst. of Tech., Pitts.; W. R. Furey, Catholic Univ., Wash., D. C.; V. Pribil and C. J. Jensen, Atelier Corbett-Gugler, N. Y. C.; W. H. Speer, Atelier Denver, Denver; H. B. Rightmaire and G. H. Brockow, Atelier Davis, Los Angeles; E. W. Cappelmann, Georgia Sch. of Tech., Atlanta; W. Harris, George Washington Univ., Wash., D. C.; J. W. Hanson, Atelier Hiron, N. Y. C.; F. Sakata, L. A. Balicki, J. Delmissier, Y. Machacek, H. P. Whitworth, W. A. Jager, E. Horley, D. Nisnosky and G. S. Johnston, John Huntington Poly. Inst., Cleveland; H. Silverman, Atelier Licht, N. Y. C.; F. A. Eastman, Los Angeles Archl. Club, Los Angeles; J. Garry, 644 8th Avenue, N. Y. C.; T. R. Keating, Albright Art Gallery, Buffalo; A. R. Brown, E. Gylleck, G. M. Nedved, T. Ross, Jr. and E. Norling, Atelier Parsons-Chic. A. C., Chicago; E. W. Niblet, F. M. Garey, L. C. Palmer and E. R. Gilbert, Richmond, A. C., Richmond; H. A. King and R. G. Ten Broeck, Syracuse Univ., Syracuse; F. Raudenbush, W. H. Lewis and C. A. Langzettel, "T" Square Club, Phila.; A. A. Graves, Jr. and K. Schwinley, Univ. of Kansas, Lawrence; P. E. Isbell, A. G. Clay and V. M. Reynal, Yale Univ., New Haven.

PROGRAM

CLASS "B"—II PROJET

The Committee on Architecture proposes as subject of this Competition:

"A PUBLIC MARKET"

On a level rectangular plot 200 ft. by 150 ft. in size, as formed by the intersection of three important streets, it is proposed to erect a public market. One of the long sides of the property abuts the adjoining property.

Meats, fish, vegetables, etc., will be on sale in stalls, which should be conveniently disposed to accommodate the buyers. The majority of the stalls should have approximately 400 sq. ft. of floor area and they should all be carefully studied for ample light and ventilation.

The basement, containing the storage space and a refrigerating system, supplying the ice-boxes and refrigerators in the various stalls, should be provided with ramps or other means of connection with the street, so that the meats and produce may be delivered without interference with the public. Individual lifts or stairs shall connect the storage spaces of the basement with the stalls on the main floor. Only one floor besides the basement is required although this floor may be mezzanined in parts, if desired, to provide offices for the management and service of the building.

The facade should express the character of building, not only in its forms, but also in its use of materials.

JURY OF AWARD:

R. M. Hood, J. T. Haneman, J. H. Freedlander, W. S. Wagner, E. V. Meeks, F. C. Hiron, H. W. Corbett, A. C. Jackson and D. D. Ellington.

NUMBER OF DRAWINGS SUBMITTED: 91.

AWARDS:

First Mention Placed: C. Fuller and J. Aronson, Columbia Univ., N. Y. C.; P. H. Giddens, Atelier Hiron, N. Y. C.; D. Campbell, Post and Lintel Club, Minneapolis.

First Mention: A. K. F. Volmer and A. Marshall, Columbia Univ., N. Y. C.; C. B. Marks, and L. B. Christman, Carnegie Inst. of Tech., Pitts.; R. Linder, Atelier Denver, Denver; H. Van Der Lyn, Atelier Hiron, N. Y. C.; A. E. Evans, Univ. of Kansas, Lawrence.

Mention: H. H. Price, M. E. Witmer and J. Bush-Brown Boston A. C., Boston; F. L. Ford, Atelier Corbett-Gugler, N. Y. C.; A. M. Taylor, K. Matsunoi, F. E. Sims, R. T. Morenus, A. T. Saxe, F. L. Hutchins, H. J. Hoefener and O. W. Wilson, Columbia Univ., N. Y. C.; H. C. Douden, W. M. Burke, L. H. Rank, F. H. Floyd, J. G. Todd, A. W.

Chesterman, N. P. Rice, F. M. Highberger, H. E. Rudy, C. J. Pellegrini, L. Nusbaum, W. T. Spann, C. Landefeld, F. W. Klee, A. Taormina, J. C. Topnick, H. C. Kreisle, T. G. Tiffany, E. Hughes and W. L. Gibb, Jr., Carnegie Inst. of Tech., Pitts.; T. J. Rowland and G. A. Daidy, George Washington Univ., Wash., D. C.; G. H. Gibson, W. A. Robison and H. M. Burnham, Georgia Sch. of Tech., Atlanta; K. Sasagawa and S. M. Palm, Atelier Hiron, N. Y. C.; K. G. Koltukian, John Huntington Poly. Inst., Cleveland; W. W. Mezger and V. B. McClurg, Los Angeles A. C., Los Angeles; P. Goodman, Atelier Licht, N. Y. C.; W. K. Macomber, Post and Lintel Club, Minneapolis; T. J. Logan, Portland A. C., Portland, Ore.; R. E. Dando, E. L. Kennedy, G. S. Beach, K. Cheetham and J. Schierhorn, Atelier Parsons-Chic. A. C., Chic.; H. F. Neville, R. R. Hibbs, and R. B. Bloomgarten, Univ. of Kansas, Lawrence; B. S. Georges, C. B. Lewis, D. M. Campbell and H. S. Kelly, Yale Univ., New Haven.

H. C.; J. E. Linnett, Boston A. C., Boston; P. Simonsen, Columbia Univ., N. Y. C.; R. N. Hazelwood, Post and Lintel Club, Minneapolis; D. Weinstein, Yale University, New Haven.

Building in Holland

FOR the first time the erection of portable wooden houses for permanent occupancy has commenced in the Netherlands. A building society in Rotterdam has imported five houses from Austria, which it has erected near the plant of the Rotterdam Drydock Co. for the use of the employees of the latter company, and has ordered 20 more of a similar kind. The houses erected cost from 3,250 to 3,300 florins (\$1,083 to \$1,100 gold at present exchange). The others ordered are to cost from 3,400 to 3,500 florins (\$1,133 to \$1,166) each. Each house is substantially built and is well ventilated, contains a sitting room of 16 square meters (square meter = 10.76 square feet), three sleeping apartments, and has a total inside area of 47.85 square meters. The houses are arranged for one family each, and have been erected in connection with a "garden village" or model tenements owned by the same concern and made up of typical Dutch dwellings.

Practically nothing has been done in the way of the erection of wooden dwellings in the Netherlands, especially buildings of this sort. During the war wooden barracks for soldiers and interned troops, as well as for emergency hospitals and the like, were constructed from material obtained locally, but practically all buildings for permanent occupancy are constructed of brick, stone, or concrete. This has been due partly to the comparatively high cost of wood, most of which must be imported, as well as to the nature of the climate and the policy of building authorities. So long as the present exchange situation exists, it is hardly likely that American lumber interests can compete with Austria or Germany in these lines. The demand for houses in the Netherlands, both for workmen and for the public generally, is such that considerable attention must be paid to such construction in the immediate future.

DEPARTMENT OF ARCHITECTURAL ENGINEERING

REFRIGERATION Part Three*

By CHARLES L. HUBBARD

PIPING ARRANGEMENTS IN STORAGE ROOMS

There are various ways of arranging the cooling pipes in refrigerators and cold-storage rooms, depending upon the size and service required. The simplest plan is to hang the coils along the walls, or near the ceiling when it is desired to keep the walls free for shelves or other storage arrangements. A method frequently employed in markets, stores, restaurants, etc., where it is desired to maintain a moderately cool temperature during the night without running the compressor, is illustrated in Fig. 20. In this case the expansion coils are placed in tanks filled with brine which is chilled to a very low temperature. This is similar in effect to charging the refrigerator with ice and will maintain suitable storage conditions

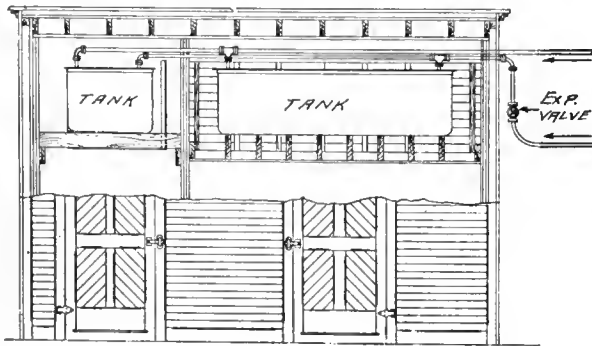

FIG. 20

for periods of considerable length, depending upon the relative sizes of tank and refrigerator. In other cases a solution of calcium chloride is used instead of brine, and this is frozen, thus making the conditions actually the same as though ice were used during the night. When the coils are hung along the walls of a room of considerable size there is not usually sufficient circulation of air properly to equal-

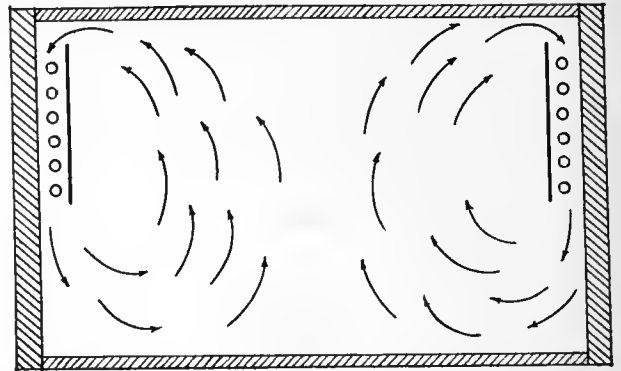

FIG. 21

ize the temperature. This may be improved by providing a light partition in front of the coils, as shown in Fig. 21, thus producing a flue effect and increasing the circulation as indicated by the arrows. A similar arrangement, adapted to overhead coils, is shown in Fig. 22.

In the "bunker" system, the cooling surface is massed in a single coil placed in a chamber above the storage room and the air caused to pass over it by means of suitable ducts, as illustrated in Fig. 23.

In the "indirect" system an apparatus is used similar to that employed in hot-blast heating, except ammonia gas or cold brine is supplied to the coil instead of steam. Air circulation is produced by a fan which draws its supply from a perforated ceiling duct (see Fig. 24), passes it through the coil, and

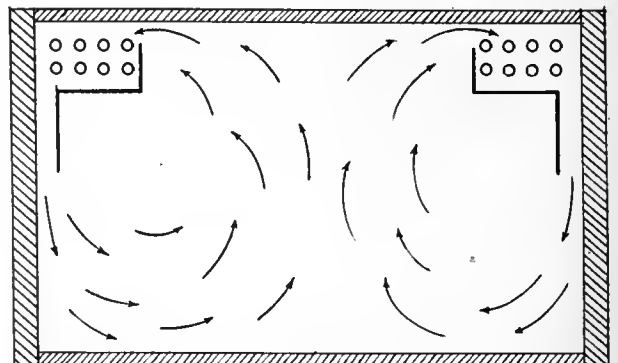

FIG. 22

*Part I appeared in issue of April 27; Part II in issue of May 25.

delivers the cold air to the room through ducts near the floor. For ordinary storage temperatures, with direct cooling surface, as in Figs. 21 and 22, it is customary to allow about 50 square feet of coil surface per 1,000 cubic feet of space for brine, and 25 to 30 feet for direct expansion. With the bunker system this may be reduced to 30 square feet for brine and 15 to 20 feet for direct expansion.

INSULATION

The insulation of cold-storage rooms is a matter of much interest to the architect and one

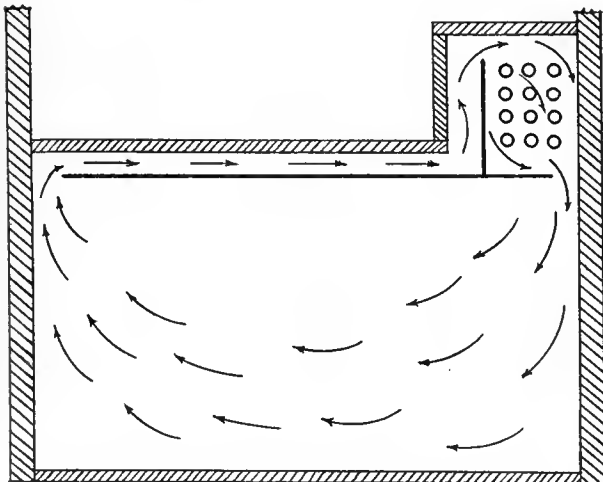

FIG. 23

which should receive careful attention. While a considerable initial saving may be made by using a cheaper form of construction, the cost of operation will be inversely proportional to the cost of insulation, and as the transmission of heat goes on continuously any saving due to cheaper construction will soon be offset by the increased cost of refrigeration necessary to balance the greater transmission of heat to the cold room. There are many different methods employed in construction of this kind, a number of which are shown in Figs. 25 to 28. These have been successfully employed by one of the large manufacturers of refrigerating machinery and may be used as a guide in the design of new work. The filling employed between joists in the wooden construction,

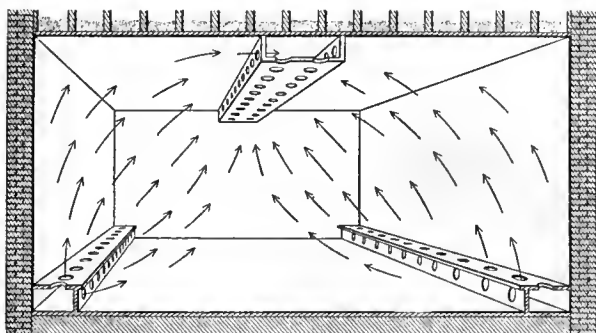

FIG. 24

shown in Figs. 25 and 26, is mineral wool. This makes a durable and satisfactory dry filling, but may be replaced by granulated cork if desired, a material which has also proven very satisfactory for work of this kind when properly packed. The first two cuts

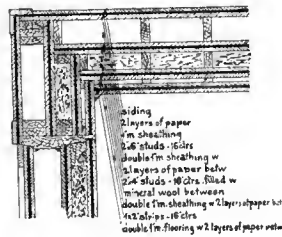

FIG. 25

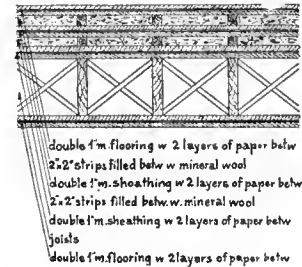

FIG. 26

show methods of insulating walls and ceilings, respectively, in buildings of wooden construction, and the second two, similar methods for fireproof construction. Figs. 29 to 34 show details of insulation made up of cork board, asphalt, and cement, which represents one of the highest grades of construction. In this case the cork is depended upon chiefly for insulation, while the other materials are principally for

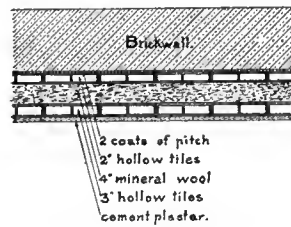

FIG. 27

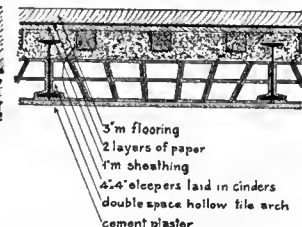

FIG. 28

waterproofing, strength, and to give a suitable wearing surface. The proper thickness of cork board in any given case will depend upon the character of the building construction, thickness of walls, ceilings, temperature to be maintained, climatic conditions, character of material to be stored, and cost of refrigeration. For average conditions, the following table may be used in the absence of more definite information:

Inside temperature to be maintained	Thickness of cork board
— 10 deg. to + 5 deg.	6 inches
5 deg. to 20 deg.	5 inches
20 deg. to 32 deg.	4 inches
32 deg. to 45 deg.	3 inches

In the diagrams given, 4 inches of cork board have been shown in each case, which may be changed to meet other conditions.

Referring to the drawings, Fig. 29 shows the insulation of a wall or ceiling of wooden construction; Fig. 30, a wall or ceiling of fireproof construction; Fig. 31, floor insulation on wooden construction; Fig. 32, floor insulation on fireproof con-

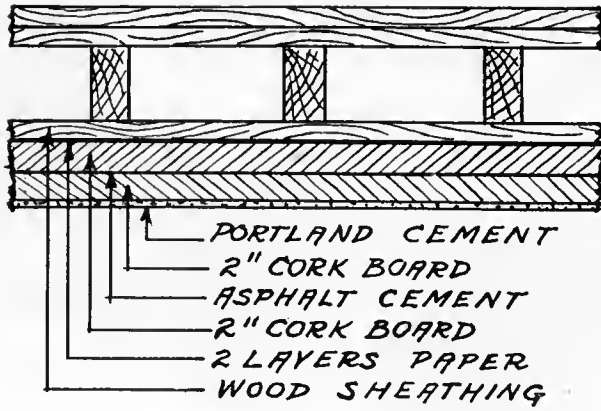

FIG. 29

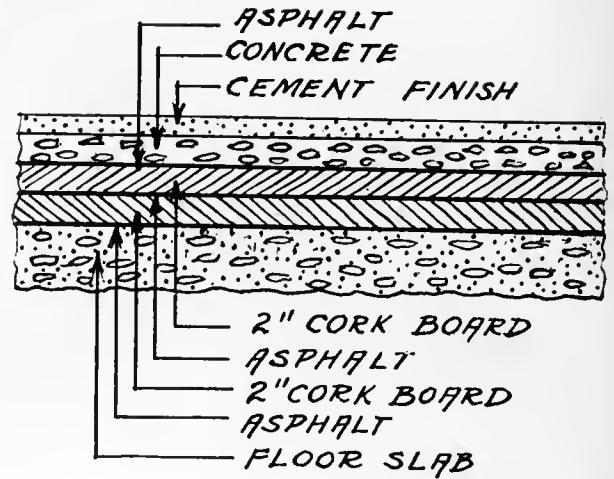

FIG. 32

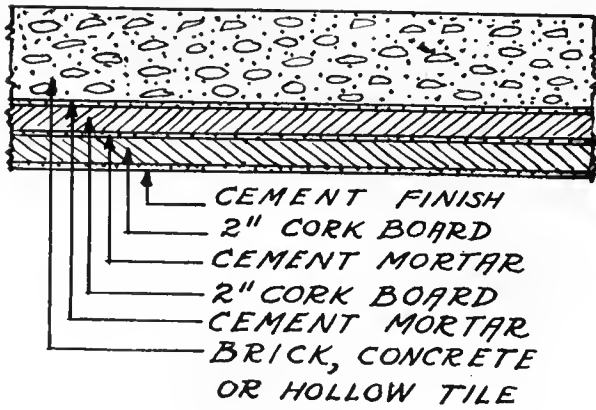

FIG. 30

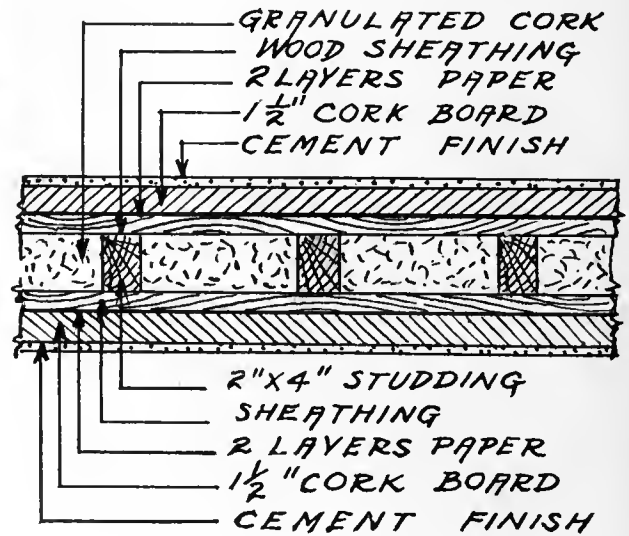

FIG. 33

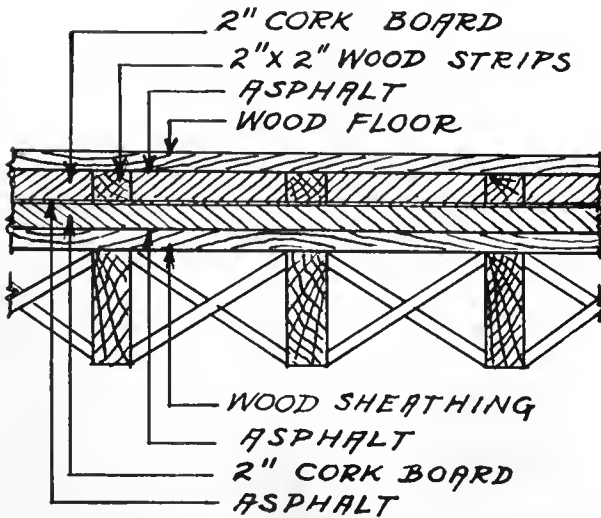

FIG. 31

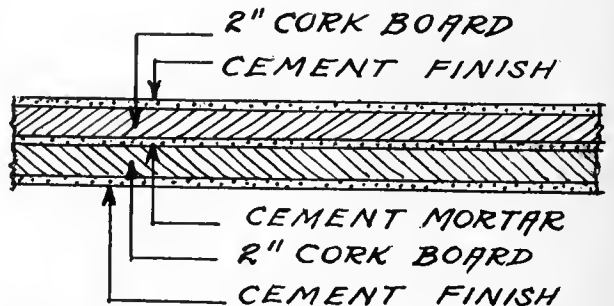

FIG. 34

ILLUSTRATING VARIOUS TYPES OF FLOOR INSULATION

struction; Fig. 33, the insulation of a wooden partition, and Fig. 34, a partition constructed entirely of cork board and cement. The above are only a few of the combinations which may be made of these materials.

WATER COOLING

This is an important application of refrigeration in hotels, apartment houses, office buildings, industrial plants, etc., and should be briefly described in the present article. While different arrangements of equipment are used for this purpose, the general scheme shown in Fig. 35 is commonly

from 1/2 to 1 gallon of water per person per day, which includes that drunk and wasted. The lower figure may be taken for hotels, office buildings, etc., while in shops and factories, where the work is of an active nature, the larger amount should be provided for.

The greater part of the refrigeration required for a water-cooling system is for offsetting the heat transmission through the distributing pipes rather than for cooling the water actually consumed. If the water is circulated at an average temperature of 50 degrees, through pipes insulated with a good

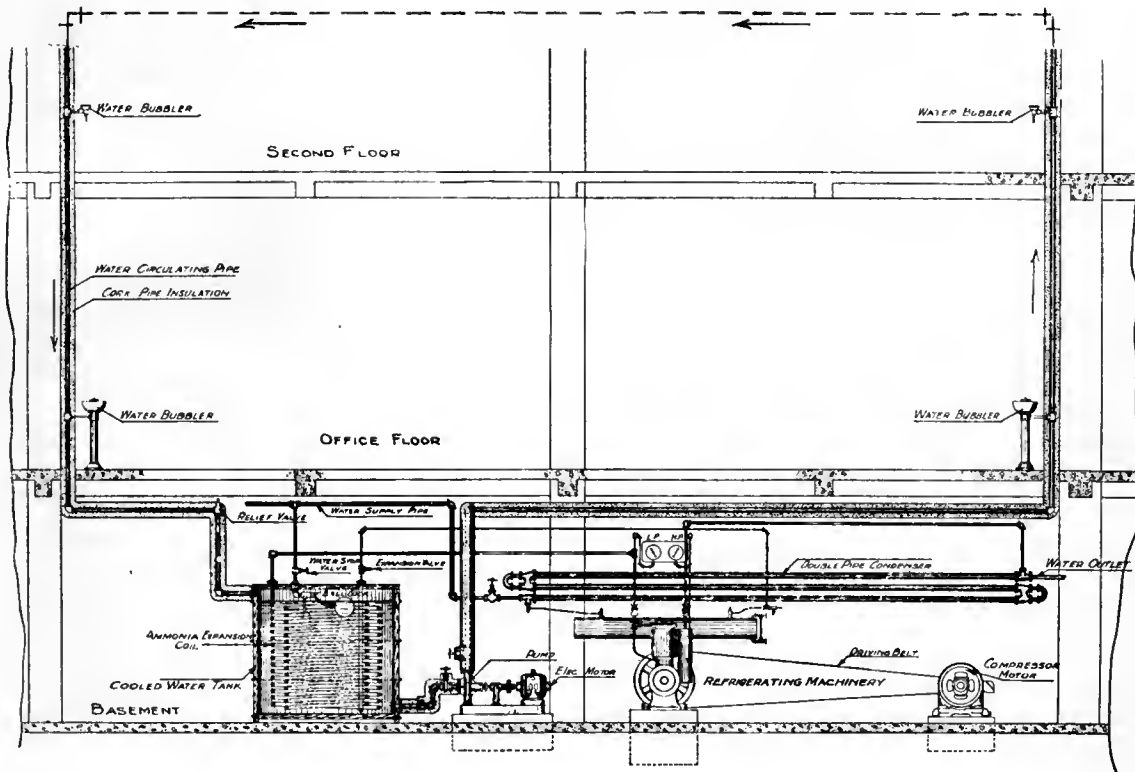

FIG. 35

made use of. This may consist of a small self-contained refrigerating machine connected with a direct-expansion coil located in the cooling tank, or the liquid ammonia may be taken from the receiver of a machine used for general refrigerating purposes in case of a hotel or other building where such a source is available. A constant water level is maintained in the tank by means of a float valve, which admits a sufficient amount automatically to replace that used or wasted at the fountains. Continuous circulation is maintained, as indicated by the arrows, by means of a small electric pump, so that the temperature of the water is practically uniform throughout the building at all times. The cooling plant should be centrally located, if possible, and all pipes well insulated with a good grade of sectional covering to reduce the amount of refrigeration to a minimum.

In systems of this kind it is customary to allow

grade of covering, the heat transmission from the air to the water will amount to about 8 T.U. per square foot of pipe surface per hour for an air temperature of 70 deg.; 12 T.U. for 80 deg.; and 16 T.U. for 90 deg. Example: An industrial plant, having 500 operatives, is supplied through a drinking-water system having 800 square feet of surface in the distributing pipes, which are covered. What refrigerating capacity will be required per hour for maximum conditions, with an inside temperature of 90 deg.? And what should be the rated capacity of the machine, in tons, per 24 hours?

Solution: On a basis of 1 gallon of water per person per day it will require 500 gallons or $500 \times 8.3 = 4,150$ pounds. If this is cooled from 65 to 50 degrees, it will require the withdrawal of $(65-50) \times 4,150 = 62,250$ T.U. per day, or $62,250 \div 8 = 7,781$ T.U. per hour. The heat transmission through

the distributing pipes for the assumed conditions is $800 \times 16 = 12,800$ T.U. per hour, making a total of $7,781 + 12,800 = 20,581$ T.U. to be absorbed per hour. The melting of 1 pound of ice requires the absorption of 14.4 T.U., hence a refrigerating capacity equal to $20,581 \div 144 = 143$ pounds of ice per hour will be required. This, for 8 hours, will

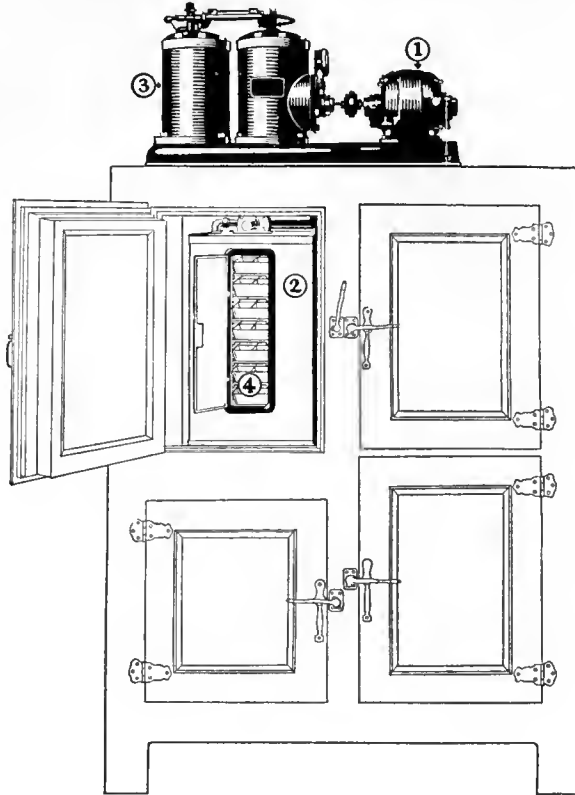

FIG. 36

be $143 \times 8 = 1,144$ pounds, or $1,144 \div 2,000 = 0.572$ tons. As this amount of refrigeration must be produced in 8 hours, the rating of the machine

$$\text{per 24 hours must be } \frac{24}{8} \times 0.572 = 1.7 \text{ tons.}$$

AIR COOLING

Unless water from deep wells or city mains, at a temperature of 50 to 55 degrees, is available for producing the spray in an air washer, any cooling effect will be brought about by evaporation and the air will have so high a degree of humid-

ity as to prove exceedingly oppressive at temperatures of 70 degrees or more. City water is too expensive, and well water, even when available, usually involves a considerable outlay for drilling and the installation of suitable pumping machinery.

The conditions sought may be secured by recirculating the spray water, and cooling it either by placing an ammonia or brine coil between the spray chamber and eliminators or passing it through an outside cooling tank. The former plan is more frequently used, being somewhat simpler and also cooling the air to some extent by direct contact. This arrangement forms part of the air washer equipment and is usually installed by the makers when cooling is desired. Devices of this kind are frequently employed in hospitals, dining-rooms and restaurants, banking rooms, and in certain industrial plants, like candy factories, where special processes make it necessary to limit the room temperature.

HOUSEHOLD INSTALLATIONS

A type of refrigerating equipment particularly adapted to dwellings and apartments is illustrated in Fig. 36. The machine is motor-driven and commonly mounted upon the top of the ice box. The compartments are provided with small brine tanks through which the expansion coils pass, the amount of surface depending upon the temperature it is desired to carry in the compartment. In the machine illustrated, the brine tank for the entire refrigerator is placed in the upper left hand corner and takes the place of the usual ice supply. Referring to the cut, (1) is the motor, directly connected with the compressor at the left; (2) is the brine tank; (3) the condenser; and (4) a compartment in the brine tank for freezing small cubes of ice for table use. Machines of this type are automatic, the motor being stopped and started by changes in the temperature. It is desirable that they operate at comparatively low pressure and that the gas be harmless in case of leakage. For these reasons either sulphur dioxide or ethyl-chloride are commonly employed, as both of these gases meet the requirements. The machine is charged with the refrigerant and the proper amount of lubricating oil at the shops, and sealed, so that no further attention is required on the part of the user. Tests are on record where machines have run continuously without repairs for periods equivalent to over ten years of normal operation.

The Ambassador Hotel and the Architectural Engineer

IT is in the design of a large modern hotel and the arrangement of machinery and appliances for the comfort of the guests, that the work of the architectural engineer is shown to the best advantage.

Consider, for example, the New York Ambassador Hotel with its 600 chambers and about 500 employees. See the parallel, nearly one employee per room. It is said that in modern hotels there is practically one employee for each guest, so the man who plans the equipment by means of which this vast machine will function properly has no mean task.

THE ARCHITECTURAL ENGINEER

IT is the architectural engineer who has the task. He receives from the architect the plans for a building in which convenience, utility and good taste have been duly considered. Accompanying the plans are the specifications for materials and workmanship. It is his part to design the supporting framework and provide all things necessary so the structure will function properly. It is a pity, in fact, that he must minister to and there is a close analogy between the work of the architectural engineer and the municipal engineer.

Time was when the structural designer was called an architectural engineer, but today it is not so; he is merely an assistant. The position of the architectural engineer in relation to the architect resembles nothing so much as the Chief of Staff to a General.

The people in the hotel must be not only housed but they must be comfortably housed. Their apartments must be warm in cold weather, and cool in hot weather. The air must be changed often enough to preserve freshness and prevent lethargy. They must have ice water to drink, cold water and warm water in which to bathe, and the water must be clean and look clean. Drainage must be provided for all wastes. The lighting must be agreeable and sufficient and include not only artificial lighting but the lighting which is afforded by the windows supplied in the design of the architect. Last, but not least, cleanliness must be considered, not alone the cleanliness of the building but the laundry work for the rooms, the guests and the personnel. Power, heat, light, water supply, plumbing, ventilation; a group of words, perhaps, but a group which is pregnant with meaning to the owners. A failure in one may neutralize the effect of widespread advertising of the hostelry, which must be up-to-date. So the architectural engineer bears a heavy responsibility for his chief, the architect, who turns over to him the thousand and one technical details of the city under one roof.

STRUCTURE

THE foundations of the Ambassador Hotel go to bed rock. The frame work is of structural

steel, fireproofed. The floors are top slab cinder concrete construction resting on steel beams. No problems out of the ordinary were encountered in design or during construction. The walls are of brick and the ornamental stone work is almost wholly cast imitation limestone.

POWER, HEAT AND LIGHT

IN the basement of the Ambassador Hotel there are three large horizontal tube boilers, claimed to be the largest in New York City. The diameter is 78 inches and the length is 22 feet. Each boiler is covered top and sides and in addition the walls around them as well as the ceiling above are insulated so the boilers, normally operated under natural draft, may be run under forced draft with a minimum of discomfort from heat to people on the first floor as well as those employed in the basement.

The coal bunkers have a capacity of 350 tons of No. 2 buckwheat coal.

There are three 200 kilowatt geared turbine units. This is a somewhat new type of apparatus for use in hotels. They are very much smaller, cost much less and are claimed to be more efficient than the reciprocating units now generally used. Their installation in the Ambassador Hotel is in the nature of an experiment and will be watched with interest, for the square foot value of basement space is high.

The same manufacturers also installed seven ventilating fan motors, four pump motors, two air compressor motors and four vacuum cleaning motors, in addition to a switchboard and a number of safety lighting panels. The lighting panels are so designed that it is impossible for anyone operating them to come in contact with live parts. This is a great improvement over the ordinary type of panel with unprotected knife switches. The ventilating fan motors are of the slow speed direct-connected type, operating at the highest possible speeds without noise.

AIR COMPRESSORS

THERE are two 12"x8" N-SBE horizontal, single-belt driven compressors with short belt drive, each having a displacement of 314 cu. ft. of free air per minute against a discharge pressure of 40 lbs. per square inch. The electric motors operating the compressors are controlled by automatic starters and pressure regulators. The pressure governor shuts down the motor and stops the machine automatically when a pre-determined maximum pressure is reached. Conversely when the compressor has dropped to a pre-determined minimum, the pressure governor again acts to start up the motor. The compressors are fitted with an unloading system which permits them to start and stop with no load.

THE AMERICAN ARCHITECT

VENTILATION OF PUBLIC ROOMS

THE dining rooms and public assembly rooms are supplied with fresh air which passes over heating coils in cold weather and cooling coils in hot weather. Foul air is drawn off through the ceiling, the openings being concealed by the ornamental iron work from which hang electric light bulbs, forming part of the lighting scheme. The working of the ventilation system can be observed best when a number of smokers are seated at the tables, the smoke travelling in thin threads forming a diaphanous canopy which accentuates the ornamental effect of the lamp cluster support.

A UNIQUE SYSTEM OF VENTILATION FOR BATHROOMS

ALL bath rooms are ventilated by fans which exhaust the air. The air supply is drawn in beneath the doors, the exhaust and intake being so nicely balanced that no complaints of drafts have been received. The floors of the rooms are covered with thick carpets and the outward opening bathroom doors barely clear the surface so that no wear can be caused. This leaves a space of about three-quarters of an inch beneath each door, which space has been cleverly utilized as a part of the scheme of ventilation.

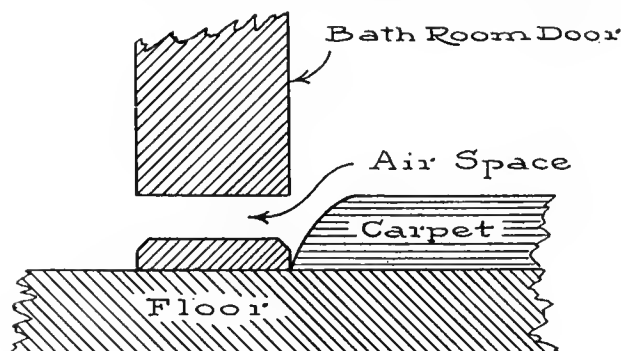

A WIRELESS OPERATED CLOCK

IN each room is an electrically operated clock, controlled by a master clock which is regulated each minute by wireless current from the Arlington Station. Even the numerous time stamps in the hotel are on this system.

"WATCH YOUR STEP" NOT HEARD IN AMBASSADOR ELEVATORS

THE three main passenger elevators are the new regulated micro self-leveling type, the first to be installed in New York City. When the operator

throws the stopping lever before the car floor is at the floor level, or after it has passed the floor level, a small magnet actuates a cam which sets another hoisting machine in operation. This machine being small moves the elevator very slowly and the up or down position of the cam determines the direction. When the floor of the car is exactly at the floor level the magnet leaves the cam and the car stops. Then, and not until then, the doors may be opened. Passengers are thus protected by a double safety device, one which does away with all danger of stumbling or tripping when entering and leaving the car and which also makes it impossible to open or close the doors of the elevator shaft until the car is in the "safe" position.

HOTEL NEEDS

TO keep this hotel city spick and span requires an odd job shop, paint shop, carpenter shop, furniture repair shop, plumbing shop, etc., manned by a staff of men representing practically every building trade. This in addition to the usual place for cleaning, pressing and repairing clothes. There is also a well equipped printing office in which is done the highest kind of work.

WATER AND ICE

TWO pressure filters purify every drop of water used in the hotel, for all purposes. Water is sent throughout the hotel by two general service electric house pumps of 75 H. P. each.

There are two ice machines which take care of the 75 ice boxes in the hotel and in addition can make 14 tons daily of ice in cakes, or an actual daily capacity of 50 tons of ice. All ice is made of distilled water, reboiled, cooled and filtered, for it is used in drinking water. There is a special brine line for freezing ice cream without the trouble of handling ice and salt. The ice cream storage boxes are also cooled by brine.

WASTES

ALL greasy liquids pass through a grease trap, there being a constant demand from manufacturers for the grease. The basement sump being about 30 feet below the level of the sewer, laundry and kitchen wastes, after being freed of grease, are lifted by three ejectors. All liquid wastes from higher levels flow directly to the sewer after being freed from grease. All garbage is destroyed in an incinerator in the main chimney stack.

The Rise and Run of Stairs

IN *Engineering News-Record*, May 12, 1921, Mr. Raymond C. Reese presented two interesting diagrams to use in proportioning the rise and run of stairs. He proposes the following formula:

$$\text{Rise} \times \sqrt{\text{run}} = 23\frac{1}{2}$$

as giving more consistent results than older formulas, for all values of the rise. The proportions required in the Cleveland Building Code he expresses as follows:

$$\text{Rise} = 25.4 \text{ run} - 0.5359$$

from which he derived the one above. Of the older formulas he found

$$2 \text{ rise} + \text{run} = 23 \text{ to } 25$$

gave a better balanced stair for widely varying values of the rise than the two following, which are in common use.

$$\text{Rise} \times \text{run} = 66 \text{ to } 75 \text{ (usually } 72 \text{ to } 75)$$

$$\text{and } \text{Rise} + \text{run} = 17 \text{ to } 17\frac{1}{2}$$

These latter have been in common use for many years, but give very steep stairs at the higher values of rise and very shallow ones for the lower values. For slopes of 18 degrees, or less, ramps would be used instead of stairs.

Colored Wall Plaster

THE desirability of colored wall plaster, containing a uniform tint throughout the depth and not requiring a skin of paint, paper or kalsomine, does not admit of argument. The coloring of plaster, without weakening it in any way, seems to have been solved by chemists of the U. S. Bureau of Standards, with one standard plaster material. Gypsum wood-fibered plaster consists of approximately 85 per cent of calcined gypsum, 14 per cent of plastic material such as clay or lime, and 1 per cent by weight of wood fiber. This 1 per cent by weight is about 15 per cent by bulk. The surface texture of the wall may be varied by varying the amount of wood fiber. The plaster is colored by the simple expedient of dyeing the wood fiber with aniline dyes. Plasters colored by this method will have "life." How it is accomplished is interestingly told in Bulletin No. 181, Technologic Papers, Bureau of Standards. It is sold for five cents by the Superintendent of Documents, Government Printing Office, Washington, D. C.

Effect of Colorings on Concrete Strength

IN a discussion of the paper on "Coloring Concrete," by John W. Lowell, presented at the recent annual meeting of the American Concrete Institute, Prof. Duff A. Abrams, of Lewis Institute, Chicago, made the following report of certain tests con-

ducted to determine the effect of coloring agents on the strength of concrete.

The accompanying table gives the averages of the compressive strengths of 3 x 6-in. cylinders, made of 1:2 mortar and tested at ages of 7 and 28 days. Portland cement was used; the aggregate was a coarse sand from Elgin, Ill. The percentages of coloring materials are in terms of the weight of the cement. Each value is the average of three tests made from a single batch of concrete. The tests on each color were made at different times; this accounts for the three values given in the third column for the mortars without coloring.

Coloring Material	Age at Test Days	Compressive Strength of Mortar Mixed with Different Percentages of Color, Lb. per Sq. In.					
		None	0.5	2	5	10 15	
		French's C. U. Blue.....	7	2,100	2,500	2,960
French's C. U. Blue.....	28	3,390	3,990	3,990	4,630	4,900
J. M. Wells Co. No. 2 Red.	7	2,790	2,750	2,590	2,450	2,270
J. M. Wells Co. No. 2 Red.	28	4,900	4,780	4,390	4,410	4,090
Cabot's Carbon Black.....	7	2,840	1,820	1,610	870	690
Cabot's Carbon Black.....	28	5,080	4,240	3,070	2,000	940

It will be seen that three different effects were produced: The blue appears to possess some hydraulic properties which caused it to show a steady increase in strength up to the highest percentage used (15 per cent. of the weight of cement) at both 7 and 28 days. The red color caused a slight reduction in strength which is practically the same as the effect produced by other inert powdered materials in concrete. The carbon black produced a very great reduction in strength; 2 per cent. of carbon black reduced the concrete strength about 40 per cent. Bancroft in "Applied Colloidal Chemistry," 1921, states that "with a substance like carbon black which absorbs gas very markedly, as little as 5 per cent. of the apparent volume may be due to the carbon black and a liter of carbon black may contain 2.5 liters of air." This peculiar property, no doubt, accounts for the effect on concrete shown by the tests.

Factory Construction for School Shop Buildings

MR. J. C. BESWICK, State Supervisor of Industrial Education, Sacramento, Cal., reports that in his state a number of high schools are erecting shop buildings of concrete. The size found most suitable, which he recommends as a standard, is 40 feet wide by 150 feet long. Factory construction is followed throughout; concrete floors and walls, steel sash, steel roof trusses, some one of the many types of approved roofing for industrial buildings. All interior partitions are of hollow tile or concrete blocks. As this type of partition is movable, it has been adopted because of the many changes in such schools due to introduction of new courses and changes in equipment.

Tabulation of Building Costs

Fifth of THE AMERICAN ARCHITECT'S series of cost tables, figures for which were furnished by Architects throughout the United States. The first compilation appeared in the January 12 issue

Type of Building	Location	Type of Construction	Equipment	Cost	Total cubic feet	Contract price or bid received	When figures were taken
Church	Holdrege, Neb.	Semi-fireproof.	Steam heat; electricity; plumbing.	Not stated.	\$56,310	May, 1921
Residence	18 mi. from Buffalo, N. Y.	Non-fireproof; hollow tile and stucco walls; wood joists.	Hot air (2 furn.); electric wires in iron conduits; 5 baths, high grade fixtures throughout.	Concrete walls, no footings.	43,119	Mar., 1921
School	Phoenix, Ariz.	Non-fireproof; brick walls; tile roof; wood floors; one story; small basement for heating plant.	Plenum heating; electric light; vitreous china plumbing fixtures.	Concrete.	350,000	70,000	April, 1921
Country Club	Phoenix, Ariz.	Non-fireproof; brick walls; tile roof; wood floor; concrete steps.	Gas heaters; electric lighting; plumbing.	Concrete.	233,277	40,379	April, 1921
Nurses' Home	Omaha, Neb.	Fireproof; brick walls.	Vapor heating; electric lighting; push button elevators.	Not stated.	260,000	120,000	May, 1921
School	Oxford, Neb.	Semi-fireproof; brick walls; wood sash; wood joists; fireproof stairs; fireproof floor over boiler room; 3 floors; excav. only for gym. and boiler room.	Vacuum steam heat; electric lighting; vitreous plumbing.	Not stated.	417,000	67,562	May, 1921
Residence	Boston, Mass.	Semi-fireproof.	Steam heat; electric light; good plumbing.	Concrete.	35,000	19,000	May, 1921
Office	Baltimore, Md.	Fireproof; steel frame; concrete floors; brick and stone walls; 7 stories to be ultimately 12-story bldg.	Steam heat; electric lighting; first-class plumbing; electric elevators.	Reinforced concrete.	573,311	573,000	May, 1921
Residence	Baltimore, Md.	Non-fireproof; stone walls with 2nd story in gambrel roof; wood floors.	Vacuum steam heat; electric light; 2 baths and 2 lavatories.	Stone.	65,170	43,000	Feb., 1921
Cottage, 1½ stories	9 mi. from Baltimore, Md.	Non-fireproof; stucco on brick walls; wood floors.	Hot water heat; electric light; 2 baths.	Concrete on stone.	38,215	18,000	Mar., 1921
Store	Huntsville, Ala.	Non-fireproof; brick walls; wood floors.	No heat; electric light; plumbing; hand power elevator.	Concrete.	50,000	5,000	May, 1921
Residence	Huntsville, Ala.	Non-fireproof; wood frame, metal lath, stucco walls; wood floors.	Hot air; electric light; plumbing.	Sandstone.	50,544	6,700	April, 1921
Residence	Huntsville, Ala.	Non-fireproof; wood frame, bishopric board, stucco walls; wood floors.	Hot air; electric light; plumbing.	Not stated.	56,142	8,200	Mar., 1921
Residence	Huntsville, Ala.	Non-fireproof; wood frame, bishopric board, stucco walls; wood floors.	Hot air; electric light; plumbing.	Not stated.	51,272	5,600	May, 1921
School	Wayzata, Minn.	Semi-fireproof; tile walls; concrete floors.	Steam heat; electric light; plumbing; water supply; sewage disposal.	Not stated.	870,830	222,000	Sept., 1920
Theater	Lawrence, Mass.	Non-fireproof; brick walls; wood floors.	Heat; light; plumbing.	Concrete.	April, 1921
Church	Brighton, Mass.	Non-fireproof; brick walls; wood floors.	Heat; light; plumbing.	Concrete.	April, 1921
Department Store	Boston, Mass.	Fireproof; steel and reinforced concrete; brick and stone walls; concrete floors.	Heat; light; plumbing, elevator.	Concrete.	May, 1921
Hotel	Boston, Mass.	Fireproof; steel and reinforced concrete; brick and stone walls; concrete floors.	Heat; light; plumbing, elevator.	Concrete on pites.	May, 1921



DETAIL OF UPPER STORIES

BUILDING FOR S. W. STRAUS & CO., FIFTH AVENUE AT 46TH STREET, NEW YORK
WARREN & WETMORE, ARCHITECTS

REVIEW of the CONSTRUCTION FIELD

With Reports of Special Correspondents in Regional Centers

The Building Outlook

THAT a fairly definite change for the better has taken place in the building industry can no longer be doubted. The Guaranty Survey, published by the Guaranty Trust Company of New York, reports a nation-wide increase in building activities, which for April exceeded those of any months since June, 1920. Contracts awarded in twenty-five Northeastern States aggregated more than \$220,000,000, the largest amount for April of any year except 1920, and 34 per cent. in excess of March. Contracts awarded in the New England States in April totalled \$17,800,000, an increase of 34.4 per cent. over March, and contracts awarded in the first four months of this year amounted to \$46,400,000, or 25 per cent. more than for the corresponding period in 1920. In New York and Northern New Jersey construction contracts in April aggregated \$51,000,000, an increase of 71 per cent. over March. In the Middle Atlantic States, April building contracts amounted to \$27,246,000, which represented a slight increase over the preceding month. In all sections of the country residential construction is reported to lead all other building, something to be expected, for, during the period 1914-1920 the United States failed to replace all homes destroyed and construction of new homes was retarded. Comparison of curves of actual construction with projected curves of normal construction reveals a shortage of approximately 1,500,000 homes. This means that for some years we will be occupied in making good the deficiency in addition to supplying the demand due to normal increase in population.

The next step is to make adjustments in the cost of all things entering into a house, of which labor is the most important item. There is no reason to be discouraged for the process of adjustment will follow precedent. The men who are going to build homes are those who have been held by their employers after passing through fiery financial trials. They feel secure in their jobs and consider that their savings may be prudently invested in a home. Many would not do this but for the high rents now prevailing, and which will prevail for some years to come.

THE general depression has set free a great deal of labor and the ranks of untrained labor fill each month with immigrants. The effect will be felt soon in the brick yards, the quarries, the forests and the mines in which production will increase in order

to get all possible benefit from prevailing prices. Increased competition brings a lowering of prices, for the law of supply and demand works independently of legislatures and courts. The railways will shortly be able to move goods at lower rates so the effect will be felt everywhere. The greatest retarding effect at the present time upon active resumption in building is the attitude of certain leaders of workmen in the building trades. That this drawback will disappear with the growing demand for the services of the men, together with a lessening of the cost of living no one doubts. We have nothing to worry about now for the tide has turned. Present labor costs are due solely to combination and not to worth or actual demand. The natural laws of competition due to supply and demand have been temporarily set aside. Since unemployment is expressed today in figures running into millions of men, the more needy may be expected to break shortly and the wheels of industry will again hum.

The capitalist class cannot be forced to stand all the blame for the present depression. So long as the banks granted credits freely the adventurous business men borrowed. Interest rates advanced and still men plunged. The check came from the employees who finally rebelled at high prices. They wished to hold on to the wages of 1920 and pay 1913 prices for the things they wanted. The expected happened. Deflation was necessary in view of the lessened demand for goods. No one bought anything except necessities and credit had to be curtailed. We are now suffering the results of such a policy. Thanks to the inability of the average human being to hold a sustained interest in anything for a long time the "buyers' strike" is ended. Interest rates having gone to a speculative point, checked loans and helped increase bank reserves. The price of money is gradually coming down, paralleling the slightly increased demand for all sorts of goods. The risk having been taken out of business all that remains to hinder wide spread improvement is the present attitude of labor, which, instead of being defiant now has an apprehensive appearance presaging a break.

THERE is work for all and it is a sad commentary on our lack of system in finance that today more than two million men are out of employment in the United States. Recent legislation eliminated the panic as a factor in the regulation of business. Yet this legislation merely corrected previous legislation which brought about the bad con-

THE AMERICAN ARCHITECT

ditions. The next great problem for financiers and students of economics will be the discovery of something which will make our profile of business conditions a rippling curve instead of a succession of crested peaks and sharp deep valleys.

In the meantime let the architect and builder take heart; statistics show that the outlook for building is rapidly improving. First the home, next the school, then the hotel, followed by the store and factory. We are now gazing on the promised land. Let us make our plans to enter upon our heritage in time for bountiful harvests next year and for several years to follow.

THE BUILDING SITUATION in CHICAGO and the MIDDLE WEST

(Special Correspondence to THE AMERICAN ARCHITECT)

CHICAGO—After being deadlocked for a period of more than six weeks, the Chicago building industry has resumed activity, thanks to the magic influence of Judge Kenesaw Mountain Landis, who has been appointed arbiter of the wage dispute between the building trades and the associated contractors. Judge Landis, it is generally known, is a man of many talents. He made a name for himself many years ago by fining the Standard Oil Company \$29,000,000, has been a fearless and great justice of a federal court and more recently achieved much new fame by being selected as the chief arbiter of organized baseball. He adds the building arbitration to his onerous duties because after debating for a week or more the opposing sides of the deadlock were unable to agree upon any other man to whom the question might be delegated. When Judge Landis was mentioned both sides concurred eagerly and as this is being written, the versatile jurist is all set to cut the Gordian knot in his own characteristic manner. The first announcement from Judge Landis is to the effect that the hearings will be public.

Although the hearings will begin very shortly, a preliminary order has gone out that building be resumed and at this time, the sound of the hammer is beginning to be once more heard in the land. It is estimated that something like \$100,000,000 in unfinished construction has been held up by the deadlock and that a new wage scale may open the way for a much more general resumption of activity.

While the news of the conclusion of the deadlock is more or less cheering in its nature, much will depend upon the nature of Judge Landis' decision. True, all hands have agreed to abide the decision whatever it may be, but a wage scale unreasonably high would probably have the effect of checking building because the building public is now in a mood to await lower costs all around—in labor as well as in materials. The present scale is \$1.25 per hour for skilled labor and \$1.00 per hour for unskilled labor. This is considered much too high by

builders and it is considerably higher than the scale in surrounding cities. Just where the new decision will place the scale is a matter of utter conjecture, but even the most sanguine of the union leaders expect to see from a 15% to 20% cut.

The matter of labor costs is just one of the stumbling blocks in the path of building, however, and its settlement does not leave the way clear by any manner of means. A more serious difficulty is the great mass of graft and corruption which has been made unpleasantly public by the joint legislative committee which has been probing deeply into the Chicago building situation for several weeks. This committee known as the Dailey Committee, from the name of its chairman, has found that no recent building of importance has been conducted in Chicago without important tribute to labor grafters from the union ranks. Banks, hotels, theatres, even the churches, have been compelled to kick in under one guise or another. Out of the investigation has grown a long list of indictments, none of which, however, has yet come to trial. Whether convictions ultimately result is a matter of doubt, but the unmistakable fact is evident that the Chicago public is now very critically inclined on the subject of building. With the evidence of graft so easy to obtain, a number of important structures are being delayed. There must be a considerable purification of the atmosphere before the big investors in Chicago building projects will forget the recent exposures.

The one item of construction that has escaped the Scylla and Charybdis of the labor deadlock and the graft expose, has been the relatively small matter of residential construction in suburban locations. These home buildings have gone forward with rather creditable regularity with the result that practically every Chicago suburb now has houses for sale. They are being rather eagerly snapped up by rent-weary citizens who are willing to brave the terrors of a commuter's uncertain existence rather than read the new lease from an over-zealous landlord.

AN attempt is being made to accelerate the building of residences in outlying sections of the city by the removal of the fire restrictions governing the construction of houses. The lumber industry of the city doing what it can in favor of such a movement, but opposition is being manifested by brick manufacturers, real estate men and architects and the question is therefore being delayed as to its settlement.

Chicago architects have been actively engaged against any let-down of building restrictions and the arguments of the architects are being given more credence constantly. Stock of architects has gone up a hundred per cent. recently by reason of the fact that, thus far, the building graft revelations have not put any important blots of local architectural

THE AMERICAN ARCHITECT

escutcheons. Emboldened by their better standing Chicago architects are essaying to advise the public on many issues not formerly within the official purview of the architect. For instance, the Illinois Society of Architects has recently issued a manifesto urging the contractors of Chicago to institute an open shop policy in the matter of labor. The opening of negotiations under the supervision of Judge Landis developed in time, however, to prevent very serious consideration of the proposal.

The building permits for the month of May showed the effects of the building deadlock, although the month was much more active than May of 1920. A comparison of the permits for May, 1920, April, 1921, and May, 1921, is as follows:

Class	May 1920	April 1921	May 1921
Residences	144	346	255
Apartments	5	57	95
Industrial	131	111	61
Others	16	19	12
Totals	296	533	423

In the matter of prices of lumber and other building materials there have been no important changes, though the tendency during the past few weeks has been gradually downward. Among the important changes has been the recent announcement of a further reduction in wallboard by one of the important producers. The latest cut of \$3 per 1,000 square feet is the third since December, the total reduction being around \$11. The demand for lumber is nominal and it will require a more general resumption of building to establish stable prices.

BUILDING CONDITIONS on the PACIFIC COAST

(Special Correspondence to THE AMERICAN ARCHITECT)

SEATTLE—There has been a better tone in building materials, and with certain steel essentials falling in price, lumber at the bottom and a revision of selling methods, jobbers in construction materials assert that there are prospects for a strong summer and fall building season.

Probably the most definite constructive feature is the cement market. Manufacturers of the coast are practically booked ahead for several months on the road building program and are indifferent to quoting for the building trade. As a result jobbers are making inquiries in Belgium for cement, have received and tested samples, and according to prices c. i. f. Seattle will be able to get as good a cement as that produced here and make a good profit.

Conferences between department heads and road men have been held at Pacific coast headquarters during the past two weeks, and new instructions are to look out for the customary "no" when selling building materials, the grounds being that the trade

is so accustomed to looking on the dark side of the picture that to say "no" when asked to buy has become a habit. Salesmen were directed to look over the stocks for depleted lines and to talk up sales from that standpoint. Salesmen who received these instructions ten days ago are reporting amazing progress in getting orders, and other field reports show that similar results will follow all over the territory.

Building operations are beginning in the country. Farmers are getting higher offers for their product than seemed possible 90 days ago, and season's contracts are being closed for the product of entire apple orchards and hay fields. It has been the opinion of jobbers in building materials here that building revival of the nation must originate in the country, and this seems now to be coming true. Farmers have been more interested since nails declined 25c. per hundred pounds.

There is a fair movement of sheet metals, but galvanized pipe is slow due to the fact that builders are not buying ahead but are following up the plumbing angle closely with the superstructure. Fire brick has eased off and the tendency is downward in roofing and plaster wall board.

Generally, the outlook has improved much over the coast territory since a month ago. The increased movement is slow, but there have been no setbacks, and the enquiry is greater than in May.

THE fir lumber market is steady. Logs have declined, but logging operations in the North Coast territory are to be suspended in increasing degree until July 4. Cedar logs are so scarce that raw products have been imported from British Columbia. Shingles therefore are higher.

Governor Lonis F. Hart, sensing the universal demand for reductions in taxes in Washington, will support any plan that makes for systematic reductions. He has called a conference of all taxation bodies of the state.

Architect John K. Dew of Spokane, Wash., has been commissioned to draft and design a new \$100,000 concrete wholesale house at Wenatchee, Wash., one of the larger interior cities.

A modern fireproof hospital building 255x200 feet and four stories with an estimated cost of \$500,000 has been planned by Beezer Bros., of Seattle, for the Sisters of St. Joseph of Peace at Wenatchee, Wash. The building will be constructed in three units, the first of which is to go under construction at once at a cost of \$100,000. Work will start July 1. Preference will be given for materials to Wenatchee jobbers.

One of the largest consignments of glass ever shipped from Antwerp to the Pacific coast will be discharged at the Port of Seattle on the arrival of the steamship West Kedron with 8,326 tons of Belgian glass. Portions of the cargo will be discharged at all leading Pacific ports.

DEPARTMENT of SPECIFICATIONS

BEGINNING with this issue *THE AMERICAN ARCHITECT* inaugurates and will maintain a specification department. It has long been felt by the editors of this journal that the subject of specifications has not generally received the attention either of architectural publications or architects, that its importance deserved, and it is to assist in the correction of this condition that this new department is being established. Obviously, no department of a publication can be a success without reader-interest, and it is hoped that the material presented will quickly develop such an interest on the part of subscribers as will be an inspiration to the editors. Coincident with the inauguration of this feature in *THE AMERICAN ARCHITECT* is presented the initial installment of material furnished by the American Specification Institute, and it is expected that these two departments will, to a considerable extent, supplement each other.

THE EDITORS.

SPECIFICATIONS for building construction and equipment are increasing in importance as the complexity of the work embraced by them becomes more intricate by reason of the advance in the methods of construction and the greater variety of materials that are available for the work. While it is true that each architect attempts to prepare his specifications in a very careful manner so that they will not involve him in controversies inimical to his or his client's welfare, it must be recognized that the foundation for the preparation of specifications is not always what it should be.

In a great many instances more attention has been given to the production of drawings exhibiting excellent design and delineation than in many cases fail to give the basis for complete specification co-operation, than has been given to the "design and delineation" of specifications. The specification must not be too involved or too ponderous in volume; otherwise the very necessity for preparing a great number of specification pages may present to the architect, in his haste to get them in the hands of contractors, such a formidable volume of work that he would easily be tempted to rework an old specification which may have numberless errors and that may in many cases have no application at all to the work for which it is published.

EACH architect who has made a serious study of the art of specification writing and who has attempted to produce documents that will specify and obtain for him and for the owner the result contemplated by the drawings has pretty well fixed in his mind the groundwork he requires in order to assemble the component parts so that a good specification will result. It must be recognized that a really good specification cannot be produced with a

poor set of drawings, that is, a set of drawings that fail to exhibit those things that the specifications cannot possibly describe or explain in any manner.

One of the most essential points in the preparation of specifications is the very careful supervision of the preparation of working drawings, having in mind the matters and things that the specification will include, so that complete co-operation between the two sets of documents may be accomplished. It must be borne in mind that the constructor and his estimator have in these two sets of documents two systems for presentation to them of the work it is hoped they will accomplish: first, the drawings must bring to the intelligence of the constructor through his visual perception the kind of work that is to be done and the methods by which it is to be accomplished; and, second, the specifications will be understood by the constructor by the reading of the written word and a mind perception of those things that the specification describes. A complete recognition of these qualities inherent in the construction document will enable the specification writer to prepare his specifications and to see that the drawings are prepared in the correct manner. If the mind impressions gained by seeing and reading coincide, it would indicate that there is complete correlation between the two and that there should be very little difficulty in securing a happy accomplishment of the work.

The writing of specifications should be given just as important a place in the architect's office as structural design. There seems to be no reason for the average architect to dispute this except that his ignorance of their importance or of how to write them correctly is more profound than his understanding of their real function.

An architect surely cannot be ignorant of the im-

THE AMERICAN ARCHITECT

portance of specifications if he reads the various architectural, engineering and construction magazines and makes mental note of the many citations of legal decisions where the court was called on to interpret or rectify vague, meaningless or unjust specifications. Nor should an architect be ignorant of the correct method of writing the specifications if he spends a fraction of the time on their study that he spends in studying the design or structural framework of a building.

A proper recognition of the importance of correct specifications will not permit hasty preparation after the drawings are completed, but will require that they be started while the drawings are in progress and then completed several days after the drawings are ready for issue. Haste in preparing written matter tends to confusion, omission of important items and ambiguity.

A STUDY of specifications of various offices throughout the country has revealed a wanton carelessness and an amazing ignorance of all those qualities that should be embodied in a perfect document. They may be slipshod, unfair in treatment of the contractor, inaccurate, ambiguous and devoid of those qualities that permit analysis. But whatever fault lies within them it is usually a reflection of the attitude of their author that anything that is bound together and looks like a specification must, *per se*, be one.

The specification writer, whether he is engaged in that work only or whether he is the busy architect burdened with executive duties, must have an orderly mind and a habit of learning how and why things are done the way they should be done. Neatness, orderliness and meticulous habit with respect to the business in hand cannot fail to engender those qualities so essential to the writing of good specifications, namely, clearness, conciseness and coherence.

A strict adherence to these qualities is absolutely essential to preparing written discourse. And what is a specification if it is not the architect talking to the contractor, telling him the what, how and where of all component parts of the building he has designed,—a consecutive speech on a given line of thought?

If a specification is made interesting to its reader, who, after reading it, will be able to tell his foreman or superintendent what its message is, then that specification is a good one, an excellent one and indicative of a clever author. It may seem impossible to write such a specification, but it can be done if the proper study has been made of the work involved.

The specification writer should be one who has been a draftsman, a detailer, somewhat of an engineer, a superintendent of construction and a constant student of current technical literature and text books. All of these qualities are essential, forming, as they do, a combination of elements that

enter into the preparation of specifications of the better class. If one lacks experience in any of the branches of architectural practice or is disdainful of the necessity for constant study, he is not possessed of the proper qualities for specification writing. Each one supplements the other and together they make up the sum of knowledge brought to bear on the problems encountered in the work.

As the sum of one's knowledge is more often that which has been gained from others rather than that which has been gained through personal experiences, it is essential that the numerous architectural, engineering and mechanical equipment magazines and text books be studied constantly, for what better friends can a specification writer have than those who contribute to the magazines or prepare text books?

A HABIT of study will develop the ability to separate the wheat from the chaff and thus the student will read only those articles that concern him or his field of work if he is extremely busy or if the study proves to be an onerous task.

The "tools" that should be available to the specification writer should consist of a catalog file, data file, completed specifications file, a "master specification," a comprehensive outline and a well-prepared set of drawings.

The catalog file should contain all trade or material catalogs illustrative and descriptive of various parts, fittings and equipment. The catalogs should be filed alphabetically and according to the name of manufacturer and dealer rather than according to subject matter. This is by far the most simple and easily handled arrangement of the file. A small card index with all requisite cross-indexing will control the file and make all matter readily available.

The data file should contain all standard specifications of the American Society For Testing Materials, other standards of workmanship or material prepared by manufacturers that do not properly belong in the catalog file and the many interesting articles to be found in magazines that deal with quality of material and methods of construction or installation. This file should be arranged alphabetically and according to classification of subject matter, cross-indexed by a card system. The alphabetical letter should be given major numbers and the various subject subdivisions minor numbers somewhat on the order of the Dewey Decimal System.

The data file, if intelligently arranged and kept up to date, will prove to be of great value, for it will be found to organize the voluminous printed matter on materials and methods of construction that is constantly available to all.

A file of specifications that have been written in the past should be kept at hand, as they will be referred to constantly. During the construction of a building, if it is discovered that a paragraph could have been written more clearly or more concisely or

THE AMERICAN ARCHITECT

if a method outlined has been found to be incorrect or not suitable, a note should be placed in the specification at fault and reference made to the master specification described later. No specification can be considered perfect until it has passed through the fire of construction work and all its faults, if there be any, revealed to the author. By means of such notes there should be no possibility of repeating the mistakes made in that specification and in a short time the number of errors will be very small.

A master specification should be arranged as if it were a complete specification for a building, and in it should be placed all paragraphs that are used repeatedly and consequently become somewhat standardized. Any specification for an unusual item, such as steel pipe cofferdams, watertight bulkhead doors, or similar matter that has been studied carefully and can well be made a standard should be placed in this file. It will be found that a loose-leaf book, in which may be pasted the various matters belonging therein, will be convenient and permit of constant change with ease and quickness.

A comprehensive outline for specifications is a most desirable help, and while its preparation may appear onerous and a task that is subject to procrastination, it should be prepared very carefully. This outline will be a list of all items that must be mentioned in the specification for any particular building and must be subdivided and cross-indexed in a careful manner. As each office usually confines its work to a small number of classes of buildings, the outline should be prepared with the office practice in view, without spending time on matter for buildings that may never come into the office.

The outline not only will serve as a check for specification work but also a check when studying the drawings. As the specification writer usually is the last man to look over the drawings and as he approaches them from an angle differing from that of the draftsmen, he undoubtedly will discover errors, discrepancies or omissions that should be rectified. The outline will greatly facilitate all checking and analysis work and through its constant use can be changed and improved repeatedly.

WHILE studying the drawings before taking up the actual task of writing the specifications the mind must assert its analytical powers and those qualities that will lift the drawings from the two-dimensional plane of tee square and triangle to the three dimensions of true perspective. The drawings must be analyzed so that the specifications may be co-ordinated with them, so that they will describe those matters not fully covered by the drawings and will omit descriptions shown, or that should be shown by the drawings. The specification must not be a catalog of those things shown on the drawings, but must be a descriptive narrative, including matter the drawings cannot show, so that the structure will appear in its proper aspect and reveal certain methods of construction or certain things to be done that will not be so evident on the line drawing itself.

While analyzing the drawings an outline of general items peculiar to the building should be made, to be marked later in the general outline mentioned above. Copious notes can well be made at this stage of the work, for it will be found that the mere writing of the notes will tend to fix their nature and import in the mind.

When the specification is to be started the various branches such as Wrecking, Excavation, etc., should be listed and given numbers, thus: Section 1—Wrecking, Section 2—Excavation, Section 3—Concrete Masonry, Section 4—Reinforcing Steel, Section 5—Structural Steel, Section 6—Brick Masonry, arranging the various sections as near in the order of the activities at the building as possible.

Then an outline should be made for each section, making reference to the general outline for the usual standard matters and arranging in proper sequence the items peculiar to the building.

Bear in mind always that if the specification is written so that the activities described therein are in sequence as they occur in the actual construction work, the clearness of the specification will not fail to be evident, for then the building will actually grow in the mind of the reader.

ANNOUNCEMENT by BOARD of GOVERNORS AMERICAN SPECIFICATION INSTITUTE

SINCE the announcement in the columns of THE AMERICAN ARCHITECT of the organization of The American Specification Institute there has been a very gratifying response to the appeal for members. This response indicates a necessity for the careful and orderly study of the many problems involved in the preparation of specifications and equipment and that there is a very great appreciation of the importance of specifications of merit.

All those who have been attempting to improve the writing of specifications have discovered that there are very few text books on the subject and none that will give practical assistance in the preparation of a complete document. The basic idea of the founders of The American Specification Institute has been that such a text book is quite essential to a thorough understanding of the science of specification writing and that surely there can be no better authors of such a work than those specification writers who are intimately conversant with the problems involved.

The Institute proposes to produce such a text book as one of its main services to its membership. Each member is expected to contribute to the task according to his best ability so that he will have at his disposal the combined thought of the entire Institute membership.

PUBLICATION of the various activities of the Institute will be through the medium of frequent bulletins in conjunction with reports of current activities, etc., published in THE AMERICAN ARCHITECT. The bulletins will be of uniform size, so that they may be bound in loose-leaf covers, available for immediate use. Data of all kinds relating to specification work, reports of all committees and reprints from technical or other magazines will all form a part of this handbook, so that eventually it will become the specification writer's "Bible."

It seems proper at this time to republish the Plan and Scope of The American Specification Institute, as it explains in a concise manner the scheme of activities contemplated.

The names of the Board of Governors and the general list of members, as of June 10th, are as follows:

Chester L. Post, member of Condron Company, Consulting and Structural Engineers, Chicago.
Frank A. Randall, member of Berlin, Swern and Randall, Architects and Engineers, Chicago.
Arthur T. North, Architect and Engineer, Chicago.

Gardner C. Coughlen, Architect, Chicago.
H. Kenneth Franzheim, Architect, Chicago.
Meyer Fridstein, Architect and Engineer, Chicago.
L. O. Kirk, Architect and Engineer, Minneapolis.
Samuel Hannaford & Sons, Architects, Cincinnati.
C. Howard Crane, Architect, Detroit.
M. H. Johnson, Jr., Architect, Terre Haute.
Prof. L. H. Provine, University of Illinois, Urbana.
Ralph B. Higgins, Architect and Engineer, New York City.
Mauran, Russell & Crowell, Architects, St. Louis.
R. M. Stubbs, Bridge Engineer, St. Louis.
Franklin H. Coney, Consulting Engineer, Chicago.
Frederick A. Muhlenberg, Architect, Philadelphia.
A. G. Zimmerman, Architect, New York City.
John V. Bennes, Architect, Portland.
John S. Archibald, Architect, Montreal.
Ellery Davis, Architect, Lincoln.
Tourtellotte & Hummel, Architects, Boise.
Smith, Hinchman & Grylls, Architects and Engineers, Detroit.
Sanguinet & Statts, Architects, Fort Worth.
Garber & Woodward, Architects, Cincinnati.
W. S. Hays, Architectural Engineer, Chicago.
Frank Irving Cooper Corp., Architects and Engineers, Boston.
Prof. James M. White, University of Illinois, Urbana.
Hatton, Holmes & Anthony, Architects, Cedar Rapids, Iowa.
A. Lincoln Fechheimer, Architect, Cincinnati.
F. S. Schwinn, Engineer, Houston.
C. B. J. Snyder, Architect, New York City.
Walter F. Ballinger, Architect and Engineer, Philadelphia.
Harry B. Wheelock, Architect, Birmingham.
Alexander C. Eschweiler, Architect, Milwaukee.
Ludlow & Peabody, Architects, New York City.
Albert Kahn, Architect and Engineer, Detroit.
James Gamble Rogers, Architect, New York City.
A. A. Aegerter, Architect, St. Louis.
Waddell & Son, Consulting Engineers, Kansas City.
John Galen Howard, Architect, San Francisco.
R. J. Needham, Mech. and Elec. Engineer, Montreal.
Edwards & Sayward, Architects, Atlanta.
Prof. Goldwin Goldsmith, University of Kansas, Lawrence.

THE AMERICAN ARCHITECT

Prof. W. K. Hatt, Purdue University, Lafayette.
F. E. Davidson, Architect and Engineer, Chicago.
C. W. Koehler, Engineer, Chicago.
Henry Calder Thorne, Architect, Ithaca.
Walter Martin Kedian, Architect, Cleveland.
Edward Woods Husband, Architect, Providence.

Hugh Y. Davis, Architect and Engineer, Stockton, Calif.
Eldon L. Boots, Architect, Ames, Iowa.
Morris B. Payne, Architect, New London, Conn.
Hugh Borland, Structural Engineer, Chicago.
C. M. Vester, Architect, Wheeling.

PLAN and SCOPE of The AMERICAN SPECIFICATION INSTITUTE

AS heretofore produced specifications have been largely the product of individual effort and as such have varied in many features that can be conventionalized so as to be common to all. Owing to a present lack of means for collecting and distributing information concerning specifications and the writing thereof, there is a needless duplication of study, research and labor on the part of specification writers. Practically all other professions are so organized that the interchange of knowledge is effected with resulting improvement in the quality of production and professional standing. It is to improve the conditions affecting the writing of specifications and to benefit by organized effort that THE AMERICAN SPECIFICATION INSTITUTE is organized. This organization is intended to be national in scope and invites co-operation of all those interested in specifications. The plan and scope of this organization follows:

I. PURPOSE

1. To increase knowledge concerning and improve the methods of writing specifications. The kinds of specifications included are those for buildings, engineering structures and all works whatsoever in which materials of construction and labor are used; for the installation and use of mechanical and sanitary apparatus and equipment; for the fabrication and installation of all furnishings and furniture; for all ornaments and ornamentation, both interior and exterior; for paving, planting, embellishing and improving of grounds and waterways; and for such other things as are produced or sold on specifications.
2. The Institute will not interfere with any of the present organizations such as:
 - a--The American Society for Testing Materials
 - b--Kindred national and local architectural and engineering societies
 - c--Manufacturers' and trade associations, but will endeavor to carry forward the

activities of such and give additional assistance to specification writers.

II. BENEFITS TO BE OBTAINED

The architectural and engineering professions will gain through

- a--The development of specification writers
- b--The development of specifications that will eliminate cause for argument and guesswork and lower the cost of building construction by eliminating waste of labor and materials
- c--Professional recognition of specification writers.

III. MEMBERSHIP

Will be composed of

1. ACTIVE MEMBERS

a--Persons who devote their entire time or a part thereof to the writing of specifications

2. ASSOCIATE MEMBERS

a--Testing and laboratory engineers

b--Instructors in specification writing in architectural and engineering schools.

3. HONORARY MEMBERS

Persons who have rendered distinguished service to the art or science of specification writing.

4. PATRONS

Persons who contribute to the financial support of the Institute.

IV. ORGANIZATION

a--Will be governed by a constitution and set of by-laws

b--The secretary will direct the activities of all researches, co-operation with other societies, etc., and will secure and provide answers to all inquiries of the members.

V. ACTIVITIES OF ORGANIZATION

1. Study of materials

THE AMERICAN ARCHITECT

- a—The production and physical properties of raw materials
 - b—Methods of manufacturing, fabrication and finishing
 - c—Relative value based on appearance, initial cost and maintenance, effect of combinations with other materials and proper materials for various types of buildings of varying grades.
2. Methods of writing specifications
- A study will be made of:
- a—The means of accomplishing complete co-operation between the drawings and specifications and determining
 - What methods of construction and installation should be used;
 - What the drawings should show or indicate;
 - What should be omitted for inclusion in the specifications;
 - b—The development of an outline or checking list
 - c—The general contract conditions.
 - d—Specific requirements governed by local conditions
 - e—Use of Standard Specifications of materials as prepared by societies and manufacturers
 - f—The arrangement of specifications so as to conform to the sequence of construction and installation of work
 - g—The writing of specifications that are clear, concise, coherent and that can be understood by the courts
 - h—The principles of contract law as it affects the writing of specifications
 - i—Possible standardization of building codes
3. The securing of the adoption of recommended practices by the professions and others concerned.
4. The deliberations of the Institute, discus-

sions, treatises by members or invited contributors and other matters will be published.

THE Board of Governors has been so impressed with the necessity for a comprehensive outline for use in preparing specifications that it has determined immediately to make a study of this important subject. The first bulletin on this subject has already been distributed to members and, members who have not already done so, are requested to give it their earnest attention and send to the Secretary suggestions and criticisms; if they have none, then their approval.

This bulletin contains a general outline of the various branches of work that a specification must cover. Subsequent bulletins will carry comprehensive outlines of each branch and it is hoped that every member will endeavor to make these bulletins the subject of earnest study on his part to the end that the final documents will represent the combined thought of the entire membership.

The Executive Secretary's office is accumulating a vast amount of data, catalogs and standard specifications of all kinds and will be glad to answer, or obtain an answer to, any inquiry from members. Members are urged to send to the office of the Executive Secretary all data which may be of benefit to other members and to assist in every way in the formation of a complete library on specifications.

Very shortly discussions on the history of materials, their production, fabrication or manufacture, finish and economical uses will be made the subjects of bulletins. This matter is now in preparation. As it will cover a great many materials, it will prove to be one of the most interesting and instructive services of the Institute.

All inquiries should be addressed to The American Specification Institute, 127 North Dearborn Street, Chicago, Illinois.

THE AMERICAN SPECIFICATION INSTITUTE,
Gardner C. Coughlen,
Acting Executive Secretary.

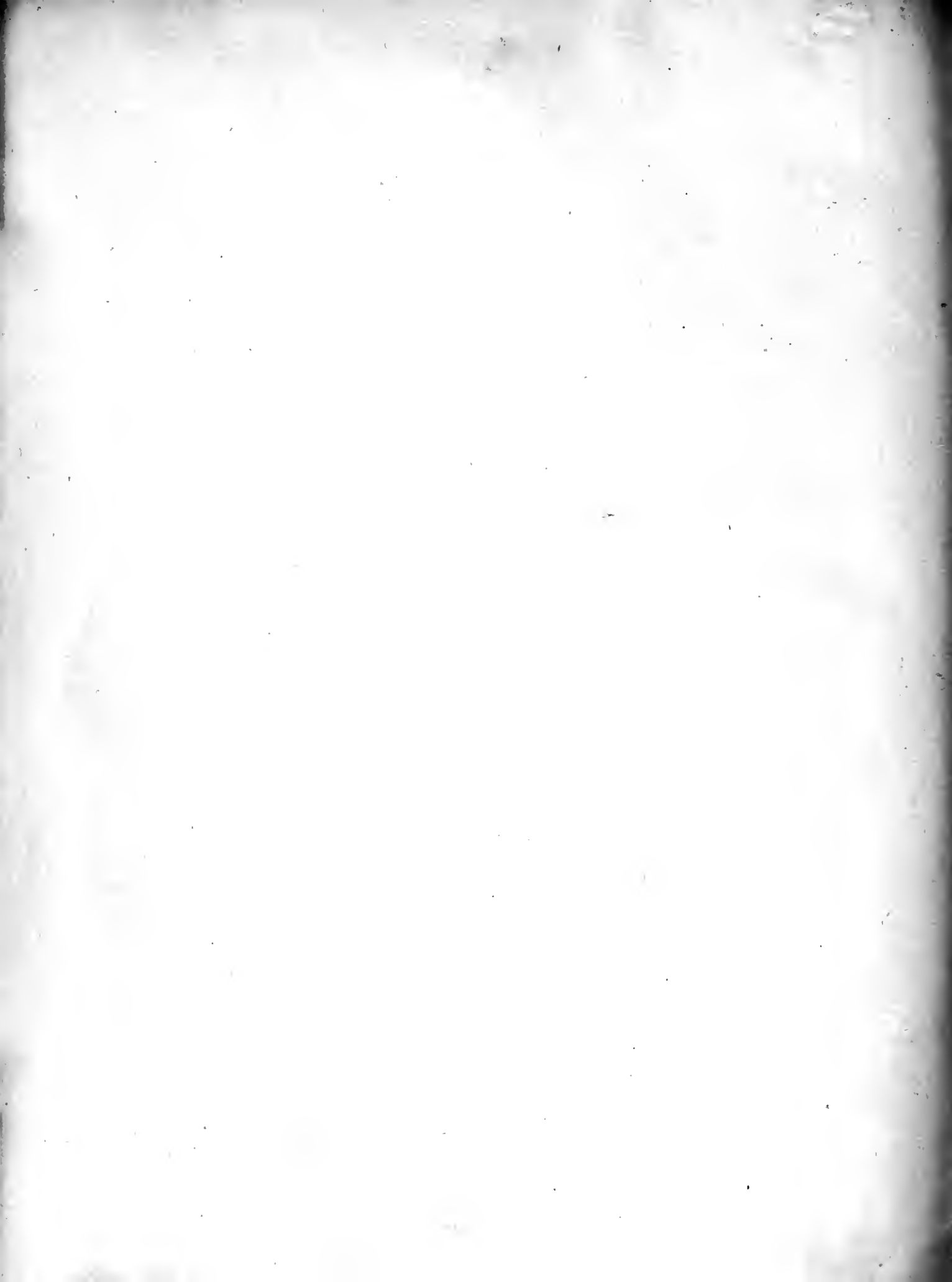

NA
1
A322
v.119

American architect and
architecture

PLEASE DO NOT REMOVE
CARDS OR SLIPS FROM THIS POCKET

UNIVERSITY OF TORONTO LIBRARY

